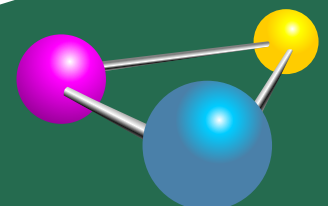


**Version  
4.6**

*Supports Android  
2.x - 4.2 and  
the R21 Tools!*

# The Busy Coder's Guide to Android Development

Mark L. Murphy



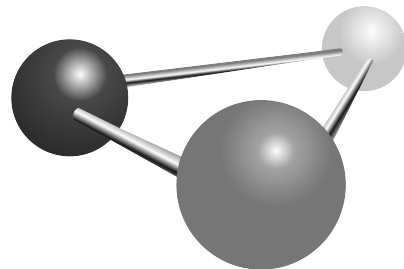
COMMONSWARE

---

# The Busy Coder's Guide to Android Development

---

*by Mark L. Murphy*



**COMMONSWARE**

## **The Busy Coder's Guide to Android Development**

by Mark L. Murphy

Copyright © 2008-2013 CommonsWare, LLC. All Rights Reserved.

Printed in the United States of America.

Printing History:

February 2013:    Version 4.6        ISBN: 978-0-9816780-0-9

The CommonsWare name and logo, “Busy Coder's Guide”, and related trade dress are trademarks of CommonsWare, LLC.

All other trademarks referenced in this book are trademarks of their respective firms.

The publisher and author(s) assume no responsibility for errors or omissions or for damages resulting from the use of the information contained herein.

# Table of Contents

---

Headings formatted in *bold-italic* have changed since the last version.

- [Preface](#)
  - Welcome to the Book! ..... xxvii
  - The Book's Structure ..... xxvii
  - ***The Trails*** ..... **xxviii**
  - About the Updates ..... xxxii
  - Warescription ..... xxxiii
  - Getting Help ..... xxxiii
  - Book Bug Bounty ..... xxxiii
  - ***Source Code And Its License*** ..... **xxxiv**
  - Creative Commons and the Four-to-Free (42F) Guarantee ..... xxxv
  - Acknowledgments ..... xxxv
- [Key Android Concepts](#)
  - Android Applications ..... 1
  - ***Android Devices*** ..... **7**
  - Don't Be Scared ..... 10
- [Choosing Your IDE](#)
  - Eclipse ..... 11
  - Alternative IDEs ..... 12
  - IDEs... And This Book ..... 13
  - About App Inventor ..... 13
- [Tutorial #1 - Installing the Tools](#)
  - Step #1 - Checking Your Hardware Requirements ..... 15
  - Step #2 - Setting Up Java ..... 16
  - ***Step #3 - Install the Android SDK*** ..... **16**
  - Step #4 - Install the ADT for Eclipse ..... 19
  - Step #5 - Install Apache Ant ..... 21
  - Step #6 - Set Up the Emulator ..... 22
  - ***Step #7 - Set Up the Device*** ..... **29**
  - In Our Next Episode... ..... 32
- [Tutorial #2 - Creating a Stub Project](#)
  - About Our Tutorial Project ..... 33
  - About the Rest of the Tutorials ..... 34
  - About the Eclipse Instructions ..... 34
  - ***Step #1: Creating the Project*** ..... **35**
  - Step #2: Running the Project ..... 41

- In Our Next Episode... ..... 45
- [Contents of Android Projects](#)
  - Root Contents ..... 47
  - The Sweat Off Your Brow ..... 48
  - Resources ..... 48
  - What You Get Out Of It ..... 49
- [Inside the Manifest](#)
  - An Application For Your Application ..... 53
  - Specifying Versions ..... 53
  - Supporting Multiple Screens ..... 54
  - Other Stuff ..... 55
- [Tutorial #3 - Changing Our Manifest](#)
  - **Step #1: Supporting Screens** ..... 57
  - Step #2: Validating our Minimum and Target SDK Versions ..... 61
  - In Our Next Episode... ..... 63
- [Some Words About Resources](#)
  - **String Theory** ..... 65
  - **Got the Picture?** ..... 69
  - Dimensions ..... 72
  - The Resource That Shall Not Be Named... Yet ..... 73
- [Tutorial #4 - Adjusting Our Resources](#)
  - Step #1: Changing the Name ..... 75
  - **Step #2: Changing the Icon** ..... 77
  - In Our Next Episode... ..... 85
- [The Theory of Widgets](#)
  - What Are Widgets? ..... 87
  - Size, Margins, and Padding ..... 89
  - What Are Containers? ..... 89
  - **The Absolute Positioning Anti-Pattern** ..... 90
- [The Android User Interface](#)
  - The Activity ..... 93
  - Dissecting the Activity ..... 94
  - **Using XML-Based Layouts** ..... 95
- [Basic Widgets](#)
  - Common Concepts ..... 101
  - Assigning Labels ..... 103
  - A Commanding Button ..... 108
  - **Fleeting Images** ..... 111
  - Fields of Green. Or Other Colors. .... 116
  - More Common Concepts ..... 119
  - Visit the Trails! ..... 121

- [Debugging Crashes](#)
  - Get Thee To a Stack Trace ..... 124
  - The Case of the Confounding Class Cast ..... 127
  - Point Break ..... 127
- [LinearLayout and the Box Model](#)
  - Concepts and Properties ..... 129
  - Eclipse Graphical Layout Editor ..... 133
- [Other Common Widgets and Containers](#)
  - Just a Box to Check ..... 135
  - Don't Like Checkboxes? How About Toggles? ..... 138
  - Turn the Radio Up ..... 140
  - **All Things Are Relative** ..... 142
  - Tabula Rasa ..... 149
  - Scrollwork ..... 153
  - Making Progress with ProgressBars ..... 156
  - Visit the Trails! ..... 157
- [Tutorial #5 - Making Progress](#)
  - **Step #1: Removing The "Hello, World"** ..... 159
  - Step #2: Adding a ProgressBar ..... 161
  - Step #3: Seeing the Results ..... 163
  - In Our Next Episode... ..... 164
- [GUI Building, Continued](#)
  - Making Your Selection ..... 165
  - Including Includes ..... 165
  - Wrap It Up (In a Container) ..... 167
  - Morphing Widgets ..... 167
  - Preview of Coming Attractions ..... 168
- [AdapterViews and Adapters](#)
  - Adapting to the Circumstances ..... 169
  - Lists of Naughty and Nice ..... 171
  - Clicks versus Selections ..... 173
  - Spin Control ..... 177
  - Grid Your Lions (Or Something Like That...) ..... 180
  - Fields: Now With 35% Less Typing! ..... 183
  - Galleries, Give Or Take The Art ..... 188
  - Customizing the Adapter ..... 189
  - Visit the Trails! ..... 197
- [The WebView Widget](#)
  - Role of WebView ..... 199
  - WebView and WebKit ..... 200
  - Adding the Widget ..... 200

◦ Loading Content Via a URL .....	201
◦ Supporting JavaScript .....	203
◦ Alternatives for Loading Content .....	204
◦ Listening for Events .....	205
◦ Visit the Trails! .....	208
• <a href="#">Defining and Using Styles</a>	
◦ Styles: DIY DRY .....	211
◦ Elements of Style .....	213
◦ Themes: Would a Style By Any Other Name... .....	216
• <a href="#">JARs and Library Projects</a>	
◦ The Dalvik VM .....	218
◦ The Easy Part .....	218
◦ The Outer Limits .....	219
◦ OK, So What is a Library Project? .....	220
◦ Creating a Library Project .....	220
◦ Using a Library Project .....	221
◦ Limitations of Library Projects .....	222
◦ The Android Support Package .....	222
◦ JAR Dependency Management .....	225
• <a href="#">Tutorial #6 - Adding a Library</a>	
◦ <b>Step #1: Downloading and Unpacking ActionBarSherlock</b> .....	227
◦ <b>Step #2: Adding the Library to Your Project</b> .....	228
◦ In Our Next Episode... .....	231
• <a href="#">Options Menus and the Action Bar</a>	
◦ <b>Bar Hopping (a.k.a., Terminology)</b> .....	233
◦ Yet Another History Lesson .....	238
◦ <b>Your Action Bar Options</b> .....	239
◦ Setting the Target .....	243
◦ Minding Narrow .....	244
◦ Defining the Resource .....	244
◦ Applying the Resource .....	249
◦ Responding to Events .....	249
◦ Attaching to Action Layouts .....	250
◦ The Rest of the Sample Activity .....	250
◦ Floating Action Bars .....	258
◦ Visit the Trails! .....	261
• <a href="#">Tutorial #7 - Adding the Action Bar</a>	
◦ Step #1: Setting the Theme and Splitting the Bar .....	263
◦ Step #2: Changing to SherlockFragmentActivity .....	265
◦ <b>Step #3: Defining Some Options</b> .....	267
◦ Step #4: Loading and Responding to Our Options .....	269

- In Our Next Episode... ..... 273
- [Android's Process Model](#)
  - When Processes Are Created ..... 275
  - BACK, HOME, and Your Process ..... 276
  - Termination ..... 277
  - Foreground Means "I Love You" ..... 277
  - You and Your Heap ..... 278
- [Activities and Their Lifecycles](#)
  - Creating Your Second (and Third and...) Activity ..... 280
  - Warning! Contains Explicit Intents! ..... 285
  - Using Implicit Intents ..... 287
  - **Extra! Extra!** ..... **292**
  - Asynchronicity and Results ..... 294
  - Schroedinger's Activity ..... 294
  - Life, Death, and Your Activity ..... 295
  - When Activities Die ..... 297
  - Walking Through the Lifecycle ..... 298
  - Recycling Activities ..... 301
- [Tutorial #8 - Setting Up An Activity](#)
  - Step #1: Creating the Stub Activity Class ..... 303
  - Step #2: Adding the Activity to the Manifest ..... 305
  - Step #3: Launching Our Activity ..... 307
  - In Our Next Episode... ..... 308
- [The Tactics of Fragments](#)
  - The Six Questions ..... 309
  - Your First Fragment ..... 311
  - The Fragment Lifecycle Methods ..... 316
  - Your First Dynamic Fragment ..... 317
  - Fragments and the Action Bar ..... 321
  - Fragments Within Fragments: Just Say "Maybe" ..... 322
  - Fragments and Multiple Activities ..... 323
- [Tutorial #9 - Starting Our Fragments](#)
  - Step #1: Copy In WebViewFragment ..... 325
  - Step #2: Examining WebViewFragment ..... 329
  - Step #3: Creating AbstractContentFragment ..... 329
  - Step #4: Examining AbstractContentFragment ..... 331
  - In Our Next Episode... ..... 331
- [Swiping with ViewPager](#)
  - Swiping Design Patterns ..... 333
  - Paging Fragments ..... 334
  - Paging Other Stuff ..... 339



- Indicators ..... 339
- Fragment-Free Paging ..... 343
- Hosting ViewPager in a Fragment ..... 343
- [Tutorial #10 - Rigging Up a ViewPager](#)
  - **Step #1: Add a ViewPager to the Layout** ..... **345**
  - Step #2: Obtaining Our ViewPager ..... 346
  - Step #3: Creating a ContentsAdapter ..... 347
  - Step #4: Setting Up the ViewPager ..... 348
  - In Our Next Episode... ..... 349
- [Resource Sets and Configurations](#)
  - What's a Configuration? And How Do They Change? ..... 351
  - Configurations and Resource Sets ..... 352
  - Coping with Complexity ..... 353
  - Default Change Behavior ..... 355
  - Your Options for Configuration Changes ..... 357
  - Blocking Rotations ..... 369
- [Dealing with Threads](#)
  - The Main Application Thread ..... 371
  - Getting to the Background ..... 372
  - Asyncing Feeling ..... 373
  - Alternatives to AsyncTask ..... 381
  - And Now, The Caveats ..... 383
- [Requesting Permissions](#)
  - Mother, May I? ..... 386
  - New Permissions in Old Applications ..... 387
  - Permissions: Up Front Or Not At All ..... 388
  - Signature Permissions ..... 389
  - Requiring Permissions ..... 389
- [Assets, Files, and Data Parsing](#)
  - Packaging Files with Your App ..... 391
  - Files and Android ..... 393
  - **Working with Internal Storage** ..... **394**
  - **Working with External Storage** ..... **396**
  - Multiple User Accounts ..... 401
  - Linux Filesystems: You Sync, You Win ..... 401
  - StrictMode: Avoiding Janky Code ..... 402
  - XML Parsing Options ..... 409
  - JSON Parsing Options ..... 410
- [Tutorial #11 - Adding Simple Content](#)
  - Step #1: Adding Some Content ..... 411
  - Step #2: Create a SimpleContentFragment ..... 412

◦ Step #3: Examining SimpleContentFragment .....	413
◦ Step #4: Using SimpleContentFragment .....	413
◦ Step #5: Launching Our Activities, For Real This Time .....	414
◦ In Our Next Episode... .....	416
• <a href="#">Tutorial #12 - Displaying the Book</a>	
◦ Step #1: Adding a Book .....	417
◦ Step #2: Defining Our Model .....	418
◦ Step #3: Examining Our Model .....	420
◦ Step #4: Creating a ModelFragment .....	420
◦ Step #5: Examining the ModelFragment .....	423
◦ <b>Step #6: Supplying the Content</b> .....	<b>424</b>
◦ Step #7: Adapting the Content .....	425
◦ Step #8: Going Home, Again .....	427
◦ In Our Next Episode... .....	428
• <a href="#">Using Preferences</a>	
◦ Getting What You Want .....	429
◦ Stating Your Preference .....	430
◦ Introducing PreferenceActivity .....	431
◦ Types of Preferences .....	443
◦ Intents for Headers or Preferences .....	446
◦ Conditional Headers .....	447
◦ Option #2: Go Directly to the Fragment .....	449
• <a href="#">Tutorial #13 - Using Some Preferences</a>	
◦ Step #1: Adding a StockPreferenceFragment .....	454
◦ Step #2: Defining the Preference XML Files .....	455
◦ Step #3: Creating Our PreferenceActivity .....	457
◦ Step #4: Adding To Our Action Bar .....	458
◦ Step #5: Launching the PreferenceActivity .....	460
◦ <b>Step #6: Loading Our Preferences</b> .....	<b>463</b>
◦ Step #7: Saving the Last-Read Position .....	465
◦ Step #8: Restoring the Last-Read Position .....	466
◦ Step #9: Keeping the Screen On .....	466
◦ In Our Next Episode... .....	467
• <a href="#">SQLite Databases</a>	
◦ Introducing SQLite .....	469
◦ Thinking About Schemas .....	470
◦ Start with a Helper .....	470
◦ Getting Data Out .....	476
◦ The Rest of the CRUD .....	481
◦ Hey, What About Hibernate? .....	486
◦ Visit the Trails! .....	486

- [Tutorial #14 - Saving Notes](#)
  - Step #1: Adding a DatabaseHelper ..... 487
  - Step #2: Examining DatabaseHelper ..... 489
  - Step #3: Creating a NoteFragment ..... 490
  - Step #4: Examining NoteFragment ..... 491
  - **Step #5: Creating the NoteActivity** ..... **492**
  - Step #6: Loading and Saving Notes ..... 493
  - Step #7: Add Notes to the Action Bar ..... 497
  - **Step #8: Support Deleting Notes** ..... **499**
  - In Our Next Episode... ..... 507
- [Internet Access](#)
  - DIY HTTP ..... 509
  - HTTP via DownloadManager ..... 520
  - Using Third-Party JARs ..... 521
  - **SSL** ..... **521**
- [Intents, Intent Filters, Broadcasts, and Broadcast Receivers](#)
  - What's Your Intent? ..... 529
  - Stating Your Intent(ions) ..... 531
  - Responding to Implicit Intents ..... 532
  - Requesting Implicit Intents ..... 534
  - Broadcasts and Receivers ..... 538
  - Example System Broadcasts ..... 540
  - **Downloading Files** ..... **547**
  - Keeping It Local ..... 559
- [Tutorial #15 - Sharing Your Notes](#)
  - Step #1: Adding a Share Action Bar Item ..... 563
  - Step #2: Sharing the Note ..... 564
  - Step #3: Tying Them Together ..... 565
  - Step #4: Testing the Result ..... 565
  - In Our Next Episode... ..... 566
- [Services and the Command Pattern](#)
  - Why Services? ..... 567
  - Setting Up a Service ..... 568
  - Communicating To Services ..... 570
  - Scenario: The Music Player ..... 572
  - Communicating From Services ..... 575
  - **Scenario: The Downloader** ..... **577**
- [Tutorial #16 - Updating the Book](#)
  - Step #1: Adding a Stub DownloadCheckService ..... 584
  - Step #2: Tying the Service Into the Action Bar ..... 585
  - Step #3: Adding a Stub DownloadCompleteReceiver ..... 586

- Step #4: Completing the DownloadCheckService ..... 587
- Step #5: Adding a Stub DownloadInstallService ..... 591
- Step #6: Completing the DownloadCompleteReceiver ..... 592
- Step #7: Completing the DownloadInstallService ..... 593
- Step #8: Updating ModelFragment ..... 595
- Step #9: Adding a BroadcastReceiver to EmPubLiteActivity ..... 598
- Step #10: Discussing the Flaws ..... 602
- In Our Next Episode... ..... 602
- [AlarmManager and the Scheduled Service Pattern](#)
  - Scenarios ..... 603
  - Options ..... 604
  - A Simple Example ..... 606
  - The Four Types of Alarms ..... 608
  - When to Schedule Alarms ..... 609
  - Get Moving, First Thing ..... 610
  - Archetype: Scheduled Service Polling ..... 613
  - Staying Awake at Work ..... 617
- [Tutorial #17 - Periodic Book Updates](#)
  - Step #1: Adding a Stub UpdateReceiver ..... 621
  - Step #2: Scheduling the Alarms ..... 623
  - Step #3: Adding the WakefulIntentService ..... 624
  - Step #4: Using WakefulIntentService ..... 625
  - Step #5: Completing the UpdateReceiver ..... 626
  - In Our Next Episode... ..... 626
- [Notifications](#)
  - What's a Notification? ..... 627
  - Showing a Simple Notification ..... 629
  - Notifications and Foreground Services ..... 634
  - **Seeking Some Order** ..... **635**
  - Big (and Rich) Notifications ..... 641
  - **Disabled Notifications** ..... **648**
- [Tutorial #18 - Notifying the User](#)
  - Step #1: Adding the InstallReceiver ..... 651
  - Step #2: Completing the InstallReceiver ..... 653
  - In Our Next Episode... ..... 654
- [Large-Screen Strategies and Tactics](#)
  - Objective: Maximum Gain, Minimum Pain ..... 655
  - The Fragment Strategy ..... 655
  - Fragment Example: The List-and-Detail Pattern ..... 664
  - Showing More Pages ..... 675
  - Fragment FAQs ..... 679

- Screen Size and Density Tactics ..... 680
- Other Considerations ..... 683
- [Tutorial #19 - Supporting Large Screens](#)
  - Step #1: Creating Our Layouts ..... 687
  - Step #2: Loading Our Sidebar Widgets ..... 691
  - Step #3: Opening the Sidebar ..... 692
  - Step #4: Loading Content Into the Sidebar ..... 692
  - Step #5: Removing Content From the Sidebar ..... 695
- [Backwards Compatibility Strategies and Tactics](#)
  - Think Forwards, Not Backwards ..... 697
  - Aim Where You Are Going ..... 699
  - A Target-Rich Environment ..... 699
  - A Little Help From Your Friends ..... 701
  - Avoid the New on the Old ..... 701
  - Testing ..... 705
- [Getting Help](#)
  - Questions. Sometimes, With Answers. .... 707
  - Heading to the Source ..... 708
  - Getting Your News Fix ..... 709
- [Introducing GridLayout](#)
  - Prerequisites ..... 711
  - Issues with the Classic Containers ..... 711
  - The New Contender: GridLayout ..... 713
  - GridLayout and the Android Support Package ..... 714
  - Eclipse and GridLayout ..... 715
  - Trying to Have Some Rhythm ..... 715
  - Our Test App ..... 716
  - Replacing the Classics ..... 718
  - Implicit Rows and Columns ..... 725
  - Row and Column Spans ..... 727
  - Should You Use GridLayout? ..... 731
- [Dialogs and DialogFragments](#)
  - Prerequisites ..... 733
  - DatePickerDialog and TimePickerDialog ..... 733
  - AlertDialog ..... 739
  - DialogFragments ..... 740
  - Dialogs: Modal, Not Blocking ..... 744
- [Advanced ListView](#)
  - Prerequisites ..... 747
  - Multiple Row Types, and Self Inflation ..... 747
  - Choice Modes and the Activated Style ..... 753

◦ Custom Mutable Row Contents .....	754
◦ From Head To Toe .....	760
• <a href="#">Action Bar Navigation</a>	
◦ Prerequisites .....	765
◦ List Navigation .....	765
◦ Tabs (And Sometimes List) Navigation .....	770
◦ Custom Navigation .....	776
• <a href="#">Action Modes and Context Menus</a>	
◦ Prerequisites .....	778
◦ Another Wee Spot O' History .....	778
◦ Manual Action Modes .....	779
◦ Multiple-Modal-Choice Action Modes .....	784
◦ Split Action Modes .....	788
◦ What Came Before: Context Menus .....	791
• <a href="#">Advanced Uses of WebView</a>	
◦ Prerequisites .....	795
◦ <i>Friends with Benefits</i> .....	<b>795</b>
◦ <i>Turnabout is Fair Play</i> .....	<b>801</b>
◦ Navigating the Waters .....	805
◦ Settings, Preferences, and Options (Oh, My!) .....	805
• <a href="#">The Input Method Framework</a>	
◦ Prerequisites .....	807
◦ Keyboards, Hard and Soft .....	807
◦ Tailored To Your Needs .....	808
◦ Tell Android Where It Can Go .....	812
◦ Fitting In .....	814
◦ Jane, Stop This Crazy Thing! .....	816
• <a href="#">Fonts</a>	
◦ Prerequisites .....	819
◦ Love The One You're With .....	819
◦ Here a Glyph, There a Glyph .....	823
• <a href="#">Rich Text</a>	
◦ Prerequisites .....	825
◦ The Span Concept .....	825
◦ Loading Rich Text .....	827
◦ Editing Rich Text .....	829
◦ Saving Rich Text .....	834
◦ Manipulating Rich Text .....	835
• <a href="#">Mapping with Maps V2</a>	
◦ Prerequisites .....	837
◦ A Brief History of Mapping on Android .....	838

◦ Where You Can Use Maps V2 .....	838
◦ Licensing Terms for Maps V2 .....	839
◦ What You Need to Start .....	839
◦ The Book Samples... And You! .....	843
◦ <b>Setting Up a Basic Map</b> .....	<b>843</b>
◦ Playing with the Map .....	849
◦ Placing Simple Markers .....	854
◦ Sprucing Up Your “Info Windows” .....	857
◦ <b>Setting the Marker Icon</b> .....	<b>862</b>
◦ Responding to Taps .....	864
◦ Dragging Markers .....	866
◦ <b>The “Final” Limitations</b> .....	<b>868</b>
◦ <b>A Bit More About IPC</b> .....	<b>872</b>
◦ Finding the User .....	873
◦ <b>Drawing Lines and Areas</b> .....	<b>876</b>
◦ Gestures and Controls .....	879
◦ Tracking Camera Changes .....	880
◦ Maps in Fragments and Pagers .....	882
◦ MapFragment vs. MapView .....	886
◦ <b>Maps and ActionBarSherlock</b> .....	<b>886</b>
◦ About That AbstractMapActivity Class... ..	889
◦ Problems with Maps V2 at Runtime .....	892
◦ Problems with Maps V2 Deployment .....	892
◦ Mapping Alternatives .....	893
◦ Getting Help .....	894
• <a href="#">Mapping with the Legacy MapView</a> .....	
◦ Prerequisites .....	895
◦ Terms, Not of Endearment .....	896
◦ Piling On .....	896
◦ The Key To It All .....	896
◦ The Bare Bones .....	898
◦ Exercising Your Control .....	900
◦ Layers Upon Layers .....	901
◦ My, Myself, and MyLocationOverlay .....	904
◦ Rugged Terrain .....	905
◦ Maps and Fragments .....	907
◦ Get to the Point .....	911
◦ Not-So-Tiny Bubbles .....	913
◦ Sign, Sign, Everywhere a Sign .....	924
◦ In A New York Minute. Or Hopefully a Bit Faster. ....	930
◦ A Little Touch of Noo Yawk .....	932

- [Custom Drawables](#)
  - **Prerequisites** ..... 941
  - AnimationDrawable ..... 942
  - StateListDrawable ..... 944
  - LayerDrawable ..... 946
  - TransitionDrawable ..... 947
  - LevelListDrawable ..... 948
  - **ScaleDrawable and ClipDrawable** ..... 949
  - InsetDrawable ..... 958
  - ShapeDrawable ..... 959
  - Composite Drawables ..... 969
  - XML Drawables and Eclipse ..... 973
  - A Stitch In Time Saves Nine ..... 973
- [Animators](#)
  - Prerequisites ..... 983
  - ViewPropertyAnimator ..... 983
  - The Foundation: Value and Object Animators ..... 988
  - Hardware Acceleration ..... 991
  - **The Three-Fragment Problem** ..... 992
- [Legacy Animations](#)
  - Prerequisites ..... 1003
  - **It's Not Just For Toons Anymore** ..... 1003
  - A Quirky Translation ..... 1004
  - Fading To Black. Or Some Other Color. .... 1008
  - When It's All Said And Done ..... 1010
  - **Loose Fill** ..... 1011
  - Hit The Accelerator ..... 1011
  - Animate. Set. Match. .... 1012
  - Active Animations ..... 1013
- [Crafting Your Own Views](#)
  - Prerequisites ..... 1015
  - Pick Your Poison ..... 1015
  - **Colors, Mixed How You Like Them** ..... 1017
- [Custom Dialogs and Preferences](#)
  - Prerequisites ..... 1027
  - **Your Dialog, Chocolate-Covered** ..... 1027
  - Preferring Your Own Preferences, Preferably ..... 1031
- [Progress Indicators](#)
  - Prerequisites ..... 1037
  - Progress Bars ..... 1037
  - ProgressBar and Threads ..... 1040



- **Tailoring Progress Bars** ..... 1043
- Progress Dialogs ..... 1051
- Title Bar and Action Bar Progress Indicators ..... 1053
- Action Bar Refresh-and-Progress Items ..... 1055
- Direct Progress Indication ..... 1058
- [Advanced Notifications](#)
  - Prerequisites ..... 1061
  - Custom Views: or How Those Progress Bars Work ..... 1061
  - Seeing It In Action ..... 1063
  - Life After Delete ..... 1068
  - The Mysterious Case of the Missing Number ..... 1069
- [More Fun with Pagers](#)
  - Prerequisites ..... 1071
  - **ViewPager with Action Bar Tabs** ..... 1071
- [Focus Management and Accessibility](#)
  - Prerequisites ..... 1077
  - Prepping for Testing ..... 1078
  - **Controlling the Focus** ..... 1078
  - Accessibility and Focus ..... 1087
  - Accessibility Beyond Focus ..... 1088
  - Accessibility Beyond Impairment ..... 1098
- [Home Screen App Widgets](#)
  - Prerequisites ..... 1101
  - East is East, and West is West... ..... 1102
  - The Big Picture for a Small App Widget ..... 1102
  - **Crafting App Widgets** ..... 1103
  - Another and Another ..... 1111
  - App Widgets: Their Life and Times ..... 1112
  - Controlling Your (App Widget's) Destiny ..... 1112
  - Change Your Look ..... 1113
  - One Size May Not Fit All ..... 1114
  - Lockscreen Widgets ..... 1120
  - Being a Good Host ..... 1126
- [Adapter-Based App Widgets](#)
  - Prerequisites ..... 1127
  - New Widgets for App Widgets ..... 1127
  - Preview Images ..... 1128
  - **Adapter-Based App Widgets** ..... 1130
- [Content Provider Theory](#)
  - Prerequisites ..... 1145
  - Using a Content Provider ..... 1145

- **Building Content Providers** ..... 1151
  - Issues with Content Providers ..... 1158
- [Content Provider Implementation Patterns](#)
  - Prerequisites ..... 1159
  - The Single-Table Database-Backed Content Provider ..... 1159
  - The Local-File Content Provider ..... 1167
  - The Stream Provider ..... 1171
- [The Loader Framework](#)
  - Prerequisites ..... 1175
  - Cursors: Issues with Management ..... 1176
  - Introducing the Loader Framework ..... 1176
  - Honeycomb... Or Not ..... 1178
  - **Using CursorLoader** ..... 1179
  - Using SQLiteCursorLoader ..... 1181
  - Inside SQLiteCursorLoader ..... 1182
  - What Else Is Missing? ..... 1186
  - Issues, Issues, Issues ..... 1186
  - Loaders Beyond Cursors ..... 1186
  - What Happens When...? ..... 1189
- [The ContactsContract Provider](#)
  - Prerequisites ..... 1193
  - Introducing You to Your Contacts ..... 1194
  - Pick a Peck of Pickled People ..... 1195
  - Spin Through Your Contacts ..... 1198
  - Makin' Contacts ..... 1207
- [The CalendarContract Provider](#)
  - Prerequisites ..... 1214
  - You Can't Be a Faker ..... 1214
  - Do You Have Room on Your Calendar? ..... 1214
  - Penciling In an Event ..... 1219
- [Encrypted Storage](#)
  - Prerequisites ..... 1222
  - Scenarios for Encryption ..... 1222
  - Obtaining SQLCipher ..... 1223
  - Employing SQLCipher ..... 1223
  - **SQLCipher Limitations** ..... 1226
  - Passwords and Sessions ..... 1226
  - **About Those Passphrases...** ..... 1227
  - **Encrypted Preferences** ..... 1232
  - IOCipher ..... 1234
- [Tutorial: Upgrading to SQLCipher](#)

- Prerequisites ..... 1235
- Step #1: Getting Your Starting Point ..... 1235
- Step #2: Adding SQLCipher for Android ..... 1248
- Step #3: Adding a New Launcher Activity ..... 1248
- Step #4: Collect Passphrase For New Encryption ..... 1250
- Step #5: Create or Encrypt the Database ..... 1255
- Step #6: Collect Passphrase For Decryption ..... 1260
- [Packaging and Distributing Data](#)
  - Prerequisites ..... 1263
  - Packing a Database To Go ..... 1263
- [Audio Playback](#)
  - Prerequisites ..... 1267
  - Get Your Media On ..... 1267
  - MediaPlayer for Audio ..... 1268
  - Other Ways to Make Noise ..... 1274
- [Audio Recording](#)
  - Prerequisites ..... 1277
  - Recording by Intent ..... 1277
  - Recording to Files ..... 1280
  - Recording to Streams ..... 1283
  - Raw Audio Input ..... 1286
  - Requesting the Microphone ..... 1286
- [Video Playback](#)
  - Prerequisites ..... 1289
  - Moving Pictures ..... 1289
- [Advanced Permissions](#)
  - Prerequisites ..... 1295
  - Securing Yourself ..... 1295
  - Signature Permissions ..... 1298
- [Tapjacking](#)
  - Prerequisites ..... 1301
  - What is Tapjacking? ..... 1301
  - Detecting Potential Tapjackers ..... 1306
  - Defending Against Tapjackers ..... 1309
  - Why Is This Being Discussed? ..... 1312
  - What Changed in 4.0.3? ..... 1312
- [Accessing Location-Based Services](#)
  - Prerequisites ..... 1313
  - Location Providers: They Know Where You're Hiding ..... 1314
  - Finding Yourself ..... 1314
  - On the Move ..... 1316

- Are We There Yet? Are We There Yet? Are We There Yet? ..... 1317
- **Testing... Testing...** ..... **1318**
- **Alternative Flavors of Updates** ..... **1319**
- [Working with the Clipboard](#)
  - Prerequisites ..... 1321
  - Using the Clipboard on Android 1.x/2.x ..... 1321
  - Advanced Clipboard on Android 3.x ..... 1325
- [Telephony](#)
  - Prerequisites ..... 1331
  - Report To The Manager ..... 1332
  - You Make the Call! ..... 1332
  - No, Really, You Make the Call! ..... 1335
- [Working With SMS](#)
  - Prerequisites ..... 1337
  - Sending Out an SOS, Give or Take a Letter ..... 1337
  - You Can't Get There From Here ..... 1344
- [Using the Camera](#)
  - Prerequisites ..... 1347
  - Letting the Camera App Do It ..... 1347
  - Scanning with ZXing ..... 1349
  - Directly Working with the Camera ..... 1351
  - Being Specific About Features ..... 1351
- [NFC](#)
  - Prerequisites ..... 1353
  - **What Is NFC?** ..... **1353**
  - To NDEF, Or Not to NDEF ..... 1355
  - NDEF Modalities ..... 1355
  - NDEF Structure and Android's Translation ..... 1356
  - The Reality of NDEF ..... 1357
  - Sources of Tags ..... 1359
  - Writing to a Tag ..... 1359
  - Responding to a Tag ..... 1367
  - Expected Pattern: Bootstrap ..... 1368
  - Mobile Devices are Mobile ..... 1368
  - Enabled and Disabled ..... 1369
  - Android Beam ..... 1369
  - Beaming Files ..... 1376
  - Another Sample: SecretAgentMan ..... 1377
  - Additional Resources ..... 1386
- [Device Administration](#)
  - Prerequisites ..... 1387

- Objectives and Scope ..... 1387
- Defining and Registering an Admin Component ..... 1388
- Going Into Lockdown ..... 1394
- Mandating Quality of Security ..... 1401
- Getting Along with Others ..... 1402
- [PowerManager and WakeLocks](#)
  - Prerequisites ..... 1403
  - Keeping the Screen On, UI-Style ..... 1403
  - The Role of the WakeLock ..... 1404
  - What WakefulIntentService Does ..... 1405
- [Push Notifications with GCM](#)
  - Prerequisites ..... 1407
  - The Precursor: C2DM ..... 1407
  - The Replacement: GCM ..... 1408
  - The Pieces of Push ..... 1408
  - A Simple Push ..... 1415
  - Message Options and Advanced Features ..... 1422
  - Re-Registration ..... 1424
  - Considering Encryption ..... 1424
  - Issues with GCM ..... 1425
- [Push Notifications with C2DM](#)
  - Prerequisites ..... 1429
  - Pieces of Push ..... 1430
  - Getting From Here to There ..... 1431
  - Permissions for Push ..... 1432
  - Registering an Interest ..... 1433
  - Push It Real Good ..... 1436
  - A Controlled Push ..... 1438
  - The Right Way to Push ..... 1440
- [Other System Settings and Services](#)
  - Prerequisites ..... 1441
  - Setting Expectations ..... 1441
  - Can You Hear Me Now? OK, How About Now? ..... 1446
  - The Rest of the Gang ..... 1449
- [Dealing with Different Hardware](#)
  - Prerequisites ..... 1451
  - Filtering Out Devices ..... 1451
  - Runtime Capability Detection ..... 1454
  - Dealing with Device Bugs ..... 1455
- [Responding to URLs](#)
  - Prerequisites ..... 1457

- **Manifest Modifications** ..... 1457
- Creating a Custom URL ..... 1459
- Reacting to the Link ..... 1459
- [Plugin Patterns](#)
  - **Plugins by Remote** ..... 1463
  - ContentProvider Plugins ..... 1473
- [PackageManager Tricks](#)
  - Prerequisites ..... 1483
  - Asking Around ..... 1483
  - Preferred Activities ..... 1487
  - Middle Management ..... 1492
- [Searching with SearchManager](#)
  - Prerequisites ..... 1495
  - Hunting Season ..... 1495
  - Search Yourself ..... 1497
  - Searching for Meaning In Randomness ..... 1504
  - May I Make a Suggestion? ..... 1505
  - **Putting Yourself (Almost) On Par with Google** ..... 1509
- [Handling System Events](#)
  - Prerequisites ..... 1515
  - I Sense a Connection Between Us... ..... 1515
  - Feeling Drained ..... 1517
- [Remote Services and the Binding Pattern](#)
  - Prerequisites ..... 1525
  - **The Binding Pattern** ..... 1526
  - When IPC Attacks! ..... 1532
  - Service From Afar ..... 1534
  - Servicing the Service ..... 1539
  - Thinking About Security ..... 1545
  - The “Everlasting Service” Anti-Pattern ..... 1545
- [Advanced Manifest Tips](#)
  - Prerequisites ..... 1547
  - Just Looking For Some Elbow Room ..... 1547
  - Using an Alias ..... 1556
- [Miscellaneous Integration Tips](#)
  - Prerequisites ..... 1559
  - Take the Shortcut ..... 1559
  - Homing Beacons for Intents ..... 1566
  - ShareActionProvider ..... 1566
- [Reusable Components](#)
  - Prerequisites ..... 1571

◦ Pick Up a JAR .....	1571
◦ A Private Library .....	1578
• <a href="#">The Role of Scripting Languages</a>	
◦ Prerequisites .....	1581
◦ All Grown Up .....	1581
◦ Following the Script .....	1582
◦ Going Off-Script .....	1583
• <a href="#">The Scripting Layer for Android</a>	
◦ Prerequisites .....	1587
◦ The Role of SL4A .....	1587
◦ Getting Started with SL4A .....	1588
◦ Writing SL4A Scripts .....	1596
◦ Running SL4A Scripts .....	1601
◦ Potential Issues .....	1602
• <a href="#">JVM Scripting Languages</a>	
◦ Prerequisites .....	1605
◦ Languages on Languages .....	1605
◦ <i>A Brief History of JVM Scripting</i> .....	<b>1606</b>
◦ Limitations .....	1607
◦ SL4A and JVM Languages .....	1608
◦ <i>Embedding JVM Languages</i> .....	<b>1608</b>
◦ Other JVM Scripting Languages .....	1622
• <a href="#">JUnit and Android</a>	
◦ Prerequisites .....	1625
◦ You Get What They Give You .....	1625
◦ <i>Your Test Cases</i> .....	<b>1628</b>
◦ Your Test Suite .....	1633
◦ Running Your Tests .....	1634
• <a href="#">MonkeyRunner and the Test Monkey</a>	
◦ Prerequisites .....	1637
◦ MonkeyRunner .....	1637
◦ Monkeying Around .....	1639
• <a href="#">Advanced Emulator Capabilities</a>	
◦ Prerequisites .....	1641
◦ x86 Images .....	1641
◦ Hardware Graphics Acceleration .....	1644
◦ Keyboard Behavior .....	1646
◦ Navigation Button Behavior .....	1647
◦ Headless Operation .....	1647
• <a href="#">Using Lint</a>	
◦ Prerequisites .....	1649

◦ What It Is .....	1649
◦ When It Runs .....	1650
◦ What to Fix .....	1652
◦ What to Configure .....	1652
• <a href="#">Using Hierarchy View</a>	
◦ Prerequisites .....	1657
◦ Launching Hierarchy View .....	1657
◦ Viewing the View Hierarchy .....	1658
◦ ViewServer .....	1661
• <a href="#">Using DDMS</a>	
◦ Prerequisites .....	1663
◦ Starting DDMS .....	1663
◦ File Push and Pull .....	1664
◦ Screenshots .....	1665
◦ Location Updates .....	1665
◦ <b>Placing Calls and Messages</b> .....	<b>1666</b>
• <a href="#">Signing Your App</a>	
◦ Prerequisites .....	1669
◦ Role of Code Signing .....	1669
◦ What Happens In Debug Mode .....	1670
◦ Creating a Production Signing Key .....	1670
• <a href="#">Distribution</a>	
◦ Prerequisites .....	1677
◦ <b>Get Ready To Go To Market</b> .....	<b>1677</b>
• <a href="#">Issues with Speed</a>	
◦ Prerequisites .....	1683
◦ Getting Things Done .....	1683
◦ Your UI Seems... Janky .....	1684
◦ Not Far Enough in the Background .....	1684
◦ Playing with Speed .....	1685
• <a href="#">Finding CPU Bottlenecks</a>	
◦ Prerequisites .....	1687
◦ Traceview .....	1688
◦ Other General CPU Measurement Techniques .....	1697
◦ <b>UI “Jank” Measurement</b> .....	<b>1699</b>
• <a href="#">Focus On: NDK</a>	
◦ Prerequisites .....	1715
◦ The Role of the NDK .....	1716
◦ NDK Installation and Project Setup .....	1719
◦ Writing Your Makefile(s) .....	1723
◦ Building Your Library .....	1725



- Using Your Library Via JNI ..... 1725
- Building and Deploying Your Project ..... 1731
- [Improving CPU Performance in Java](#)
  - Prerequisites ..... 1733
  - Reduce CPU Utilization ..... 1733
  - Reduce Time on the Main Application Thread ..... 1738
  - Improve Throughput and Responsiveness ..... 1746
- [Finding and Eliminating Jank](#)
  - *Prerequisites* ..... 1749
  - *The Case: ThreePaneDemoBC* ..... 1749
  - *Are We Janky?* ..... 1750
  - *Finding the Source of the Jank* ..... 1750
  - *Where Things Went Wrong* ..... 1760
  - *Removing the Jank* ..... 1761
- [Issues with Bandwidth](#)
  - Prerequisites ..... 1763
  - You're Using Too Much of the Slow Stuff ..... 1764
  - You're Using Too Much of the Expensive Stuff ..... 1764
  - *You're Using Too Much of Somebody Else's Stuff* ..... 1765
  - You're Using Too Much... And There Is None ..... 1766
- [Focus On: TrafficStats](#)
  - Prerequisites ..... 1767
  - TrafficStats Basics ..... 1767
  - Example: TrafficMonitor ..... 1769
  - Other Ways to Employ TrafficStats ..... 1777
- [Measuring Bandwidth Consumption](#)
  - Prerequisites ..... 1779
  - On-Device Measurement ..... 1779
  - Off-Device Measurement ..... 1781
  - Tactical Measurement in DDMS ..... 1783
- [Being Smarter About Bandwidth](#)
  - Prerequisites ..... 1787
  - Bandwidth Savings ..... 1787
  - Bandwidth Shaping ..... 1793
  - Avoiding Metered Connections ..... 1796
- [Issues with Memory](#)
  - Prerequisites ..... 1799
  - You Are in a Heap of Trouble ..... 1799
  - Warning: Contains Graphic Images ..... 1800
  - In Too Deep (on the Stack) ..... 1801
- [Finding Memory Leaks with MAT](#)

◦ Prerequisites .....	1803
◦ Setting Up MAT .....	1803
◦ Getting Heap Dumps .....	1804
◦ Basic MAT Operation .....	1810
◦ Some Leaks and Their MAT Analysis .....	1816
• <a href="#">Issues with Battery Life</a>	
◦ Prerequisites .....	1825
◦ You're Getting Blamed .....	1826
◦ Stretching Out the Last mWh .....	1827
• <a href="#">Focus On: MDP and Trepn</a>	
◦ Prerequisites .....	1829
◦ What Are You Talking About? .....	1829
◦ Running Trepn Tests .....	1831
◦ Recording Application States .....	1832
◦ Examining Trepn Results .....	1833
• <a href="#">Other Power Measurement Options</a>	
◦ Prerequisites .....	1837
◦ PowerTutor .....	1837
◦ Battery Screen in Settings Application .....	1841
◦ BatteryInfo Dump .....	1843
• <a href="#">The Role of Alternative Environments</a>	
◦ Prerequisites .....	1847
◦ In the Beginning, There Was Java... ..	1848
◦ ... And It Was OK .....	1848
◦ Bucking the Trend .....	1849
◦ Support, Structure .....	1849
◦ Caveat Developer .....	1850
• <a href="#">HTML5</a>	
◦ Prerequisites .....	1851
◦ Offline Applications .....	1851
◦ Web Storage .....	1858
◦ Going To Production .....	1861
◦ Issues You May Encounter .....	1862
◦ HTML5: The Baseline .....	1865
• <a href="#">PhoneGap</a>	
◦ Prerequisites .....	1867
◦ What Is PhoneGap? .....	1867
◦ Using PhoneGap .....	1870
◦ PhoneGap and the Checklist Sample .....	1875
◦ Issues You May Encounter .....	1880
◦ For More Information .....	1883

- [Other Alternative Environments](#)
  - Prerequisites ..... 1885
  - Rhodes ..... 1885
  - Flash, Flex, and AIR ..... 1886
  - JRuby and Ruboto ..... 1886
  - Mono for Android ..... 1887
  - App Inventor ..... 1887
  - Titanium Mobile ..... 1889
  - Other JVM Compiled Languages ..... 1890
- [Anti-Patterns](#)
  - Prerequisites ..... 1891
  - Leak Threads... Or Things Attached to Threads ..... 1891
  - Use Large Heap Unnecessarily ..... 1893
  - Misuse the MENU Button ..... 1895
  - Interfere with Navigation ..... 1896
  - Use android:sharedUserId ..... 1898
  - Implement a “Quit” Button ..... 1899
  - Terminate Your Process ..... 1901
  - **Try to Hide from the User** ..... **1902**
  - Use Multiple Processes ..... 1903
  - Do Not Hog System Resources ..... 1905
- [Widget Catalog: AdapterViewFlipper](#)
  - Key Usage Tips ..... 1907
  - A Sample Usage ..... 1908
  - Visual Representation ..... 1908
- [Widget Catalog: DatePicker](#)
  - Key Usage Tips ..... 1909
  - A Sample Usage ..... 1909
  - Visual Representation ..... 1911
- [Widget Catalog: ExpandableListView](#)
  - **Key Usage Tips** ..... **1915**
  - A Sample Usage ..... 1916
  - Visual Representation ..... 1922
- [Widget Catalog: SeekBar](#)
  - Key Usage Tips ..... 1925
  - A Sample Usage ..... 1925
  - Visual Representation ..... 1927
- [Widget Catalog: SlidingDrawer](#)
  - Key Usage Tips ..... 1929
  - A Sample Usage ..... 1930
  - Visual Representation ..... 1931

- [Widget Catalog: StackView](#)
  - Key Usage Tips ..... 1933
  - A Sample Usage ..... 1934
  - Visual Representation ..... 1935
- [Widget Catalog: TabHost and TabWidget](#)
  - Deprecation Notes ..... 1937
  - Key Usage Tips ..... 1937
  - A Sample Usage ..... 1938
  - Visual Representation ..... 1940
- [Widget Catalog: TimePicker](#)
  - Key Usage Tips ..... 1943
  - A Sample Usage ..... 1943
  - Visual Representation ..... 1945
- [Widget Catalog: ViewFlipper](#)
  - **Key Usage Tips** ..... **1947**
  - A Sample Usage ..... 1948
  - Visual Representation ..... 1949
- [Device Catalog: Google TV](#)
  - Prerequisites ..... 1951
  - What Features and Configurations Does It Use? ..... 1952
  - What Is Really Different? ..... 1953
  - Getting Your Development Environment Established ..... 1957
  - How Does Distribution Work? ..... 1960
  - Getting Help ..... 1961
- [Device Catalog: Kindle Fire](#)
  - Prerequisites ..... 1963
  - What Features and Configurations Does It Use? ..... 1963
  - What Is Really Different? ..... 1965
  - Getting Your Development Environment Established ..... 1970
  - How Does Distribution Work? ..... 1974
- [Device Catalog: Barnes & Noble NOOK Tablet](#)
  - Prerequisites ..... 1977
  - What Features and Configurations Does It Use? ..... 1978
  - What Is Really Different? ..... 1978
  - Getting Your Development Environment Established ..... 1980
  - How Does Distribution Work? ..... 1982
- [Device Catalog: RIM Blackberry Playbook](#)
  - What Features and Configurations Does It Use? ..... 1983
  - What Is Really Different? ..... 1984
  - Getting Your Development Environment Established ..... 1985
  - How Does Distribution Work? ..... 1987

- [Accessory Catalog: SONY SmartWatch](#)
  - Prerequisites ..... 1989
  - What Can This Thing Really Do? ..... 1989
  - What Are You Really Writing? ..... 1990
  - Getting Your Development Environment Established ..... 1991
  - How Does Distribution Work? ..... 1992
  - Example: WatchAuth ..... 1992
  - Getting Help ..... 2006

# Preface

---

## Welcome to the Book!

Thanks!

Thanks for your interest in developing applications for Android! Android has grown from nothing to arguably the world's most popular smartphone OS in a few short years. Whether you are developing applications for the public, for your business or organization, or are just experimenting on your own, I think you will find Android to be an exciting and challenging area for exploration.

And, most of all, thanks for your interest in this book! I sincerely hope you find it useful and at least occasionally entertaining.

## The Book's Structure

Once upon a time, CommonsWare published a few books on Android development. What you are reading represents the merger of those separate titles into a single omnibus title.

To make the equivalent of 2,000+ pages of material manageable, the chapters are divided into the *core* chapters and a series of *trails*.

The core chapters represent many key concepts that Android developers need to understand in order to build an app. While an occasional “nice to have” topic will drift into the core — to help illustrate a point, for example — the core chapters generally are fairly essential.

## PREFACE

---

The core chapters are designed to be read in sequence and will interleave both traditional technical book prose with tutorial chapters (in the style of CommonsWare's former *Android Programming Tutorials*), to give you hands-on experience with the concepts being discussed. Most of the tutorials can be skipped, though the first two — covering setting up your SDK environment and creating a project — everybody should read.

The bulk of the chapters are divided into trails, covering some particular general topic, from data storage to advanced UI effects to performance measurement and tuning. Each trail will have several chapters. However, those chapters, and the trails themselves, are not necessarily designed to be read in any order. Each chapter in the trails will point out prerequisite chapters or concepts that you will want to have covered in advance. Hence, these chapters are mostly reference material, for when you specifically want to learn something about a specific topic.

The core chapters will link to chapters in the trails, to show you where you can find material related to the chapter you just read. So between the book's table of contents, this preface, the search tool in your digital book reader, and the cross-chapter links, you should have plenty of ways of finding the material you want to read.

You are welcome to read the entire book front-to-back if you wish. The trails will appear after the core chapters. Those trails will be in a reasonably logical order, though you may have to hop around a bit to cover all of the prerequisites.

## The Trails

Here is a list of all of the trails and the chapters that pertain to those trails, in order of appearance (except for those appearing in the list multiple times, where they span major categories):

### Advanced UI

- [Introducing GridLayout](#)
  - [Dialogs and DialogFragments](#)
  - [Advanced ListViews](#)
  - [Action Bar Navigation](#)
  - [Action Modes and Context Menus](#)
  - [Advanced Uses of WebView](#)
  - [The Input Method Framework](#)
-

- [Fonts](#)
- [Rich Text](#)
- [Mapping with Maps V2](#)
- [Mapping with the Legacy MapView](#)
- [Custom Drawables](#)
- [Animators](#)
- [Legacy Animations](#)
- [Crafting Your Own Views](#)
- [Custom Dialogs and Preferences](#)
- [Progress Indicators](#)
- [Advanced Notifications](#)
- [More Fun with Pagers](#)
- [Focus Management and Accessibility](#)

### Home Screen Effects

- [Home Screen App Widgets](#)
- [Adapter-Based App Widgets](#)

### Data Storage and Retrieval

- [Content Provider Theory](#)
- [Content Provider Implementation Patterns](#)
- [The Loader Framework](#)
- [The ContactsContract Provider](#)
- [The CalendarContract Provider](#)
- [Encrypted Storage](#)
- [Tutorial: Upgrading to SQLCipher](#)
- [Packaging and Distributing Data](#)

### Media

- [Audio Playback](#)
- [Audio Recording](#)
- [Video Playback](#)

### Security

- [Encrypted Storage](#)
- [Advanced Permissions](#)



- [Tapjacking](#)

## Hardware and System Services

- [Accessing Location-Based Services](#)
- [Working with the Clipboard](#)
- [Telephony](#)
- [Working With SMS](#)
- [Camera](#)
- [NFC](#)
- [Device Administration](#)
- [PowerManager and WakeLocks](#)
- [Push Notifications with GCM](#)
- [Push Notifications with C2DM](#)
- [Other System Settings and Services](#)
- [Dealing with Different Hardware](#)

## Integration and Introspection

- [Responding to URLs](#)
- [Plugin Patterns](#)
- [PackageManager Tricks](#)
- [Searching with SearchManager](#)
- [System Events](#)
- [Remote Services and the Binding Pattern](#)
- [Advanced Manifest Tips](#)
- [Miscellaneous Integration Tips](#)
- [Reusable Components](#)

## Scripting Languages

- [The Role of Scripting Languages](#)
- [The Scripting Layer for Android](#)
- [JVM Scripting Languages](#)

## Testing

- [JUnit and Android](#)
- [MonkeyRunner and the Test Monkey](#)

## Tools

- [Advanced Emulator Capabilities](#)
- [Using Lint](#)
- [Using Hierarchy View](#)
- [Using DDMS](#)
- [Finding CPU Bottlenecks](#)
- [Finding Memory Leaks with MAT](#)

## Production

- [Signing Your App](#)
- [Distribution](#)

## Tuning Android Applications

- [Issues with Speed](#)
- [Finding CPU Bottlenecks](#)
- [NDK](#)
- [Improving CPU Performance in Java](#)
- [Finding and Eliminating Jank](#)
- [Issues with Bandwidth](#)
- [Focus On: TrafficStats](#)
- [Measuring Bandwidth Consumption](#)
- [Being Smarter About Bandwidth](#)
- [Issues with Memory](#)
- [Finding Memory Leaks with MAT](#)
- [Issues with Battery Life](#)
- [Focus On: MDP and Trepn](#)
- [Other Power Measurement Options](#)

## Alternatives for App Development

- [The Role of Alternative Environments](#)
- [HTML5](#)
- [PhoneGap](#)
- [Other Alternative Environments](#)

## Miscellaneous Topics

- [Anti-Patterns](#)

## Widget Catalog

- [AdapterViewFlipper](#)
- [DatePicker](#)
- [ExpandableListView](#)
- [SeekBar](#)
- [SlidingDrawer](#)
- [StackView](#)
- [TabHost](#)
- [TimePicker](#)
- [ViewFlipper](#)

## Device Catalog

- [Google TV](#)
- [Kindle Fire](#)
- [Barnes & Noble NOOK Tablet](#)
- [RIM Blackberry Playbook](#)

## Accessory Catalog

- [SONY SmartWatch](#)

## About the Updates

This book is updated frequently, typically once per month.

Each release has notations to show what is new or changed compared with the immediately preceding release:

- The Table of Contents shows sections with changes in bold-italic font
- Those sections have changebars on the right to denote specific paragraphs that are new or modified

## Warescription

You (hopefully) are reading this digital book by means of a Warescription.

The Warescription entitles you, for the duration of your subscription, to digital editions of this book and its updates, in PDF, EPUB, and Kindle (MOBI/KF8) formats. You also have access to other titles that CommonsWare may publish during that subscription period.

Each subscriber gets personalized editions of all editions of each title. That way, your books are never out of date for long, and you can take advantage of new material as it is made available instead of having to wait for a whole new print edition. For example, when new releases of the Android SDK are made available, this book will be quickly updated to be accurate with changes in the APIs.

Subscribers also have access to “office hours” — online chats to help you get answers to your Android application development questions. You will find a calendar for these on your Warescription page.

You can find out when new releases of this book are available via:

1. The [commonsguy](#) Twitter feed
2. The [CommonsBlog](#)
3. The Warescription newsletter, which you can subscribe to off of your [Warescription](#) page

## Getting Help

If you have questions about the book examples, visit [StackOverflow](#) and ask a question, tagged with *android* and *commonsware*.

If you have general Android developer questions, visit StackOverflow and ask a question, tagged with *android* (and any other relevant tags, such as *java*).

## Book Bug Bounty

Find a problem in one of our books? Let us know!

## PREFACE

---

Be the first to report a unique concrete problem in the current digital edition, and we'll give you a coupon for a six-month Warescription as a bounty for helping us deliver a better product. You can use that coupon to get a new Warescription, renew an existing Warescription, or give the coupon to a friend, colleague, or some random person you meet on the subway.

By “concrete” problem, we mean things like:

1. Typographical errors
2. Sample applications that do not work as advertised, in the environment described in the book
3. Factual errors that cannot be open to interpretation

By “unique”, we mean ones not yet reported. Be sure to check [the book's errata page](#), though, to see if your issue has already been reported. One coupon is given per email containing valid bug reports.

We appreciate hearing about “softer” issues as well, such as:

1. Places where you think we are in error, but where we feel our interpretation is reasonable
2. Places where you think we could add sample applications, or expand upon the existing material
3. Samples that do not work due to “shifting sands” of the underlying environment (e.g., changed APIs with new releases of an SDK)

However, those “softer” issues do not qualify for the formal bounty program.

Questions about the bug bounty, or problems you wish to report for bounty consideration, should be sent to [bounty@commonsware.com](mailto:bounty@commonsware.com).

## Source Code And Its License

The source code samples shown in this book are available for download from the [book's GitHub repository](#). All of the Android projects are licensed under the [Apache 2.0 License](#), in case you have the desire to reuse any of it.

If you wish to use the source code from the CommonsWare Web site, bear in mind that the projects are set up to be built by Eclipse. Many are also set up to be built by Ant from the command line. However, for command-line builds, you will need to

update the build files to match your local environment. To do this, delete `build.xml` in your project directory, then run `android update project -p .` from that same directory. See [the GitHub repo home page](#) for more details.

Copying source code directly from the book, in the PDF editions, works best with Adobe Reader, though it may also work with other PDF viewers. Some PDF viewers, for reasons that remain unclear, foul up copying the source code to the clipboard when it is selected.

## Creative Commons and the Four-to-Free (42F) Guarantee

Each CommonsWare book edition will be available for use under the [Creative Commons Attribution-Noncommercial-ShareAlike 3.0](#) license as of the fourth anniversary of its publication date, or when 4,000 copies of the edition have been sold, whichever comes first. That means that, once four years have elapsed (perhaps sooner!), you can use this prose for non-commercial purposes. That is our Four-to-Free Guarantee to our readers and the broader community. For the purposes of this guarantee, new Warescriptions and renewals will be counted as sales of this edition, starting from the time the edition is published.

This edition of this book will be available under the aforementioned Creative Commons license on *1 January 2017*. Of course, watch the CommonsWare Web site, as this edition might be relicensed sooner based on sales.

For more details on the Creative Commons Attribution-Noncommercial-ShareAlike 3.0 license, visit the Creative Commons Web site.

Note that future editions of this book will become free on later dates, each four years from the publication of that edition or based on sales of that specific edition. Releasing one edition under the Creative Commons license does not automatically release *all* editions under that license.

## Acknowledgments

I would like to thank the Android team, not only for putting out a good product, but for invaluable assistance on the Android Google Groups and StackOverflow.

## PREFACE

---

I would also like to thank the thousands of readers of past editions of this book, for their feedback, bug reports, and overall support.

Of course, thanks are also out to the overall Android ecosystem, particularly those developers contributing their skills to publish libraries, write blog posts, answer support questions, and otherwise contribute to the strength of Android.

Portions of this book are reproduced from work created and shared by the Android Open Source Project and used according to terms described in the Creative Commons 2.5 Attribution License.

# Key Android Concepts

---

No doubt, you are in a hurry to get started with Android application development. After all, you are reading this book, aimed at busy coders.

However, before we dive into getting tools set up and starting in on actual programming, it is important that we “get on the same page” with respect to several high-level Android concepts. This will simplify further discussions later in the book.

## Android Applications

This book is focused on writing Android applications. An application is something that a user might install from the Play Store or otherwise download to their device. That application should have some user interface, and it might have other code designed to work in the background (multi-tasking).

This book is not focused on modifications to the Android firmware, such as writing device drivers. For that, you will need to seek other resources.

This book assumes that you have some hands-on experience with Android devices, and therefore you are familiar with buttons like HOME and BACK, the built-in Settings application, the concept of a home screen and launcher, and so forth. If you have never used an Android device, you are strongly encouraged to get one (e.g., a used one on eBay, Craigslist, etc.) and spend some time with it before starting in on learning Android application development.



### Programming Language

The vast majority of Android applications are written exclusively in Java. Hence, that is what this book will spend most of its time on and will demonstrate with a seemingly infinite number of examples.

However, there are other options:

- You can write parts of the app in C/C++, for performance gains, porting over existing code bases, etc.
- You can write an entire app in C/C++, mostly for games using OpenGL for 3D animations
- You can write the guts of an app in HTML, CSS, and JavaScript, using tools to package that material into an Android application that can be distributed through the Play Store and similar venues
- And so on

Coverage of these non-Java alternatives will be found in the trails of this book, as the bulk of this book is focused on Java.

The author assumes that you know Java at this point. If you do not, you will need to learn Java before you go much further. You do not need to know *everything* about Java, as Java is vast. Rather, focus on:

- [Language fundamentals](#) (flow control, etc.)
- [Classes and objects](#)
- [Methods](#) and [data members](#)
- [Public, private, and protected](#)
- [Static and instance scope](#)
- [Exceptions](#)
- [Threads](#) and [concurrency control](#)
- [Collections](#)
- [Generics](#)
- [File I/O](#)
- [Reflection](#)
- [Interfaces](#)

The links are to Wikibooks material on those topics, though there are countless other Java resources for you to consider.

### Components

When you first learned Java — whether that was yesterday or back when dinosaurs roamed the Earth — you probably started off with something like this:

```
class SillyApp {  
    public static void main(String[] args) {  
        System.out.println("Hello World!");  
    }  
}
```

In other words, the entry point into your application was a `public static void` method named `main()` that took a `String` array of arguments. From there, you were responsible for doing whatever was necessary.

However, there are other patterns used elsewhere in Java. For example, you do not usually write a `main()` method when writing a Java servlet. Instead, you would extend a particular class supplied by a framework (e.g., `HttpServlet`) to create a component, then wrote some metadata that enumerated your components and told the framework when and how to use them (e.g., `WEB.XML`).

Android apps are closer in spirit to the servlet approach. You will not write a `public static void main()` method. Instead, you will create subclasses of some Android-supplied base classes that define various application components. In addition, you will create some metadata that tells Android about those subclasses.

There are four types of components, all of which will be covered extensively in this book:

### Activities

The building block of the user interface is the *activity*. You can think of an activity as being the Android analogue for the window or dialog in a desktop application, or the page in a classic Web app.

Normally, an activity will take up most of the screen, leaving space for some “chrome” bits like the clock, signal strength indicators, and so forth.

## KEY ANDROID CONCEPTS

---

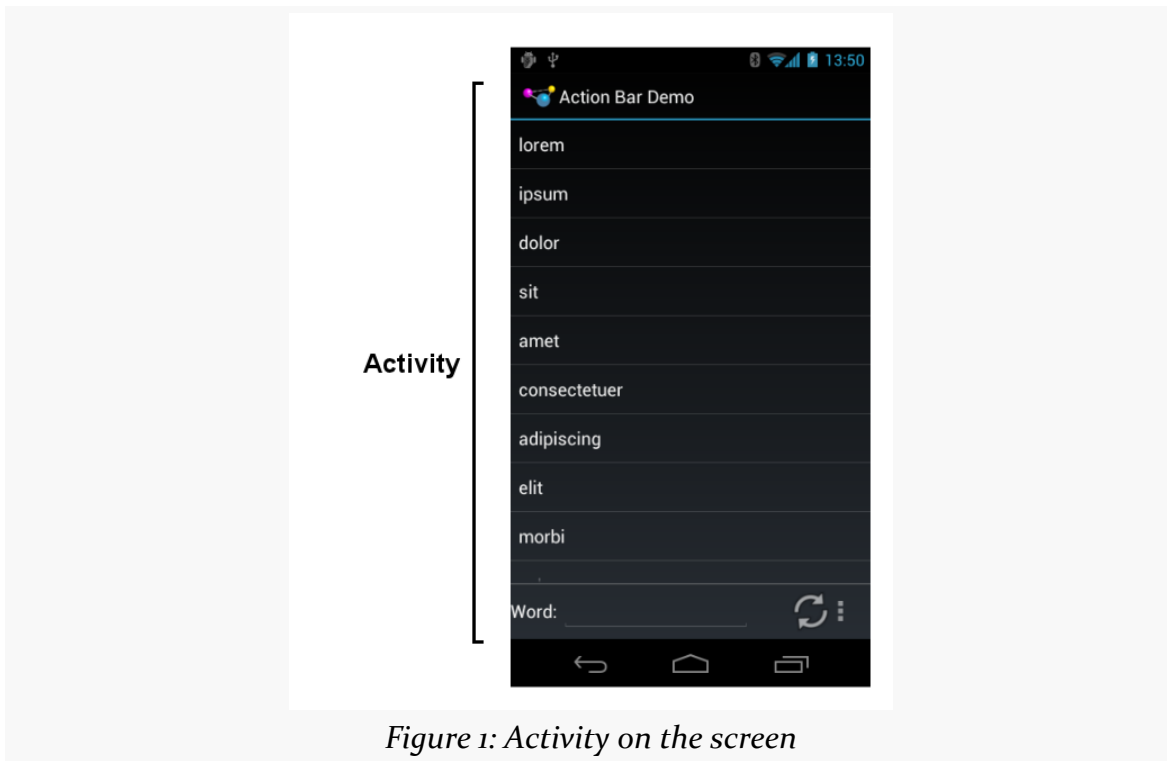


Figure 1: Activity on the screen

### Services

Activities are short-lived and can be shut down at any time, such as when the user presses the BACK button. *Services*, on the other hand, are designed to keep running, if needed, independent of any activity, for a short period of time. You might use a service for checking for updates to an RSS feed, or to play back music even if the controlling activity is no longer operating. You will also use services for scheduled tasks (akin to Linux or OS X “cron jobs”) and for exposing custom APIs to other applications on the device, though the latter is a relatively advanced capability.

### Content Providers

*Content providers* provide a level of abstraction for any data stored on the device that is accessible by multiple applications. The Android development model encourages you to make your own data available to other applications, as well as your own — building a content provider lets you do that, while maintaining a degree of control over how your data gets accessed.

### Broadcast Receivers

The system, or applications, will send out *broadcasts* from time to time, for everything from the battery getting low, to when the screen turns off, to when connectivity changes from WiFi to mobile data. A broadcast receiver can arrange to listen for these broadcasts and respond accordingly.

### Widgets, Containers, Resources, and Fragments

Most of the focus on Android application development is on the UI layer and activities. Most Android activities use what is known as “the widget framework” for rendering their user interface, though you are welcome to use the 2D (Canvas) and 3D (OpenGL) APIs as well for more specialized GUIs.

In Android terms, a *widget* is the “micro” unit of user interface. Fields, buttons, labels, lists, and so on are all widgets. Your activity’s UI, therefore, is made up of one or more of these widgets. For example, here we see label (TextView), field (EditText), and push-button (Button) widgets:

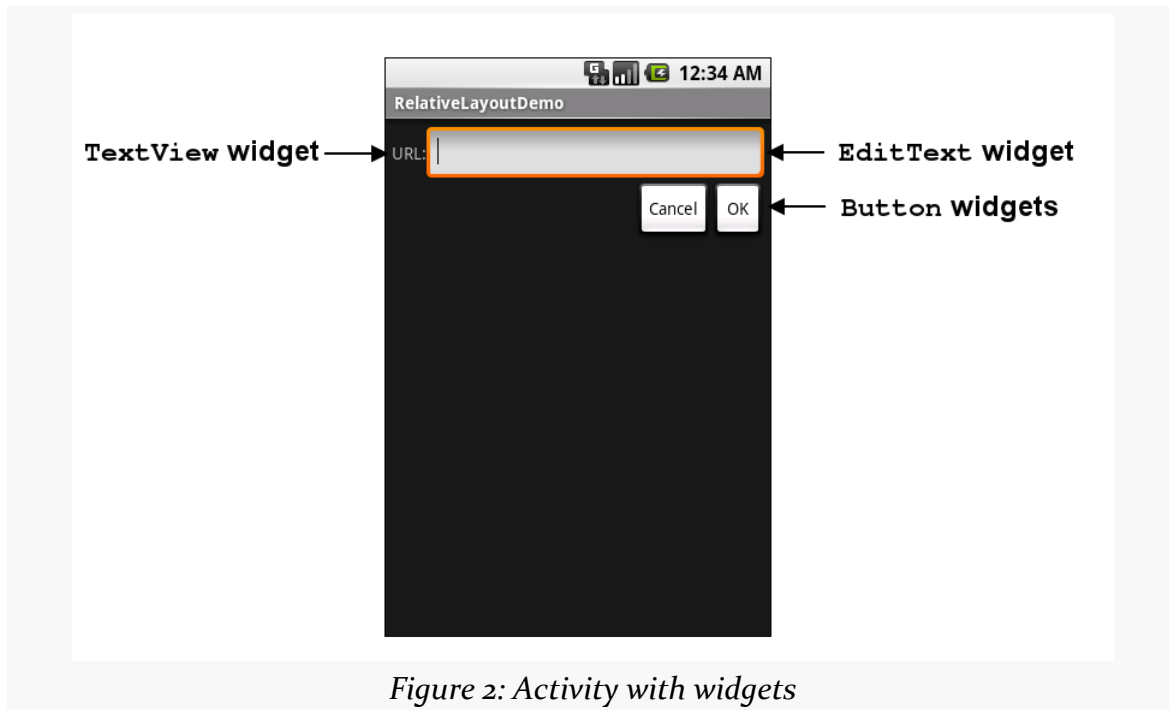


Figure 2: Activity with widgets

If you have more than one widget — which is fairly typical — you will need to tell Android how those widgets are organized on the screen. To do that, you will use

## KEY ANDROID CONCEPTS

---

various container classes referred to as *layout managers*. These will let you put things in rows, columns, or more complex arrangements as needed.

To describe how the containers and widgets are connected, you will typically create a *layout resource file*. *Resources* in Android refer to things like images, strings, and other material that your application uses but is not in the form of some programming language source code. UI layouts are another type of resource. You will create these layouts either using a structured tool, such as Eclipse's drag-and-drop GUI builder, or by hand in XML form.

Sometimes, your UI will work across all sorts of devices: phones, tablets, televisions, etc. Sometimes, your UI will need to be tailored for different environments. You will be able to put resources into *resource sets* that indicate under what circumstances those resources can be used (e.g., use these for normal-sized screens, but use those for larger screens).

Sometimes, supporting larger screens means you will want to “snap together” parts of your smaller-screen UI. For example, Gmail on a tablet will show your list of labels, the list of conversations in a selected label, and the list of messages in a selected conversation, all in one activity. However, Gmail on a phone cannot do that, as there is not enough screen space, so it shows each of those (labels, conversations, messages) in separate activities. Android supplies a construct called the *fragment* to help make it easier for you to implement these sorts of effects.

We will be examining all of these concepts, in much greater detail, as we get deeper into the book.

### **Apps and Packages**

Given a bucket of source code and a basket of resources, the Android build tools will give you an application as a result. The application comes in the form of an *APK file*. It is that APK file that you will upload to the Play Store or distribute by other means.

Each Android application has a package name. A package name must fulfill three requirements:

1. It must be a valid Java package name, as some Java source code will be generated by the Android build tools in this package.
2. No two applications can exist on a device at the same time with the same package.

3. No two applications can be uploaded to the Play Store having the same package.

When you create your Android project — the repository of that source code and those resources — you will declare what package name is to be used for your app. Typically, you will pick a package name following the Java package name “reverse domain name” convention (e.g., `com.commonsware.android.foo`). That way, the domain name system ensures that your package name prefix (`com.commonsware`) is unique, and it is up to you to ensure that the rest of the package name distinguishes one of your apps from any other.

## Android Devices

There are well in excess of 100 million Android devices in use today, representing hundreds of different models from dozens of different manufacturers. Android itself has evolved since Android 1.0 in 2008. Between different device types and different Android versions, many a media pundit has lobbed the term “fragmentation” at Android, suggesting that creating apps that run on all these different environments is impossible.

In reality, it is not that bad. Some apps will have substantial trouble, but most apps will work just fine if you follow the guidance presented in this book and in other resources.

## Types

Android devices come in all shapes, sizes, and colors. However, there are three dominant “form factors”:

- the phone
- the tablet
- the television (TV)

You will often hear developers and pundits refer to these form factors, and this book will do so from time to time as well. However, it is important that you understand that Android has no built-in concept of a device being a “phone” or a “tablet” or a “TV”. Rather, Android distinguishes devices based on capabilities and features. So, you will not see an `isPhone()` method anywhere, though you can ask Android:

- what is the screen size?

## KEY ANDROID CONCEPTS

---

- does the device have telephony capability?
- etc.

Similarly, as you build your applications, rather than thinking of those three form factors, focus on what capabilities and features you need. Not only will this help you line up better with how Android wants you to build your apps, but it will make it easier for you to adapt to other form factors that will come about such as:

- watches and other types of wearable devices
- airplane seat-back entertainment centers
- in-car navigation and entertainment devices
- and so on

### The Emulator

While there are hundreds of millions of Android devices representing hundreds of models, you probably do not have one of each model. You may only have a single piece of Android hardware. And if you do not even have that, you most certainly will want to acquire one before trying to publish an Android app.

To help fill in the gaps between the devices you have and the devices that are possible, the Android developer tools ship an *emulator*. The emulator behaves like a piece of Android hardware, but it is a program you run on your development machine. You can use this emulator to emulate many different devices, with different screen sizes and Android OS versions, by creating one or more Android virtual devices, or *AVDs*.

In [an upcoming chapter](#), we will discuss how you install the Android developer tools and how you will be able to [create these AVDs and run the emulator](#).

### OS Versions and API Levels

Android has come a long way since the early beta releases from late 2007. Each new Android OS version adds more capabilities to the platform and more things that developers can do to exploit those capabilities.

Moreover, the core Android development team tries very hard to ensure forwards and backwards compatibility. An app you write today should work unchanged on future versions of Android (forwards compatibility), albeit perhaps missing some features or working in some sort of “compatibility mode”. And there are well-trod

## KEY ANDROID CONCEPTS

---

paths for how to create apps that will work both on the latest and on previous versions of Android (backwards compatibility).

To help us keep track of all the different OS versions that matter to us as developers, Android has *API levels*. A new API level is defined when an Android version ships that contains changes that affect developers. When you create an emulator AVD to test your app, you will indicate what API level that emulator should emulate. When you distribute your app, you will indicate the oldest API level your app supports, so the app is not installed on older devices.

At the time of this writing, the API levels of significance to most Android developers are:

- API Level 3 (Android 1.5)
- API Level 4 (Android 1.6)
- API Level 7 (Android 2.1)
- API Level 8 (Android 2.2)
- API Level 10 (Android 2.3.3)
- API Level 12 (Android 3.1)
- API Level 13 (Android 3.2)
- API Level 15 (Android 4.0.3)
- API Level 16 (Android 4.1)
- API Level 17 (Android 4.2)

### Dalvik

You probably are thinking that Dalvik is a village in Iceland. That, however, is [Dalvík](#).

In terms of Android, Dalvik is a virtual machine (VM). Virtual machines are used by many programming languages, such as Java, Perl, and Smalltalk. The Dalvik VM is designed to work much like a Java VM, but optimized for embedded Linux environments.

So, what really goes on when somebody writes an Android application is:

1. Developers write Java-syntax source code, leveraging class libraries published by the Android project and third parties.
2. Developers compile the source code into Java VM bytecode, using the `javac` compiler that comes with the Java SDK.



## KEY ANDROID CONCEPTS

---

3. Developers translate the Java VM bytecode into Dalvik VM bytecode, which is packaged with other files into a ZIP archive with the .apk extension (the APK file).
4. An Android device or emulator runs the APK file, causing the bytecode to be executed by an instance of a Dalvik VM.

From your standpoint, most of this is hidden by the build tools. You pour Java source code into the top, and the APK file comes out the bottom.

However, there will be places from time to time where the differences between the Dalvik VM and the traditional Java VM will affect application developers, and this book will point out some of them where relevant.

### Processes and Threads

When your application runs, it will do so in its own process. This is not significantly different than any other traditional operating system. Part of Dalvik's magic is making it possible for many processes to be running many Android applications at one time without consuming ridiculous amounts of RAM.

Android will also set up a batch of threads for running your app. The thread that your code will be executed upon, most of the time, is variously called the "main application thread" or the "UI thread". You do not have to set it up, but, as we will see later in the book, you will need to pay attention to what you do and do not do on that thread. You are welcome to fork your own threads to do work, and that is fairly common, though in some places Android handles that for you behind the scenes.

### Don't Be Scared

Yes, this chapter threw a lot of terms at you. We will be going into greater detail on all of them in this book. However, Android is like a jigsaw puzzle with lots of interlocking pieces. To be able to describe one concept in detail, we will need to at least reference some of the others. Hence, this chapter was meant to expose you to terms, in hopes that they will sound vaguely familiar as we dive into the details.

# Choosing Your IDE

---

Before you go much further in your Android endeavors (or, possibly, endeavours, depending upon your preferred spelling), you will need to determine what tools you will use to build your Android applications. Many developers are used to using an integrated development environment (IDE). Android has excellent support for Eclipse, and other IDEs offer varying degrees of Android integration. You do not necessarily have to use an IDE, though, if you do not wish to.

This chapter will outline your options in this area.

## Eclipse

Eclipse is an extremely popular IDE, particularly for Java development. It is also designed to be extensible via an add-in system. To top it off, Eclipse is open source. That combination made it an ideal choice of IDE to get attention from the core Android developer team.

Specifically, to go alongside the Android SDK, Google has published some add-ins for the Eclipse environment. Primary among these is the Android Developer Tools (ADT) add-in, which gives the core of Eclipse awareness of Android.

### What the ADT Gives You

The ADT add-in, in essence, takes regular Eclipse operations and extends them to work with Android projects. For example, with Eclipse, you get:

- New project wizards to create regular Android projects, Android test projects, etc.

---

## CHOOSING YOUR IDE

---

- The ability to run an Android project just like you might run a regular Java application — via the green “run” button in the toolbar — despite the fact that this really involves pushing the Android application over to an emulator or device, possibly even starting up the emulator if it is not running
- Tooltip support for Android classes and methods

Eclipse and the ADT also offers preliminary support for drag-and-drop GUI editing. While this book will also cover the XML files that Eclipse will generate, Eclipse now lets you assemble those XML files by dragging UI components around on the screen, adjusting properties as you go.

The [next chapter contains a section with instructions](#) on how to set up Eclipse for Android development, as part of getting an overall Android development environment established.

Out of all [the shortcut key-combinations for Eclipse](#), two of the most important for readers of this book, particularly if you are following the tutorials, are:

- `<Ctrl>-<Shift>-<O>` will organize your Java import statements, including finding imports for any classes or interfaces you have referenced in your code but have not yet imported
- `<Ctrl>-<Shift>-<F>` will reformat the Java or XML in the current editing window, in accordance with either the default styles in Eclipse or whatever you have modified them to via the Preferences window.

## Alternative IDEs

Other IDEs are slowly getting their equivalents of the ADT, albeit with minimal assistance from Google. For example, IntelliJ’s IDEA has a module for Android – originally commercial, it is part of the open source community edition of IDEA as of version 10. Also, NetBeans has support via the NBAndroid add-on, and reportedly this has advanced substantially in the past year or two.

And, of course, you do not need to use an IDE at all. While this may sound sacrilegious to some, IDEs are not the only way to build applications. Much of what is accomplished via the ADT can be accomplished through command-line equivalents, meaning a shell and an editor is all you truly need. For example, the author of this book did not use an IDE for Android development until 2011.

## IDEs... And This Book

You are welcome to use Eclipse as you work through this book. You are welcome to use another IDE if you wish. You are even welcome to skip the IDE outright and just use an editor.

This book is focused primarily on demonstrating Android capabilities and the APIs for exploiting those capabilities. Hence, the sample code will work with any IDE. However, this book will cover some Eclipse-specific instructions, since it is so popular.

## About App Inventor

You may also have heard of a tool named App Inventor and wonder where it fits in with all of this.

App Inventor was originally created by an education group within Google, as a means of teaching students how to think about programming constructs (branches, loops, etc.) and create interesting output (Android apps) without classic programming in Java or other syntax-based languages. App Inventor is purely drag-and-drop, both of widgets *and application logic*, the latter by means of “blocks” that snap together to form logic chains.

App Inventor was donated by Google to MIT, who has recently re-opened it [to the public](#).

However, App Inventor is a closed system — at the present time, it does not somehow generate Java code that you can later augment. That limits you to whatever App Inventor is natively capable of doing, which, while impressive in its own right, offers a small portion of the total Android SDK capabilities.

This book does not cover the use of App Inventor.



# Tutorial #1 - Installing the Tools

---

Now, let us get you set up with the pieces and parts necessary to build an Android app.

*NOTE:* The instructions presented here are accurate as of the time of this writing. However, the tools change rapidly, and so these instructions may be out of date by the time you read this. Please refer to the [Android Developers Web site](#) for current instructions, using this as a base guideline of what to expect.

## Step #1 - Checking Your Hardware Requirements

Compiling and building an Android application, on its own, is not especially hardware-intensive, except for very large projects. However, there are two commonly-used tools that demand more from your development machine: Eclipse and the Android emulator. Of the two, the emulator poses the bigger problem.

The more RAM you have, the better. 3GB or higher is a very good idea if you intend to use Eclipse and the emulator together.

A faster CPU is also a good idea. However, the Android emulator only utilizes a single core from your development machine. Hence, it is the single-core speed that matters. The best CPU to use is one that can leverage multiple cores to give what amounts to a faster single core, such as Intel's Core i7 with Turbo Boost. For an emulator simulating a larger-screened device (e.g., tablet, television), a Core i7 that can "boost" up to 3.4GHz makes development much more pleasant. Conversely, a CPU like a Core 2 Duo with a 2.5GHz clock speed results in a tablet emulator that is nearly unusable. Smaller screens (e.g., phones) can run acceptably on 2.5GHz and (slightly) slower CPUs.

### Step #2 - Setting Up Java

When you write Android applications, you typically write them in Java source code. That Java source code is then turned into the stuff that Android actually runs (Dalvik bytecode in an APK file).

Hence, the first thing you need to do is get set up with a Java development environment and be ready to start writing Java classes.

#### Install the JDK

You need to obtain and install the official Sun/Oracle Java SE SDK (JDK). You can obtain this from the [Oracle Java Web site](#) for Windows and Linux, and presumably from Apple for OS X. The plain JDK (sans any “bundles”) should suffice. Follow the instructions supplied by Oracle or Apple for installing it on your machine. At the time of this writing, Android supports Java 5 and Java 6. Note that Android does not officially support Java 7, and there have been reports of both success and failure in using Java 7 with Android.

Android also supports the OpenJDK, particularly on Linux environments.

What Android does *not* support are any other Java compilers, including the GNU Compiler for Java (GCJ).

### Step #3 - Install the Android SDK

The Android SDK gives you all the tools you need to create and test Android applications. It comes in two parts: the base tools, plus version-specific SDKs and related add-ons.

#### Install the Base Tools

The Android developer tools can be found on the [Android Developers Web site](#).

The default option at present is for you to download the “ADT Bundle”. This includes a complete copy of Eclipse, along with the base tools and the latest SDK files. If you want a temporary Android development environment, this is probably a fine choice.

## TUTORIAL #1 - INSTALLING THE TOOLS

Otherwise, you will want to click on “Using an Existing IDE” (even if you have not yet installed Eclipse) and download the ZIP or TGZ file presented to you, unpacking it in some likely spot — there is no specific path that is required. Windows users also have the option of running a self-installing EXE file.

### Install the SDKs and Add-Ons

Inside the `tools/` directory of your Android SDK installation from the previous step, you will see an `android` batch file or shell script. On Windows, you may see an “`SDK Manager.exe`” file, perhaps in the root of your ADT bundle installation. In either case, if you run that, you will be presented with the Android SDK Manager:

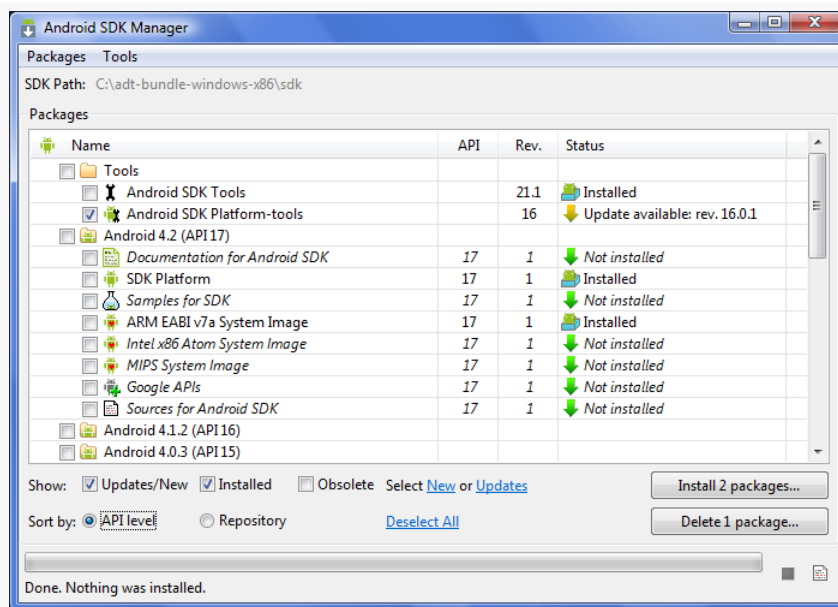


Figure 3: Android SDK Manager

At this point, while you have some of the build tools, you may lack the Java files necessary to compile an Android application. You also lack a few additional build tools, plus the files necessary to run an Android emulator. The checkboxes indicate which packages you want to install — by default, it pre-checks a number of them. If you chose the “ADT Bundle”, some things will already be pre-installed for you.

You will want to check the following items:



## TUTORIAL #1 - INSTALLING THE TOOLS

1. “SDK Platform” for all Android SDK releases you want to test against — for this book API 15 (Android 4.0.3) is recommended, along with any others with which you wish to experiment.
2. “ARM EABI v7a System Image”, if there is an option for that for the API level you chose (should exist for Android 4.0 and higher). You can also download the “Intel x86 Atom System Image”, if one is available to you, though setting that up is [a bit of an advanced topic](#).
3. “Documentation for Android SDK” for the latest Android SDK release.
4. “Samples for SDK” for the latest Android SDK release, and perhaps for older releases if you wish.
5. “Google APIs” for each Android SDK release for which you are downloading the platform (see first bullet).
6. Android SDK Tools and Platform-tools.
7. Android Support Library (in the Extras group at the bottom of the tree).

Then, click the Install button beneath the tree on the right, which brings up a license confirmation dialog:

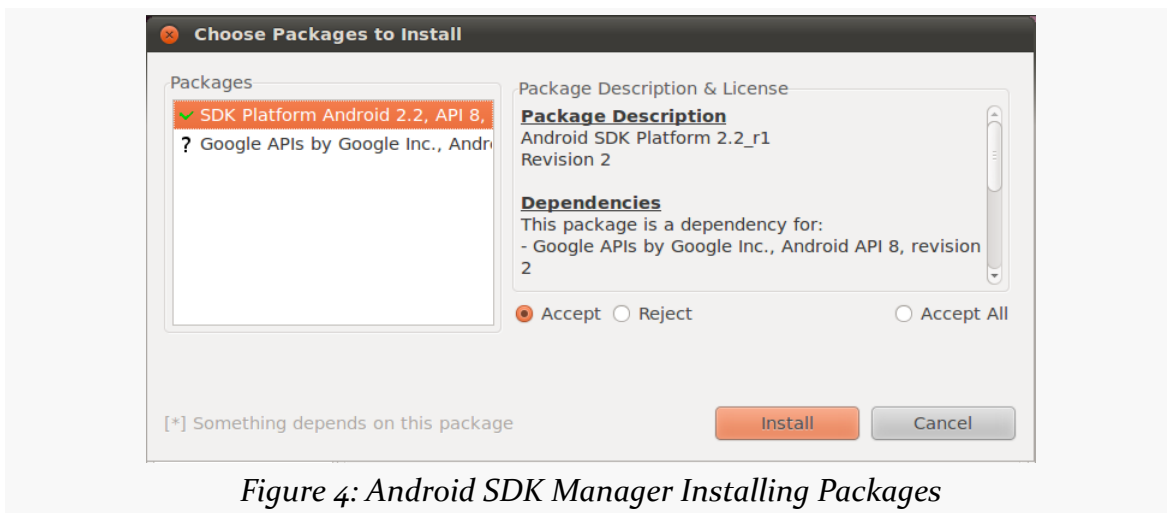


Figure 4: Android SDK Manager Installing Packages

Review and accept the licenses, then click the Install button. At this point, this is a fine time to go get lunch. Or, perhaps dinner. Unless you have a substantial Internet connection, downloading all of this data and unpacking it will take a fair bit of time.

When the download is complete, you can close up the SDK Manager if you wish, though we will use it to set up the emulator in [a later step of this chapter](#).

## Step #4 - Install the ADT for Eclipse

If you will not be using Eclipse for your Android development, you can skip to [the next section](#). Similarly, if you downloaded the “ADT Bundle” and therefore already have a completely-configured Eclipse environment, you can skip to [the next section](#).

If you have not yet installed Eclipse, you will need to do that first. Eclipse can be downloaded from the [Eclipse Web site](#). The “Eclipse IDE for Java Developers” package will work fine. Note that the Android tools require Eclipse 3.6 (Helios) or newer at the time of this writing.

If you already had Eclipse installed, it is a good idea for you to go in and check your compiler compliance level (Preferences > Java > Compiler). That should be set to 1.6. Notably, this allows the use of `@Override` annotations to indicate methods that are implementing a Java interface, rather than truly overriding a superclass method. This annotation is very common in Java code in Android projects (including many of the samples in this book).

Next, you need to install the Android Developer Tools (ADT) plug-in. To do this, go to Help | Install New Software... in the Eclipse main menu. Then, click the Add button to add a new source of plug-ins. Give it some name (e.g., Android) and supply the following URL: `https://dl-ssl.google.com/android/eclipse/`. That should trigger Eclipse to download the roster of plug-ins available from that site:

## TUTORIAL #1 - INSTALLING THE TOOLS

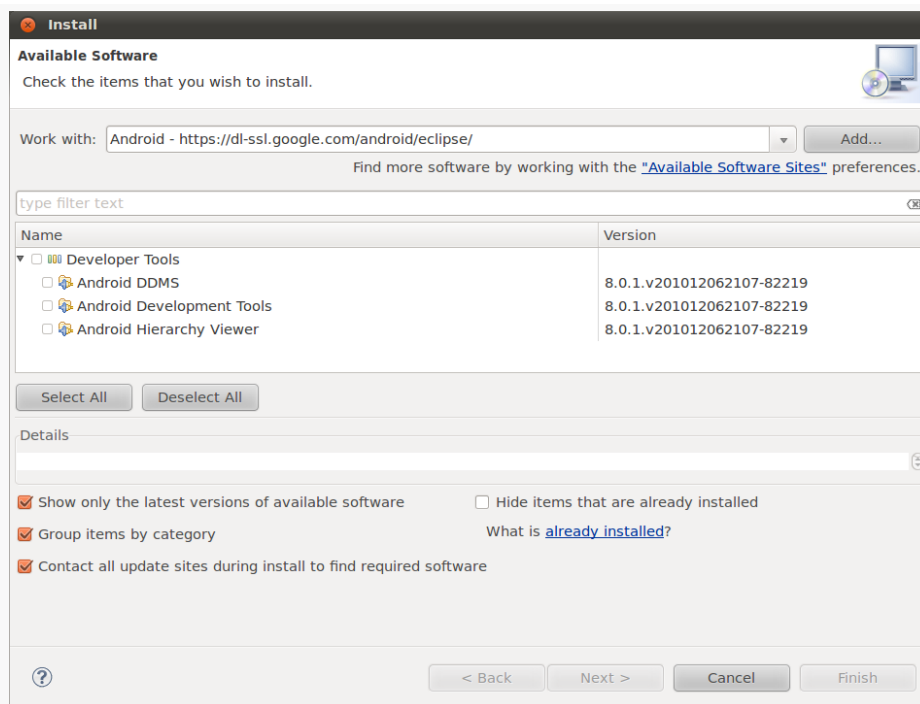


Figure 5: Eclipse ADT plug-in installation

Check the checkbox to the left of “Developer Tools” and click the Next button. Follow the rest of the wizard to review the tools to be downloaded and their respective license agreements. When the Finish button is enabled, click it, and Eclipse will download and install the plug-ins. When done, Eclipse will ask to restart — please let it.

Then, you need to teach ADT where your Android SDK installation is from [the preceding section](#). This should occur on your next restart of Eclipse, via a “welcome wizard”. Otherwise, to do this, choose Window | Preferences from the Eclipse main menu (or the equivalent Preferences option for OS X). Click on the Android entry in the list on the left:

## TUTORIAL #1 - INSTALLING THE TOOLS

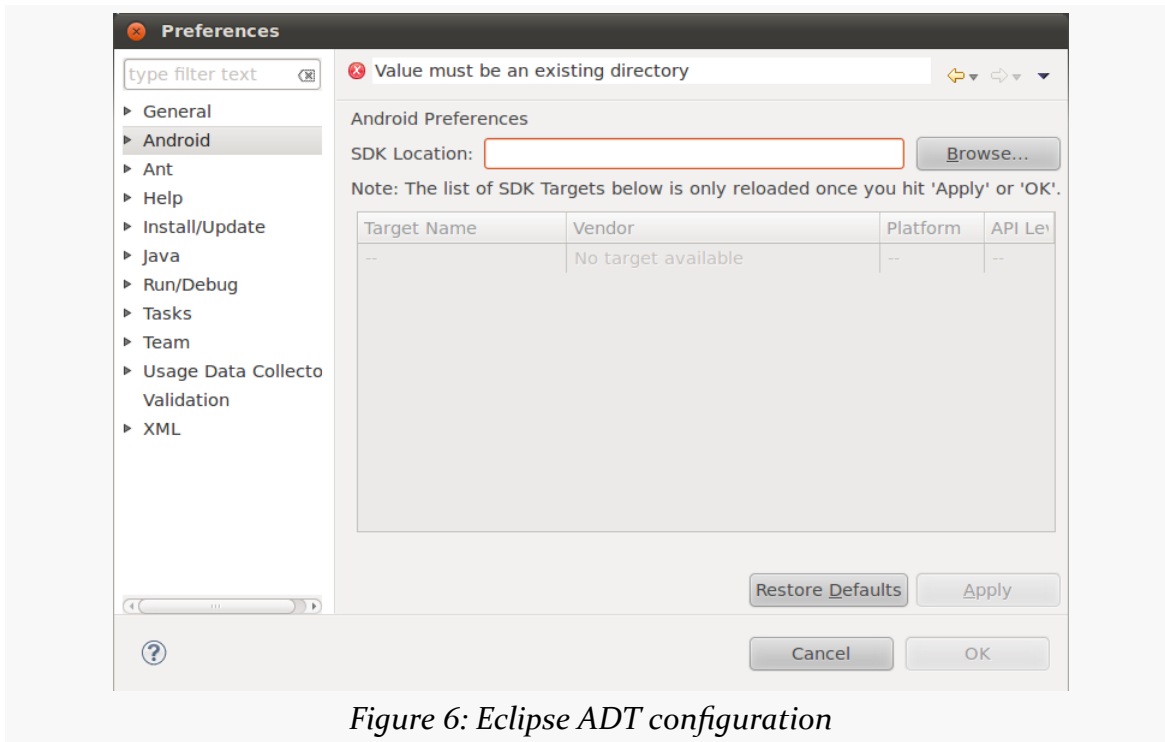


Figure 6: Eclipse ADT configuration

Then, click the Browse... button to find the directory where you installed the SDK. After choosing it, click Apply on the Preferences window, and you should see the Android SDK versions you installed previously. Then, click OK, and the ADT will be ready for use.

### Step #5 - Install Apache Ant

If you will be doing all of your development from Eclipse, you can skip to [the next section](#).

If you wish to develop using command-line build tools, you will need to install Apache Ant. You may have this already from previous Java development work, as it is fairly common in Java projects. However, you will need Ant version 1.8.1, so double-check your current copy (e.g., `ant -version`) to ensure you are on the proper edition.

If you do not have Ant, you can obtain it from the [Apache Ant Web site](#). They have [full installation instructions](#) in the Ant manual, but the basic steps are:

- Unpack the ZIP archive wherever it may make sense on your machine

## TUTORIAL #1 - INSTALLING THE TOOLS

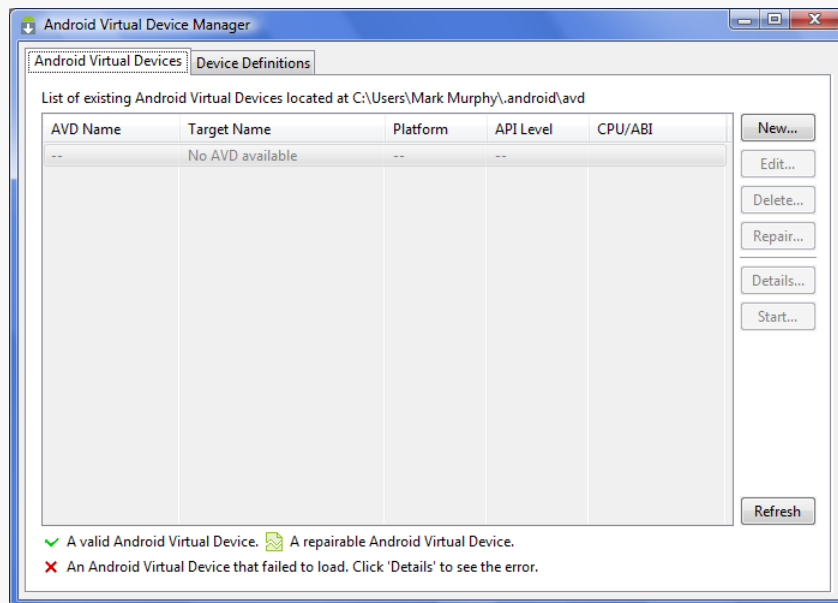
---

- Add a `JAVA_HOME` environment variable, pointing to where your JDK is installed, if you do not have one already
- Add an `ANT_HOME` environment variable, pointing to the directory where you unpacked Ant in the first step above
- Add `$JAVA_HOME/bin` and `$ANT_HOME/bin` to your `PATH` (note: Windows users would add `%JAVA_HOME%\bin` and `%ANT_HOME%\bin`)
- Run `ant -version` to confirm that Ant is installed properly

### Step #6 - Set Up the Emulator

The Android tools include an emulator, a piece of software that pretends to be an Android device. This is very useful for development — not only does it mean you can get started on Android without a device, but the emulator can help test device configurations that you do not own.

The Android emulator can emulate one or several Android devices. Each configuration you want is stored in an “Android virtual device”, or AVD. The AVD Manager is where you create these AVDs. From the command line, you can bring up the AVD Manager via the `android avd` command from your SDK's `tools/` directory. From Eclipse, you start the AVD Manager via its toolbar button or via the Window | AVD Manager main menu option. It starts up on a screen listing the AVDs you have available – initially, the list will be empty:

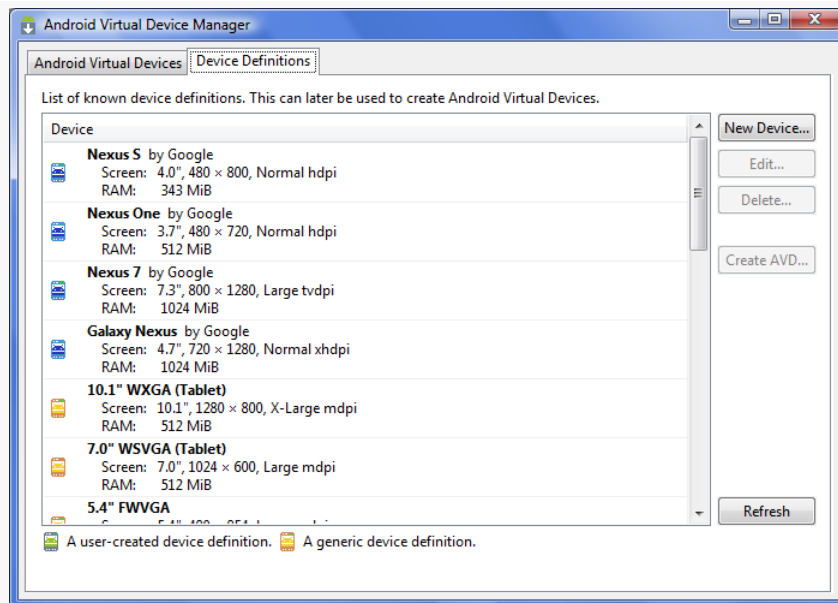


*Figure 7: AVD Manager*

## TUTORIAL #1 - INSTALLING THE TOOLS

---

You will notice that there is a “Device Definitions” tab. This provides a catalog of device hardware configurations that you can use as the starting point for your emulator:

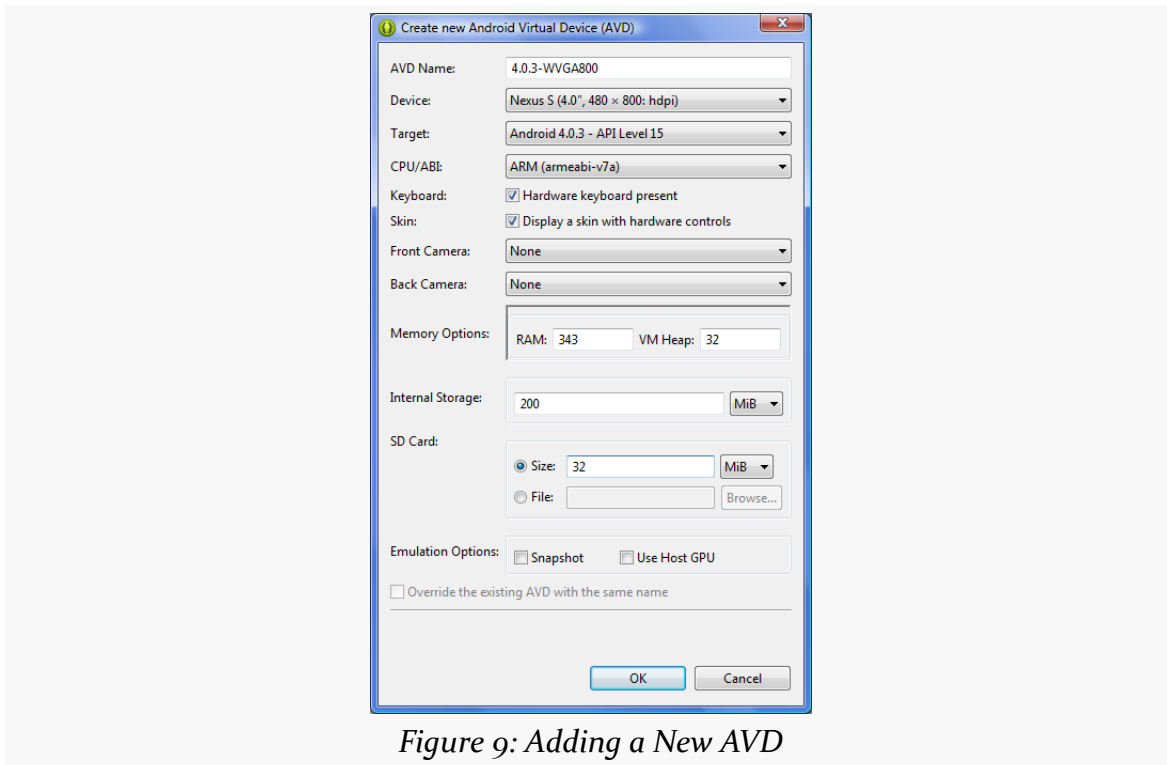


*Figure 8: AVD Manager, Device Definitions Tab*

For now, though, on the “Android Virtual Devices” tab, click the New... button to create a new AVD file. This brings up a dialog where you can configure what this AVD should look and work like:

## TUTORIAL #1 - INSTALLING THE TOOLS

---



You need to provide the following:

1. A name for the AVD. Since the name goes into files on your development machine, you will be limited by filename conventions for your operating system (e.g., no backslashes on Windows).
2. Which one of the available device templates from the “Device Definitions” tab you wish to use. Since the emulator runs slower with higher resolution screens, the Nexus S is a likely candidate — it is a fairly common resolution that will not be too terribly slow.
3. The Android version you want the emulator to run (a.k.a., the “target”). Choose one of the SDKs you installed via the drop-down list. Note that in addition to “pure” Android environments, you will have options based on the third-party add-ons you selected. For example, you probably have some options for setting up AVDs containing the Google APIs, and you will need such an AVD for testing an application that uses Google Maps.
4. The CPU architecture your emulator will emulate. The vast majority of Android devices have ARM CPUs, while the vast majority of development machines have x86 CPUs. However, since setting up the x86 emulator support [is a bit complicated](#), for now, choose ARM.

## TUTORIAL #1 - INSTALLING THE TOOLS

---

5. Whether or not a hardware keyboard is present. Having this checked can ease your data entry on the emulator, as your development machine's keyboard will act as a keyboard for the emulated device.
6. Whether there should be a portion of the emulator window set aside to show hardware controls, such as a D-pad. This is usually a good idea, particularly while you are getting familiar with the Android environment.
7. Values for the memory and internal storage — the defaults are perfectly fine selections.
8. Details about the SD card the emulator should emulate. Since Android devices invariably have some form of “external storage”, you probably want to set up an SD card, by supplying a size in the associated field. However, since a file will be created on your development machine of whatever size you specify for the card, you probably do not want to create a 2GB emulated SD card. 32MB is a nice starting point, though you can go larger if needed.
9. Whether or not “snapshot” mode is enabled. This can speed up restarting the emulator at the cost of hard disk space. For now, leave it unchecked.
10. Whether or not you wish to use the development machine's graphics card (GPU) to accelerate the emulator's graphics. Usually, this helps emulator performance, so checking that is worth trying. If you encounter problems running the emulator, try editing the AVD definition and unchecking this value.

Click the OK button, and your AVD stub will be created.

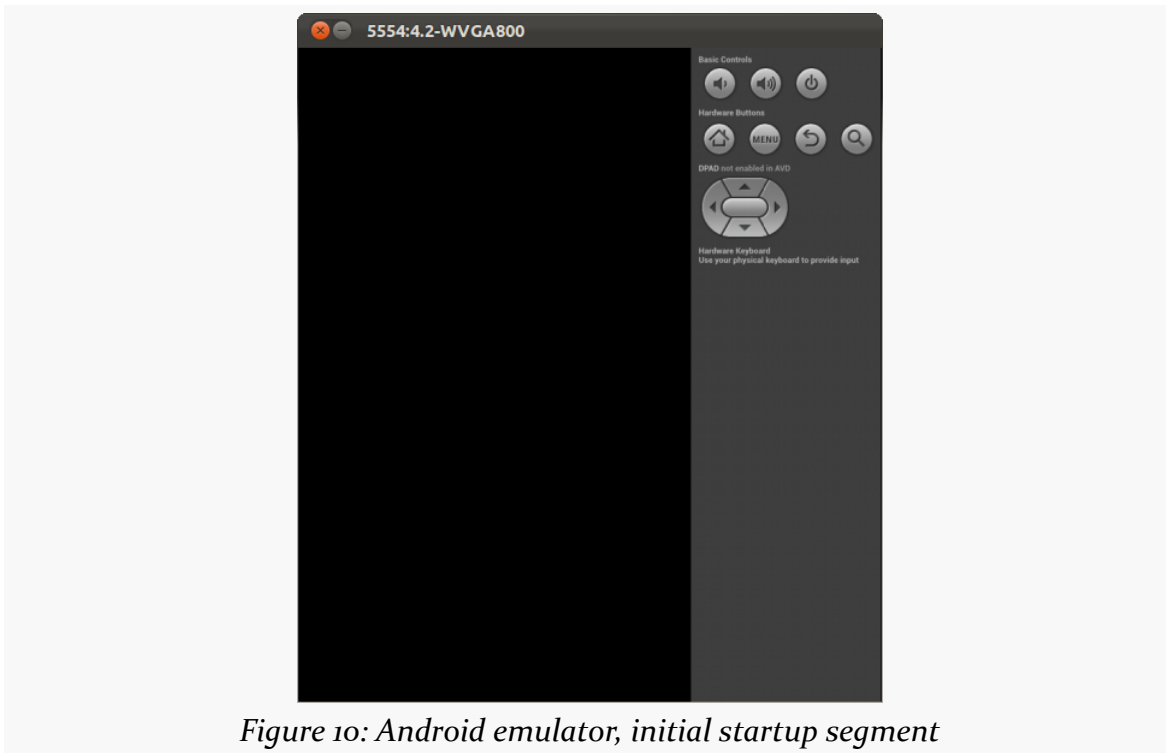
To start the emulator, highlight it in the list and click “Start...”. You can skip the launch options for now and just click Launch. The first time you launch a new AVD, it will take a long time to start up. The second and subsequent times you start the AVD, it will come up a bit faster, and usually you only need to start it up once per day (e.g., when you start development). You do not need to stop and restart the emulator every time you want to test your application, in most cases. Also, Eclipse will automatically start an emulator if you do not have one started and you try running an application.

The emulator will go through a few startup phases, typically first with a plain-text “ANDROID” label (for pre-Android 4.0) or a blank screen (for Android 4.0+):



## TUTORIAL #1 - INSTALLING THE TOOLS

---

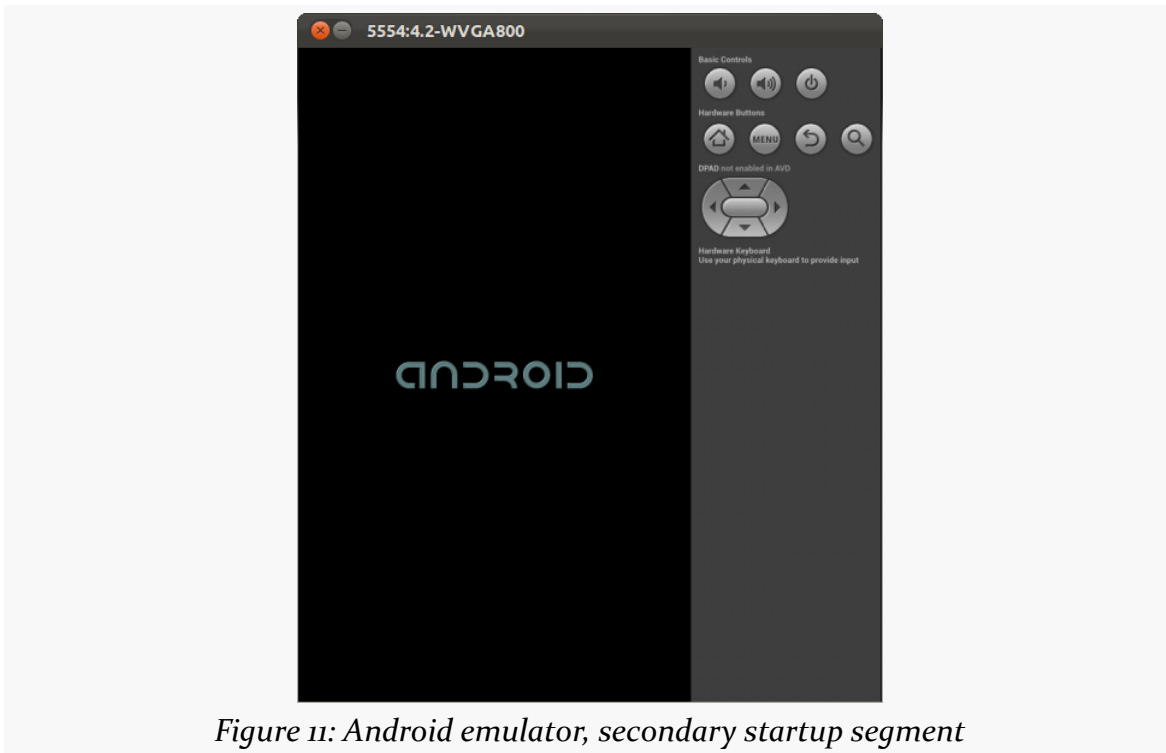


*Figure 10: Android emulator, initial startup segment*

... then a graphical Android logo:

## TUTORIAL #1 - INSTALLING THE TOOLS

---

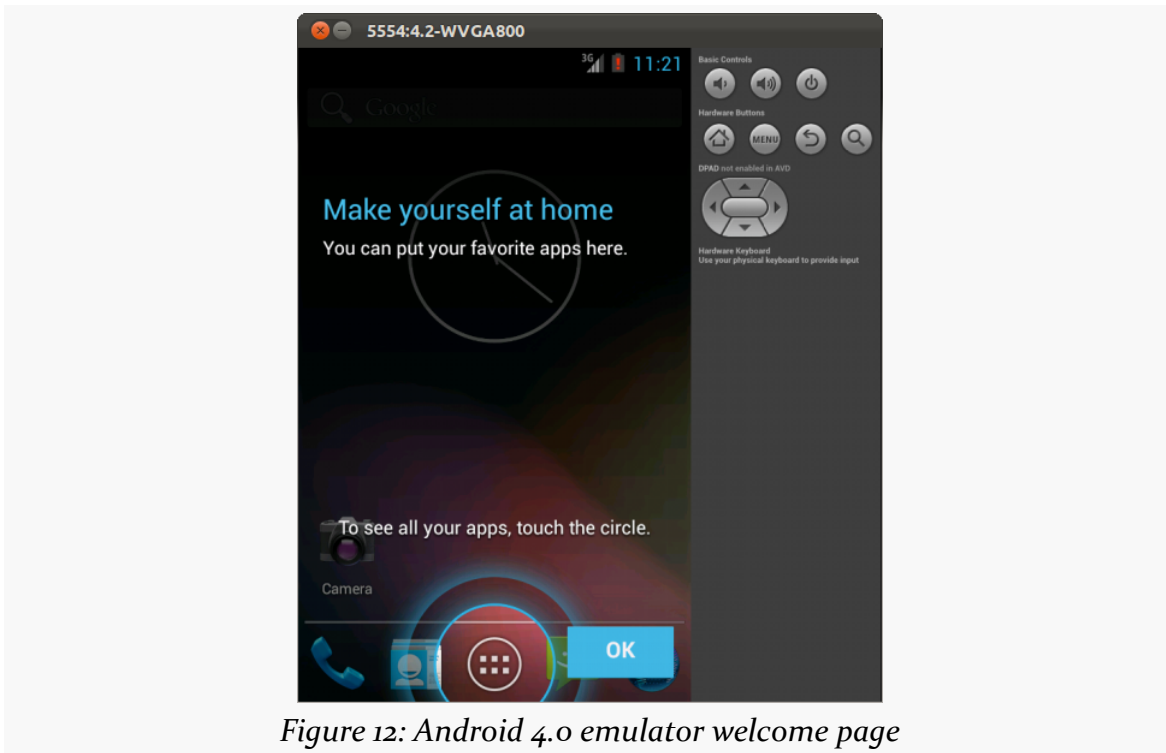


*Figure 11: Android emulator, secondary startup segment*

before eventually landing at the home screen, a welcome page (shown below, for Android 4.0), or the keyguard:

## TUTORIAL #1 - INSTALLING THE TOOLS

---



*Figure 12: Android 4.0 emulator welcome page*

If you get the keyguard (shown below), press the MENU button, or slide the lock on the screen to the right, to get to the emulator's home screen:

## TUTORIAL #1 - INSTALLING THE TOOLS

---

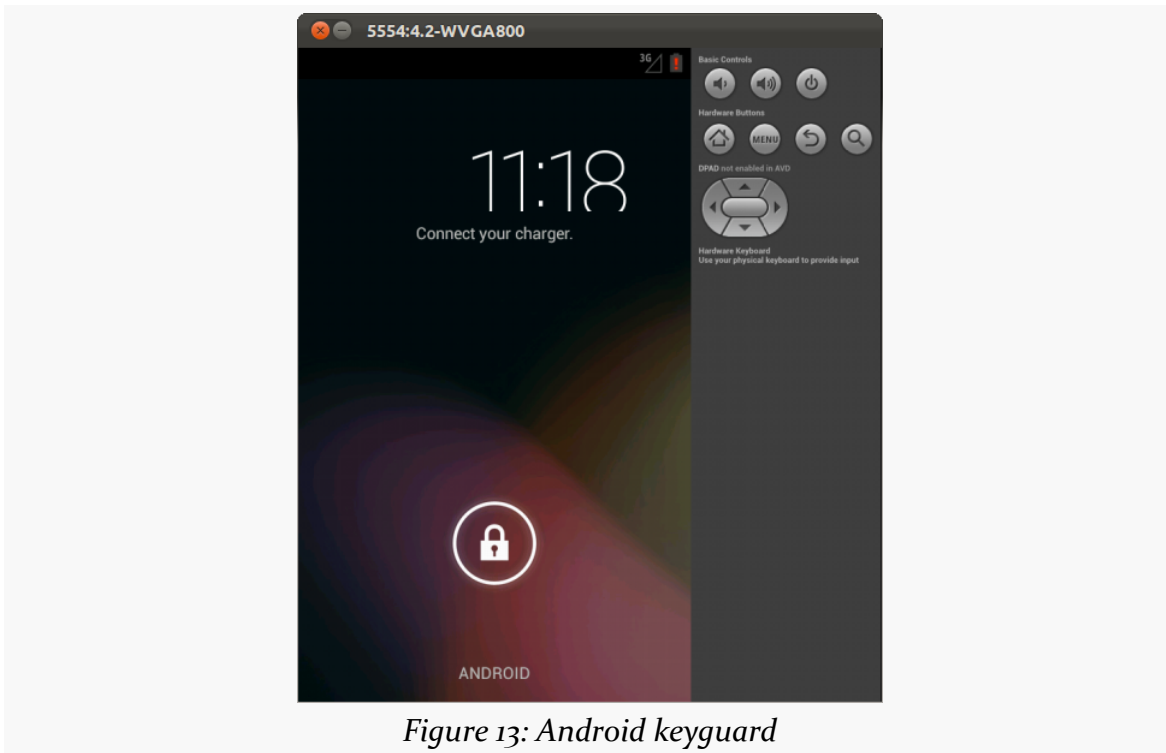


Figure 13: Android keyguard

### Step #7 - Set Up the Device

You do not need an Android device to get started in Android application development. Having one is a good idea before you try to ship an application (e.g., upload it to the Play Store). And, perhaps you already have a device – maybe that is what is spurring your interest in developing for Android.

If you do not have an Android device that you wish to set up for development, skip this step.

The first step to make your device ready for use with development is to go into the Settings application on the device. What happens now depends a bit on your Android version:

- On Android 1.x/2.x, go into Applications, then into Development
- On Android 3.0 through 4.1, go into Developer Settings from the main Settings screen

## TUTORIAL #1 - INSTALLING THE TOOLS

- On Android 4.2 and higher, go into About, tap on the build number seven times, then press BACK, and go into Developer Settings (which was formerly hidden)

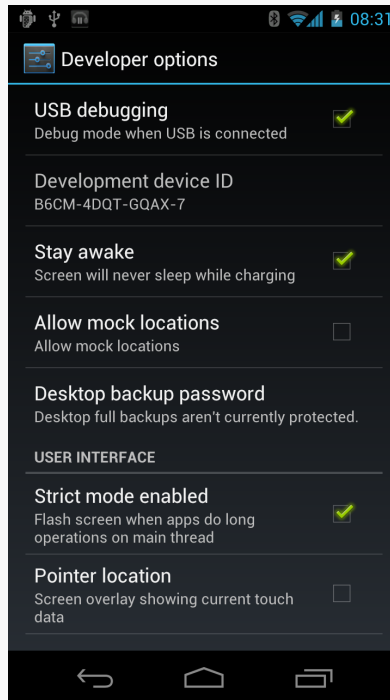


Figure 14: Android 4.0 device development settings

Generally, you will want to enable USB debugging, so you can use your device with the Android build tools. You can leave the other settings alone for now if you wish, though you may find the “Stay awake” option to be handy, as it saves you from having to unlock your phone all of the time while it is plugged into USB.

Note that on Android 4.2.2 and higher devices, before you can actually use the setting you just toggled, you will be prompted to allow USB debugging with your *specific* development machine via a dialog box:

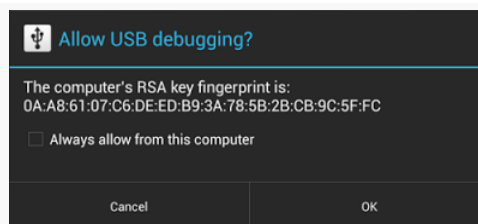


Figure 15: Allow USB Debugging Dialog

## TUTORIAL #1 - INSTALLING THE TOOLS

---

This occurs when you plug in the device via the USB cable and have the driver appropriately set up. That process varies by the operating system of your development machine, as is covered in the following sections.

### Windows

When you first plug in your Android device, Windows will attempt to find a driver for it. It is possible that, by virtue of other software you have installed, that the driver is ready for use. If it finds a driver, you are probably ready to go.

If the driver is not found, here are some options for getting one.

#### Windows Update

Some versions of Windows (e.g., Vista) will prompt you to search Windows Update for drivers. This is certainly worth a shot, though not every device will have supplied its driver to Microsoft.

#### Standard Android Driver

In your Android SDK installation, if you chose to install the “Google USB Driver” package from the SDK Manager, you will find an `extras/google/usb_driver/` directory, containing a generic Windows driver for Android devices. You can try pointing the driver wizard at this directory to see if it thinks this driver is suitable for your device.

#### Manufacturer-Supplied Driver

If you still do not have a driver, the [OEM USB Drivers](#) in the developer documentation may help you find one for download from your device manufacturer. Note that you may need the model number for your device, instead of the model name used for marketing purposes (e.g., GT-P3113 instead of “Samsung Galaxy Tab 2 7.0”).

### OS X and Linux

Odds are decent that simply plugging in your device will “just work”. You can see if Android recognizes your device via running `adb devices` in a shell (e.g., OS X Terminal), where `adb` is in your `platform-tools/` directory of your SDK. If you get output similar to the following, Android detected your device:

## TUTORIAL #1 - INSTALLING THE TOOLS

---

```
List of devices attached
HT9CPP809576 device
```

If you are running Ubuntu (or perhaps other Linux variants), and this command did not work, you may need to add some udev rules. For example, here is a 51-android.rules file that will handle the devices from a handful of manufacturers:

```
SUBSYSTEM=="usb", SYSFS{idVendor}=="0bb4", MODE="0666"
SUBSYSTEM=="usb", SYSFS{idVendor}=="22b8", MODE="0666"
SUBSYSTEM=="usb", SYSFS{idVendor}=="18d1", MODE="0666"
SUBSYSTEMS=="usb", ATTRS{idVendor}=="18d1", ATTRS{idProduct}=="0c01",
MODE="0666", OWNER="[me]"
SUBSYSTEM=="usb", SYSFS{idVendor}=="19d2", SYSFS{idProduct}=="1354", MODE="0666"
SUBSYSTEM=="usb", SYSFS{idVendor}=="04e8", SYSFS{idProduct}=="681c", MODE="0666"
```

Drop that in your /etc/udev/rules.d directory on Ubuntu, then either reboot the computer or otherwise reload the udev rules (e.g., `sudo service udev reload`). Then, unplug and re-plug in the device and see if it is detected.

The CyanogenMod project maintains [a page on their wiki](#) with more on these udev rules, including rules from a variety of manufacturers and devices.

## In Our Next Episode...

... we will [create an Android project](#) that will serve as the basis for all our future tutorials.

# **Tutorial #2 - Creating a Stub Project**

---

Creating an Android application first involves creating an Android “project”. As with many other development environments, the project is where your source code and other assets (e.g., icons) reside. And, the project contains the instructions for your tools for how to convert that source code and other assets into an Android APK file for use with an emulator or device, where the APK is Android’s executable file format.

Hence, in this tutorial, we kick off development of a sample Android application, to give you the opportunity to put some of what you are learning in this book in practice.

## **About Our Tutorial Project**

The application we will be building in these tutorials is called EmPubLite. EmPubLite will be a digital book reader, allowing users to read a digital book like the one that you are reading right now.

EmPubLite will be a partial implementation of [the EmPub reader](#) used for the APK version of this book. EmPub itself is a fairly extensive application, so EmPubLite will have only a subset of its features. The main EmPub app, however, will be used elsewhere in this book to illustrate more advanced Android capabilities.

The “Em” of EmPub and EmPubLite stands for “embedded”. These readers are not designed to read an arbitrary EPUB or MOBI formatted book that you might download from somewhere. Rather, the contents of the book (largely an unpacked EPUB file) will be “baked into” the reader APK itself, so by distributing the APK, you are distributing the book.



### About the Rest of the Tutorials

Of course, you may have little interest in writing a digital book reader app.

The tutorials presented in this book are certainly optional. There is no expectation that you have to write any code in order to get value from the book. These tutorials are here simply as a way to help those of you who “learn by doing” have an opportunity to do just that.

Hence, there are any number of ways that you can use these tutorials:

- You can ignore them entirely. That is not the best answer, but you are welcome to do it.
- You can read the tutorials but not actually do any of the work. This is the best low-effort answer, as it is likely that you will learn things from the tutorials that you might have missed by simply reading the non-tutorial chapters.
- You can follow along the steps and actually build the EmPubLite app.
- You can download the answers from [the book's GitHub repository](#). There, you will find one directory per tutorial, showing the results of having done the steps in that tutorial. For example, you will find a T2-Project/ directory containing a copy of the EmPubLite sample app after having completed the steps found in this tutorial. You can import these projects into Eclipse, examine what they contain, cross-reference them back to the tutorials themselves, and run them.

Any of these are valid options — you will need to choose for yourself what you wish to do.

All that being said, it is a pretty good idea to do at least this tutorial, so you learn how to create an Android project.

### About the Eclipse Instructions

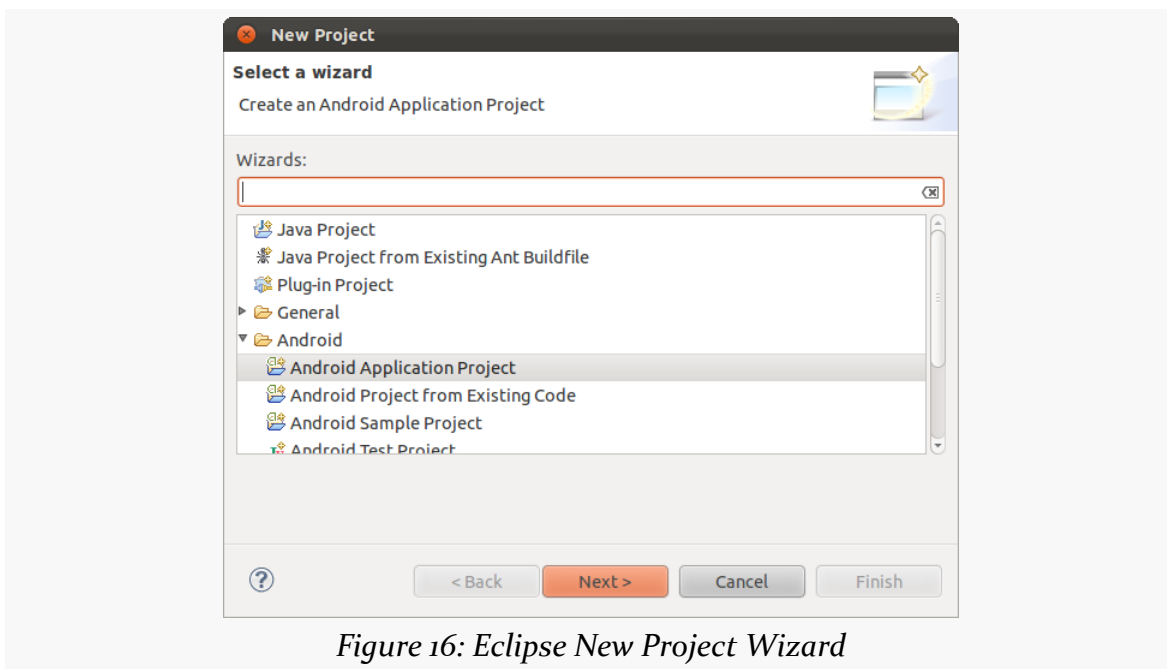
The instructions found in this book assume that you are using the R21 version of the Android developer tools and the ADT plugin for Eclipse.

### Step #1: Creating the Project

First, we need to create the Android project for EmPubLite. You need to decide whether you are going to work with this project from inside the Eclipse IDE or through other tools. If you wish to use Eclipse, follow the instructions in the “Eclipse” section below. If you wish to use a simple editor, follow the “Command Line” instructions below. If you wish to use some other IDE, read through both sections plus the documentation for your IDE to determine how to create a project with the proper settings.

#### Eclipse

From the Eclipse main menu, choose File > New > Project... to bring up the first page of the “New Project” wizard:

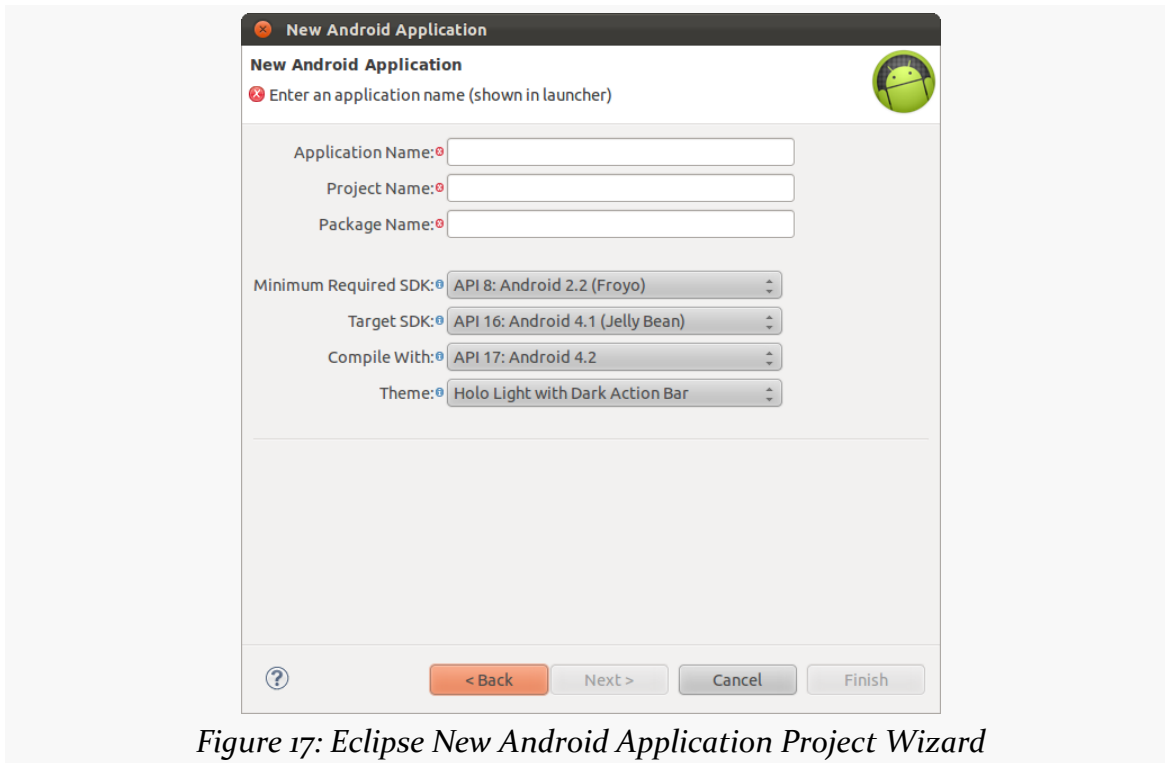


*Figure 16: Eclipse New Project Wizard*

Choose “Android Application Project” from the types of projects and click “Next >” to proceed to the next page of the wizard:

## TUTORIAL #2 - CREATING A STUB PROJECT

---



*Figure 17: Eclipse New Android Application Project Wizard*

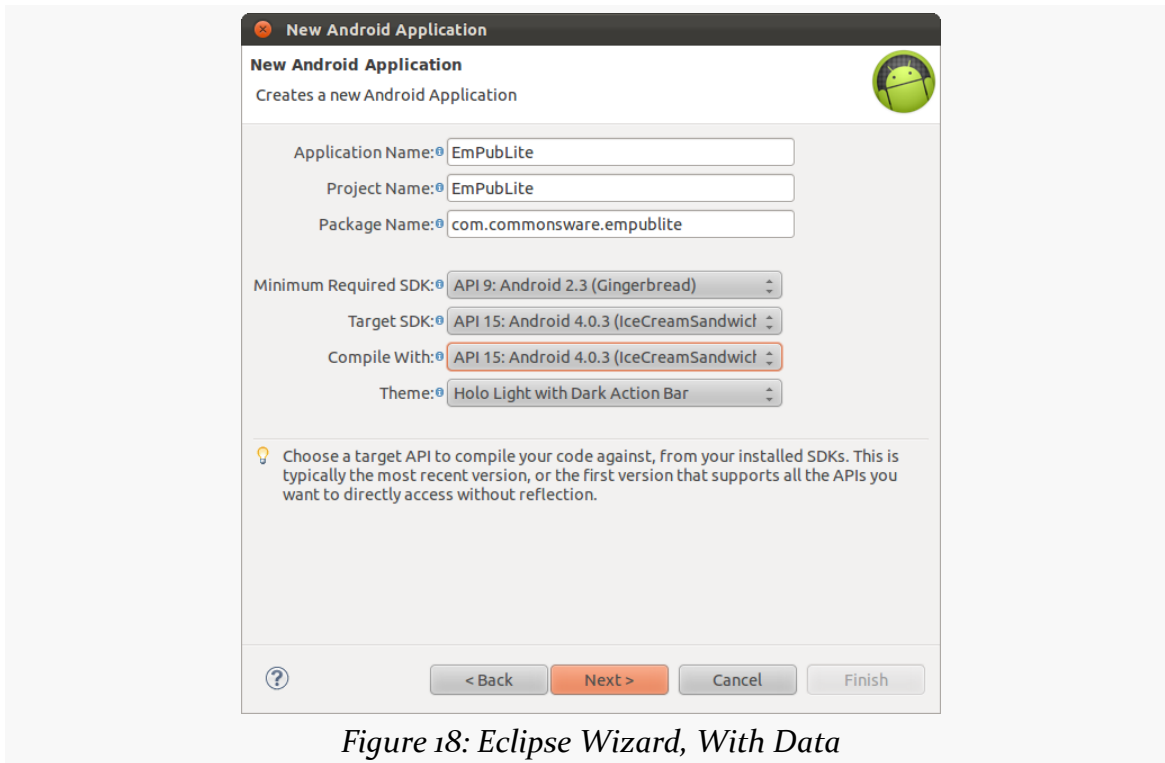
Fill in the following items:

- For “Application Name” and “Project Name”, fill in EmPubLite
- For “Package Name”, fill in com.commonware.empublite
- For “Minimum Required SDK”, choose “API 9: Android 2.3 (Gingerbread)”
- For “Target SDK”, choose “API 15: Android 4.0.3 (IceCreamSandwich)”
- For “Compile With”, choose “API 15: Android 4.0.3 (IceCreamSandwich)” (if you do not have that version, any higher API level should be fine)

The remaining defaults should be fine, leaving you with a dialog akin to this:

## TUTORIAL #2 - CREATING A STUB PROJECT

---



Then, click “Next >” to move to the next page of the wizard:

## TUTORIAL #2 - CREATING A STUB PROJECT

---

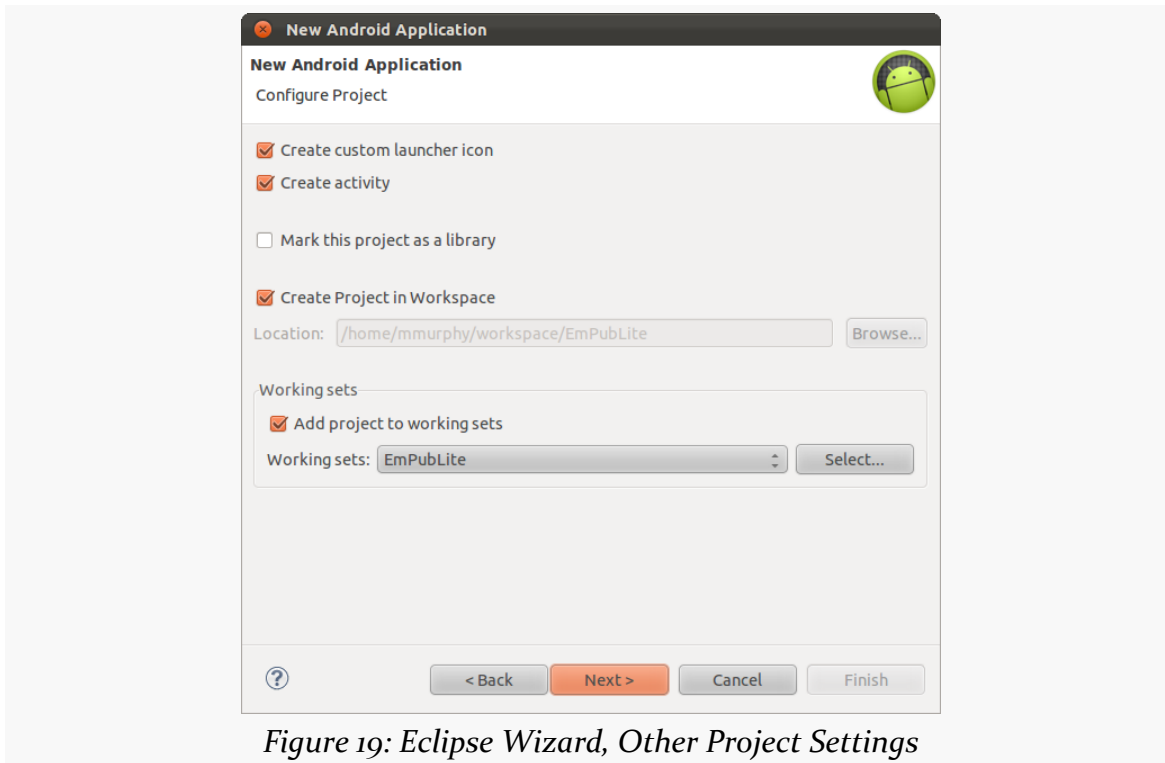


Figure 19: Eclipse Wizard, Other Project Settings

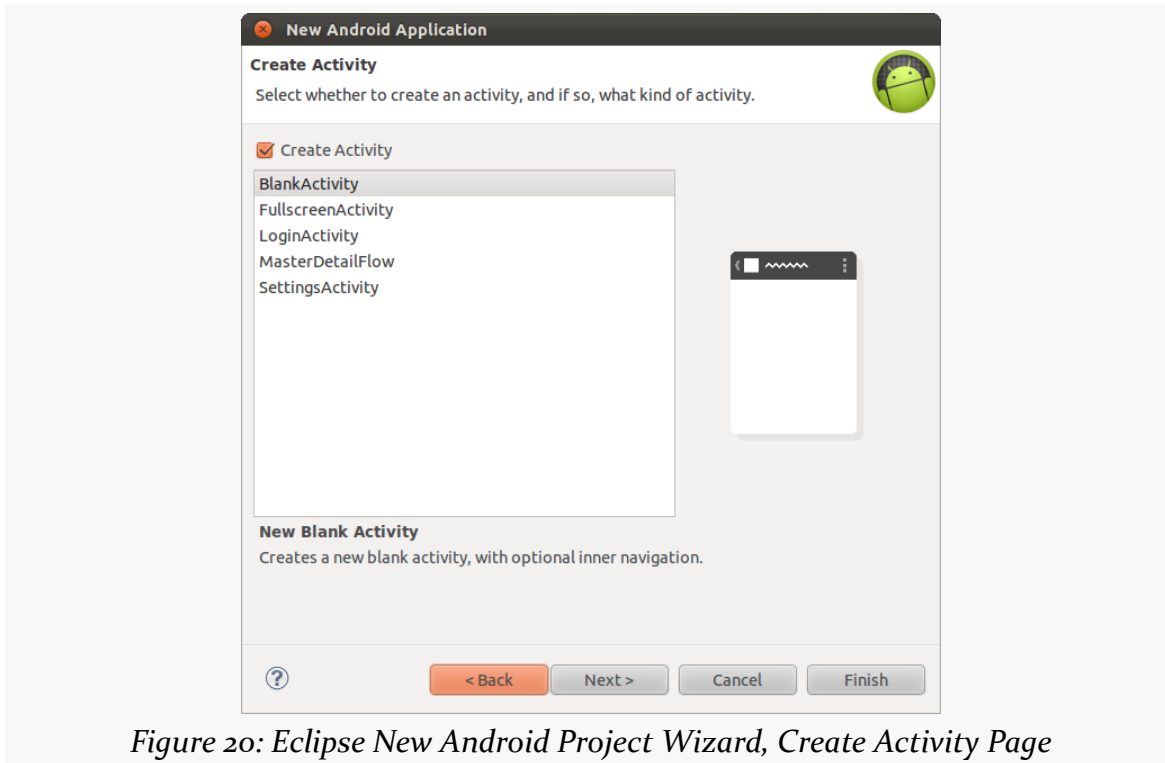
Here:

- Uncheck “Create custom launcher icon”, as we will do this separately later
- Leave “Create activity” checked
- Leave “Mark this project as a library” unchecked
- Choose where you want the project files to be placed, either by leaving “Create Project in Workspace” checked, or unchecking it and choosing a directory on your development machine in which to place the files
- If you are using Eclipse’s working sets, choose your working set (if you do not know what working sets are in Eclipse, you are not using them, and so you can safely ignore this option)

Then, click “Next >” to move to the next page of the wizard:

## TUTORIAL #2 - CREATING A STUB PROJECT

---



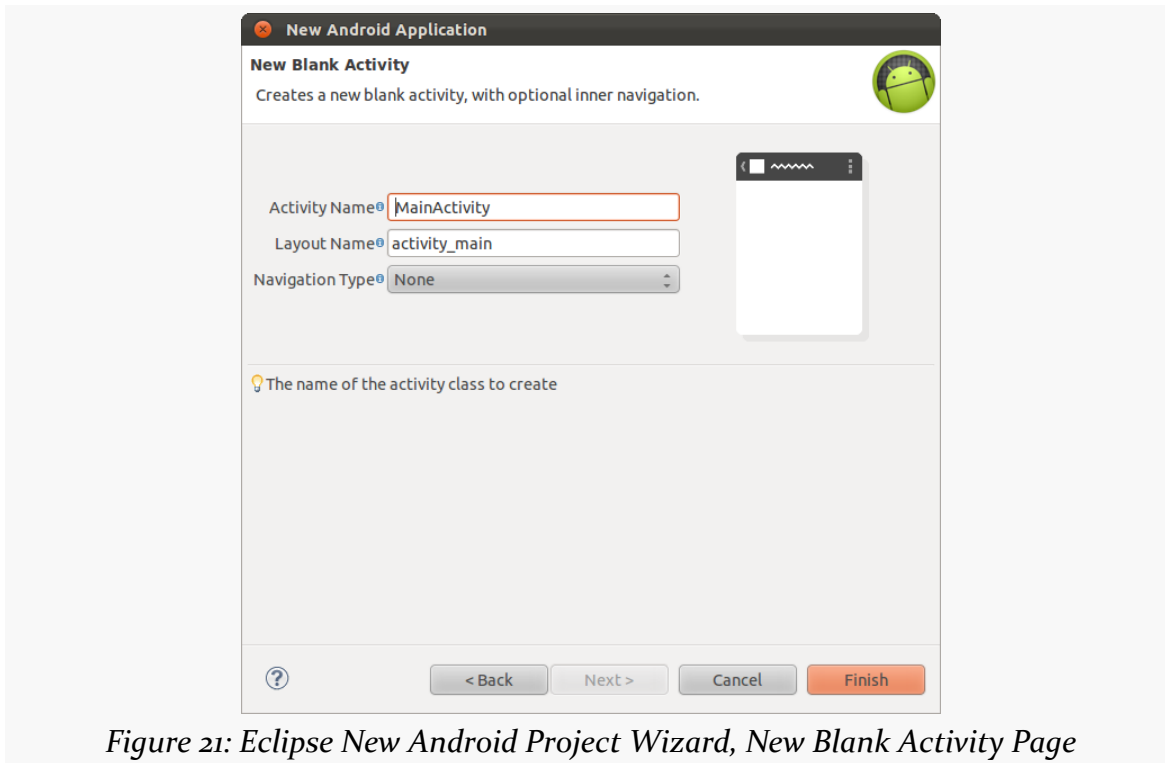
*Figure 20: Eclipse New Android Project Wizard, Create Activity Page*

Here, you choose which template project you want to use as a starting point. Leave the “Create Activity” checkbox checked, and choose “BlankActivity” from the template list.

Then, click “Next >” to move to the next page of the wizard:

## TUTORIAL #2 - CREATING A STUB PROJECT

---



*Figure 21: Eclipse New Android Project Wizard, New Blank Activity Page*

Fill in the following details:

- For “Activity Name”, fill in `EmPubLiteActivity`
- For “Layout Name”, fill in `main`

Leave the rest of the defaults alone.

At this point, you can click the “Finish” button to complete the wizard. Your new `EmPubLite` project should appear in the Eclipse Package Explorer view:

## TUTORIAL #2 - CREATING A STUB PROJECT

---

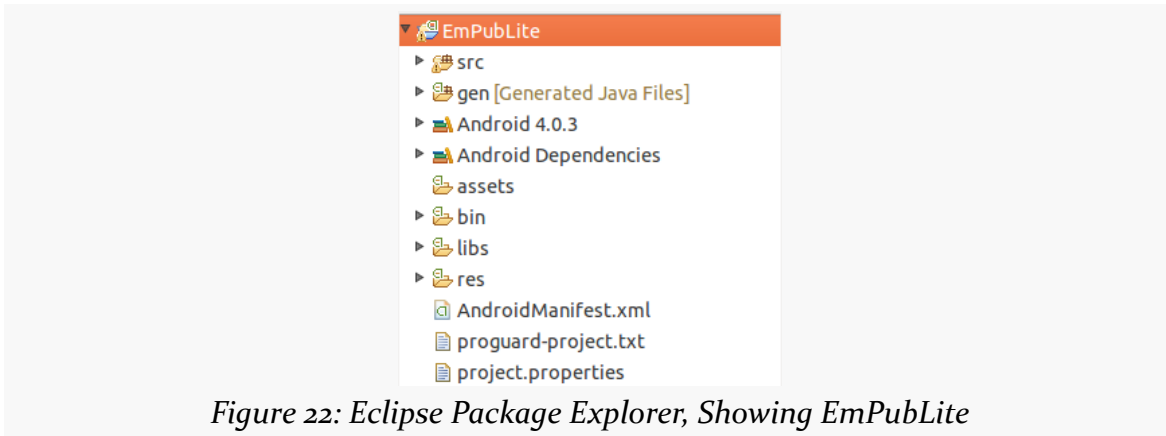


Figure 22: Eclipse Package Explorer, Showing EmPubLite

### Command Line

First, choose where you want to create the project on your filesystem.

Then, execute the following command:

```
android create project -n EmPubLite -t android-15 -p ... -k  
com.commonware.empublite -a EmPubLiteActivity
```

(replacing the ... with the path to your desired project directory)

This will:

- Create the directory you specified
- Create a bunch of files in that directory, using the package name and activity name that you supplied

If `android create project` is not recognized as a command, be sure that you added your SDK's `tools/` and `platform-tools/` directories to your `PATH` environment variable (and restarted your command line, if needed).

### Step #2: Running the Project

Now, we can confirm that our project is set up properly by running it on a device or emulator. Once again, there are separate sections of instructions below for Eclipse versus command-line development — please follow the instructions that are appropriate for you.



### Eclipse

Press the Run toolbar button (usually depicted as a white “play” triangle in a green circle). The first time you run the project, you will see a “Run As” dialog, prompting you to declare how you want to run the app:



*Figure 23: Eclipse Run As Dialog*

Click on “Android Application” and click “OK” to proceed.

At this point, if you have a compatible running emulator or device, the app will be installed and run on it. Otherwise, Eclipse will start up a suitable emulator, from the AVDs you created in [the previous tutorial](#), then will install and run the app on it:

## TUTORIAL #2 - CREATING A STUB PROJECT

---

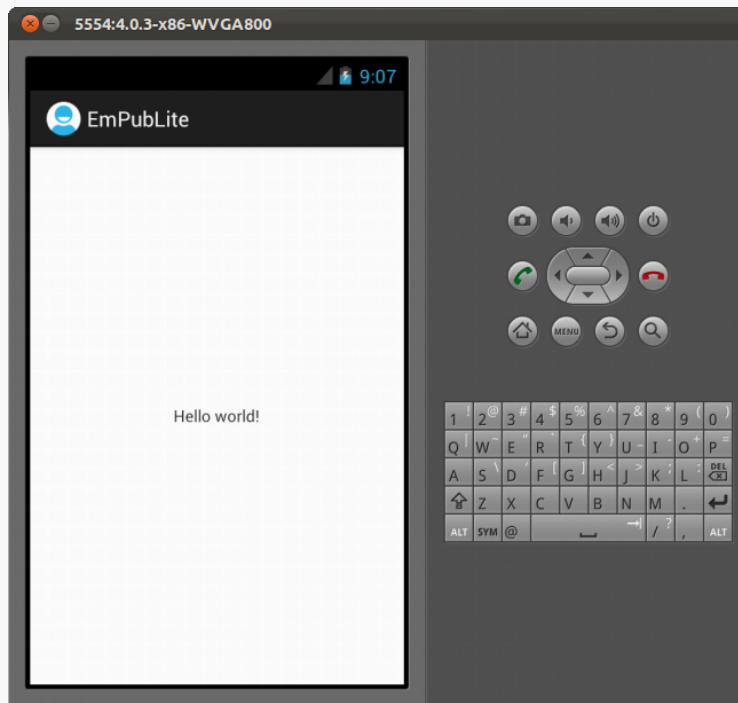


Figure 24: Android 4.0.3 Emulator with EmPubLite

Note that you will have to unlock your device or emulator to actually see the app running — it will not unlock automatically for you.

### Command Line

First, you need to either attach a device or start up a 4.0.3 emulator (we will add support for earlier versions of Android in an upcoming tutorial). If you did not create a 4.0.3 AVD in [the first tutorial](#), and you do not have an Android device running 4.0.3 or higher, go ahead and create the 4.0.3 emulator AVD.

To start the emulator, execute the `android avd` command to bring up the AVD Manager:

## TUTORIAL #2 - CREATING A STUB PROJECT

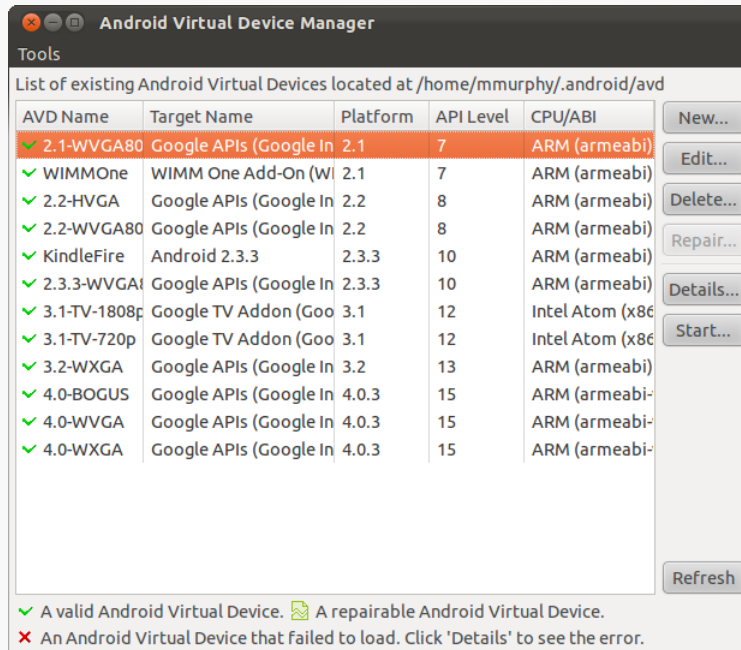


Figure 25: Android AVD Manager

Highlight the AVD you wish to run, then click “Start...”:

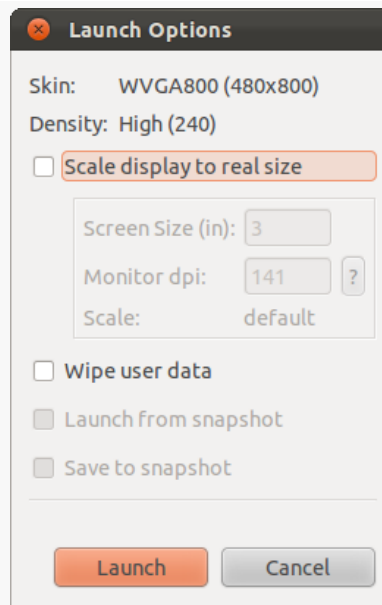


Figure 26: Android AVD Manager Launch Options

## TUTORIAL #2 - CREATING A STUB PROJECT

---

You can, if you wish, just click “Launch” to start up the emulator. Or, you can tailor the output, such as by checking the “Scale display to real size” checkbox, then filling in the desired diagonal size of the emulator screen and the dots-per-inch (dpi) of your development machine’s monitor. Clicking the “?” will bring up an assistant that will help you calculate your monitor’s dots-per-inch.

Once your emulator is launched, from your project directory, run the `ant clean debug install` command. This will:

- Clean out any pre-compiled stuff from previous builds
- Create a debug build of your app
- Install that debug build on your emulator

If you navigate to the launcher of the emulator, you will see your EmPubLite icon — tapping that will bring up the do-nothing stub application.

### In Our Next Episode...

... we will [modify the AndroidManifest.xml file](#) of our tutorial project.



# Contents of Android Projects

---

The Android build system is organized around a *specific* directory tree structure for your Android project, much like any other Java project. The specifics, though, are fairly unique to Android — the Android build tools do a few extra things to prepare the actual application that will run on the device or emulator. Here is a quick primer on the project structure, to help you make sense of it all, particularly for the sample code referenced in this book.

## Root Contents

When you create a new Android project (e.g., via `android create project`), you get several items in the project's root directory, including:

1. `AndroidManifest.xml`, which is an XML file describing the application being built and what components — activities, services, etc. — are being supplied by that application
2. `bin/`, which holds the application once it is compiled (note: this directory will be created when you first build your application)
3. `res/`, which holds “resources”, such as icons, GUI layouts, and the like, that get packaged with the compiled Java in the application
4. `src/`, which holds the Java source code for the application

In addition to the files and directories shown above, you may find any of the following in Android projects:

1. `assets/`, which holds other static files you wish packaged with the application for deployment onto the device
2. `gen/`, where Android's build tools will place source code that they generate

3. `libs/`, which holds any third-party Java JARs your application requires (**NOTE:** this directory may not be created for you by Eclipse, though it is by the command-line option, and you can add it yourself to your Eclipse project when needed)
4. `build.xml` and `*.properties`, which are used as part of the Ant-based command-line build process, if you are not using Eclipse
5. `proguard.cfg` or `proguard-project.txt`, which are used for integration with [ProGuard](#) for obfuscating your Android code
6. Eclipse project files (e.g., `.classpath`), if you are using Eclipse

## The Sweat Off Your Brow

When you created the project (e.g., via `android create project`), you supplied the fully-qualified class name of the “main” activity for the application (e.g., `com.commonsware.android.SomeDemo`). You will then find that your project’s `src/` tree already has the package’s directory tree in place, plus a stub `Activity` subclass representing your main activity (e.g., `src/com/commonsware/android/SomeDemoActivity.java`). You are welcome to modify this file and add others to the `src/` tree as needed to implement your application, and we will demonstrate that countless times as we progress through this book.

The first time you compile the project (e.g., via `ant`), out in the project’s package’s directory, the Android build chain will create `R.java`. This contains a number of constants tied to the various resources you placed out in the `res/` directory tree. You should not modify `R.java` yourself, letting the Android tools handle it for you. You will see throughout many of the samples where we reference things in `R.java` (e.g., referring to a layout’s identifier via `R.layout.main`).

## Resources

You will also find that your project has a `res/` directory tree. This holds “resources” — static files that are packaged along with your application, either in their original form or, occasionally, in a preprocessed form. Some of the subdirectories you will find or create under `res/` include:

1. `res/drawable/` for images (PNG, JPEG, etc.)
2. `res/layout/` for XML-based UI layout specifications
3. `res/menu/` for XML-based menu specifications

4. `res/raw/` for general-purpose files (e.g., an audio clip, a CSV file of account information)
5. `res/values/` for strings, dimensions, and the like
6. `res/xml/` for other general-purpose XML files you wish to ship

Some of the directory names may have suffixes, like `res/drawable-hdpi/`. This indicates that the directory of resources should only be used in certain circumstances — in this case, the drawable resources should only be used on devices with high-density screens.

We will cover all of these, and more, later in this book.

## What You Get Out Of It

When you compile your project (via `ant` or the IDE), the results go into the `bin/` directory under your project root. Specifically:

1. `bin/classes/` holds the compiled Java classes
2. `bin/classes.dex` holds the executable created from those compiled Java classes
3. `bin/yourapp.ap_` holds your application's resources, packaged as a ZIP file (where `yourapp` is the name of your application)
4. `bin/yourapp-*.apk` is the actual Android application (where `*` varies)

The `.apk` file is a ZIP archive containing the `.dex` file, the compiled edition of your resources (`resources.arsc`), any un-compiled resources (such as what you put in `res/raw/`) and the `AndroidManifest.xml` file. If you build a debug version of the application — which is the default — you will have `yourapp-debug.apk` as your APK.





# Inside the Manifest

---

The foundation for any Android application is the manifest file: `AndroidManifest.xml` in the root of your project. Here is where you declare what is inside your application — the activities, the services, and so on. You also indicate how these pieces attach themselves to the overall Android system; for example, you indicate which activity (or activities) should appear on the device’s main menu (a.k.a., launcher).

When you create your application, you will get a starter manifest generated for you. For a simple application, offering a single activity and nothing else, the auto-generated manifest will probably work out fine, or perhaps require a few minor modifications. On the other end of the spectrum, the manifest file for the Android API demo suite is over 1,000 lines long. Your production Android applications will probably fall somewhere in the middle.

## In The Beginning, There Was the Root, And It Was Good

The root of all manifest files is, not surprisingly, a manifest element:

```
<manifest xmlns:android="http://schemas.android.com/apk/res/android"
  package="com.commonware.cwac.richedit.demo"
  android:versionCode="1"
  android:versionName="1.0">
```

Note the android namespace declaration. You will only use the namespace on many of the attributes, not the elements (e.g., `<manifest>`, not `<android:manifest>`).

The biggest piece of information you need to supply on the `<manifest>` element is the package attribute. Here, you can provide the name of the Java package that will be considered the “base” of your application. Your package is a unique identifier for

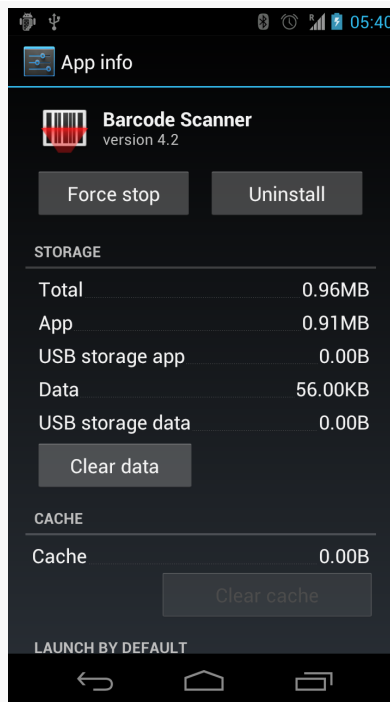
---

## INSIDE THE MANIFEST

---

your application. A device can only have one application installed with a given package, and the Play Store will only list one project with a given package.

Your manifest also specifies `android:versionName` and `android:versionCode` attributes. These represent the versions of your application. The `android:versionName` value is what the user will see for a version indicator in the Applications details screen for your app in their Settings application:



*Figure 27: Barcode Scanner App Screen in Settings, Showing Version 4.2*

Also, the version name is used by the Play Store listing, if you are distributing your application that way. The version name can be any string value you want. The `android:versionCode`, on the other hand, must be an integer, and newer versions must have higher version codes than do older versions. Android and the Play Store will compare the version code of a new APK to the version code of an installed application to determine if the new APK is indeed an update. The typical approach is to start the version code at 1 and increment it with each production release of your application, though you can choose another convention if you wish. During development, you can leave these alone, but when you move to production, these attributes will matter greatly.

## An Application For Your Application

In your initial project's manifest, the primary child of the `<manifest>` element is an `<application>` element.

By default, when you create a new Android project, you get a single `<activity>` element inside the `<application>` element:

```
<?xml version="1.0"?>
<manifest package="com.commonware.android.skeleton"
  xmlns:android="http://schemas.android.com/apk/res/android">

  <application>
    <activity android:label="Now"
      android:name="Now">
      <intent-filter>
        <action android:name="android.intent.action.MAIN" />
        <category android:name="android.intent.category.LAUNCHER" />
      </intent-filter>
    </activity>
  </application>
</manifest>
```

This element supplies `android:name` for the class implementing the activity, `android:label` for the display name of the activity, and (sometimes) an `<intent-filter>` child element describing under what conditions this activity will be displayed. The stock `<activity>` element sets up your activity to appear in the launcher, so users can choose to run it. As we'll see later in this book, you can have several activities in one project, if you so choose.

The `android:name` attribute, in this case, has a bare Java class name (`Now`). Sometimes, you will see `android:name` with a fully-qualified class name (e.g., `com.commonware.android.skeleton.Now`). Sometimes, you will see a Java class name with a single dot as a prefix (e.g., `.Now`). Both `Now` and `.Now` refer to a Java class that will be in your project's package — the one you declared in the `package` attribute of the `<manifest>` element.

## Specifying Versions

As was noted earlier in this chapter, your manifest already contains some version information, about your own application's version. It also contains a `<uses-sdk>` element as a child of the `<manifest>` element to your `AndroidManifest.xml` file, to specify what versions of Android you are supporting.

The most important attribute for your `<uses-sdk>` element is `android:minSdkVersion`. This indicates what is the oldest version of Android you are testing with your application. The value of the attribute is an integer representing the Android [API level](#). So, if you are only testing your application on Android 2.1 and newer versions of Android, you would set your `android:minSdkVersion` to be 7.

You should also specify an `android:targetSdkVersion` attribute. This indicates what version of Android you are thinking of as you are writing your code. If your application is run on a newer version of Android, Android may do some things to try to improve compatibility of your code with respect to changes made in the newer Android. In particular, to get the new “Honeycomb” look-and-feel when running on an Android 3.0 (or higher) device, you need to specify a target SDK version of 11 or higher:

```
<uses-sdk android:minSdkVersion="7" android:targetSdkVersion="11" />
```

## Supporting Multiple Screens

Android devices come with a wide range of screen sizes, from 2.8” tiny smartphones to 46” Google TVs. Android divides these into four buckets, based on physical size and the distance at which they are usually viewed:

1. Small (under 3”)
2. Normal (3” to around 4.5”)
3. Large (4.5” to around 10”)
4. Extra-large (over 10”)

By default, your application will not support small screens, will support normal screens, and may support large and extra-large screens via some automated conversion code built into Android.

To truly support all the screen sizes you want, you should consider adding a `<supports-screens>` element to your manifest. This enumerates the screen sizes you have explicit support for. For example, if you want to support small screens, you will need the `<supports-screens>` element. Similarly, if you are providing custom UI support for large or extra-large screens, you will want to have the `<supports-screens>` element. So, while the starting manifest file works, handling multiple screen sizes is something you will want to think about.

Much more information about providing solid support for all screen sizes, including samples of the `<supports-screens>` element, will be found later in this book as we cover large-screen strategies.

## Other Stuff

As we proceed through the book, you will find other elements being added to the manifest, such as:

- `<uses-permission>`, to tell the user that you need permission to use certain device capabilities, such as accessing the Internet
- `<uses-feature>`, to tell Android that you need the device to have certain features (e.g., a camera), and therefore your app should not be installed on devices lacking such features
- `<uses-library>`, to tell Android that you need the device to support a certain library in firmware (e.g., Google Maps), and therefore your app should not be installed on devices lacking that library

These and other elements will be introduced elsewhere in the book.



# Tutorial #3 - Changing Our Manifest

---

As we build EmPubLite, we will need to make a number of changes to our project's manifest. In this tutorial, we will take care of a couple of these changes, to show you how to manipulate the `AndroidManifest.xml` file. Future tutorials will make yet more changes.

This is a continuation of the work we did in [the previous tutorial](#).

You can find [the results of the previous tutorial](#) and [the results of this tutorial](#) in [the book's GitHub repository](#).

## Step #1: Supporting Screens

Our application will restrict its supported screen sizes. Tablets make for ideal ebook readers. Phones can also be used, but the smaller the phone, the more difficult it will be to come up with a UI that will let the user do everything that is needed, yet still have room for more than a sentence or two of the book at a time.

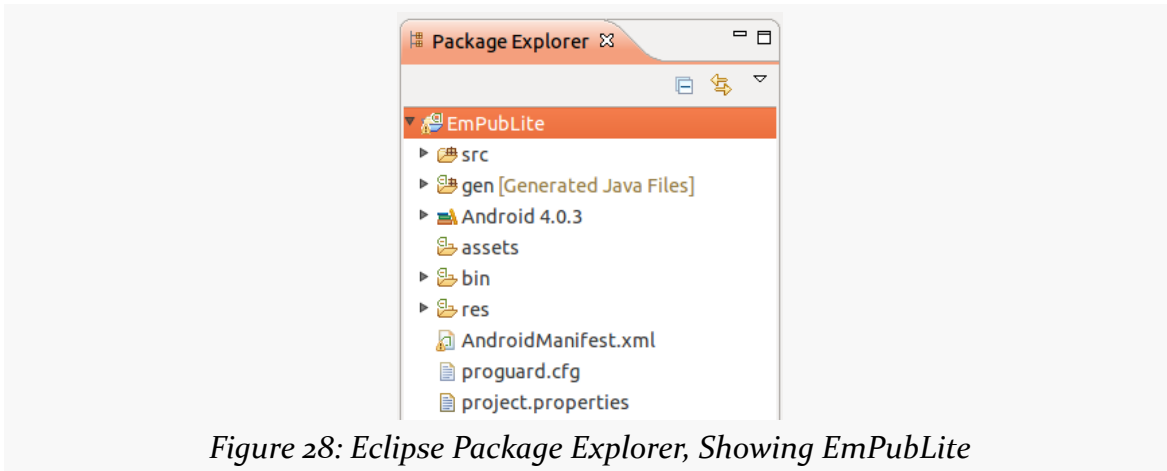
We will get into screen size strategies and their details [later in this book](#). For the moment, though, we will add a `<supports-screens>` element to keep our application off “small” screen devices (under 3” diagonal size).

If you wish to make this change using Eclipse's structured manifest editor, follow the instructions in the “Eclipse” section below. Otherwise, follow the instructions in the “Outside of Eclipse” section (appears after the “Eclipse” section).



### Eclipse

In the Package Explorer view in Eclipse, find the `AndroidManifest.xml` entry and double-click on it.



*Figure 28: Eclipse Package Explorer, Showing EmPubLite*

Double-clicking on the file will bring the file up in Eclipse's default editor for that type of file. In the case of `AndroidManifest.xml`, this will be a structured editor for manifest settings:

## TUTORIAL #3 - CHANGING OUR MANIFEST

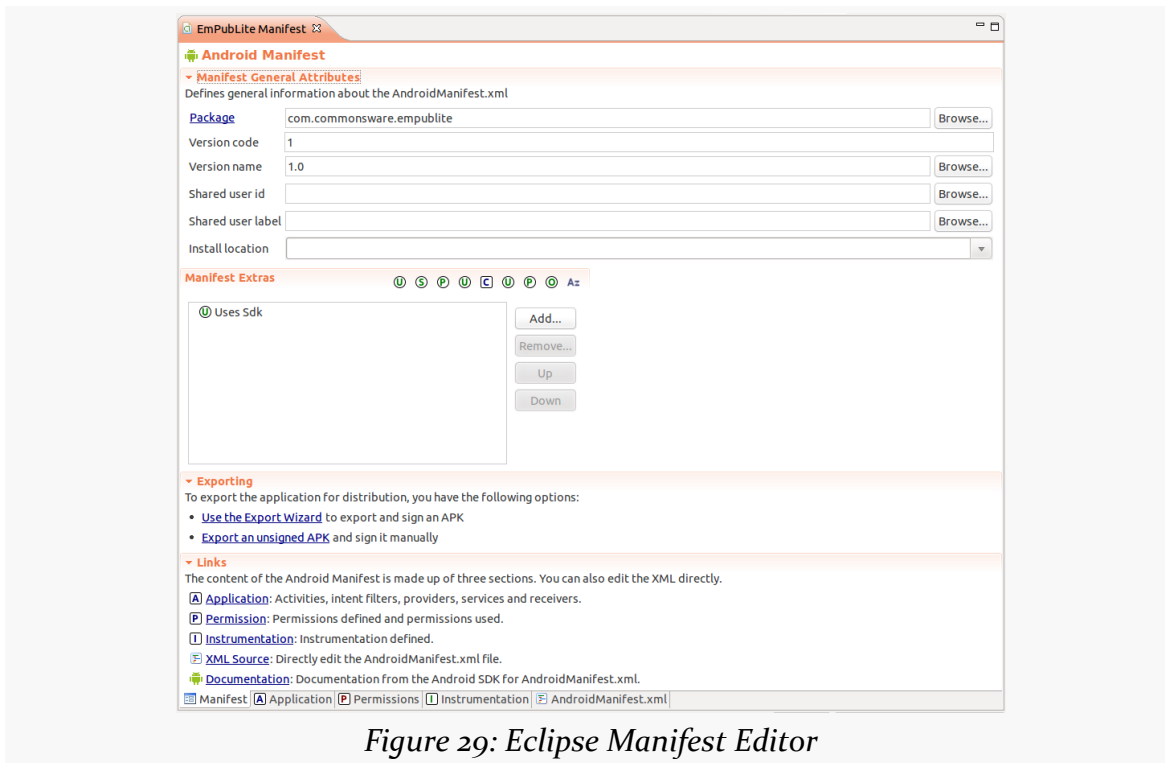
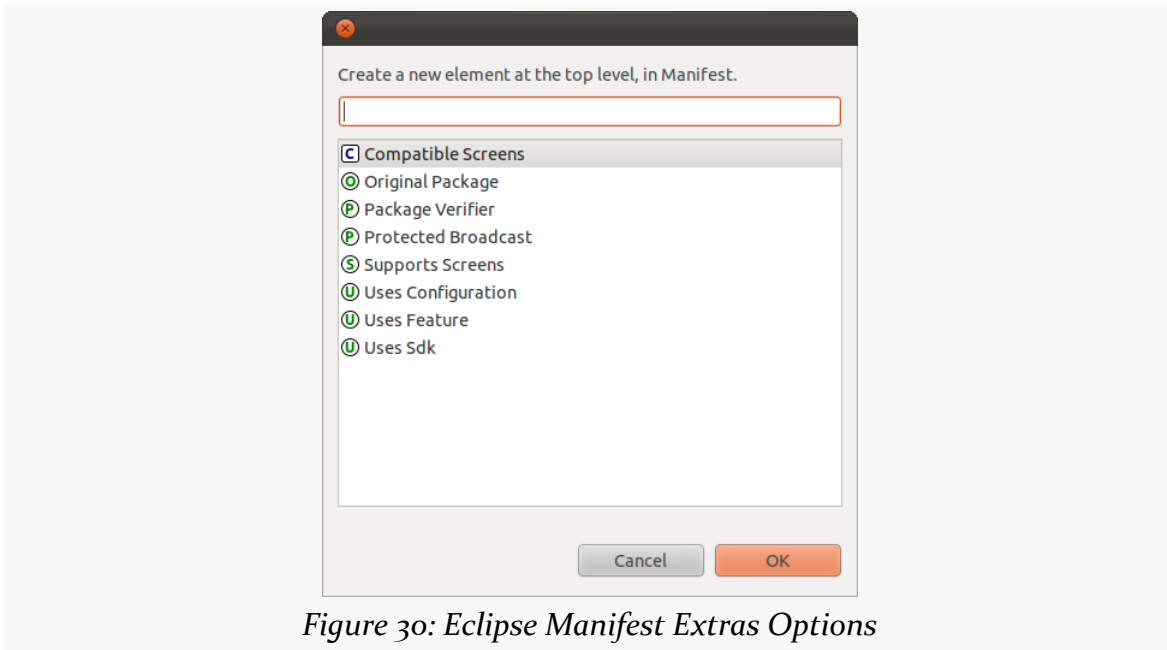


Figure 29: Eclipse Manifest Editor

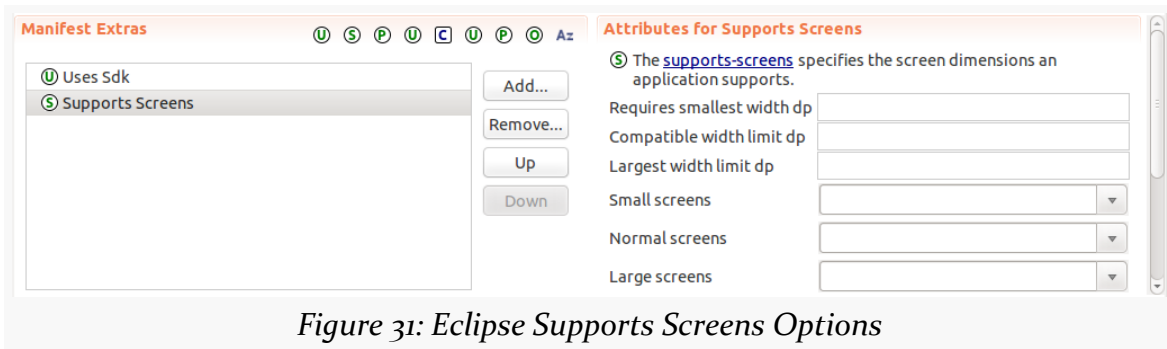
You will notice that there is a series of sub-tabs at the bottom of the editor, labeled “Manifest”, “Application”, “Permissions”, and so on. These allow you to adjust different portions of the manifest file. The right-most sub-tab, “AndroidManifest.xml”, allows you to edit the raw XML of this file directly, if you so choose. This is a fairly typical pattern with the Eclipse editors: one or more sub-tabs providing a structured way of editing the data, and the right-most sub-tab providing raw access to the underlying XML.

In the “Manifest Extras” area of the “Manifest” sub-tab in our open manifest editor, click the “Add...” button to the right of the extras list, to bring up a dialog of what sort of extras we can add:

## TUTORIAL #3 - CHANGING OUR MANIFEST



Click on “Supports Screens”, then click “OK” to close the dialog and add a “Supports Screens” entry in the “Manifest Extras” list. That entry will be pre-selected by the editor, showing the available configuration options on the right:



Note that the attributes list on the right may have vertical scrollbar, as there are several things we can stipulate on the <supports-screens> element, and not all can fit on the editor at once given the editor’s design.

Using that scrollbar as needed, toggle the “Small screens” value to false and the “Normal screens”, “Large screens”, and “Xlarge screens” values to true:

## TUTORIAL #3 - CHANGING OUR MANIFEST

---

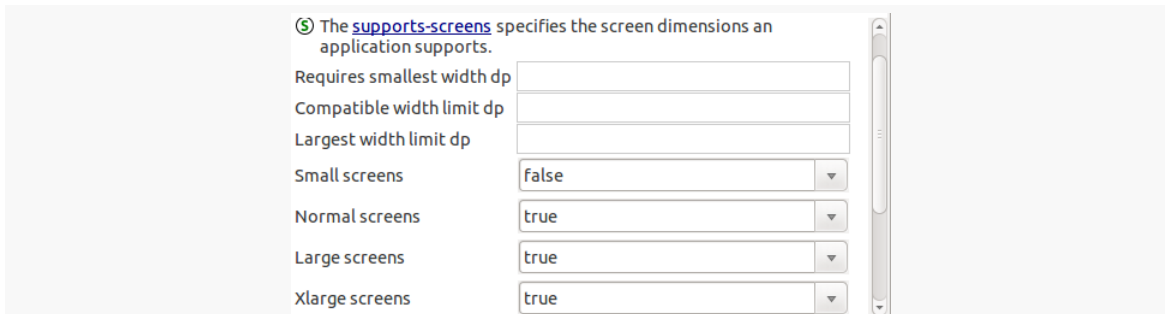


Figure 32: Eclipse Supports Screens Options, Adjusted

Then you can save the file, via the main menu, the Save toolbar icon, or <Ctrl>-<S>.

### Outside of Eclipse

As a child of the root <manifest> element, add a <supports-screens> element as follows:

```
<supports-screens
  android:largeScreens="true"
  android:normalScreens="true"
  android:smallScreens="false"
  android:xlargeScreens="true"/>
```

## Step #2: Validating our Minimum and Target SDK Versions

If you created your project from Eclipse, then in the “Manifest Extras” area of the “Manifest” sub-tab in our open manifest editor, you should have a Uses Sdk entry. Clicking on that should show that your minimum SDK version is set to 9 and that your target SDK version is 15:

## TUTORIAL #3 - CHANGING OUR MANIFEST

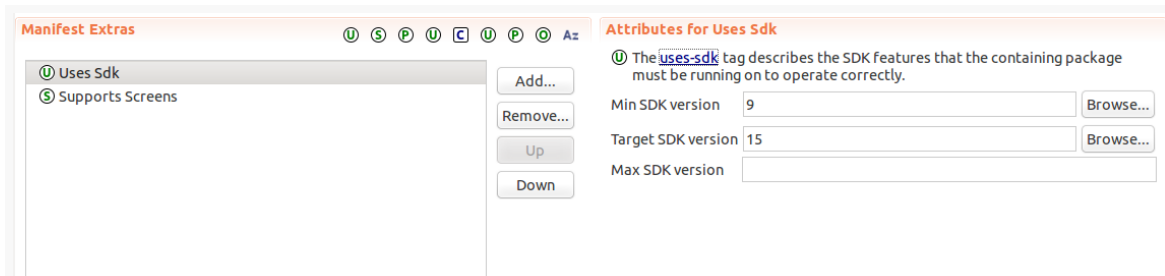


Figure 33: Eclipse Uses Sdk Options

If you created your project from the command line, though, this data may not exist. You will need to add a `<uses-sdk android:minSdkVersion="9" android:targetSdkVersion="15"/>` element to your manifest, as a child of the root `<manifest>` element.

The entire manifest file, at this point should look a bit like:

```
<?xml version="1.0" encoding="utf-8"?>
<manifest xmlns:android="http://schemas.android.com/apk/res/android"
    package="com.commonware.empublite"
    android:versionCode="1"
    android:versionName="1.0">

    <uses-sdk
        android:minSdkVersion="9"
        android:targetSdkVersion="15"/>

    <supports-screens
        android:largeScreens="true"
        android:normalScreens="true"
        android:smallScreens="false"
        android:xlargeScreens="true"/>

    <application
        android:allowBackup="true"
        android:icon="@drawable/ic_launcher"
        android:label="@string/app_name"
        android:theme="@style/AppTheme">
        <activity
            android:name="EmPubLiteActivity"
            android:label="@string/app_name">
            <intent-filter>
                <action android:name="android.intent.action.MAIN"/>

                <category android:name="android.intent.category.LAUNCHER"/>
            </intent-filter>
        </activity>
    </application>
```

```
</manifest>
```

### In Our Next Episode...

... we will [make some changes to the resources](#) of our tutorial project



# Some Words About Resources

---

It is quite likely that by this point in time, you are “chomping at the bit” to get into actually writing some code. This is understandable. That being said, before we dive into the Java source code for our stub project, we really should chat briefly about resources.

Resources are static bits of information held outside the Java source code. Resources are stored as files under the `res/` directory in your Android project layout. Here is where you will find all your icons and other images, your externalized strings for internationalization, and more.

These are not only separate from the Java source code because they are different in format. They are separate because you can have *multiple* definitions of a resource, to use in different circumstances. For example, with internationalization, you will have strings for different languages. Your Java code will be able to remain largely oblivious to this, as Android will choose the right resource to use, from all candidates, in a given circumstance (e.g., choose the Spanish string if the device’s locale is set to Spanish).

We will cover all the details of these resource sets [later in the book](#). Right now, we need to discuss the resources in use by our stub project, plus one more.

## String Theory

Keeping your labels and other bits of text outside the main source code of your application is generally considered to be a very good idea. In particular, it helps with internationalization (I18N) and localization (L10N). Even if you are not going to translate your strings to other languages, it is easier to make corrections if all the strings are in one spot instead of scattered throughout your source code.



### Plain Strings

Generally speaking, all you need to do is have an XML file in the `res/values` directory (typically named `res/values/strings.xml`), with a `resources` root element, and one child `string` element for each string you wish to encode as a resource. The `string` element takes a `name` attribute, which is the unique name for this string, and a single text element containing the text of the string:

```
<resources>
  <string name="quick">The quick brown fox...</string>
  <string name="laughs">He who laughs last...</string>
</resources>
```

The only tricky part is if the string value contains a quote or an apostrophe. In those cases, you will want to escape those values, by preceding them with a backslash (e.g., These are the times that try men\'s souls). Or, if it is just an apostrophe, you could enclose the value in quotes (e.g., "These are the times that try men's souls.").

For example, our stub project's `strings.xml` file looks like this:

```
<?xml version="1.0" encoding="utf-8"?>
<resources>

  <string name="app_name">EmPubLite</string>
  <string name="hello_world">Hello world!</string>
  <string name="menu_settings">Settings</string>

</resources>
```

We will reference these string resources from various locations, in our Java source code and elsewhere. For example, the `app_name` string resource is used in our `AndroidManifest.xml` file:

```
<?xml version="1.0" encoding="utf-8"?>
<manifest xmlns:android="http://schemas.android.com/apk/res/android"
  package="com.commonware.empublite"
  android:versionCode="1"
  android:versionName="1.0">

  <uses-sdk
    android:minSdkVersion="9"
    android:targetSdkVersion="15"/>

  <supports-screens
    android:largeScreens="true"
    android:normalScreens="true"
```

## SOME WORDS ABOUT RESOURCES

---

```
    android:smallScreens="false"
    android:xlargeScreens="true"/>

<application
    android:allowBackup="true"
    android:icon="@drawable/ic_launcher"
    android:label="@string/app_name"
    android:theme="@style/AppTheme">
    <activity
        android:name="EmPubLiteActivity"
        android:label="@string/app_name">
        <intent-filter>
            <action android:name="android.intent.action.MAIN"/>

            <category android:name="android.intent.category.LAUNCHER"/>
        </intent-filter>
    </activity>
</application>

</manifest>
```

Here, the `android:label` attribute of our `<application>` element refers to the `app_name` string resource. This will appear in a few places in our application, notably in the list of installed applications in Settings. So, if you wish to change how your application's name appears in these places, simply adjust the `app_name` string resource to suit.

The syntax `@string/app_name` tells Android “find the string resource named `app_name`”. This causes Android to scan the appropriate `strings.xml` file (or any other file containing string resources in your `res/values/` directory) to try to find `app_name`.

### Styled Text

Many things in Android can display rich text, where the text has been formatted using some lightweight HTML markup, such as `<b>`, `<i>`, and `<u>`. Your string resources support this, simply by using the HTML tags as you would in a Web page:

```
<resources>
    <string name="b">This has <b>bold</b> in it.</string>
    <string name="i">Whereas this has <i>italics</i>!</string>
</resources>
```

Unfortunately, the list of supported tags is undocumented. Based on recent Android implementations, it will mostly be your inline markup rules (e.g., `<tt>`, `<h1>`, `<small>`, `<strike>`).

### The Directory Name

Our string resources in our stub project are in the `res/values/strings.xml` file. This directory (`res/values/`) means that the string resources in that directory will be valid for any sort of situation, including any locale for the device. We will need additional directories, with distinct `strings.xml` files, to support other languages. We will cover how to do that later in this book.

### String Resources and Eclipse

When you double-click on a string resource file, like `res/values/strings.xml`, you will be greeted with a list of all the string resources that have been defined:

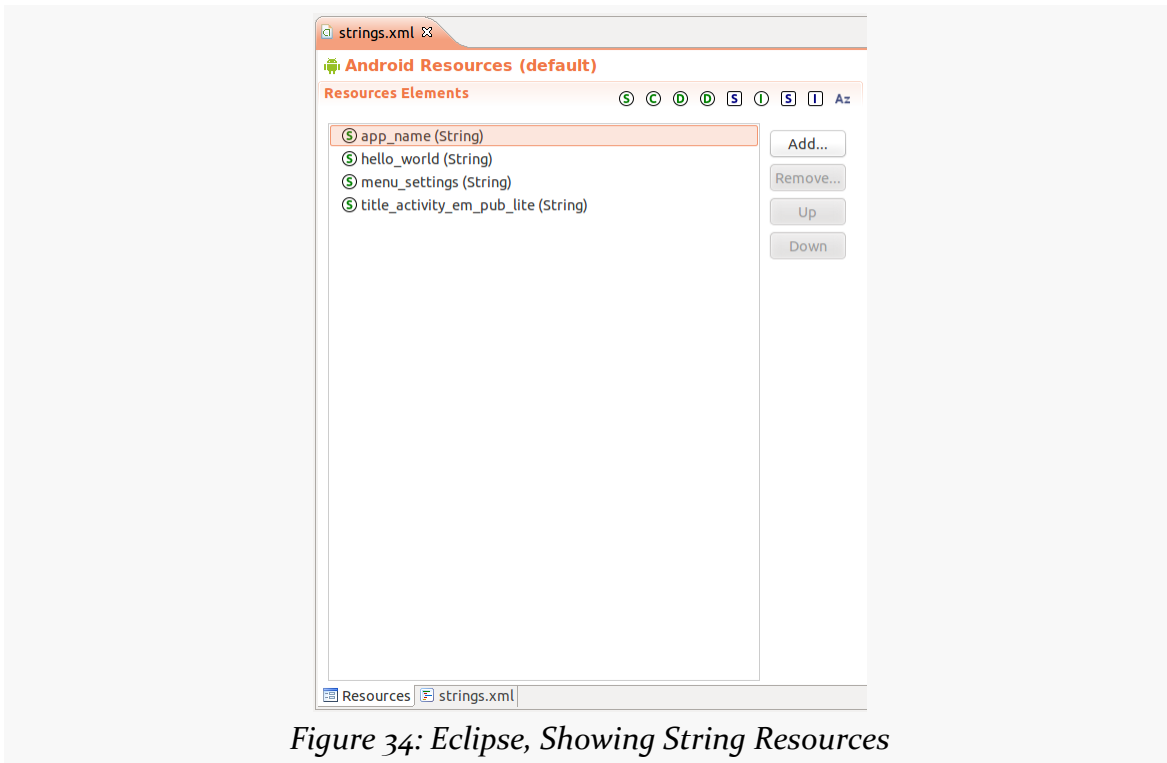


Figure 34: Eclipse, Showing String Resources

Clicking on an resource allows you to edit its name and value:

## SOME WORDS ABOUT RESOURCES

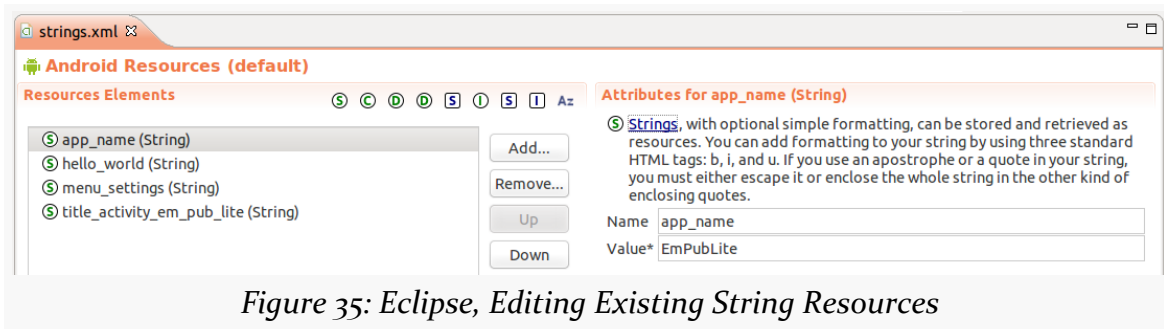


Figure 35: Eclipse, Editing Existing String Resources

Clicking the “Add...” button to the right of the list of strings brings up a dialog where you can add another resource to this file, typically a string:

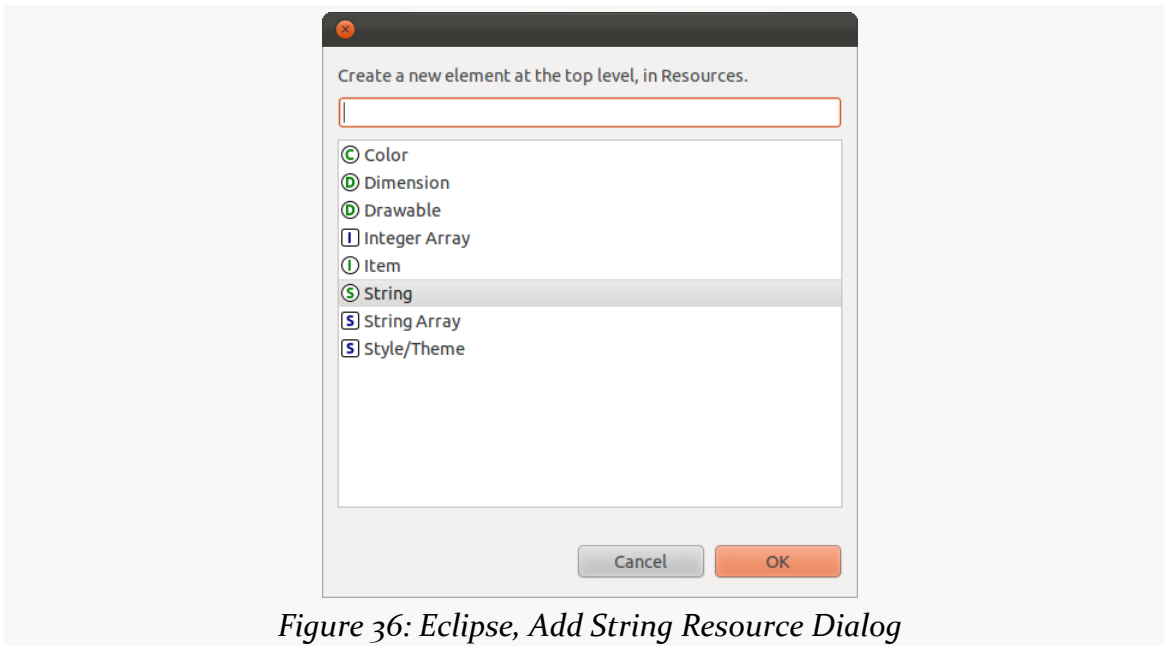


Figure 36: Eclipse, Add String Resource Dialog

Choosing “String” in that dialog and clicking OK will add another (empty) string resource to the list, where you can fill in the name and value.

You can always click on the `strings.xml` sub-tab to bring up an XML editor on the resources if you prefer.

## Got the Picture?

Android supports images in the PNG, JPEG, and GIF formats. GIF is officially discouraged, however; PNG is the overall preferred format. Android also supports

## SOME WORDS ABOUT RESOURCES

---

some proprietary XML-based image formats, though we will not discuss those at length until later in the book.

The default directory for these so-called drawable resources is `res/drawable/`. Any images found in there can be referenced from Java code or from other places (such as the manifest), regardless of device characteristics.

However, your stub project does not have a `res/drawable/` directory.

Instead, it has directories like `res/drawable-mdpi/` and `res/drawable-hdpi/`.

These refer to distinct resource sets. The suffixes (e.g., `-mdpi`, `-hdpi`) are filters, indicating under what circumstances the images stored in those directories should be used. Specifically, `-ldpi` indicates images that should be used on devices with low-density screens (around 120 dots-per-inch, or “dpi”). The `-mdpi` suffix indicates resources for medium-density screens (around 160dpi), `-hdpi` indicates resources for high-density screens (around 240dpi). `-xhdpi` indicates resources extra-high-density screens (around 320dpi), and so on.

Inside each of those directories, you will see an `ic_launcher.png` file (along with perhaps other icons). This is the stock icon that will be used for your application in the home screen launcher. Each of the images is of the same icon, but the higher-density icons have more pixels. The objective is for the image to be roughly the same physical size on every device, using higher densities to have more detailed images.

For example, our `EmPubLite` tutorial project has `res/drawable-hdpi/`, `res/drawable-xhdpi/`, `res/drawable-mdpi/`, and `res/drawable-ldpi/` directories, containing stock launcher icons (`ic_launcher.png`) for some of those densities (along with perhaps other icons).

Our `AndroidManifest.xml` file then references our `ic_launcher` icon:

```
<?xml version="1.0" encoding="utf-8"?>
<manifest xmlns:android="http://schemas.android.com/apk/res/android"
    package="com.commonware.empublite"
    android:versionCode="1"
    android:versionName="1.0">

    <uses-sdk
        android:minSdkVersion="9"
        android:targetSdkVersion="15"/>

    <supports-screens
        android:largeScreens="true"
```

## SOME WORDS ABOUT RESOURCES

---

```
    android:normalScreens="true"
    android:smallScreens="false"
    android:xlargeScreens="true"/>

<application
    android:allowBackup="true"
    android:icon="@drawable/ic_launcher"
    android:label="@string/app_name"
    android:theme="@style/AppTheme">
    <activity
        android:name="EmPubLiteActivity"
        android:label="@string/app_name">
        <intent-filter>
            <action android:name="android.intent.action.MAIN"/>

            <category android:name="android.intent.category.LAUNCHER"/>
        </intent-filter>
    </activity>
</application>

</manifest>
```

Note that the manifest simply refers to `@drawable/ic_launcher`, telling Android to find a drawable resource named `ic_launcher`. The resource reference does not indicate the file type of the resource — there is no `.png` in the resource identifier. This means you cannot have `ic_launcher.png` and `ic_launcher.jpg` in the same project, as they would both be identified by the same identifier. You will need to keep the “base name” (filename sans extension) distinct for all of your images.

Also, the `@drawable/ic_launcher` reference does not mention what screen density to use. That is because *Android* will choose the right screen density to use, based upon the device that is running your app. You do not have to worry about it explicitly, beyond having multiple copies of your icon.

If Android detects that the device has a screen density for which you lack an icon (e.g., an extra-high-density device with our stub project), Android will take the next-closest one and scale it. So, for our stub project, Android would take the `-hdpi` icon and scale it up to work on an `-xhdpi` display, such as that found on the Samsung Galaxy Nexus.

### Drawable Resources and Eclipse

Eclipse does not ship with any sort of image editor that you could use for PNG and JPEG files. Hence, you will find yourself editing these images using other tools outside of Eclipse. Double-clicking on an image in the Package Explorer in Eclipse should bring up your default editor for that file type.

## Dimensions

Dimensions are used in several places in Android to describe distances, such as a widget's size. There are several different units of measurement available to you:

1. px means hardware pixels, whose size will vary by device, since not all devices have the same “screen density” (the ~4” Galaxy Nexus and the ~10” Motorola XOOM have almost the same number of pixels in vastly different sizes)
2. in and mm for inches and millimeters, respectively, based on the actual size of the screen
3. pt for points, which in publishing terms is 1/72nd of an inch (again, based on the actual physical size of the screen)
4. dip for device-independent pixels — one dip equals one hardware pixel for a ~160dpi resolution screen, but one dip equals two hardware pixels on a ~320dpi screen

Dimension resources, by default, are held in a `dimens.xml` file in the `res/values/` directory that also holds your strings.

To encode a dimension as a resource, add a `dimen` element to `dimens.xml`, with a `name` attribute for your unique name for this resource, and a single child text element representing the value:

```
<resources>
  <dimen name="thin">10dip</dimen>
  <dimen name="fat">1in</dimen>
</resources>
```

In a layout, you can reference dimensions as `@dimen/...`, where the ellipsis is a placeholder for your unique name for the resource (e.g., `thin` and `fat` from the sample above). In Java, you reference dimension resources by the unique name prefixed with `R.dimen.` (e.g., `Resources.getDimen(R.dimen.thin)`).

While our stub project does not use dimension resources, we will be seeing them soon enough.

## Dimension Resources and Eclipse

Much like editing string resources, when you double-click on a dimension resource file (e.g., `res/values/dimens.xml`), you will be presented with a list of existing dimensions. Clicking on one will let you change its definition:

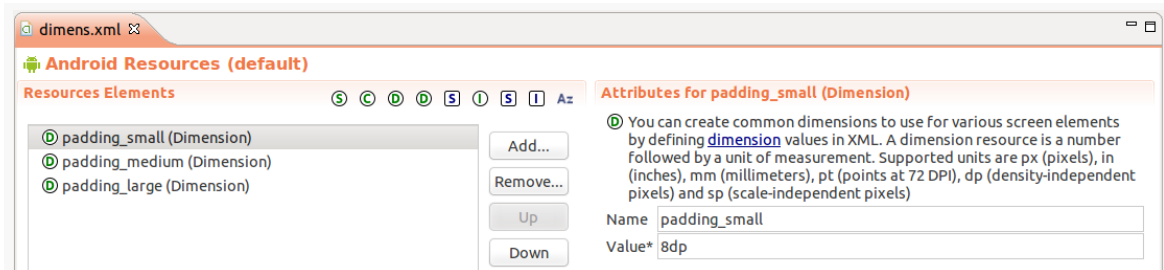


Figure 37: Eclipse, Editing Existing Dimension Resources

Clicking the “Add...” button to the right of the list of dimensions brings up a dialog where you can add another resource to this file, typically a dimension. Choosing “Dimension” and clicking “OK” will add an empty dimension resource to the file, for which you can supply the name and value.

And, as always, you can click on a sub-tab with the name of your file (e.g., `dimens.xml`) to bring up an XML editor on your resources:

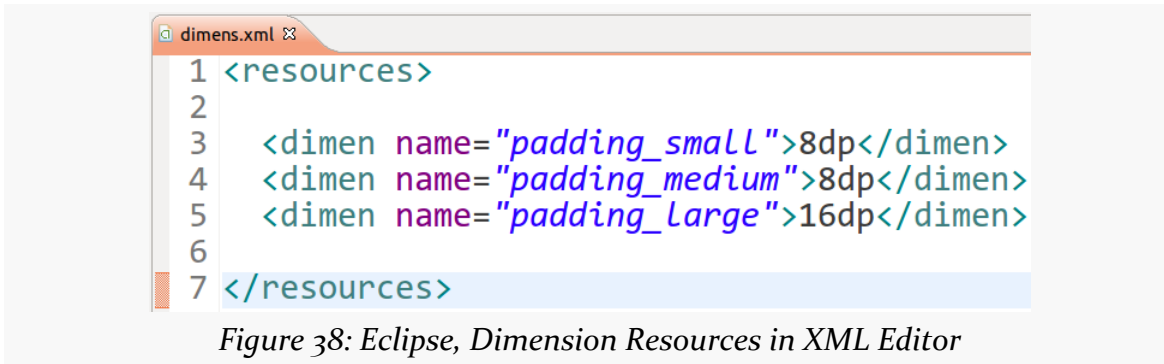


Figure 38: Eclipse, Dimension Resources in XML Editor

## The Resource That Shall Not Be Named... Yet

Your stub project also has a `res/layout/` directory, in addition to the ones described above. That is for UI layouts, describing what your user interface should look like. We will get into the details of that type of resource as we start examining our user interfaces in [an upcoming chapter](#).





# **Tutorial #4 - Adjusting Our Resources**

Our EmPubLite project has some initial resources, put there by the Android build tools when we created the project. However, the defaults are not what we want for the long term. So, in addition to adding new resources in future tutorials, we will fix the ones we already have in this tutorial.

This is a continuation of the work we did in [the previous tutorial](#).

You can find [the results of the previous tutorial](#) and [the results of this tutorial](#) in [the book's GitHub repository](#).

## **Step #1: Changing the Name**

Our application shows up everywhere as “EmPubLite”:

- In the title bar of our activity
- As the caption under our icon in the home screen launcher
- In the Application list in the Settings app
- And so on

We should change that to be “EmPub Lite”, adding a space for easier reading, and to illustrate that this is a “lite” version of the full EmPub application.

If you wish to make this change using Eclipse's wizards and tools, follow the instructions in the “Eclipse” section below. Otherwise, follow the instructions in the “Outside of Eclipse” section (appears after the “Eclipse” section).

## TUTORIAL #4 - ADJUSTING OUR RESOURCES

---

### Eclipse

In the Package Explorer, open up the `res/values/` folder — you should see a `strings.xml` file in there:

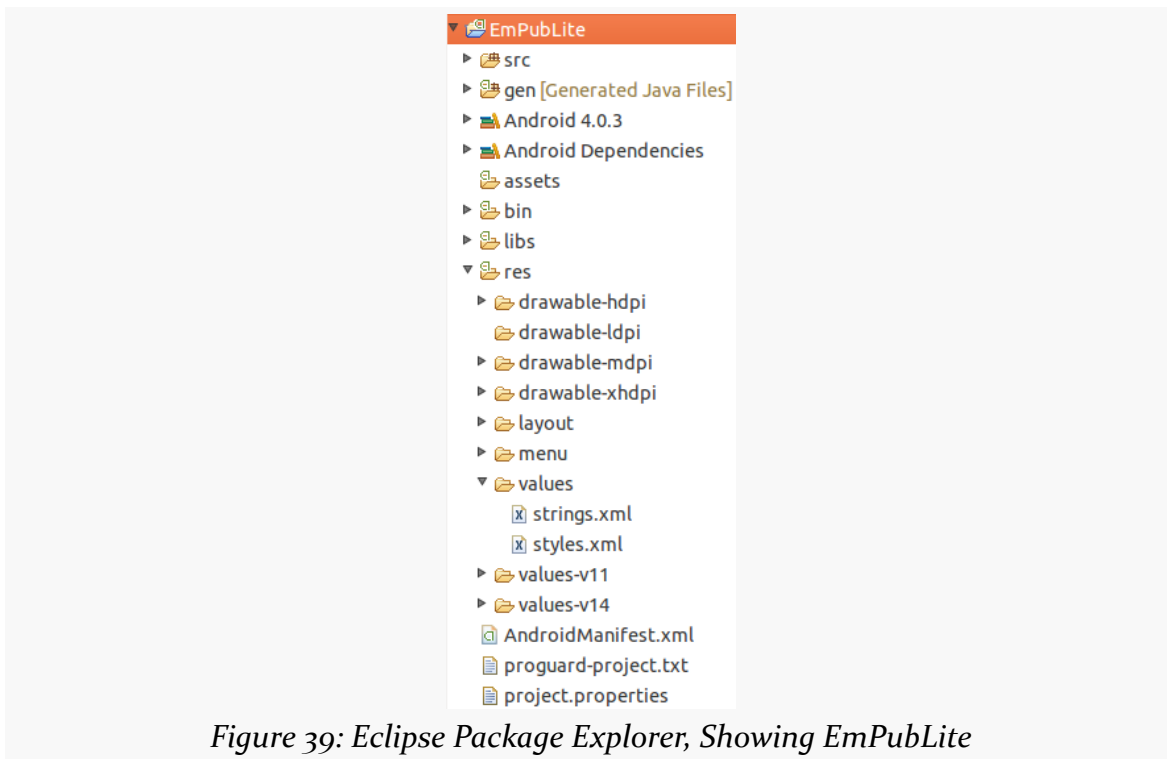


Figure 39: Eclipse Package Explorer, Showing EmPubLite

Double-click on `strings.xml` to open it in the string resources editor:

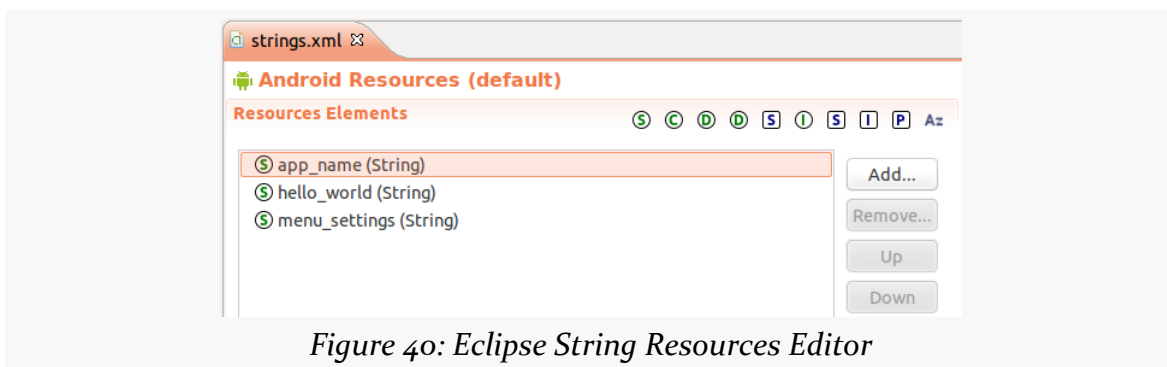


Figure 40: Eclipse String Resources Editor

This shows a list of the defined string resources (denoted by the green S in the circle) in this file.

## TUTORIAL #4 - ADJUSTING OUR RESOURCES

---

Click the `app_name` resource, to bring up its details on the right:

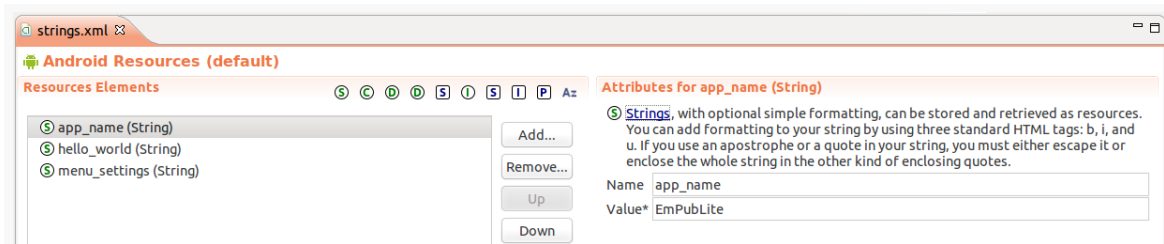


Figure 41: Eclipse String Resources Editor with Details

The `app_name` name for the resource is fine, as that is how this string is referenced from the manifest. Change the value to be “EmPub Lite” (adding the space).

### Outside of Eclipse

Open up `res/values/strings.xml` in your favorite editor. You will find an element that looks like:

```
<string name="app_name">EmPubLite</string>
```

Change the text node in this element to `EmPub Lite`. Repeat the process for the `title_activity_em_pub_lite` resource. Then save your changes, giving you:

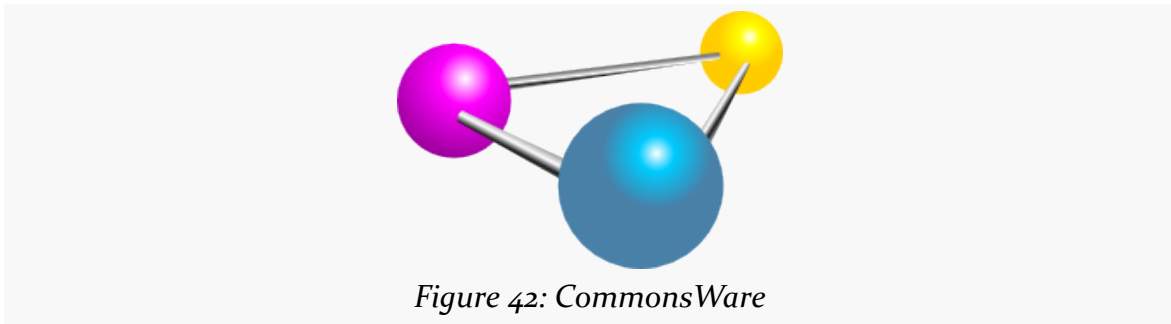
```
<resources>
  <string name="app_name">EmPub Lite</string>
  <string name="hello_world">Hello world!</string>
  <string name="menu_settings">Settings</string>
</resources>
```

### Step #2: Changing the Icon

The build tools provide us with a stock icon to use for the launcher — the actual image used varies by Android tools release. However, we can change it to something else. For example, we could use the icon portion of the CommonsWare logo:

## TUTORIAL #4 - ADJUSTING OUR RESOURCES

---

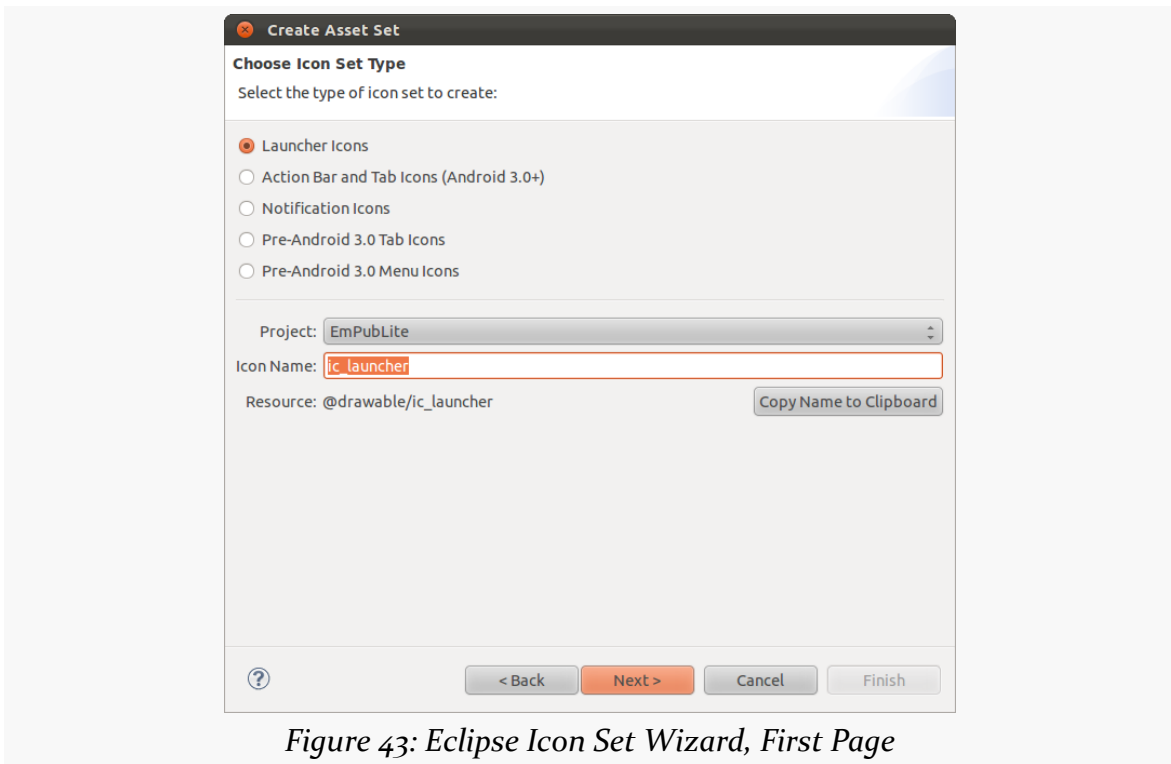


First, [download the original image](#) and save it somewhere on your development machine.

Then, follow the instructions for Eclipse or non-Eclipse users below.

### Eclipse

From the Eclipse main menu, choose File > New > Other > Android. In the resulting dialog, choose “Android Icon Set” and press Next.



## TUTORIAL #4 - ADJUSTING OUR RESOURCES

---

The defaults on the first page of the icon set wizard are to create launcher icons, with a file base name of `ic_launcher`, to be added to the EmPubLite project. If the values that you see in the wizard do not match that, adjust the wizard, then press Next.

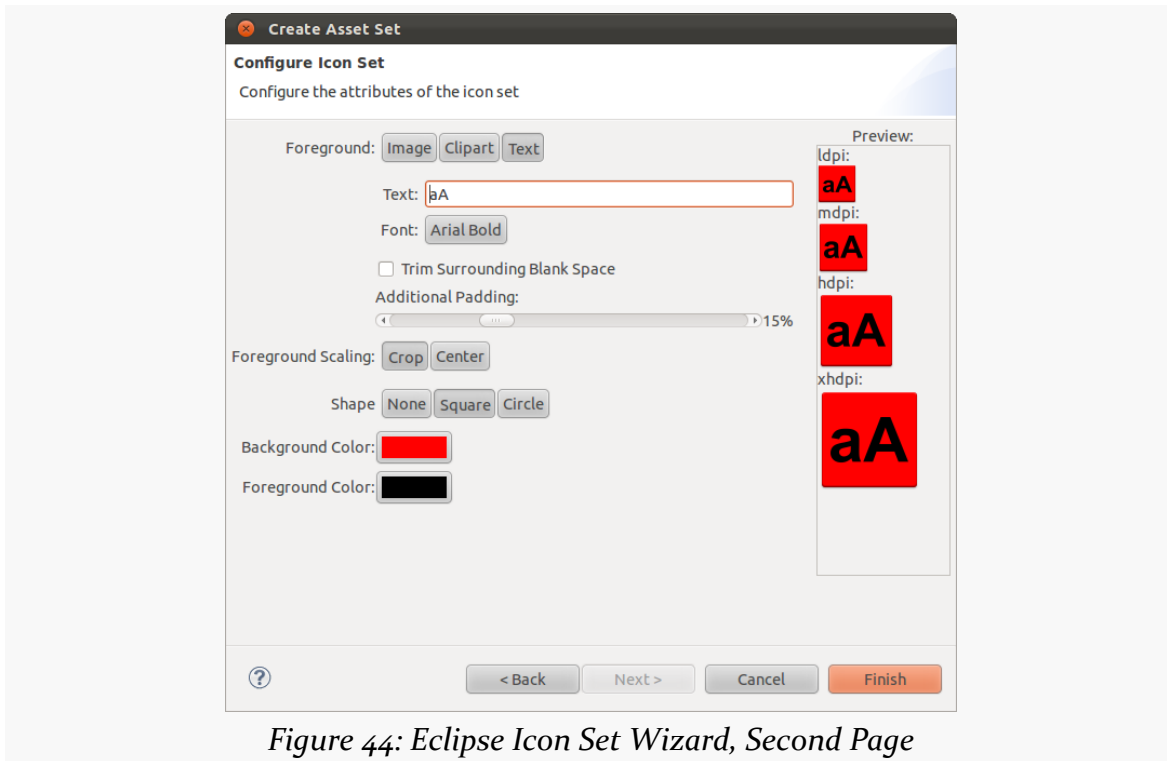


Figure 44: Eclipse Icon Set Wizard, Second Page

In the second page of the icon set wizard, click the “Image” button in the “Foreground” row. This will change the wizard slightly, giving you a space to supply the path to some image:

## TUTORIAL #4 - ADJUSTING OUR RESOURCES

---

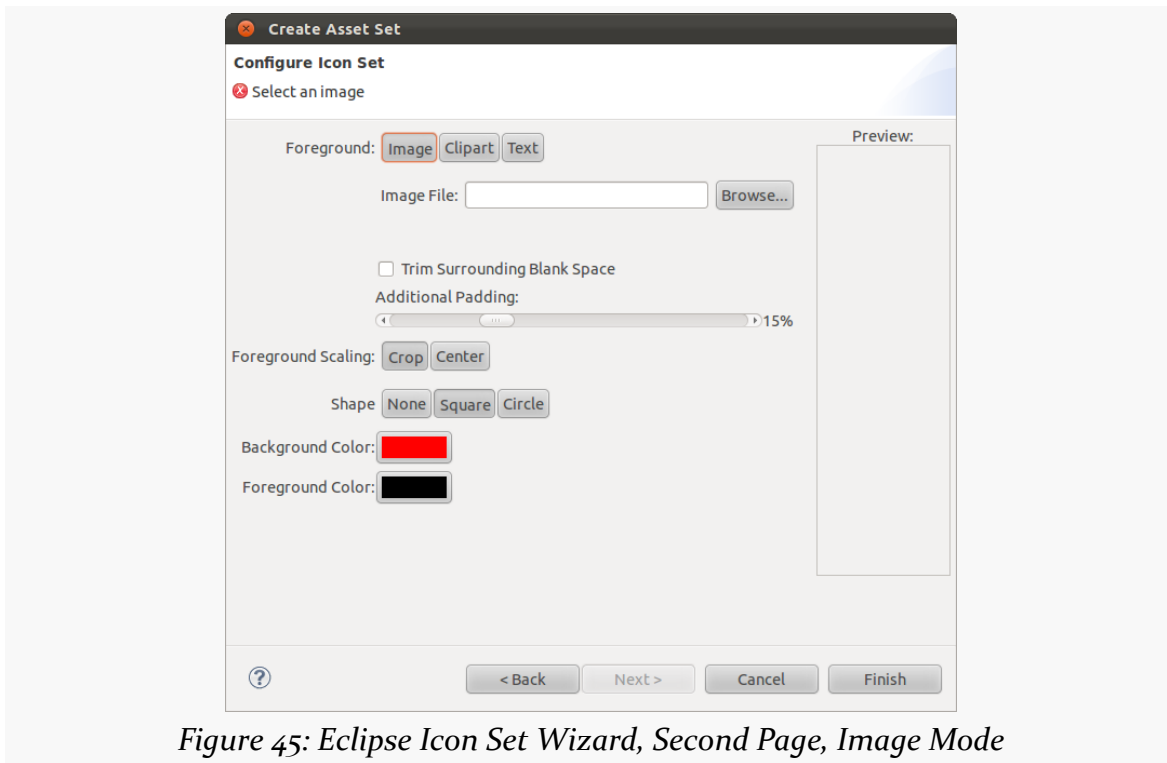


Figure 45: Eclipse Icon Set Wizard, Second Page, Image Mode

Click the “Browse...” button and open the `molecule.png` file you downloaded above. That will display the results in the wizard:

## TUTORIAL #4 - ADJUSTING OUR RESOURCES



Click the “None” button in the “Shape” row, to remove the square background. Then, click Finish. You will be prompted for whether you want to overwrite the existing images — click “Yes to All”.

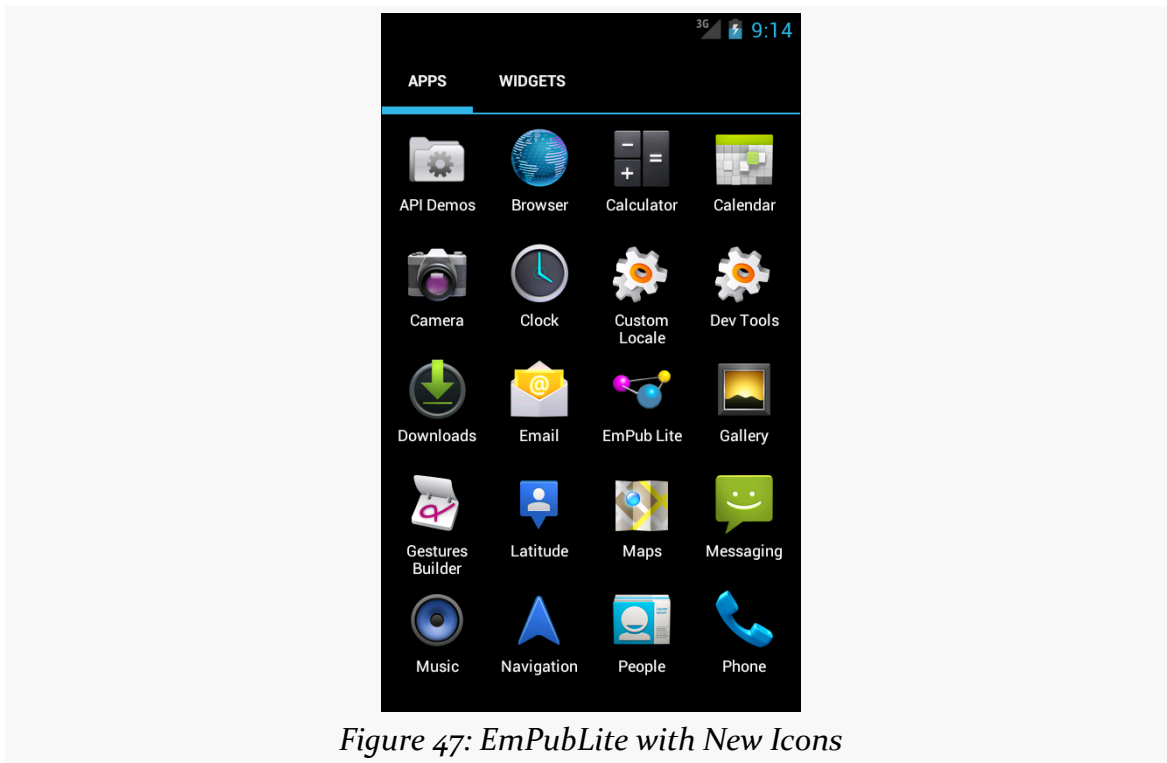
You may wind up with a bunch of error markers on your project for all of the new images in the Package Explorer. If this occurs, choose Project > Clean from the Eclipse main menu, ensure that EmPubLite is checked in the project list, and choose OK. This should get rid of those error markers.

If you run the resulting app, you will see that it shows up with the new name and icon, such as in the launcher:



## TUTORIAL #4 - ADJUSTING OUR RESOURCES

---



*Figure 47: EmPubLite with New Icons*

### Outside of Eclipse

We can use the [Android Asset Studio](#) to create launcher icons out of this image, if you have the Chrome browser.

Visit the [Android Asset Studio](#) Web site in Chrome. Then, click the “Launcher icons” link in the “Icon generators” portion of the home page.

## TUTORIAL #4 - ADJUSTING OUR RESOURCES

---

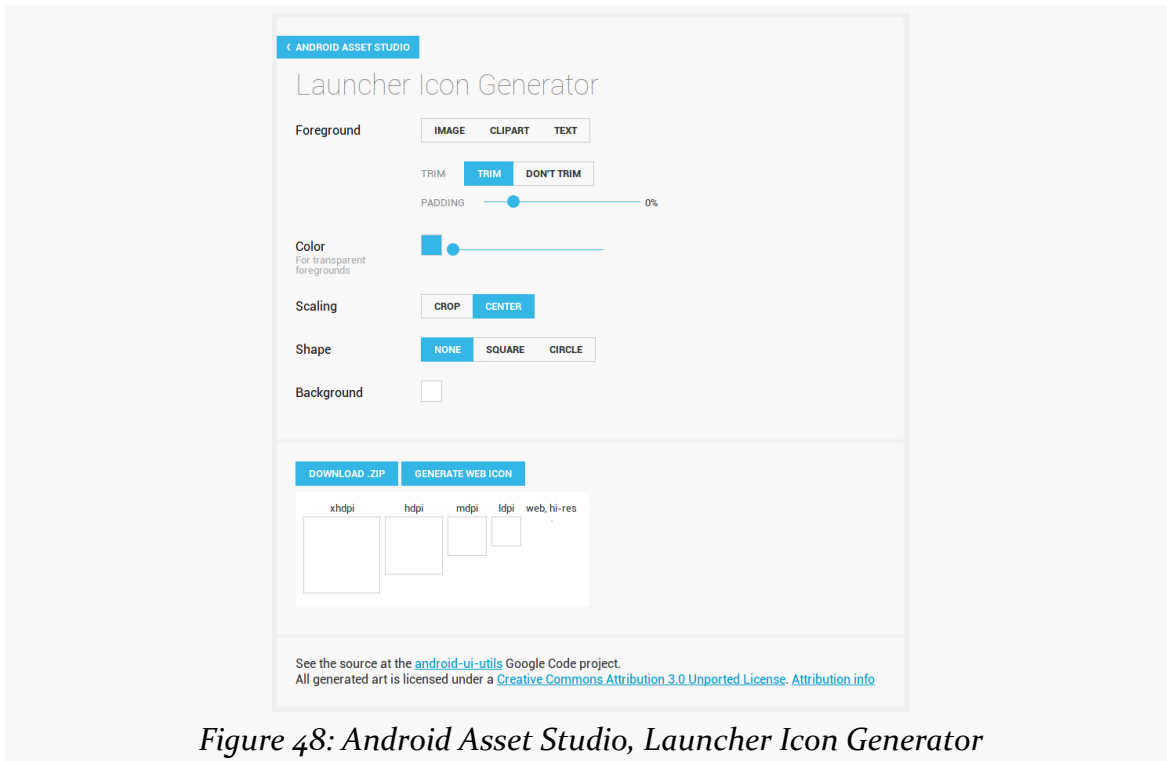


Figure 48: Android Asset Studio, Launcher Icon Generator

Click on the “Image” button in the “Foreground” row. This will bring up a “file open” dialog — find and open the `molecule.png` file you downloaded previously. Automatically, the Studio will generate the icons we need:

## TUTORIAL #4 - ADJUSTING OUR RESOURCES

---

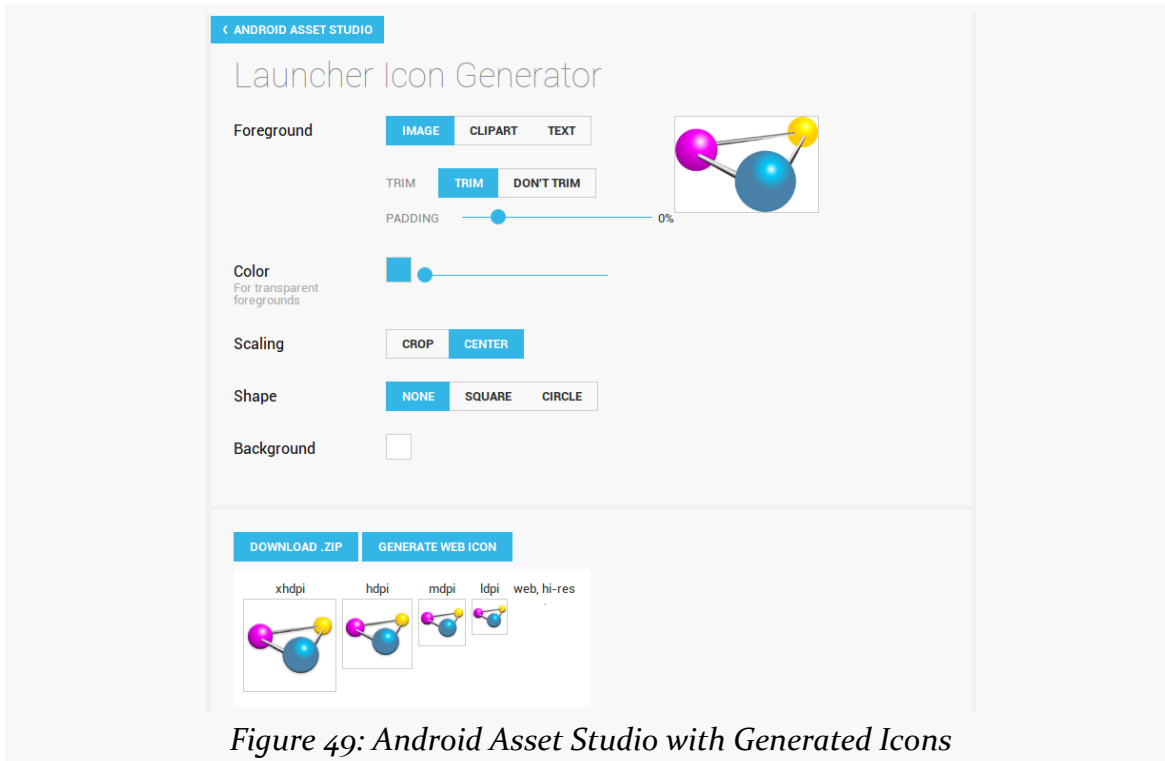


Figure 49: Android Asset Studio with Generated Icons

Click the “Download .ZIP” button to download a ZIP archive file containing all the generated icons.

If you are having difficulty using the Android Asset Studio, you can [download the icons](#) directly.

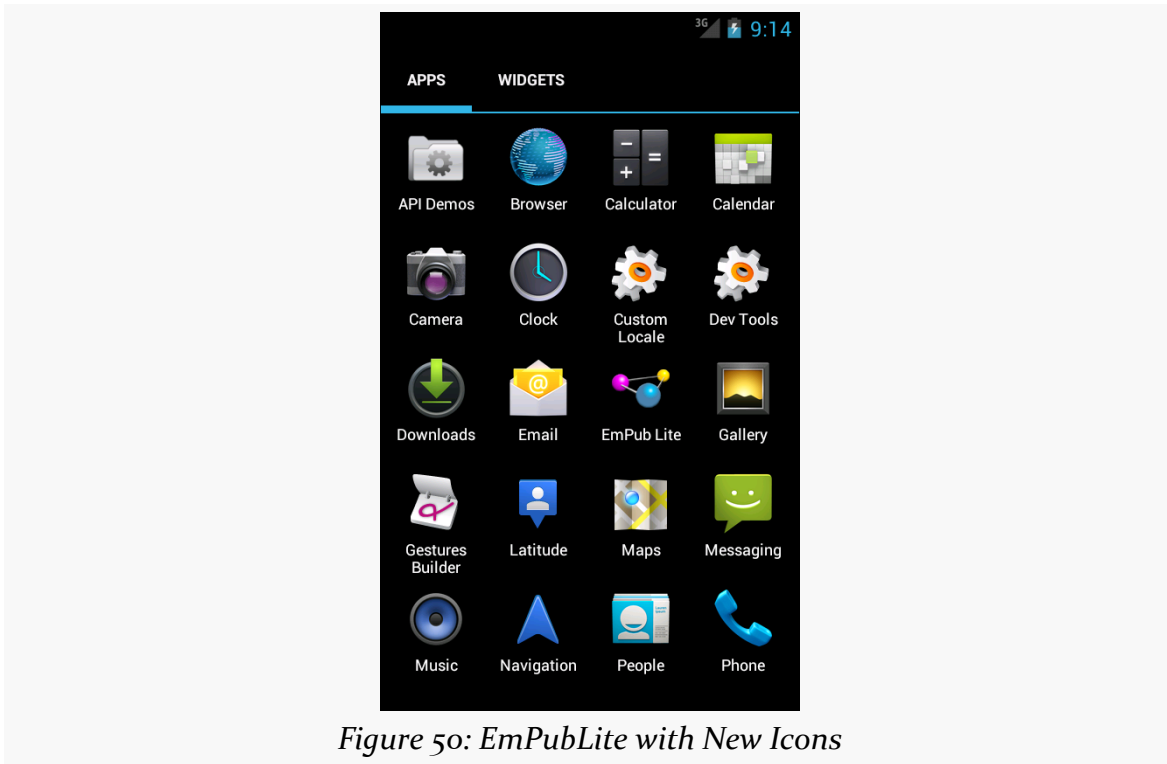
If you examine that ZIP file, you will see that it contains a `res/` directory with a series of `drawable` subdirectories, each containing a copy of `ic_launcher.png` for a given screen density. The ZIP file also contains a high-resolution image that we might use if we planned on uploading this app to Google Play, but we will not need that for the tutorials.

Copy the four `ic_launcher.png` files from the ZIP archive’s directories into the corresponding directories in your project. You may have to copy the whole `drawable-xhdpi/` directory, as that may not already exist in your project. If you are using Eclipse, you can drag-and-drop into the Package Explorer directly. If you prefer, you can drag-and-drop into the project as found on your development machine’s file system, but then you will need to press `<F5>` on your project in Eclipse to get it to reflect the changes you made behind Eclipse’s back.

## TUTORIAL #4 - ADJUSTING OUR RESOURCES

---

If you run the resulting app, you will see that it shows up with the new name and icon, such as in the launcher:



*Figure 50: EmPubLite with New Icons*

## In Our Next Episode...

... we will [add a progress indicator](#) to the UI of our tutorial project.



# The Theory of Widgets

---

There is a decent chance that you have already done work with widget-based UI frameworks. In that case, much of this chapter will be review, though checking out the section on the [absolute positioning anti-pattern](#) should certainly be worthwhile.

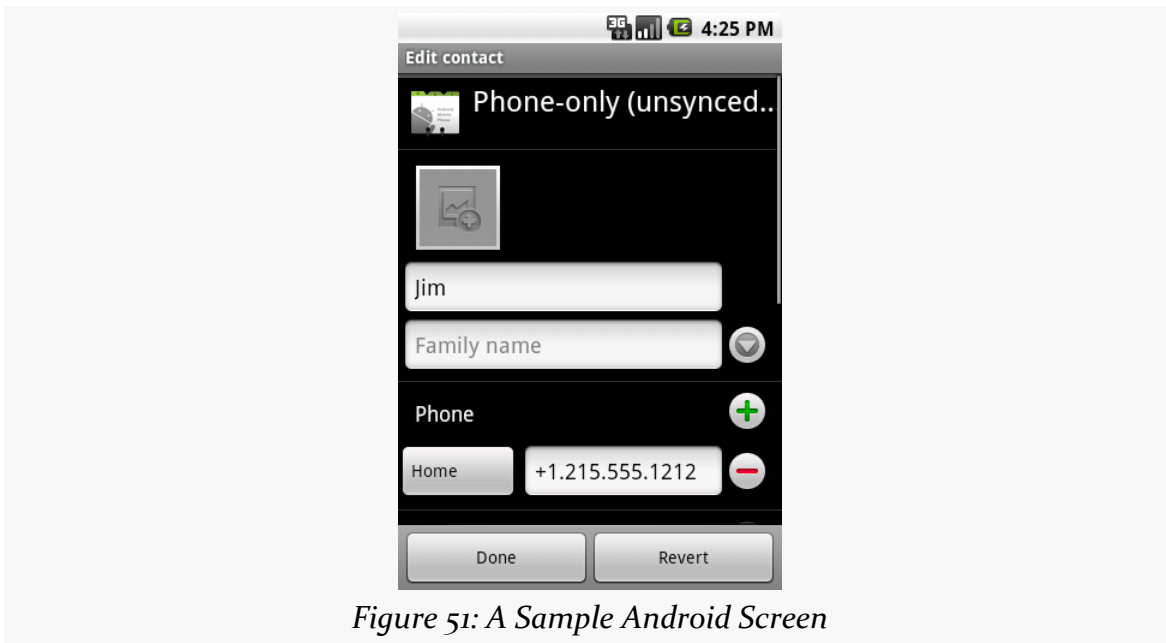
There is a chance, though, that your UI background has come from places where you have not been using a traditional widget framework, where either you have been doing all of the drawing yourself (e.g., game frameworks) or where the UI is defined more in the form of a document (e.g., classic Web development). This chapter is aimed at you, to give you some idea of what we are talking about when discussing the notion of widgets and containers.

## What Are Widgets?

Wikipedia has [a nice definition of a widget](#):

In computer programming, a widget (or control) is an element of a graphical user interface (GUI) that displays an information arrangement changeable by the user, such as a window or a text box. The defining characteristic of a widget is to provide a single interaction point for the direct manipulation of a given kind of data. In other words, widgets are basic visual building blocks which, combined in an application, hold all the data processed by the application and the available interactions on this data.

Take, for example, this Android screen:



*Figure 51: A Sample Android Screen*

Ignoring the gray horizontal bars across the top of this screen, we see:

- an icon of a contact “Rolodex” card
- some text (“Phone-only (unsynced..)”)
- a thin horizontal divider line
- another icon, showing a placeholder for a contact photo, in a frame
- two data entry fields
- an icon that looks like a downward-pointing arrowhead in a circle
- another thin horizontal divider line
- another piece of text (“Phone”)
- two more icons, that look like plus and minus signs in circles
- a button (“Home”)
- another data entry field
- two more buttons (“Done” and “Revert”) in some sort of bar across the bottom

Everything listed above is a widget. The user interface for most Android screens (“activities”) is made up of one or more widgets.

This does not mean that you cannot do your own drawing. In fact, all the existing widgets are implemented via low-level drawing routines, which you can use for everything from your own custom widgets to games.

This also does not mean that you cannot use Web technologies. In fact, we will see later in this book [a widget designed to allow you to embed Web content](#) into an Android activity.

However, for most non-game applications, your Android user interface will be made up of several widgets.

## Size, Margins, and Padding

Widgets have some sort of size, since a zero-pixel-high, zero-pixel-wide widget is not especially user-friendly. Sometimes, that size will be dictated by what is inside the widget itself, such as a label (`TextView`) having a size dictated by the text in the label. Sometimes, that size will be dictated by the size of whatever holds the widget (a “container”, described in the next section), where the widget wants to take up all remaining width and/or height. Sometimes, that size will be a specific set of dimensions.

Widgets can have margins. As with CSS, margins provide separation between a widget and anything adjacent to it (e.g., other widgets, edges of the screen). Margins are really designed to help prevent widgets from running right up next to each other, so they are visually distinct. Some developers, however, try to use margins as a way to hack “absolute positioning” into Android, which is an anti-pattern that we will examine [later in this chapter](#).

Widgets can have padding. As with CSS, padding provides separation between the contents of a widget and the widget’s edges. This is mostly used with widgets that have some sort of background, like a button, so that the contents of the widget (e.g., button caption) does not run right into the edges of the button, once again for visual distinction.

## What Are Containers?

Containers are ways of organizing multiple widgets into some sort of structure. Widgets do not naturally line themselves up in some specific pattern — we have to define that pattern ourselves.

In most GUI toolkits, a container is deemed to have a set of children. Those children are widgets, or sometimes other containers. Each container has its basic rule for how it lays out its children on the screen, possibly customized by requests from the children themselves.



Common container patterns include:

- put all children in a row, one after the next
- put all children in a column, one below the next
- arrange the children into a table or grid with some number of rows and columns
- anchor the children to the sides of the container, according to requests made by those children
- anchor the children to other children in the container, according to requests made by those children
- stack all children, one on top of the next
- and so on

In the sample activity above, the dominant pattern is a column, with things laid out from top to bottom. Some of those things are rows, with contents laid out left to right. However, as it turns out, the area with most of those widgets is scrollable — you can see a thin scrollbar on the right side of the screen. The “Done” and “Revert” buttons, along with the scrollable container, are themselves anchored to sides of their parent container (e.g., the “Done”/“Revert” bar is anchored to the bottom).

Android supplies a handful of containers, designed to handle most common scenarios, including everything in the list above. You are also welcome to create your own custom containers, to implement business rules that are not directly supported by the existing containers.

Note that containers also have size, padding, and margins, just as widgets do.

## The Absolute Positioning Anti-Pattern

You might wonder why all of these containers and such are necessary. After all, can't you just say that such-and-so widget goes at this pixel coordinate, and this other widget goes at that pixel coordinate, and so on?

Many developers have taken that approach — known as absolute positioning — over the years, to their eventual regret.

For example, many of you may have used Windows apps, back in the 1990's, where when you would resize the application window, the app would not really react all that much. You would expand the window, and the UI would not change, except to have big empty areas to the right and bottom of the window. This is because the

## THE THEORY OF WIDGETS

---

developers simply said that such-and-so widget goes at this pixel coordinate, and this other widget goes at that pixel coordinate, **regardless of the actual window size**.

In modern Web development, you see this in the debate over [fixed versus fluid Web design](#). The consensus seems to be that fluid designs are better, though frequently they are more difficult to set up. Fluid Web designs can better handle differing browser window sizes, whether those window sizes are because the user resized their browser window manually, or because those window sizes are dictated by the screen resolution of the device viewing the Web page. Fixed Web designs — effectively saying that such-and-so element goes at such-and-so pixel coordinate and so on — tend to be easier to build but adapt more poorly to differing browser window sizes.

In mobile, particularly with Android, we have a wide range of possible screen resolutions, from QVGA (320x240) to beyond 1080p (1920x1080), and many values in between. Moreover, any device manufacturer is welcome to create a device with whatever resolution they so desire – there are no rules limiting manufacturers to certain resolutions. Hence, as developers, having the Android equivalent of fluid Web designs is critical, and the way you will accomplish that is by sensible use of containers, avoiding absolute positioning. The containers (and, to a lesser extent, the widgets) will determine how extra space is employed, as the screens get larger and larger.



# The Android User Interface

---

The project you created in [an earlier tutorial](#) was just the default files generated by the Android build tools — you did not write any Java code yourself. In this chapter, we will examine the basic Java code and resources that makes up an Android activity.

## The Activity

An Android project's `src/` directory contains the standard Java-style tree of directories based upon the Java package you chose when you created the project (e.g., `com.commonware.android` results in `src/com/commonware/android/`). If you checked the checkbox in the Eclipse new-project wizard to create an activity — or if you used the command-line tools to create your project — you will have, in the innermost directory, a Java source file representing an activity class.

For the stub project we created earlier in this book, that sample class looks like this:

```
package com.commonware.empublite;

import android.os.Bundle;
import android.app.Activity;
import android.view.Menu;

public class EmPubLiteActivity extends Activity {

    @Override
    protected void onCreate(Bundle savedInstanceState) {
        super.onCreate(savedInstanceState);
        setContentView(R.layout.main);
    }

    @Override
    public boolean onCreateOptionsMenu(Menu menu) {
        // Inflate the menu; this adds items to the action bar
    }
}
```

```
// if it is present.  
getMenuInflater().inflate(R.menu.activity_main, menu);  
return true;  
}  
}
```

## Dissecting the Activity

Let's examine this Java code piece by piece:

```
package com.commonware.empublite;  
  
import android.os.Bundle;  
import android.app.Activity;  
import android.view.Menu;
```

The package declaration needs to be the same as the one you used when creating the project. And, like any other Java project, you need to import any classes you reference. Most of the Android-specific classes are in the `android` package.

Remember that not every Java SE class is available to Android programs! Visit the [Android class reference](#) to see what is and is not available.

```
public class EmPubLiteActivity extends Activity {
```

Activities are public classes, inheriting from the `android.app.Activity` base class (or, possibly, from some other class that itself inherits from `Activity`). You can have whatever data members you decide that you need, though the initial code has none.

```
@Override  
protected void onCreate(Bundle savedInstanceState) {  
    super.onCreate(savedInstanceState);  
    setContentView(R.layout.main);  
}
```

The `onCreate()` method is invoked when the activity is started. We will discuss the `Bundle` parameter to `onCreate()` [in a later chapter](#). For the moment, consider it an opaque handle that all activities receive upon creation.

The first thing you should do in `onCreate()` is chain upward to the superclass, so the stock Android activity initialization can be done. The only other statement in our stub project's `onCreate()` is a call to `setContentView()`. This is where we tell Android what the user interface is supposed to be for our activity.

This raises the question: what does `R.layout.main` mean? Where did this `R` come from?

To explain that, we need to start thinking about layout resources and how resources are referenced from within Java code. We will get to that momentarily.

```
@Override
public boolean onCreateOptionsMenu(Menu menu) {
    // Inflate the menu; this adds items to the action bar
    // if it is present.
    getMenuInflater().inflate(R.menu.activity_main, menu);
    return true;
}
```

The `onCreateOptionsMenu()` is used in Android to populate the action bar, or the options menu on older devices. We will discuss the action bar [in an upcoming chapter](#). For now, just ignore this method.

Now, back to this mysterious `R`...

## Using XML-Based Layouts

As noted earlier, Android uses a series of widgets and containers to describe your typical user interface. These all inherit from an `android.view.View` base class, for things that can be rendered into a standard widget-based activity.

While it is technically possible to create and attach widgets and containers to our activity purely through Java code, the more common approach is to use an XML-based layout file. Dynamic instantiation of widgets is reserved for more complicated scenarios, where the widgets are not known at compile-time (e.g., populating a column of radio buttons based on data retrieved off the Internet).

With that in mind, it's time to break out the XML and learn how to lay out Android activity contents that way.

### What Is an XML-Based Layout?

As the name suggests, an XML-based layout is a specification of widgets' relationships to each other — and to containers — encoded in XML format. Specifically, Android considers XML-based layouts to be resources, and as such layout files are stored in the `res/layout/` directory inside your Android project (or,

as we will see later, other layout resource sets, like `res/layout-land/` for layouts to use when the device is held in landscape).

Each XML file contains a tree of elements specifying a layout of widgets and containers that make up one `View`. The attributes of the XML elements are properties, describing how a widget should look or how a container should behave. For example, if a `Button` element has an attribute value of `android:textStyle = "bold"`, that means that the text appearing on the face of the button should be rendered in a boldface font style.

For example, here is the `res/layout/main.xml` file that came with our stub project:

```
<RelativeLayout xmlns:android="http://schemas.android.com/apk/res/android"
    xmlns:tools="http://schemas.android.com/tools"
    android:layout_width="match_parent"
    android:layout_height="match_parent"
    tools:context=".EmPubLiteActivity">

    <TextView
        android:layout_width="wrap_content"
        android:layout_height="wrap_content"
        android:layout_centerHorizontal="true"
        android:layout_centerVertical="true"
        android:text="@string/hello_world"/>

</RelativeLayout>
```

The class name of a widget or container — such as `RelativeLayout` or `TextView` — forms the name of the XML element. Since `TextView` is an Android-supplied widget, we can just use the bare class name. If you create your own widgets as subclasses of `android.view.View`, you would need to provide a full package declaration as well (e.g., `com.commonsware.android.MyWidget`).

The root element needs to declare the Android XML namespace (`xmlns:android="http://schemas.android.com/apk/res/android"`). All other elements will be children of the root and will inherit that namespace declaration.

The attributes are properties of the widget or container, describing what it should look and work like. For example, the `android:layout_centerHorizontal="true"` attribute on the `TextView` element indicates that the `TextView` should be centered within its `RelativeLayout` parent.

We will get into details about these attributes, their possible values, and their uses, in upcoming chapters. Note that those attributes in the `tools` namespace (e.g.,

---

## THE ANDROID USER INTERFACE

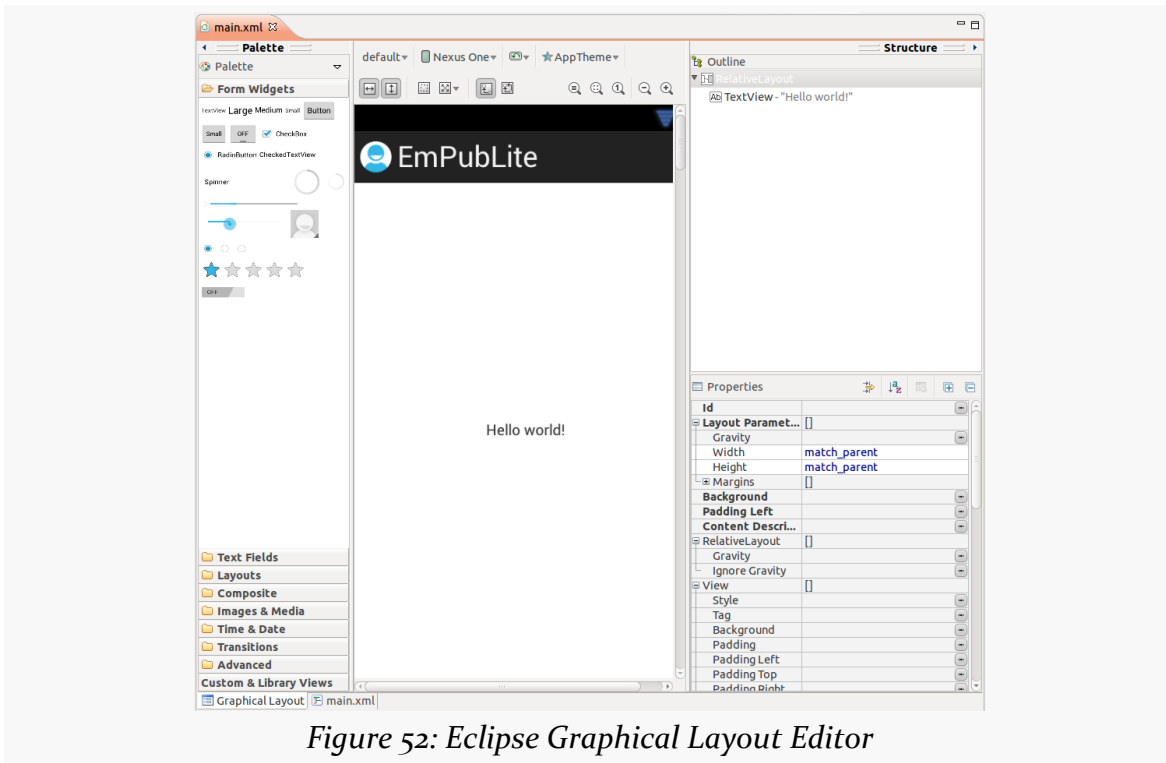
---

tools:context) are there solely to support the Android build tools, Eclipse in particular, and do not affect the runtime execution of your project.

Android's SDK ships with a tool (aapt) which uses the layouts. This tool should be automatically invoked by your Android tool chain (e.g., Eclipse, Ant's build.xml). Of particular importance to you as a developer is that aapt generates an R.java source file within your project's gen/ directory, allowing you to access layouts and widgets within those layouts directly from your Java code. In other words, this is where that magic R value used in setContentView() comes from. We will discuss that a bit more [later in this chapter](#).

### XML Layouts and Eclipse

If you are using Eclipse, and you double-click on the res/layout/main.xml file in your project, you will not initially see that XML. Instead, you will be taken to the graphical layout editor:



*Figure 52: Eclipse Graphical Layout Editor*

The “main.xml” sub-tab will show you the raw XML. The default “Graphical Layout” sub-tab, though, shows you a preview of what your layout would look like, if it were to be used for an activity. The “Palette” on the left shows all sorts of widgets and



containers, which you can drag into the preview area to add an instance of your chosen widget or container to your layout. Right-clicking over a widget or container will give you an extensive context menu to configure the item, and the toolbar immediately above the preview area will let you configure common properties of a selected widget or container.

We will go into much more detail about using the graphical layout editor in [an upcoming chapter](#), as we start to work more with specific widgets and containers.

### Why Use XML-Based Layouts?

Almost everything you do using XML layout files can be achieved through Java code. For example, you could use `setText()` to have a button display a certain caption, instead of using a property in an XML layout. Since XML layouts are yet another file for you to keep track of, we need good reasons for using such files.

Perhaps the biggest reason is to assist in the creation of tools for view definition, such as the aforementioned graphical layout editor in Eclipse. Such GUI builders could, in principle, generate Java code instead of XML. The challenge is re-reading the definition in to support edits — that is far simpler if the data is in a structured format like XML than in a programming language. Moreover, keeping the generated bits separated out from hand-written code makes it less likely that somebody's custom-crafted source will get clobbered by accident when the generated bits get re-generated. XML forms a nice middle ground between something that is easy for tool-writers to use and easy for programmers to work with by hand as needed.

Also, XML as a GUI definition format is becoming more commonplace. Microsoft's [XAML](#), Adobe's [Flex](#), Google's [GWT](#), and Mozilla's [XUL](#) all take a similar approach to that of Android: put layout details in an XML file and put programming smarts in source files (e.g., JavaScript for XUL). Many less-well-known GUI frameworks, such as [ZK](#), also use XML for view definition. While “following the herd” is not necessarily the best policy, it does have the advantage of helping to ease the transition into Android from any other XML-centered view description language.

### Using Layouts from Java

Given that you have painstakingly set up the widgets and containers for your view in an XML layout file named `main.xml` stored in `res/layout/`, all you need is one statement in your activity's `onCreate()` callback to use that layout, as we saw in our stub project's activity:

## THE ANDROID USER INTERFACE

---

```
setContentView(R.layout.main);
```

Here, `R.layout.main` tells Android to load in the layout (layout) resource (R) named `main.xml` (main).



# Basic Widgets

---

Every GUI toolkit has some basic widgets: fields, labels, buttons, etc. Android's toolkit is no different in scope, and the basic widgets will provide a good introduction as to how widgets work in Android activities. We will examine a number of these in this chapter.

## Common Concepts

There are a few core features of widgets that we need to discuss at the outset, before we dive into details on specific types of widgets.

### Widgets and Attributes

As mentioned in [a previous chapter](#), widgets have attributes that describe how they should behave. In an XML layout file, these are literally XML attributes on the widget's element in the file. Usually, there are corresponding getter and setter methods for manipulating this attribute at runtime from your Java code.

If you visit the JavaDocs for a widget, such as [the JavaDocs for TextView](#), you will see an “XML Attributes” table near the top. This lists all of the attributes defined uniquely on this class, and the “Inherited XML Attributes” table that follows lists all those that the widget inherits from superclasses, such as `View`. Of course, the JavaDocs also list the fields, constants, constructors, and public/protected methods that you can use on the widget itself.

This book does not attempt to explain each and every attribute on each and every widget. We will, however, cover the most popular widgets and the most commonly-used attributes on those widgets.

### Referencing Widgets By ID

Many widgets and containers only need to appear in the XML layout file and do not need to be referenced in your Java code. For example, a static label (`TextView`) frequently only needs to be in the layout file to indicate where it should appear.

Anything you *do* want to use in your Java source, though, needs an `android:id`.

The convention is to use `@+id/...` as the `id` value, where the `...` represents your locally-unique name for the widget in question, for the first occurrence of a given `id` value in your layout file. The second and subsequent occurrences in the same layout file should drop the `+` sign.

Android provides a few special `android:id` values, of the form `@android:id/...` — we will see some of these in various chapters of this book.

To access our identified widgets, use `findViewById()`, passing it the numeric identifier of the widget in question. That numeric identifier was generated by Android in the `R` class as `R.id.something` (where `something` is the specific widget you are seeking).

This concept will become important as we try to attach listeners to our widgets (e.g., finding out when a checkbox is checked) or when we try referencing widgets from other widgets in a layout XML file (e.g., with `RelativeLayout`). All of this will be covered later in this chapter.

### Size

Most of the time, we need to tell Android how big we want our widgets to be. Occasionally, this will be handled for us — we will see an example of that with `TableLayout` in [an upcoming chapter](#). But generally we need to provide this information ourselves.

To do that, you need to supply `android:layout_width` and `android:layout_height` attributes on your widgets in the XML layout file. These attributes' values have three flavors:

1. You can provide a specific dimension, such as `125dip` to indicate the widget should take up exactly a certain size (here, 125 density-independent pixels)

2. You can provide `wrap_content`, which means the widget should take up as much room as its contents require (e.g., a `TextView` label widget's content is the text to be displayed)
3. You can provide `fill_parent`, which means the widget should fill up all remaining available space in its enclosing container

The latter two flavors are the most common, as they are independent of screen size, allowing Android to adjust your view to fit the available space.

*NOTE:* In API level 8 (Android 2.2), `fill_parent` was renamed to `match_parent`, for unknown reasons. You can still use `fill_parent`, as it will be supported for the foreseeable future. However, at such point in time as you are only supporting API level 8 or higher (e.g., `android:minSdkVersion="8"` in your manifest), you should probably switch over to `match_parent`.

This chapter focuses on individual widgets. Size becomes much more important when we start combining multiple widgets on the screen at once, and so we will be spending more time on sizing scenarios in later chapters.

The `layout_` prefix on these attributes means that these attributes represent requests by the widget to its enclosing container. Whether those requests will be truly honored will depend a bit on what other widgets there are in the container and what *their* requests are.

## Assigning Labels

The simplest widget is the label, referred to in Android as a `TextView`. Like in most GUI toolkits, labels are bits of text not editable directly by users. Typically, they are used to identify adjacent widgets (e.g., a “Name:” label before a field where one fills in a name).

In Java, you can create a label by creating a `TextView` instance. More commonly, though, you will create labels in XML layout files by adding a `TextView` element to the layout, with an `android:text` property to set the value of the label itself. If you need to swap labels based on certain criteria, such as internationalization, you may wish to use a string resource reference in the XML instead (e.g., `@string/label`).

For example, in [our last tutorial](#), we still are using the automatically-generated `res/layout/main.xml` file, containing, among other things, a `TextView`:

## BASIC WIDGETS

---

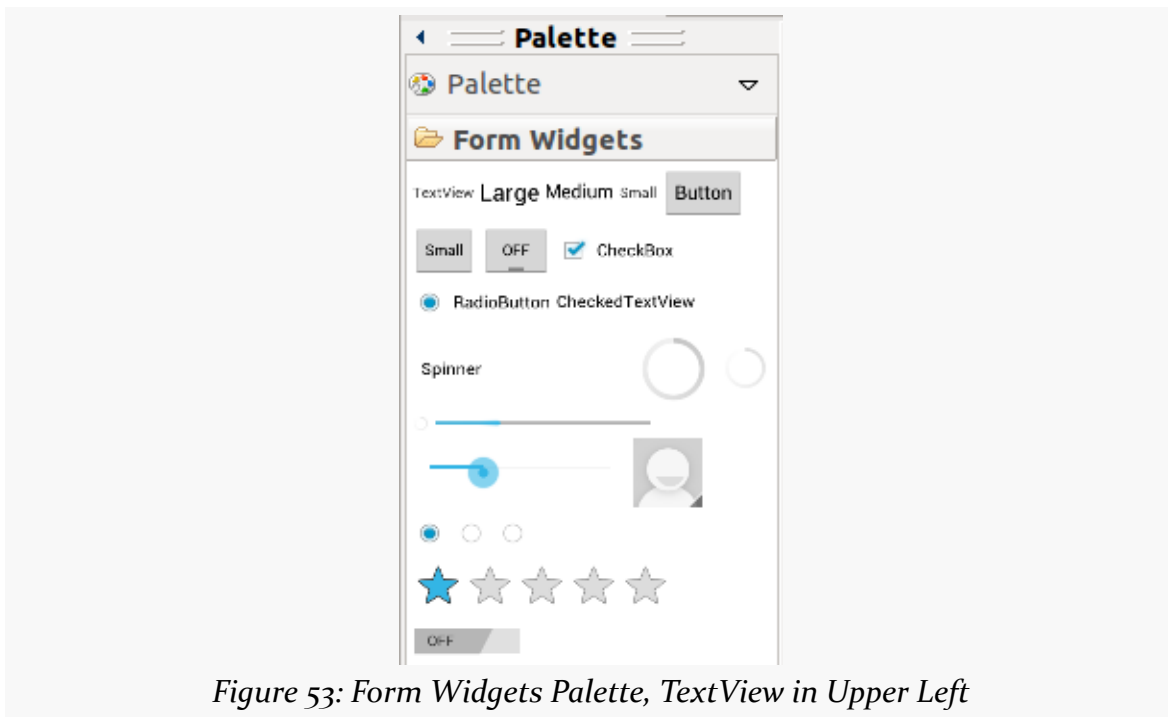
```
<RelativeLayout xmlns:android="http://schemas.android.com/apk/res/android"
    xmlns:tools="http://schemas.android.com/tools"
    android:layout_width="match_parent"
    android:layout_height="match_parent"
    tools:context=".EmPubLiteActivity">

    <TextView
        android:layout_width="wrap_content"
        android:layout_height="wrap_content"
        android:layout_centerHorizontal="true"
        android:layout_centerVertical="true"
        android:text="@string/hello_world"/>

</RelativeLayout>
```

### Eclipse Graphical Layout Editor

The TextView widget is available in the “Form Widgets” portion of the Palette in the Eclipse graphical layout editor:



You can drag that TextView from the palette into a layout file in the main editing area to add the widget to the layout. Or, drag it over top of some container you see in the Outline pane of the editor to add it as a child of that specific container:

## BASIC WIDGETS

---

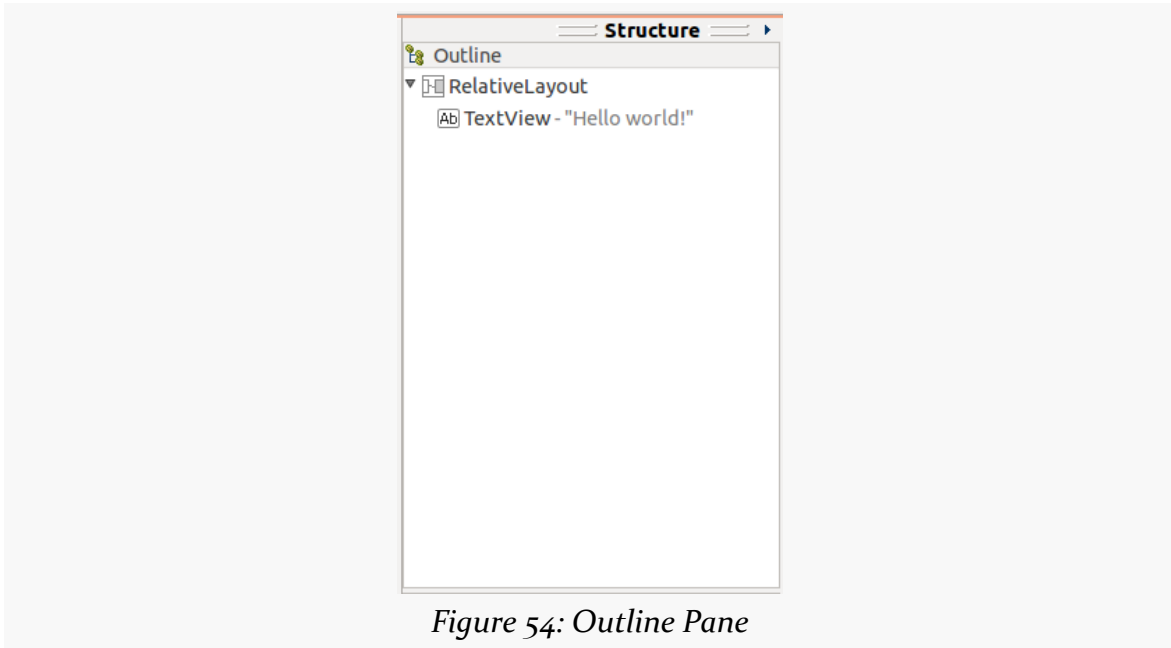


Figure 54: Outline Pane

Clicking on the resulting TextView in the Outline pane will set up the Properties pane with the various attributes of the widget, ready for you to change as needed:

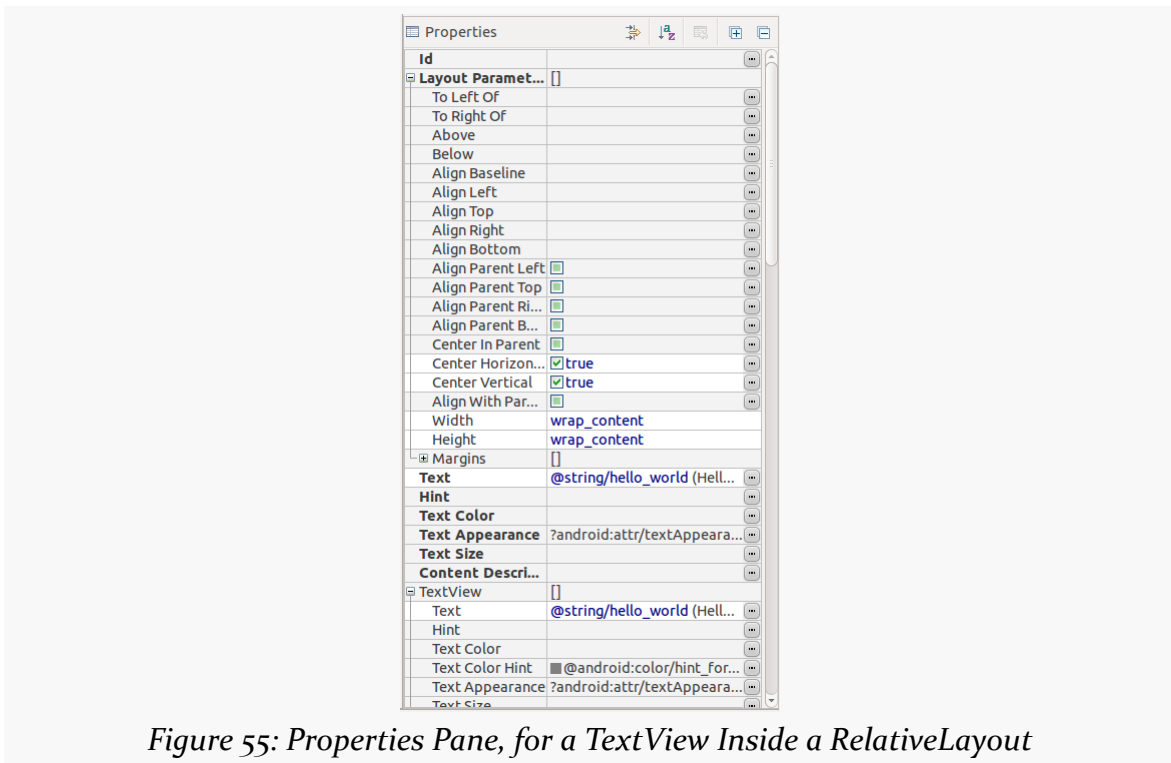
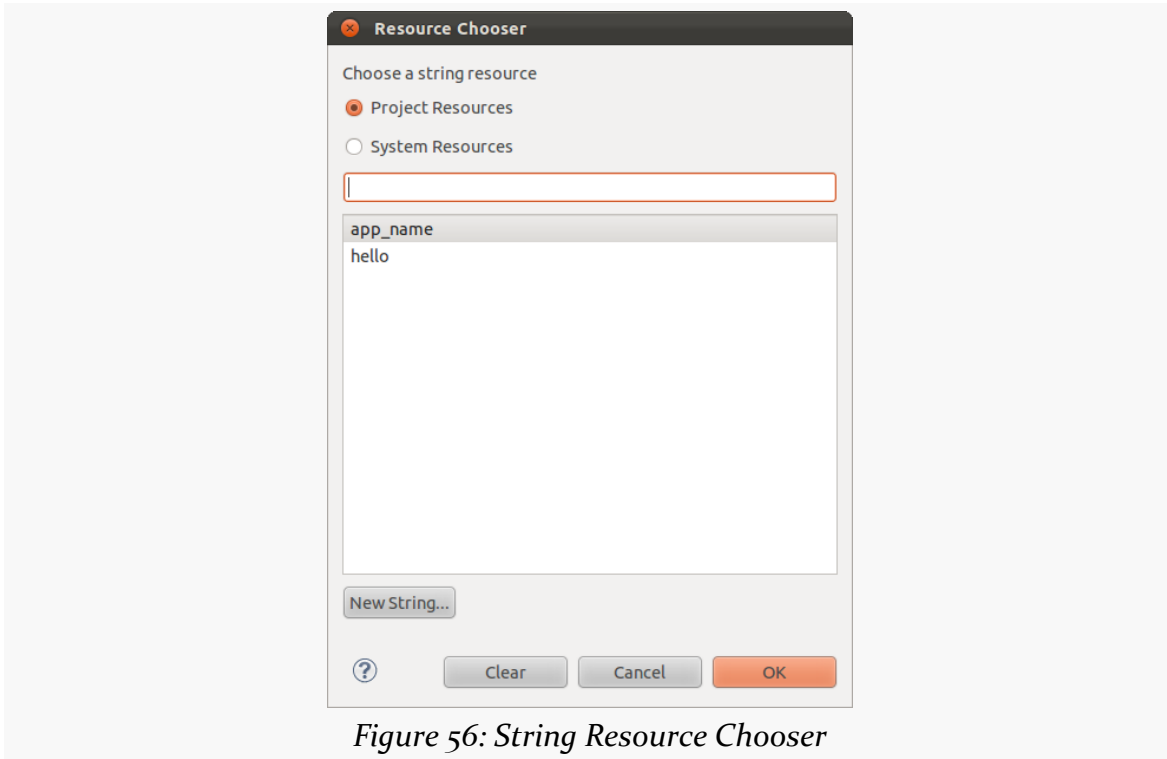


Figure 55: Properties Pane, for a TextView Inside a RelativeLayout



### Editing the Text

The “Text” property will allow you to choose or define a string resource to serve as the text to be displayed. By default, it brings up a list of existing string resources:



*Figure 56: String Resource Chooser*

You can highlight one of those resources and click “OK” to use it, or you can click the “New String...” button to define a brand-new string resource.

### Editing the ID

The “Id” property will allow you to change the `android:id` value of the widget. Be sure to include the `@+id/` prefix, as Android will not add that automatically for you.

### Notable TextView Attributes

TextView has numerous other attributes of relevance for labels, such as:

1. `android:typeface` to set the typeface to use for the label (e.g., monospace)

## BASIC WIDGETS

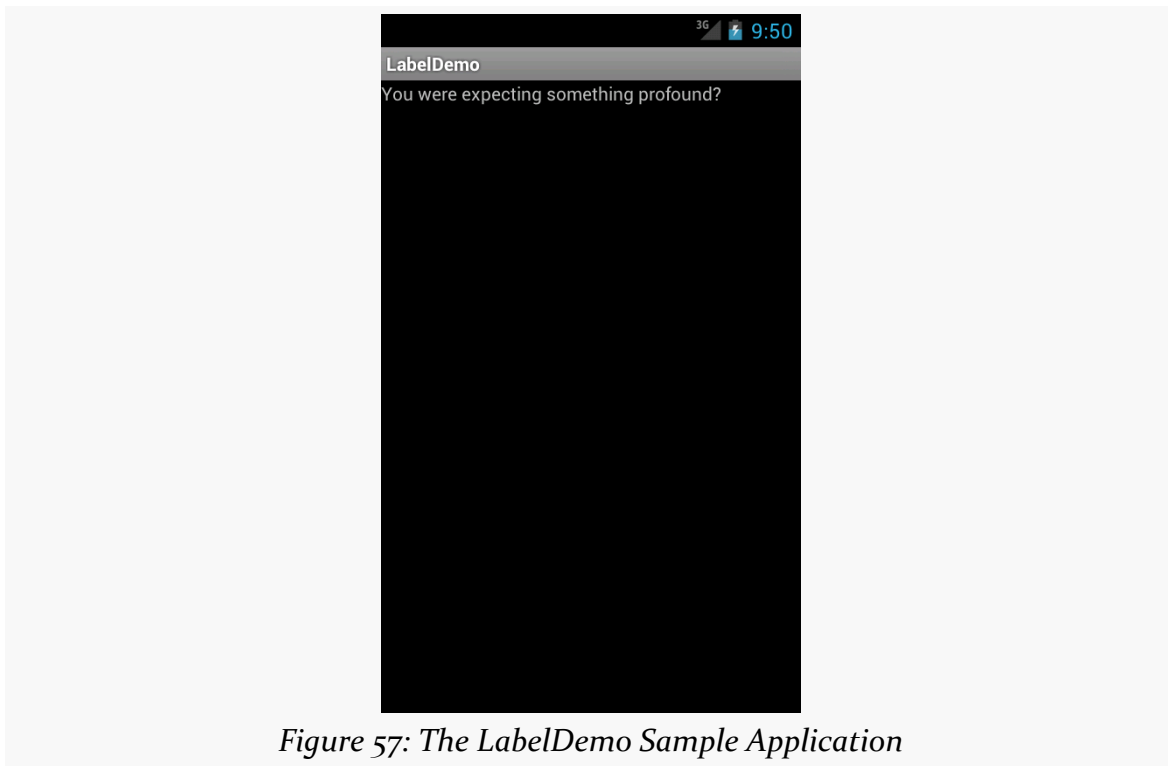
---

2. `android:textStyle` to indicate that the typeface should be made bold (bold), italic (italic), or bold and italic (bold\_italic)
3. `android:textColor` to set the color of the label's text, in RGB hex format (e.g., #FF0000 for red) or ARGB hex format (e.g., #88FF0000 for a translucent red)

For example, in the [Basic/Label](#) sample project, you will find the following layout file:

```
<?xml version="1.0" encoding="utf-8"?>
<TextView xmlns:android="http://schemas.android.com/apk/res/android"
    android:layout_width="fill_parent"
    android:layout_height="wrap_content"
    android:text="@string/profound"
/>
```

Just that layout alone, with the stub Java source provided by Android's project builder (e.g., `android create project`) and appropriate string resources, gives you:



*Figure 57: The LabelDemo Sample Application*

These attributes, like most others, can be modified through the Properties pane.

## A Commanding Button

Android has a `Button` widget, which is your classic push-button “click me and something cool will happen” widget. As it turns out, `Button` is a subclass of `TextView`, so everything discussed in the preceding section in terms of formatting the face of the button still holds.

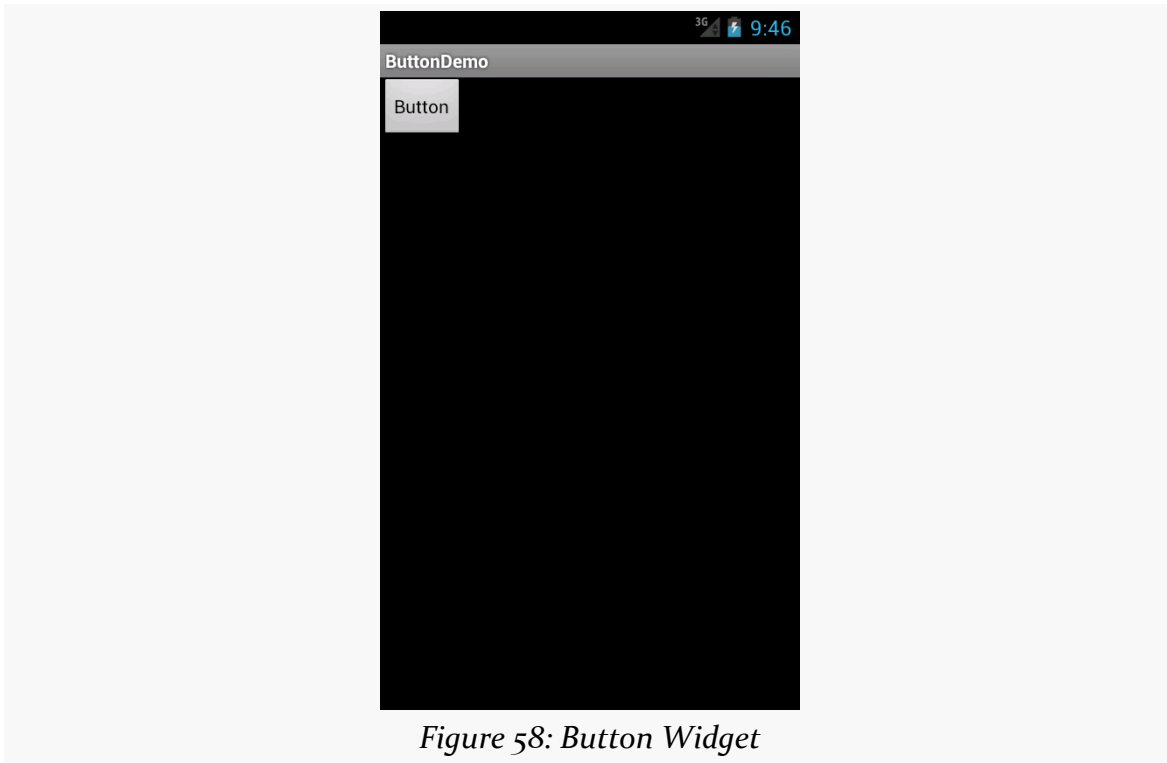
For example, in the [Basic/Button](#) sample project, you will find the following layout file:

```
<?xml version="1.0" encoding="utf-8"?>
<LinearLayout xmlns:android="http://schemas.android.com/apk/res/android"
    android:layout_width="fill_parent"
    android:layout_height="fill_parent"
    android:orientation="vertical">

    <Button
        android:id="@+id/button1"
        android:layout_width="wrap_content"
        android:layout_height="wrap_content"
        android:text="@string/button"/>

</LinearLayout>
```

Just that layout alone, with the stub Java source provided by Android’s project builder (e.g., `android create project`) and appropriate string resources, gives you:



*Figure 58: Button Widget*

### **Eclipse Graphical Layout Editor**

As with the TextView widget, the Button widget is available in the “Form Widgets” portion of the Palette in the Eclipse graphical layout editor:

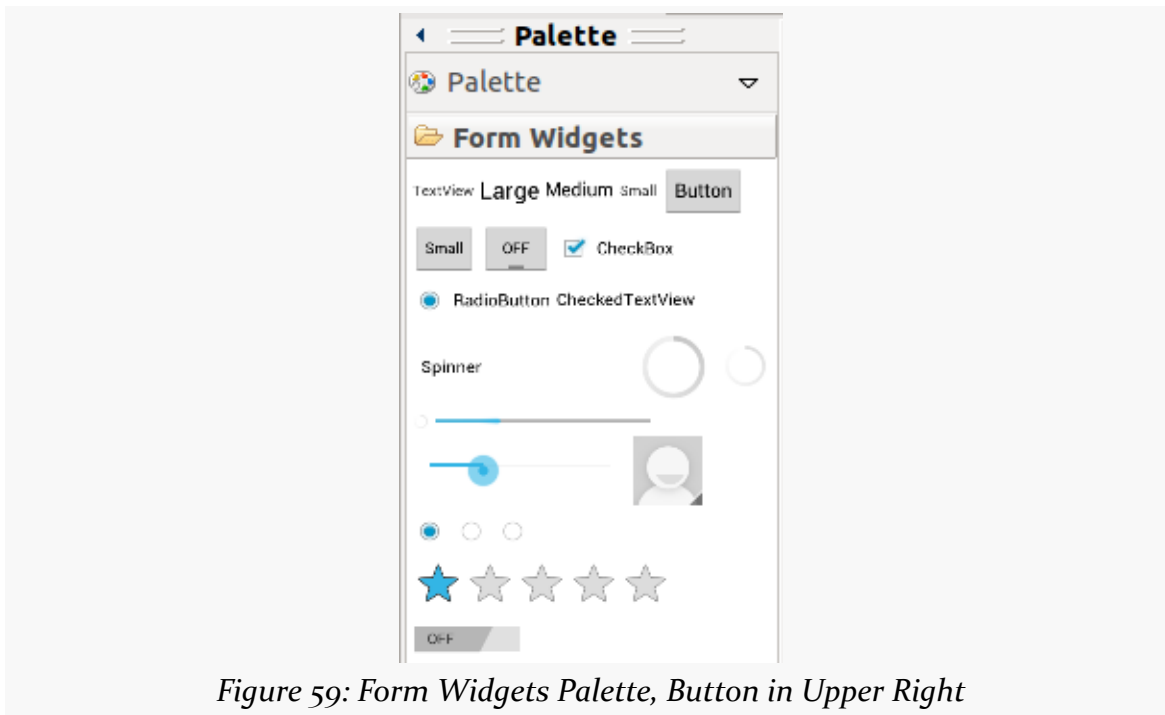


Figure 59: Form Widgets Palette, Button in Upper Right

You can drag that `Button` from the palette into a layout file in the main editing area to add the widget to the layout. The Properties pane will then let you adjust the various attributes of this `Button`. Since `Button` inherits from `TextView`, most of the options are the same (e.g., “Text”).

### Tracking Button Clicks

Buttons are command widgets — when the user presses a button, they expect something to happen.

To define what happens when you click a `Button`, you can:

1. Define some method on your Activity that holds the button that takes a single `View` parameter, has a `void` return value, and is `public`
2. In your layout XML, on the `Button` element, include the `android:onClick` attribute with the name of the method you defined in the previous step

For example, we might have a method on our Activity that looks like:

```
public void someMethod(View theButton) {  
    // do something useful here  
}
```

Then, we could use this XML declaration for the Button itself, including `android:onClick`:

```
<Button
  android:onClick="someMethod"
  ...
/>
```

This is enough for Android to “wire together” the Button with the click handler. When the user clicks the button, `someMethod()` will be called.

Another approach is to skip `android:onClick`, instead calling `setOnClickListener()` on the Button object in Java code. When a Button is used directly by an activity, this is not typically used — `android:onClick` is a bit cleaner. However, when we start to [talk about fragments](#), you will see that `android:onClick` does not work that well with fragments, and so we will use `setOnClickListener()` at that point.

## Fleeting Images

Android has two widgets to help you embed images in your activities: `ImageView` and `ImageButton`. As the names suggest, they are image-based analogues to `TextView` and `Button`, respectively.

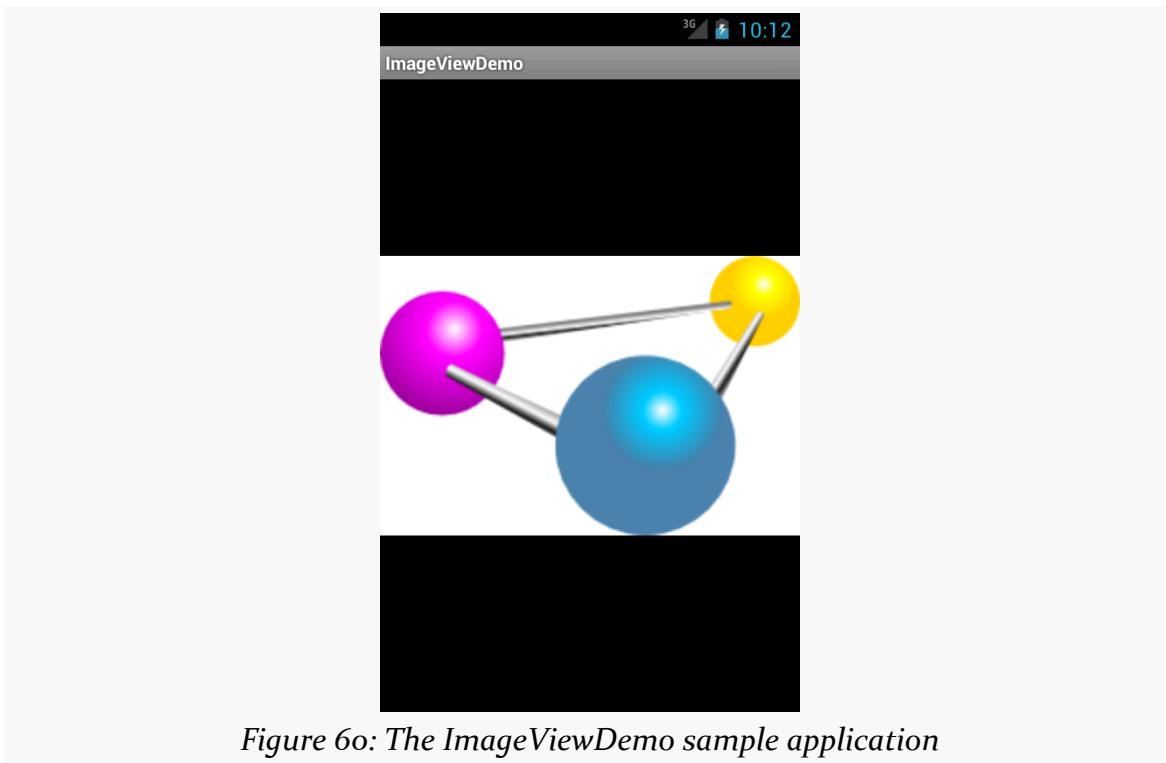
Each widget takes an `android:src` attribute (in an XML layout) to specify what picture to use. These usually reference a drawable resource (e.g., `@drawable/icon`).

`ImageButton`, a subclass of `ImageView`, mixes in the standard `Button` behaviors, for responding to clicks and whatnot.

For example, take a peek at the `main.xml` layout from the [Basic/ImageView](#) sample project:

```
<?xml version="1.0" encoding="utf-8"?>
<ImageView xmlns:android="http://schemas.android.com/apk/res/android"
  android:id="@+id/icon"
  android:layout_width="fill_parent"
  android:layout_height="fill_parent"
  android:adjustViewBounds="true"
  android:src="@drawable/molecule"/>
```

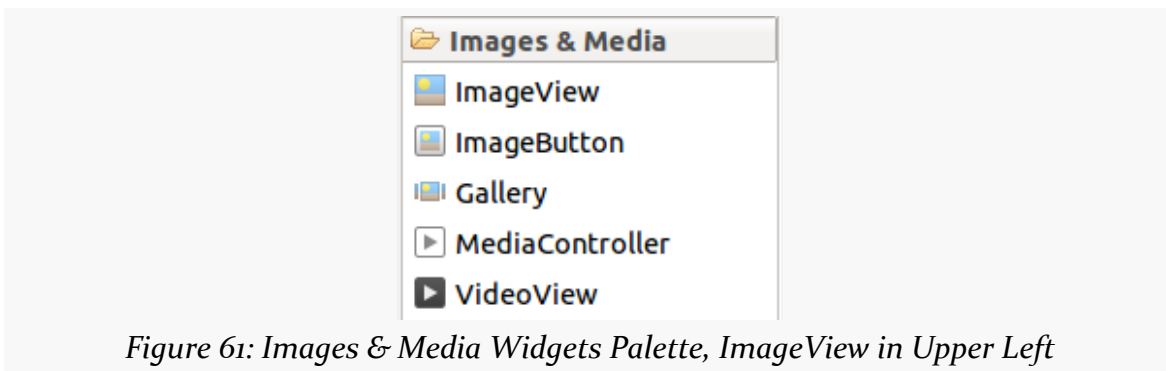
The result, just using the code-generated activity, is simply the image:



*Figure 60: The ImageViewDemo sample application*

### Eclipse Graphical Layout Editor

The ImageView widget can be found in the “Images & Media” portion of the Palette in the Graphical Layout editor:



*Figure 61: Images & Media Widgets Palette, ImageView in Upper Left*

The ImageButton widget is adjacent to the ImageView widget in the Palette.

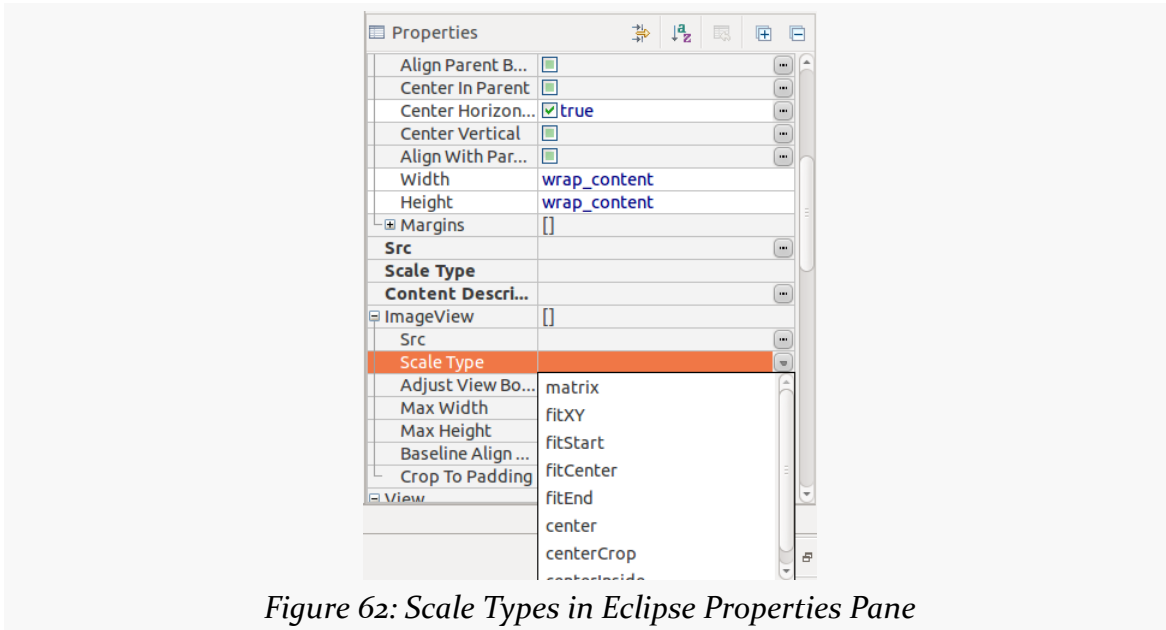
You can drag these into a layout file, then use the Properties pane to set their attributes. Like all widgets, you will have an “Id” option to set the android:id value

## BASIC WIDGETS

---

for the widget. Two others of importance, though, are more unique to `ImageView` and `ImageButton`:

- “Src” allows you to choose a drawable resource to use as the image to be displayed
- “Scale Type” opens a drop-down menu where you can choose how the image is to be scaled:

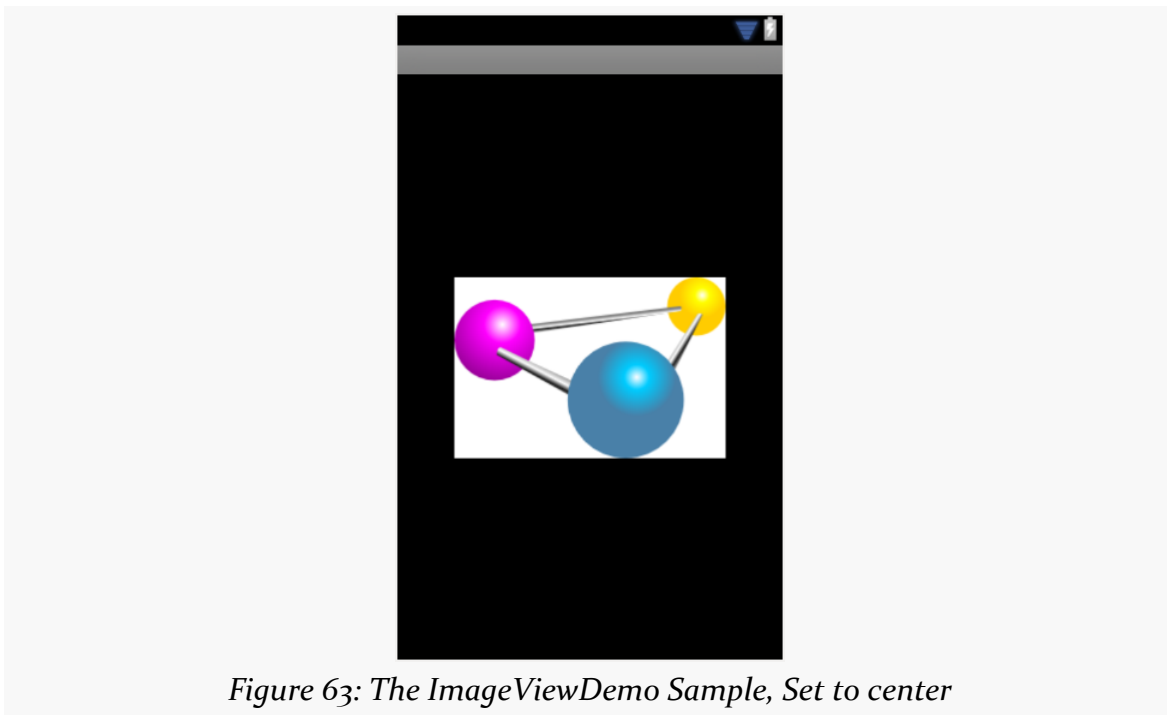


*Figure 62: Scale Types in Eclipse Properties Pane*

These values can be seen in the JavaDocs in [the `ImageView.ScaleType` class](#). The default (“fitCenter”) simply scales up the image to best fit the available space.

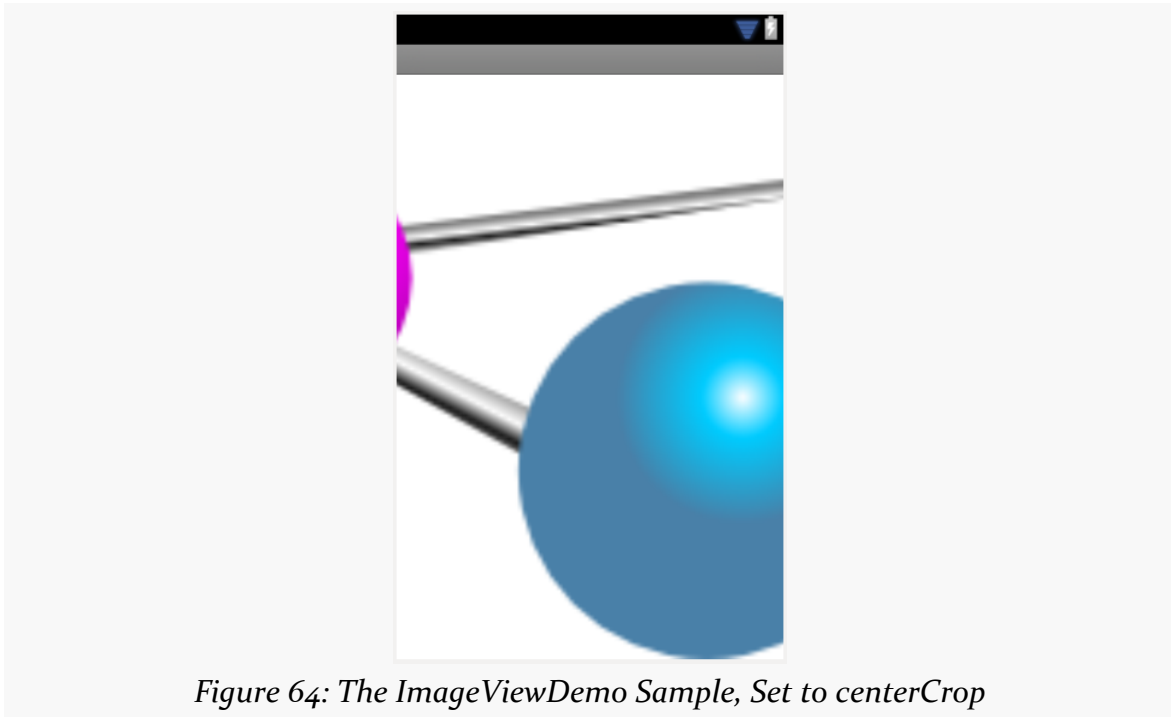
Of note, a choice of “center” will center the image in the available space but will not scale up the image:





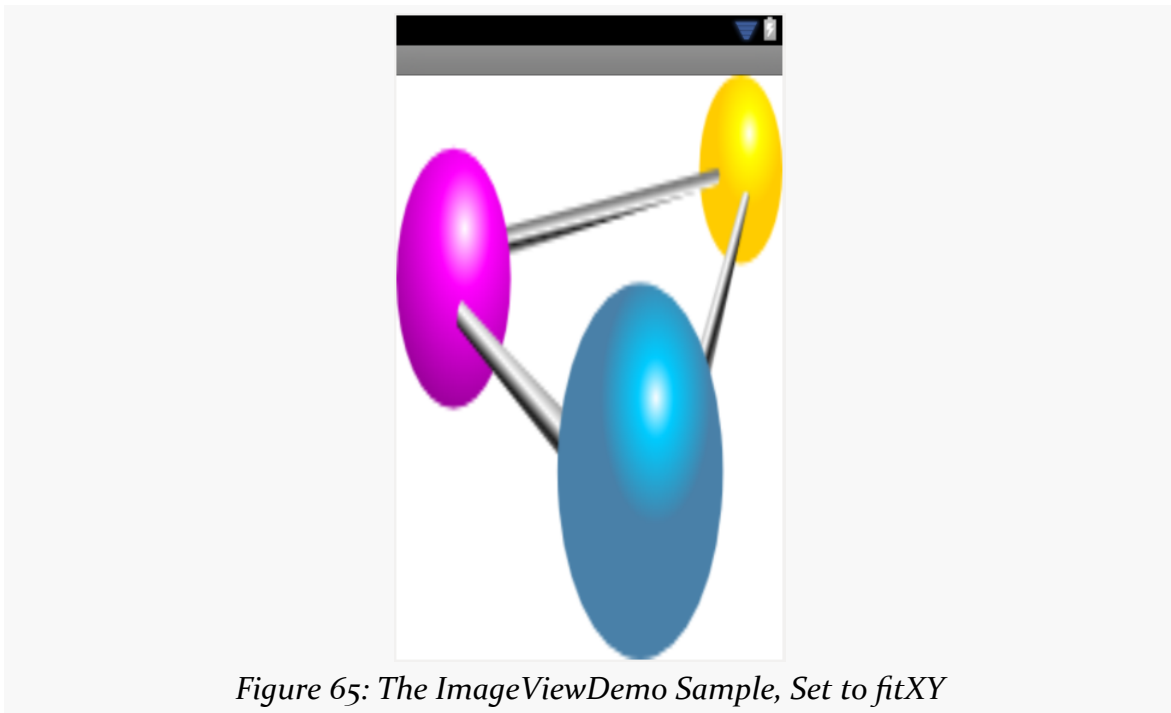
*Figure 63: The ImageViewDemo Sample, Set to center*

A choice of “centerCrop” will scale the image so that its shortest dimension fills the available space and crops the rest:



*Figure 64: The ImageViewDemo Sample, Set to centerCrop*

A choice of “fitXY” will scale the image to fill the space, ignoring the aspect ratio:



*Figure 65: The ImageViewDemo Sample, Set to fitXY*

## Fields of Green. Or Other Colors.

Along with buttons and labels, fields are the third “anchor” of most GUI toolkits. In Android, they are implemented via the `EditText` widget, which is a subclass of the `TextView` used for labels.

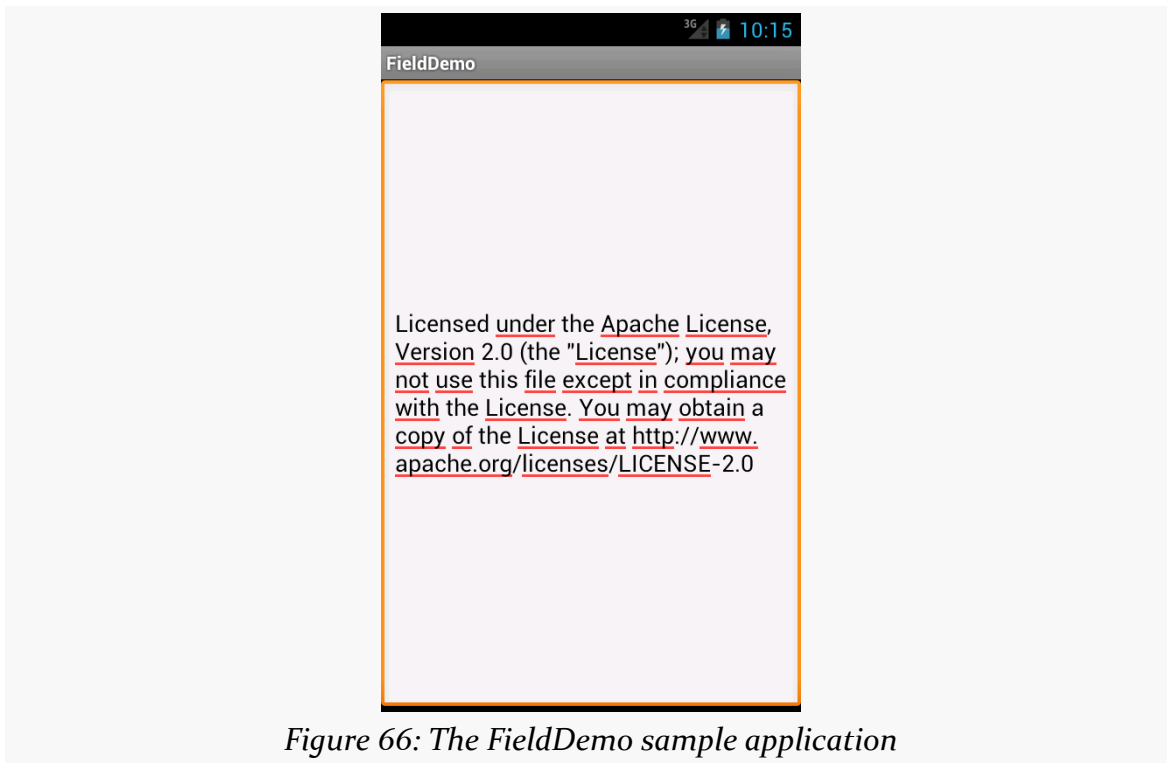
Along with the standard `TextView` attributes (e.g., `android:textStyle`), `EditText` has others that will be useful for you in constructing fields, notably `android:inputType`, to describe what sort of input your `EditText` expects (numbers? email addresses? phone numbers?). A thorough explanation of `android:inputType` and its interaction with input method editors (a.k.a., “soft keyboards”) will be discussed in an [upcoming chapter](#).

For example, from the [Basic/Field](#) sample project, here is an XML layout file showing an `EditText`:

```
<?xml version="1.0" encoding="utf-8"?>
<EditText xmlns:android="http://schemas.android.com/apk/res/android"
    android:id="@+id/field"
    android:layout_width="fill_parent"
    android:layout_height="fill_parent"
    android:inputType="textMultiLine"
    android:text="@string/license"
    />
```

Note that we have `android:inputType="textMultiLine"`, so users will be able to enter in several lines of text. We also have defined the initial text to be the value of a license string resource.

The result, once built and installed into the emulator, is:



*Figure 66: The FieldDemo sample application*

### Eclipse Graphical Layout Editor

The Graphical Layout's Palette has a whole section dedicated primarily to EditText widgets, named "Text Fields":

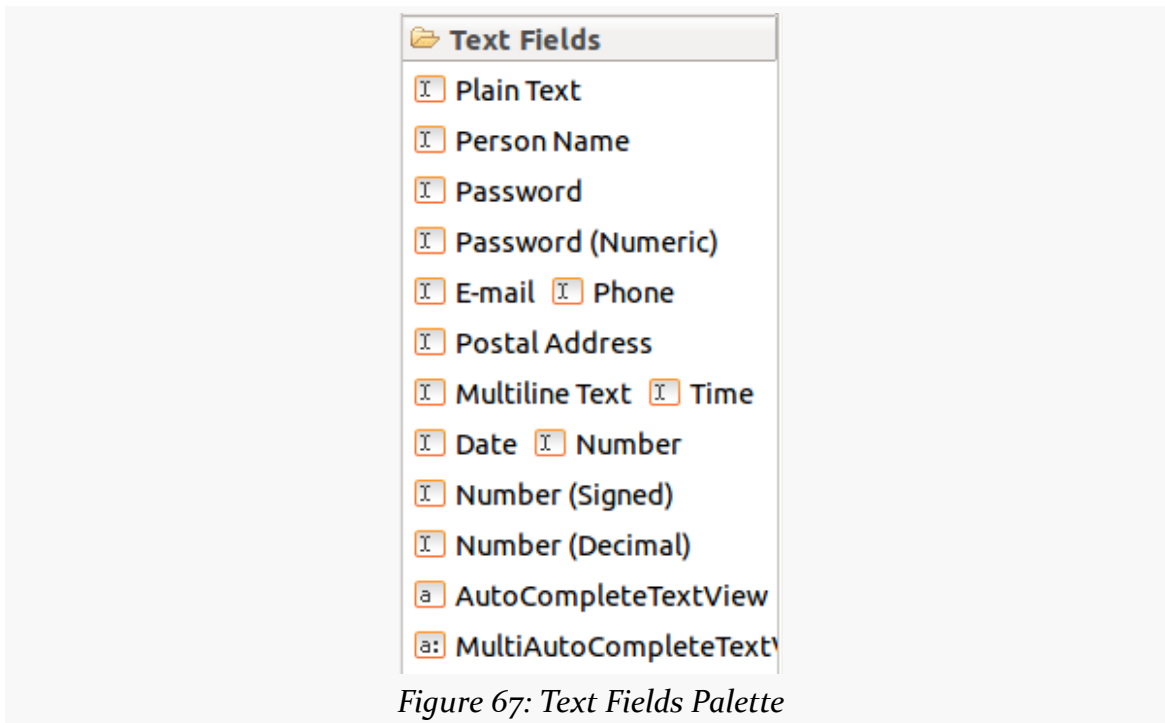


Figure 67: Text Fields Palette

The first entry is a general-purpose `EditText`. The rest come pre-configured for various scenarios, such as a person’s name or a postal address.

You can drag any of these into your layout, then use the Properties pane to configure relevant attributes. The “Id” and “Text” attributes are the same as found on `TextView`, as are many other properties, as `EditText` inherits from `TextView`.

### Notable `EditText` Attributes

The “Request Focus” item *in the context menu* (right-click over the `EditText` widget) allows you to indicate that this `EditText` should be the widget that receives the focus when this layout is loaded onto the screen. By default, the focus goes to the focusable widget that is first (i.e., closest to the upper-left corner), but you can override that using this attribute.

The “Hint” item in the Properties pane allows you to set a “hint” for this `EditText`. The “hint” text will be shown in light gray in the `EditText` widget when the user has not entered anything yet. Once the user starts typing into the `EditText`, the “hint” vanishes. This might allow you to save on screen space, replacing a separate label `TextView`.

## BASIC WIDGETS

---

The “Input Type” item in the Properties pane allows you to describe what sort of input you are expecting to receive in this `EditText`, lining up with many of the types of fields you can drag from the Palette into the layout:

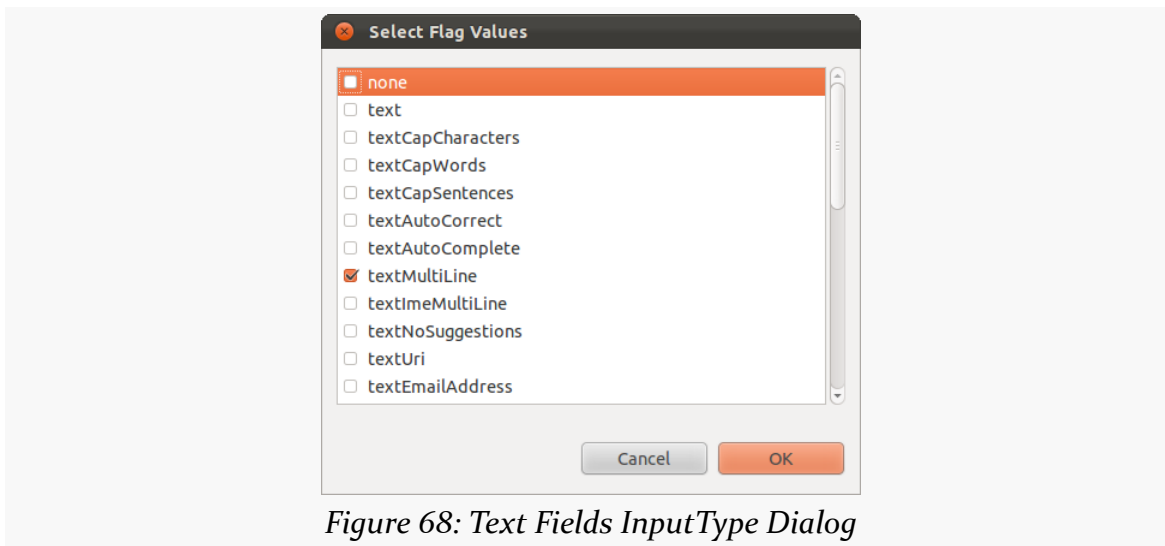


Figure 68: Text Fields InputType Dialog

## More Common Concepts

All widgets, including the ones shown above, extend `View`. The `View` base class gives all widgets an array of useful attributes and methods beyond those already described.

### Padding

Widgets have a minimum size, one that may be influenced by what is inside of them. So, for example, a `Button` will expand to accommodate the size of its caption. You can control this size using padding. Adding padding will increase the space between the contents (e.g., the caption of a `Button`) and the edges of the widget.

Padding can be set once in XML for all four sides (`android:padding`) or on a per-side basis (`android:paddingLeft`, etc.). Padding can also be set in Java via the `setPadding()` method.

The value of any of these is a dimension — a combination of a unit of measure and a count. So, `5px` is 5 pixels, `10dip` is 10 density-independent pixels, or `2mm` is 2 millimeters.

### Margins

By default, widgets are tightly packed, one next to the other. You can control this via the use of margins, a concept that is reminiscent of the padding described previously.

The difference between padding and margins comes in terms of the background. For widgets with a transparent background — like the default look of a `TextView` — padding and margins have similar visual effect, increasing the space between the widget and adjacent widgets. However, for widgets with a non-transparent background — like a `Button` — padding is considered inside the background while margins are outside. In other words, adding padding will increase the space between the contents (e.g., the caption of a `Button`) and the edges, while adding margin increases the empty space between the edges and adjacent widgets.

Margins can be set in XML, either on a per-side basis (e.g., `android:layout_marginTop`) or on all sides via `android:layout_margin`. Once again, the value of any of these is a dimension — a combination of a unit of measure and a count, such as `5px` for 5 pixels.

### Colors

There are two types of color attributes in Android widgets. Some, like `android:background`, take a single color (or a graphic image to serve as the background). Others, like `android:textColor` on `TextView` (and subclasses) can take a `ColorStateList`, including via the Java setter (in this case, `setTextColor()`).

A `ColorStateList` allows you to specify different colors for different conditions. For example, when you get to selection widgets in an upcoming chapter, you will see how a `TextView` has a different text color when it is the selected item in a list compared to when it is in the list but not selected. This is handled via the default `ColorStateList` associated with `TextView`.

If you wish to change the color of a `TextView` widget in Java code, you have two main choices:

- Use `ColorStateList.valueOf()`, which returns a `ColorStateList` in which all states are considered to have the same color, which you supply as the parameter to the `valueOf()` method. This is the Java equivalent of the `android:textColor` approach, to make the `TextView` always a specific color regardless of circumstances.

- Create a `ColorStateList` with different values for different states, either via the constructor or via an XML drawable resource.

### Other Useful Attributes

Some additional attributes on `View` most likely to be used include:

1. `android:visibility`, which controls whether the widget is initially visible
2. `android:nextFocusDown`, `android:nextFocusLeft`, `android:nextFocusRight`, and `android:nextFocusUp`, which control the focus order if the user uses the D-pad, trackball, or similar pointing device
3. `android:contentDescription`, which is roughly equivalent to the `alt` attribute on an HTML `<img>` tag, and is used by accessibility tools to help people who cannot see the screen navigate the application — this is very important for widgets like `ImageView`

### Useful Methods

You can toggle whether or not a widget is enabled via `setEnabled()` and see if it is enabled via `isEnabled()`. One common use pattern for this is to disable some widgets based on a `CheckBox` or `RadioButton` selection.

You can give a widget focus via `requestFocus()` and see if it is focused via `isFocused()`. You might use this in concert with disabling widgets as mentioned above, to ensure the proper widget has the focus once your disabling operation is complete.

To help navigate the tree of widgets and containers that make up an activity's overall view, you can use:

1. `getParent()` to find the parent widget or container
2. `findViewById()` to find a child widget with a certain ID
3. `getRootView()` to get the root of the tree (e.g., what you provided to the activity via `setContentView()`)

### Visit the Trails!

You can learn more about Android's input method framework — what you might think of as soft keyboards — [in a later chapter](#).



## BASIC WIDGETS

---

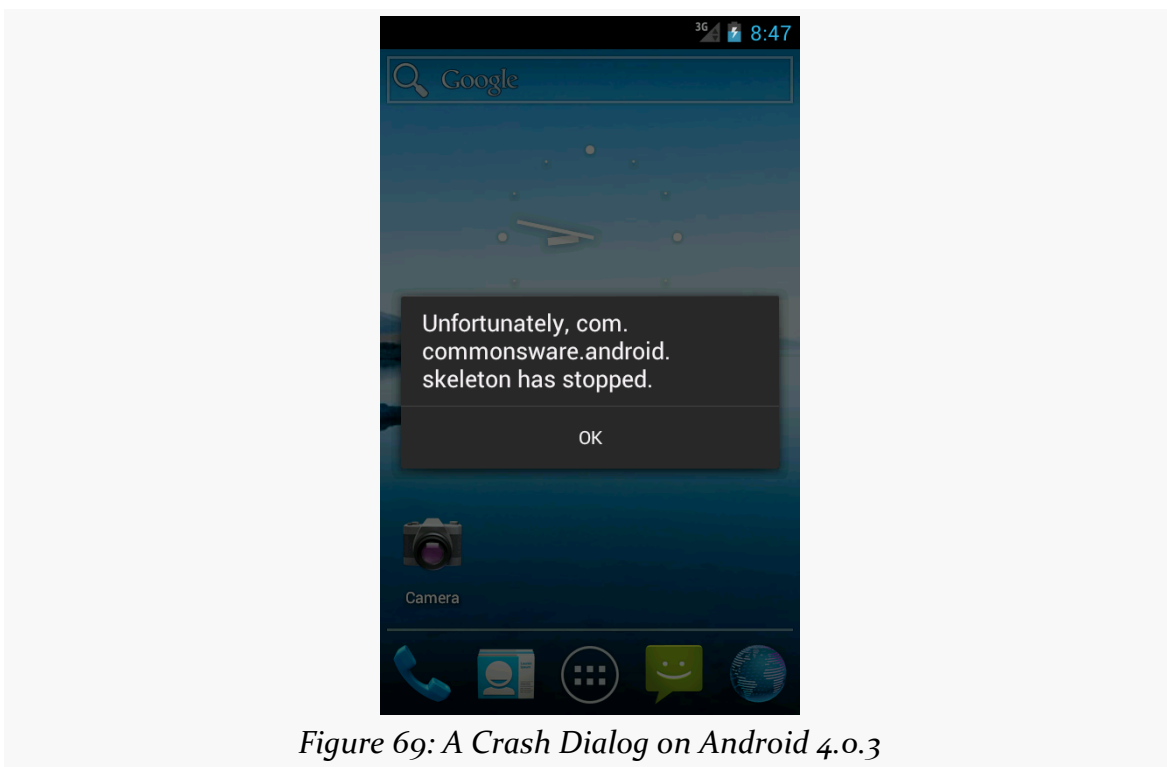
Another chapter in the trails covers [the use of fonts](#), to tailor your TextView widgets (and those that inherit from them, like Button).

Yet another chapter in the trails covers [rich text formatting](#), both for presenting formatted text in a TextView (e.g., inline **boldface**) and for collecting formatted text from the user via a customized EditText.

# Debugging Crashes

---

Now that we are starting to manipulate layouts and Java code more significantly, the odds increase that we are going to somehow do it wrong, and our app will crash.



*Figure 69: A Crash Dialog on Android 4.0.3*

In this chapter, we will cover a few tips on how to debug these sorts of issues.

## Get Thee To a Stack Trace

If you see one of those “Force Close” or “Has Stopped” dialogs, the first thing you will want to do is examine the Java stack trace that is associated with this crash. These are logged to a facility known as LogCat, on your device or emulator.

To view LogCat, you have three choices:

1. Use the `adb logcat` command at the command line (or something that uses `adb logcat`, such as various colorizing scripts available online)
2. Use the LogCat tab in the standalone Android Device Monitor utility (run `monitor` from the command line)
3. Use the LogCat view in Eclipse

There are also LogCat apps on the Play Store, such as aLogCat, that will display the contents of LogCat. However, for security and privacy reasons, on Jelly Bean and higher devices, such apps will only be able to show you *their* LogCat entries, not those from the system, your app, or anyone else. Hence, for development purposes, it is better to use one of the other alternatives outlined above.

The LogCat view is available at any time, from pretty much anywhere in Eclipse, by means of clicking on the LogCat icon in the status bar of your Eclipse window:



LogCat will show your stack traces, diagnostic information from the operating system, and anything you wish to include via calls to static methods on the `android.util.Log` class. For example, `Log.e()` will log a message at error severity, causing it to be displayed in red.

## DEBUGGING CRASHES

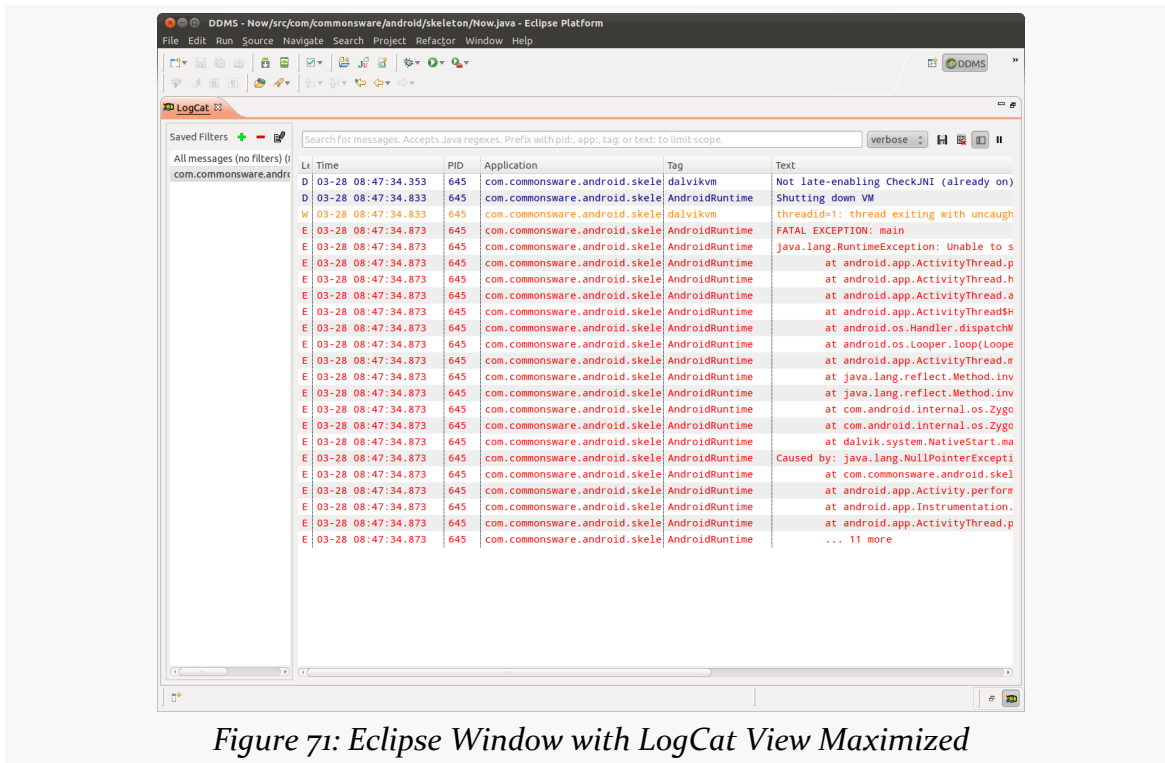


Figure 71: Eclipse Window with LogCat View Maximized

By default, when developing your app, if your app crashes, LogCat will display messages from your app alone, via a filter on the left, with the name of your app's package (e.g., `com.commonware.android.skeleton`). Switching the filter to "All messages (no filters)" will show all LogCat messages, regardless of origin.

There is a scrollbar towards the bottom of the main log area that will let you see more of your stack trace:

## DEBUGGING CRASHES

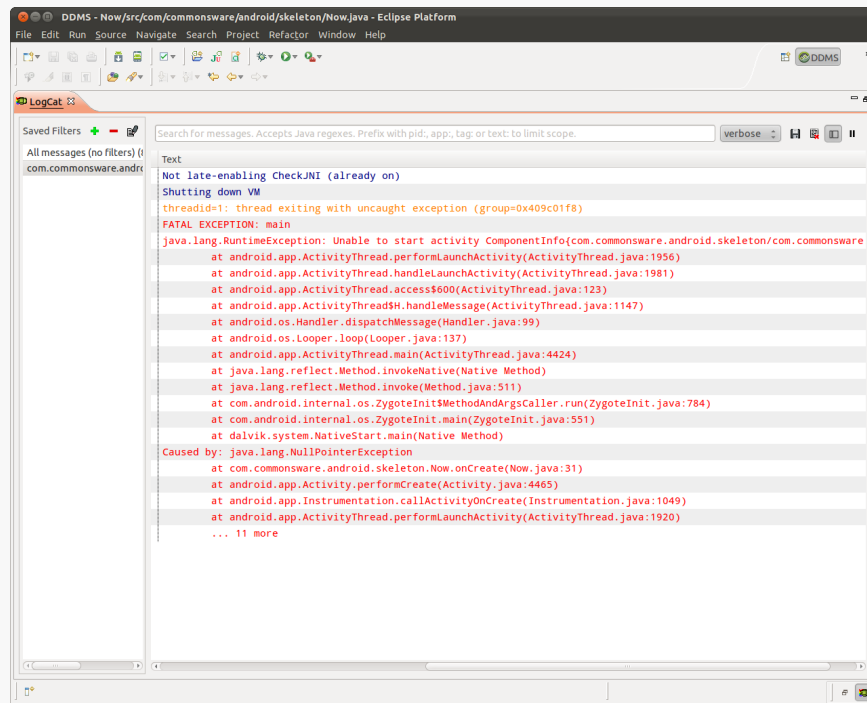


Figure 72: Eclipse Window with LogCat View Scrolled Right

Your stack trace will typically consist of two or more “stanzas”. Your own code will typically be in the last of these. So, in the screenshot above, we have `java.lang.RuntimeException: Unable to start activity...`, followed by `Caused by: java.lang.NullPointerException`, as a pair of stanzas. The point where our code crashed shows up in that second stanza (at `com.commonware.android.skeleton.Now.onCreate(Now.java:31)`).

If you double-click on a line in the stack trace corresponding with your code, you will be taken to a Java editor on that source file and line, so you can see what code triggered the exception.

If you wish to save one of these stack traces as a file, to attach to an issue in an issue tracker or something, highlight the lines you want in LogCat (click on the first line, then `<Shift>`-click on the last line), then click on the “Export Selected Items to Text File” icon (looks like a 3.5-inch floppy disk or a classic “save” icon). This will bring up your platform’s “Save As” dialog, where you can specify where to write out the file.

The icon immediately to the right is the “clear” icon:



*Figure 73: LogCat Save and Clear Icons*

Clicking it will appear to clear LogCat. It definitely clears your LogCat *view*, so you will only see messages logged after you cleared it. Note, though, that this does not actually clear the logs from the device or emulator.

## The Case of the Confounding Class Cast

If you crash, the stack trace might suggest that there is a problem tied to your resources. One common flavor of this is a `ClassCastException` when you call `findViewById()`. For example, you might call `(Button)findViewById(R.id.button)`, yet get a `ClassCastException: android.widget.LinearLayout` as a result, indicating that while you thought your `findViewById()` call would return a `Button`, it really returned a `LinearLayout`.

Often times, this is not your fault. Sometimes, the R values get out of sync with pre-compiled classes from previous builds. This most often occurs just after you change your mix of resources (e.g., add a new layout).

To resolve this, you need to clean your project. In Eclipse, this is a matter of selecting the project, then choosing `Project > Clean` from the Eclipse main menu. Outside of Eclipse, `ant clean` accomplishes much the same thing.

So, if you get a strange crash that seems like it might be related to resources, clean your project. If the problem goes away, you are set — if the problem persists, you will need to do a bit more debugging.

## Point Break

If you are an experienced Eclipse user, you are welcome to use any of Eclipse's standard debugging capabilities with your Android app, such as breakpoints.

## DEBUGGING CRASHES

---

Whether you debug on an emulator or on a device (with “USB Debugging” enabled in Settings), your breakpoints and such should work normally.

Note, however, that if you set up Eclipse to catch all unhandled exceptions, those exceptions will not be logged to LogCat unless you allow execution to proceed past the point of the exception. While this may not matter much to you during development, the LogCat stack trace is often easier for other developers to read, away from your Eclipse environment. So, if you wish to post a stack trace on an issue or on a support forum (e.g., StackOverflow), use the LogCat stack trace.

# LinearLayout and the Box Model

---

LinearLayout represents Android's approach to a box model — widgets or child containers are lined up in a column or row, one after the next. This works similarly to vbox and hbox in Flex and XUL, etc.

Flex and XUL use the box as their primary unit of layout. If you want, you can use LinearLayout in much the same way, eschewing some of the other containers. Getting the visual representation you want is mostly a matter of identifying where boxes should nest and what properties those boxes should have, such as alignment *vis-à-vis* other boxes.

## Concepts and Properties

To configure a LinearLayout, you have four main areas of control besides the container's contents: the orientation, the fill model, the weight, the gravity.

### Orientation

Orientation indicates whether the LinearLayout represents a row or a column. Just add the `android:orientation` property to your LinearLayout element in your XML layout, setting the value to be `horizontal` for a row or `vertical` for a column.

The orientation can be modified at runtime by invoking `setOrientation()` on the LinearLayout, supplying it either `HORIZONTAL` or `VERTICAL`.



### Fill Model

The point behind a `LinearLayout` — or any of the Android container classes — is to organize multiple widgets. Part of organizing those widgets is determining how much space each gets.

`LinearLayout` takes an “eldest child wins” approach towards allocating space. So, if we have a `LinearLayout` with three children, the first child will get its requested space. The second child will get its requested space, if there is enough room remaining, and likewise for the third child. So if the first child asks for all the space (e.g., this is a horizontal `LinearLayout` and the first child has `android:layout_width="fill_parent"`), the second and third children will wind up with zero width.

### Weight

But, what happens if we have two or more widgets that should split the available free space? For example, suppose we have two multi-line fields in a column, and we want them to take up the remaining space in the column after all other widgets have been allocated their space.

To make this work, in addition to setting `android:layout_width` (for rows) or `android:layout_height` (for columns), you must also set `android:layout_weight`. This property indicates what proportion of the free space should go to that widget. If you set `android:layout_weight` to be the same non-zero value for a pair of widgets (e.g., 1), the free space will be split evenly between them. If you set it to be 1 for one widget and 2 for another widget, the second widget will use up twice the free space that the first widget does. And so on.

The weight for a widget is zero by default.

Another pattern for using weights is if you want to allocate sizes on a percentage basis. To use this technique for, say, a horizontal layout:

1. Set all the `android:layout_width` values to be 0 for the widgets in the layout
2. Set the `android:layout_weight` values to be the desired percentage size for each widget in the layout
3. Make sure all those weights add up to 100

If you want to have space left over, not allocated to any widget, you can add an `android:weightSum` attribute to the `LinearLayout`, and ensure that the sum of the

## LINEARLAYOUT AND THE BOX MODEL

---

`android:layout_weight` attributes of the children are less than that sum. The children will each get space allocated based upon the ratio of their `android:layout_weight` compared to the `android:weightSum`, not compared to the sum of the weights. And there will be empty space that takes up the rest of the room not allocated to the children.

To see `android:layout_weight` in action, take a look at the [Containers/LinearPercent](#) sample project. Here, we have a `res/layout/main.xml` file containing a vertical `LinearLayout` with three `Button` widgets as children:

```
<?xml version="1.0" encoding="utf-8"?>
<LinearLayout xmlns:android="http://schemas.android.com/apk/res/android"
    android:layout_width="fill_parent"
    android:layout_height="fill_parent"
    android:orientation="vertical">

    <Button
        android:layout_width="fill_parent"
        android:layout_height="0dip"
        android:layout_weight="50"
        android:text="@string/fifty_percent"/>

    <Button
        android:layout_width="fill_parent"
        android:layout_height="0dip"
        android:layout_weight="30"
        android:text="@string/thirty_percent"/>

    <Button
        android:layout_width="fill_parent"
        android:layout_height="0dip"
        android:layout_weight="20"
        android:text="@string/twenty_percent"/>

</LinearLayout>
```

Each of the three `Button` widgets declares its height to be `0dip`. However, each also has an `android:layout_weight` attribute, with the top `Button` requesting a weight of 50, the middle `Button` a weight of 30, and the bottom `Button` a weight of 20.

The result is that the `Button` widgets' heights are allocated based solely upon those weights:

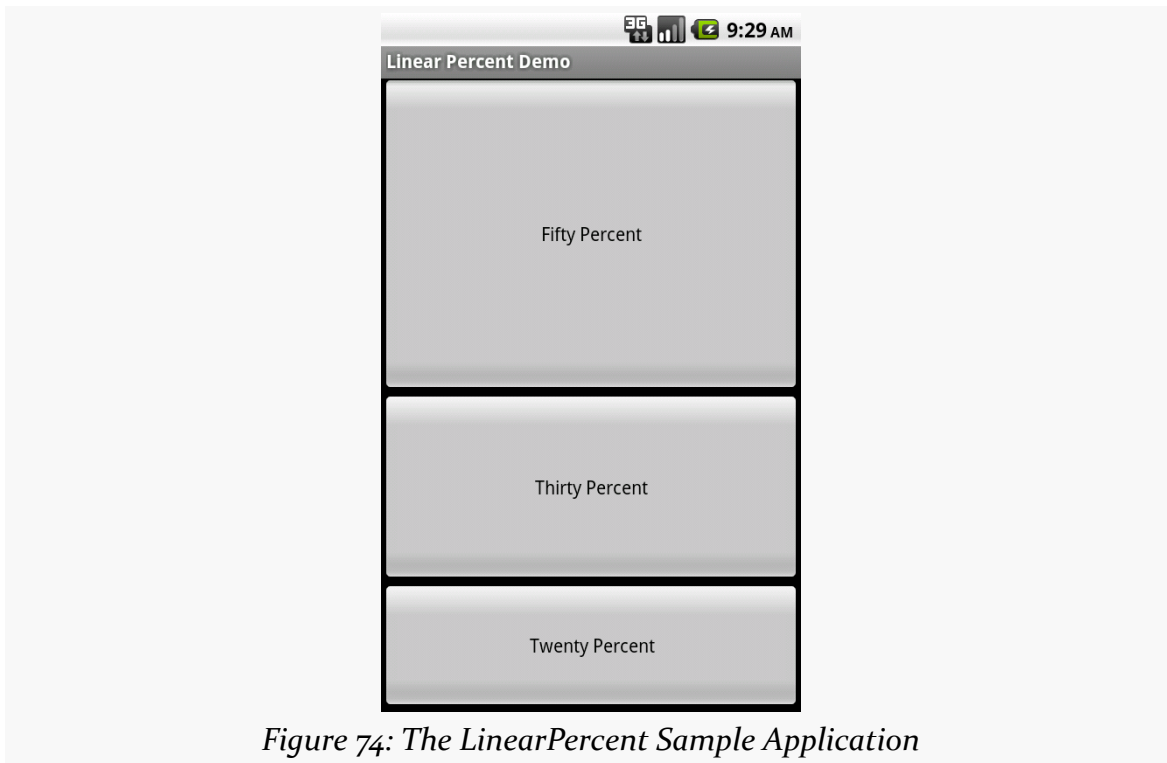


Figure 74: The LinearPercent Sample Application

### Gravity

By default, everything in a `LinearLayout` is left- and top-aligned. So, if you create a row of widgets via a horizontal `LinearLayout`, the row will start flush on the left side of the screen.

If that is not what you want, you need to specify a gravity. Unlike the physical world, Android has two types of gravity: the gravity of a widget within a `LinearLayout`, and the gravity of the contents of a widget or container.

The `android:gravity` property of some widgets and containers — which also can be defined via `setGravity()` in Java — tells Android to slide the contents of the widget or container in a particular direction. For example, `android:gravity="right"` says to slide the contents of the widget to the right; `android:gravity="right|bottom"` says to slide the contents of the widget to the right and the bottom.

Here, “contents” varies. `TextView` supports `android:gravity`, and the “contents” is the text held within the `TextView`. `LinearLayout` supports `android:gravity`, and the “contents” are the widgets inside the container. And so on. Note, though, that `android:gravity` on a `LinearLayout` only works in the direction of its orientation —

---

## LINEARLAYOUT AND THE BOX MODEL

---

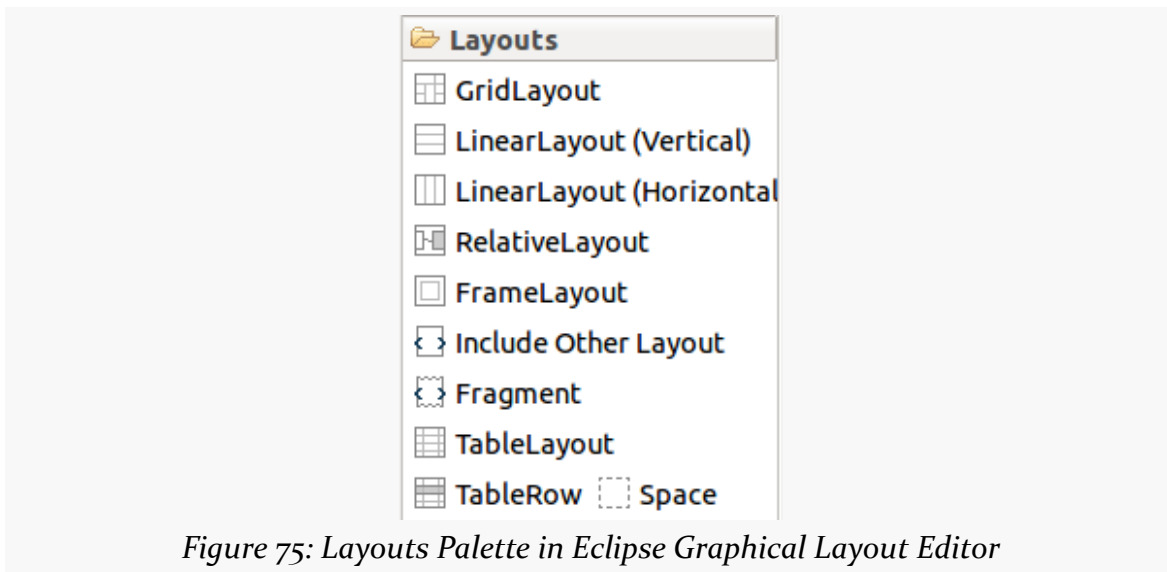
a vertical `LinearLayout` can use `android:gravity` to control the positioning of its children vertically (top or bottom) but not horizontally.

Children of a `LinearLayout` also have the option of specifying `android:layout_gravity`. Here, the child is telling the `LinearLayout` “if there is room, please slide me (and me alone) in this direction”. However, this only works in the direction *opposite* the orientation of the `LinearLayout` – the children of a vertical `LinearLayout` can use `android:layout_gravity` to control their positioning horizontally (left or right), but not vertically.

For a row of widgets, the default is for them to be aligned so their texts are aligned on the baseline (the invisible line that letters seem to “sit on”), though you may wish to specify a gravity of `center_vertical` to center the widgets along the row’s vertical midpoint.

## Eclipse Graphical Layout Editor

The `LinearLayout` container can be found in the “Layouts” portion of the Palette of the Eclipse graphical layout editor:



*Figure 75: Layouts Palette in Eclipse Graphical Layout Editor*

You can drag either the “`LinearLayout (Vertical)`” or “`LinearLayout (Horizontal)`” into a layout XML resource, then start dragging in children to go into the container.

## LINEARLAYOUT AND THE BOX MODEL

---

When your `LinearLayout` is the selected widget, a toolbar will appear over the preview:



Figure 76: *LinearLayout Toolbar in Eclipse Graphical Layout Editor*

The left two buttons toggle your `LinearLayout` between vertical and horizontal modes. The two immediately to the right of the divider toggle the width and height between `fill_parent` and `wrap_content`.

When one of the *children* of the `LinearLayout` is the selected widget, the toolbar changes:



Figure 77: *LinearLayout Contents Toolbar in Eclipse Graphical Layout Editor*

The left two buttons still toggle the orientation of the `LinearLayout`. The width and height buttons to their right toggle the width and height of the selected widget.

The right-most six buttons, from left to right, allow you to:

- Change the margins on the selected widget
- Change the gravity of the selected widget
- Give all widgets in the `LinearLayout` equal weight
- Give the selected widget all the weight
- Manually assign the weight to the selected widget
- Clear all weights from all widgets in the `LinearLayout`

The button that we have ignored — the one that looks like a lowercase ‘y’ on a dashed line — is supposed to be tied to aligning things on the baseline, but the button appears to be broken in the R20 and R21 version of the tools.

The Properties pane for the selected widget also allows you to get to the `LinearLayout` container to make adjustments to its attributes.

# Other Common Widgets and Containers

---

In [the chapter on basic widgets](#), we left out all of the classic “two-state” widgets, such as checkboxes and radio buttons. We will examine those and other related widgets in this chapter.

Beyond `LinearLayout`, Android supports a range of containers providing different layout rules. In this chapter, we will look at three commonly-used containers: `LinearLayout` (the box model), `RelativeLayout` (a rule-based model), and `TableLayout` (the grid model), along with `ScrollView` and `HorizontalScrollView`, containers that allow their contents to scroll. We will examine all of these containers in this chapter as well.

## Just a Box to Check

The classic checkbox has two states: checked and unchecked. Clicking the checkbox toggles between those states to indicate a choice (e.g., “Add rush delivery to my order”).

In Android, there is a `CheckBox` widget to meet this need. It has `TextView` as an ancestor, so you can use `TextView` properties like `android:textColor` to format the widget.

Within Java, you can invoke:

1. `isChecked()` to determine if the checkbox has been checked
2. `setChecked()` to force the checkbox into a checked or unchecked state
3. `toggle()` to toggle the checkbox as if the user clicked upon it

## OTHER COMMON WIDGETS AND CONTAINERS

---

Also, you can register a listener object (in this case, an instance of `OnCheckedChangeListener`) to be notified when the state of the checkbox changes.

For example, from [the Basic/CheckBox sample project](#), here is a simple checkbox layout:

```
<?xml version="1.0" encoding="utf-8"?>
<CheckBox xmlns:android="http://schemas.android.com/apk/res/android"
    android:id="@+id/check"
    android:layout_width="wrap_content"
    android:layout_height="wrap_content"
    android:text="@string/unchecked"/>
```

The corresponding `CheckBoxDemo.java` retrieves and configures the behavior of the checkbox:

```
package com.commonware.android.checkbox;

import android.app.Activity;
import android.os.Bundle;
import android.widget.CheckBox;
import android.widget.CompoundButton;

public class CheckBoxDemo extends Activity implements
    CompoundButton.OnCheckedChangeListener {
    CheckBox cb;

    @Override
    public void onCreate(Bundle icle) {
        super.onCreate(icle);
        setContentView(R.layout.main);

        cb=(CheckBox)findViewById(R.id.check);
        cb.setOnCheckedChangeListener(this);
    }

    public void onCheckedChanged(CompoundButton buttonView,
        boolean isChecked) {
        if (isChecked) {
            cb.setText(R.string.checked);
        }
        else {
            cb.setText(R.string.unchecked);
        }
    }
}
```

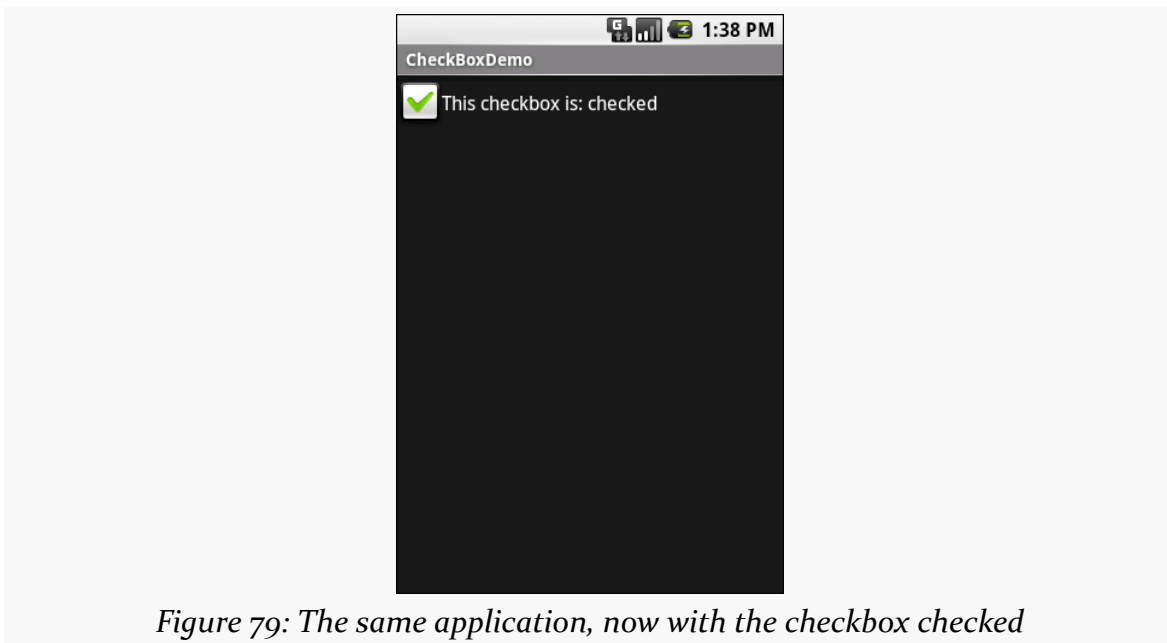
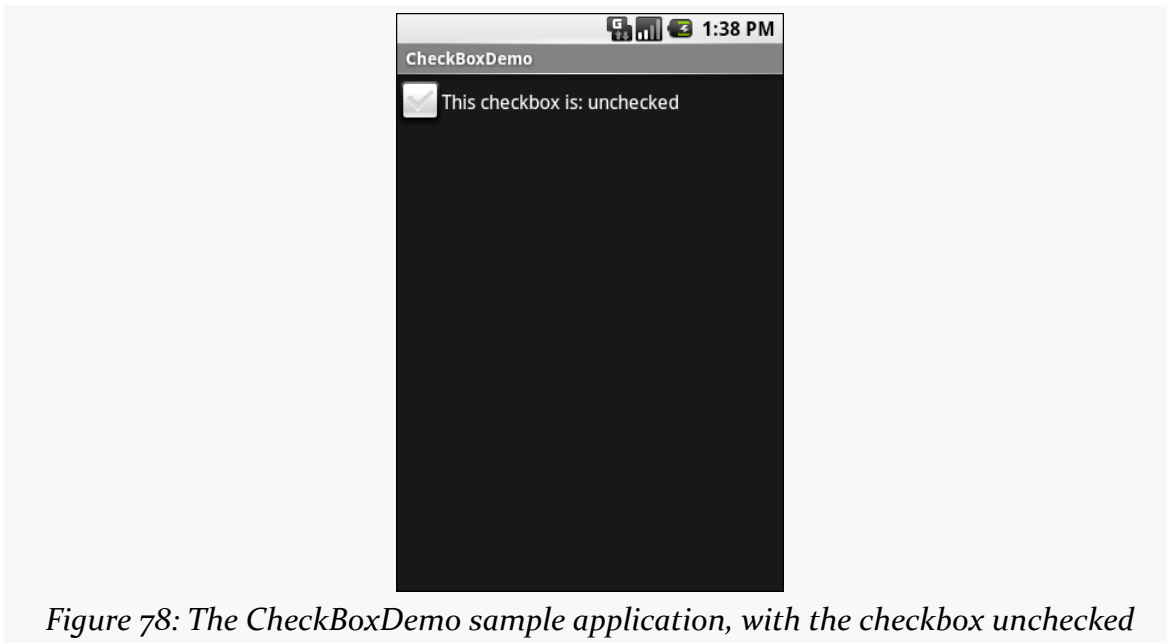
Note that the activity serves as its own listener for checkbox state changes since it implements the `OnCheckedChangeListener` interface (via `cb.setOnCheckedChangeListener(this)`). The callback for the listener is

## OTHER COMMON WIDGETS AND CONTAINERS

---

`onCheckedChanged()`, which receives the checkbox whose state has changed and what the new state is. In this case, we update the text of the checkbox to reflect what the actual box contains.

The result? Clicking the checkbox immediately updates its text, as shown below:



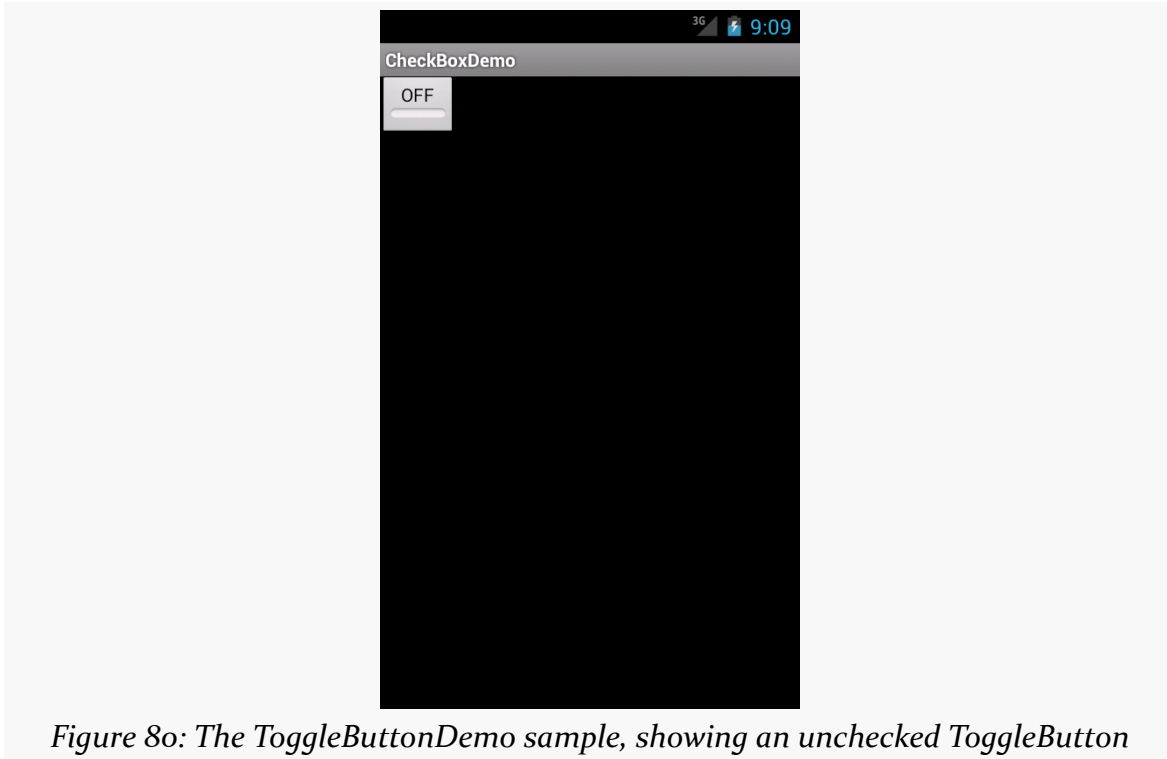


## Eclipse Graphical Layout Editor

The `CheckBox` widget appears in the “Form Widgets” section of the Palette in the Graphical Layout editor. You can drag it into the layout and configure it as desired using the Properties pane. As `CheckBox` inherits from `TextView`, most of the settings are the same as those you would find on a regular `TextView`.

## Don't Like Checkboxes? How About Toggles?

A similar widget to `CheckBox` is `ToggleButton`. Like `CheckBox`, `ToggleButton` is a two-state widget that is either checked or unchecked. However, `ToggleButton` has a distinct visual appearance:



*Figure 80: The `ToggleButtonDemo` sample, showing an unchecked `ToggleButton`*

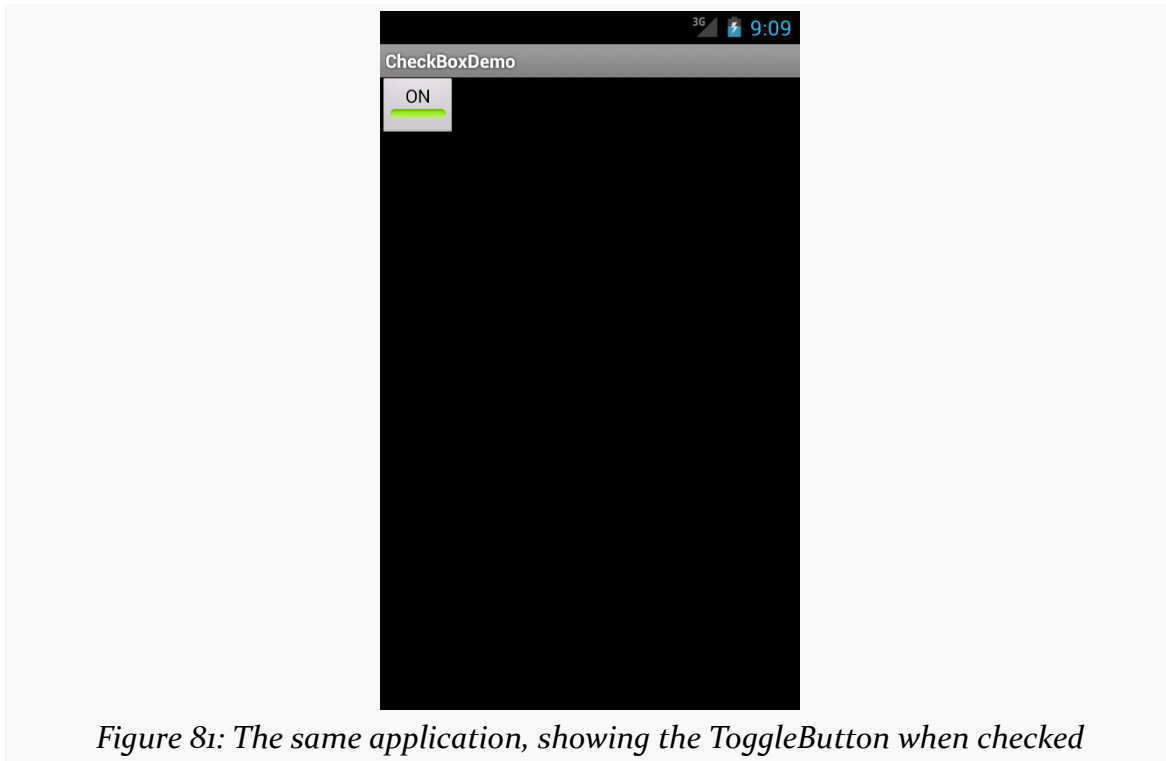


Figure 81: The same application, showing the `ToggleButton` when checked

Otherwise, `ToggleButton` behaves much like `CheckBox`. You can put it in a layout file, as seen in [the Basic/ToggleButton sample](#):

```
<?xml version="1.0" encoding="utf-8"?>
<ToggleButton xmlns:android="http://schemas.android.com/apk/res/android"
    android:id="@+id/toggle"
    android:layout_width="wrap_content"
    android:layout_height="wrap_content" />
```

You can also set up an `OnCheckedChangeListener` to be notified when the user changes the state of the `ToggleButton`.

### Eclipse Graphical Layout Editor

Like `CheckBox`, the `ToggleButton` widget appears in the “Form Widgets” section of the Palette in the Graphical Layout editor. It looks like a button with the word “OFF” towards the top. You can drag it into the layout and configure it as desired using the Properties pane.

## Turn the Radio Up

As with other implementations of radio buttons in other toolkits, Android's radio buttons are two-state, like checkboxes, but can be grouped such that only one radio button in the group can be checked at any time.

Like `CheckBox`, `RadioButton` inherits from `CompoundButton`, which in turn inherits from `TextView`. Hence, all the standard `TextView` properties for font face, style, color, etc. are available for controlling the look of radio buttons. Similarly, you can call `isChecked()` on a `RadioButton` to see if it is selected, `toggle()` to change its checked state, and so on, like you can with a `CheckBox`.

Most times, you will want to put your `RadioButton` widgets inside of a `RadioGroup`. The `RadioGroup` is a `LinearLayout` that indicates a set of radio buttons whose state is tied, meaning only one button out of the group can be selected at any time. If you assign an `android:id` to your `RadioGroup` in your XML layout, you can access the group from your Java code and invoke:

1. `check()` to check a specific radio button via its ID (e.g., `group.check(R.id.radio1)`)
2. `clearCheck()` to clear all radio buttons, so none in the group are checked
3. `getCheckedRadioButtonId()` to get the ID of the currently-checked radio button (or `-1` if none are checked)

Note that the mutual-exclusion feature of `RadioGroup` only applies to `RadioButton` widgets that are immediate children of the `RadioGroup`. You cannot have other containers between the `RadioGroup` and its `RadioButton` widgets.

For example, from [the Basic/RadioButton sample application](#), here is an XML layout showing a `RadioGroup` wrapping a set of `RadioButton` widgets:

```
<?xml version="1.0" encoding="utf-8"?>
<RadioGroup
  xmlns:android="http://schemas.android.com/apk/res/android"
  android:orientation="vertical"
  android:layout_width="fill_parent"
  android:layout_height="fill_parent"
  >
  <RadioButton android:id="@+id/radio1"
    android:layout_width="wrap_content"
    android:layout_height="wrap_content"
    android:text="@string/rock" />
  <RadioButton android:id="@+id/radio2"
```

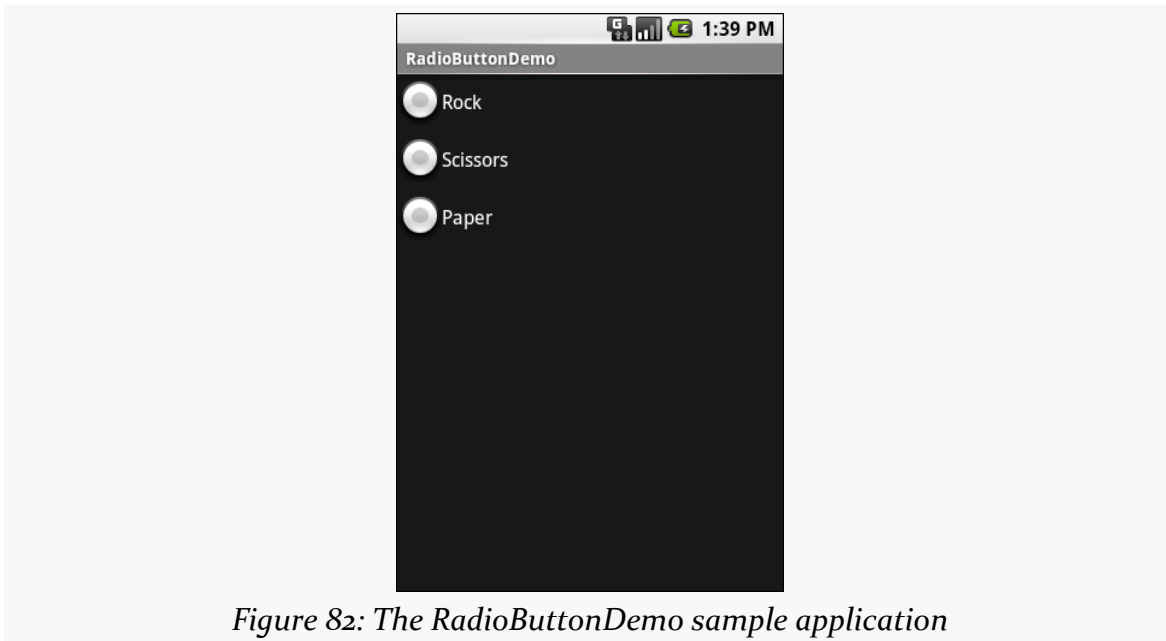
## OTHER COMMON WIDGETS AND CONTAINERS

---

```
android:layout_width="wrap_content"
android:layout_height="wrap_content"
android:text="@string/scissors" />

<RadioButton android:id="@+id/radio3"
android:layout_width="wrap_content"
android:layout_height="wrap_content"
android:text="@string/paper" />
</RadioGroup>
```

Using the stock Android-generated Java for the project and this layout, you get:



*Figure 82: The RadioButtonDemo sample application*

Note that the radio button group is initially set to be completely unchecked at the outset. To preset one of the radio buttons to be checked, use either `setChecked()` on the `RadioButton` or `check()` on the `RadioGroup` from within your `onCreate()` callback in your activity. Alternatively, you can use the `android:checked` attribute on one of the `RadioButton` widgets in the layout file.

### Eclipse Graphical Layout Editor

Both `RadioButton` and `RadioGroup` appear in the “Form Widgets” section of the Palette in the Graphical Layout editor. The `RadioButton` widget has a radio button with the text “`RadioButton`” to the right. The `RadioGroup` widget looks like three radio buttons (sans text) side-by-side.

Since `RadioGroup` extends `LinearLayout`, when you drag it into the layout, you will get the same sorts of options as a vertical `LinearLayout`, such as setting the gravity. Note, though, that dragging a `RadioGroup` into a layout automatically gives you three `RadioButton` child widgets — a departure from any other container in the Palette. You can configure those `RadioButton` widgets, delete them, add more, etc.

## All Things Are Relative

`RelativeLayout`, as the name suggests, lays out widgets based upon their relationship to other widgets in the container and the parent container. You can place Widget X below and to the left of Widget Y, or have Widget Z's bottom edge align with the bottom of the container, and so on.

This is reminiscent of James Elliot's [RelativeLayout](#) for use with Java/Swing.

## Concepts and Properties

To make all this work, we need ways to reference other widgets within an XML layout file, plus ways to indicate the relative positions of those widgets.

### Positions Relative to Container

The easiest relations to set up are tying a widget's position to that of its container:

1. `android:layout_alignParentTop` says the widget's top should align with the top of the container
2. `android:layout_alignParentBottom` says the widget's bottom should align with the bottom of the container
3. `android:layout_alignParentLeft` says the widget's left side should align with the left side of the container
4. `android:layout_alignParentRight` says the widget's right side should align with the right side of the container
5. `android:layout_centerHorizontal` says the widget should be positioned horizontally at the center of the container
6. `android:layout_centerVertical` says the widget should be positioned vertically at the center of the container
7. `android:layout_centerInParent` says the widget should be positioned both horizontally and vertically at the center of the container

All of these properties take a simple boolean value (true or false).

Note that the padding of the widget is taken into account when performing these various alignments. The alignments are based on the widget's overall cell (combination of its natural space plus the padding).

### Relative Notation in Properties

The remaining properties of relevance to `RelativeLayout` take as a value the identity of a widget in the container. To do this:

- Put identifiers (`android:id` attributes) on all elements that you will need to address
- Reference other widgets using the same identifier value

The first occurrence of an `id` value should have the plus sign (`@+id/widget_a`); the second and subsequent times that `id` value is used in the layout file should drop the plus sign (`@id/widget_a`). This allows the build tools to better help you catch typos in your widget `id` values — if you do not have a plus sign for a widget `id` value that has not been seen before, that will be caught at compile time.

For example, if Widget A appears in the `RelativeLayout` before Widget B, and Widget A is identified as `@+id/widget_a`, Widget B can refer to Widget A in one of its own properties via the identifier `@id/widget_a`.

### Positions Relative to Other Widgets

There are four properties that control position of a widget *vis-à-vis* other widgets:

1. `android:layout_above` indicates that the widget should be placed above the widget referenced in the property
2. `android:layout_below` indicates that the widget should be placed below the widget referenced in the property
3. `android:layout_toLeftOf` indicates that the widget should be placed to the left of the widget referenced in the property
4. `android:layout_toRightOf` indicates that the widget should be placed to the right of the widget referenced in the property

Beyond those four, there are five additional properties that can control one widget's alignment relative to another:

## OTHER COMMON WIDGETS AND CONTAINERS

---

1. `android:layout_alignTop` indicates that the widget's top should be aligned with the top of the widget referenced in the property
2. `android:layout_alignBottom` indicates that the widget's bottom should be aligned with the bottom of the widget referenced in the property
3. `android:layout_alignLeft` indicates that the widget's left should be aligned with the left of the widget referenced in the property
4. `android:layout_alignRight` indicates that the widget's right should be aligned with the right of the widget referenced in the property
5. `android:layout_alignBaseline` indicates that the baselines of the two widgets should be aligned (where the "baseline" is that invisible line that text appears to sit on)

The last one is useful for aligning labels and fields so that the text appears "natural". Since fields have a box around them and labels do not, `android:layout_alignTop` would align the top of the field's box with the top of the label, which will cause the text of the label to be higher on-screen than the text entered into the field.

So, if we want Widget B to be positioned to the right of Widget A, in the XML element for Widget B, we need to include `android:layout_toRightOf = "@id/widget_a"` (assuming `@id/widget_a` is the identity of Widget A).

### Order of Evaluation

It used to be that Android would use a single pass to process `RelativeLayout`-defined rules. That meant you could not reference a widget (e.g., via `android:layout_above`) until it had been declared in the XML. This made defining some layouts a bit complicated. Starting in Android 1.6, Android uses two passes to process the rules, so you can now safely have forward references to as-yet-undefined widgets.

### Example

With all that in mind, let's examine a typical "form" with a field, a label, plus a pair of buttons labeled "OK" and "Cancel".

Here is the XML layout, pulled from [the Containers/Relative sample project](#):

```
<?xml version="1.0" encoding="utf-8"?>
<RelativeLayout
  xmlns:android="http://schemas.android.com/apk/res/android"
  android:layout_width="fill_parent"
  android:layout_height="wrap_content">
```

```
<TextView
    android:id="@+id/label"
    android:layout_width="wrap_content"
    android:layout_height="wrap_content"
    android:layout_alignBaseline="@+id/entry"
    android:layout_alignParentLeft="true"
    android:text="@string/url"/>

<EditText
    android:id="@id/entry"
    android:layout_width="fill_parent"
    android:layout_height="wrap_content"
    android:layout_alignParentTop="true"
    android:layout_toRightOf="@id/label"
    android:inputType="text"/>

<Button
    android:id="@+id/ok"
    android:layout_width="wrap_content"
    android:layout_height="wrap_content"
    android:layout_alignRight="@id/entry"
    android:layout_below="@id/entry"
    android:text="@string/ok"/>

<Button
    android:id="@+id/cancel"
    android:layout_width="wrap_content"
    android:layout_height="wrap_content"
    android:layout_alignTop="@id/ok"
    android:layout_toLeftOf="@id/ok"
    android:text="@string/cancel"/>
```

```
</RelativeLayout>
```

First, we open up the `RelativeLayout`. In this case, we want to use the full width of the screen (`android:layout_width = "fill_parent"`) and only as much height as we need (`android:layout_height = "wrap_content"`).

Next, we define the label as a `TextView`. We indicate that we want its left edge aligned with the left edge of the `RelativeLayout` (`android:layout_alignParentLeft="true"`) and that we want its baseline aligned with the baseline of the yet-to-be-defined `EditText`. Since the `EditText` has not been declared yet, we use the + sign in the ID (`android:layout_alignBaseline="@+id/entry"`).

After that, we add in the field as an `EditText`. We want the field to be to the right of the label, have the field be aligned with the top of the `RelativeLayout`, and for the



## OTHER COMMON WIDGETS AND CONTAINERS

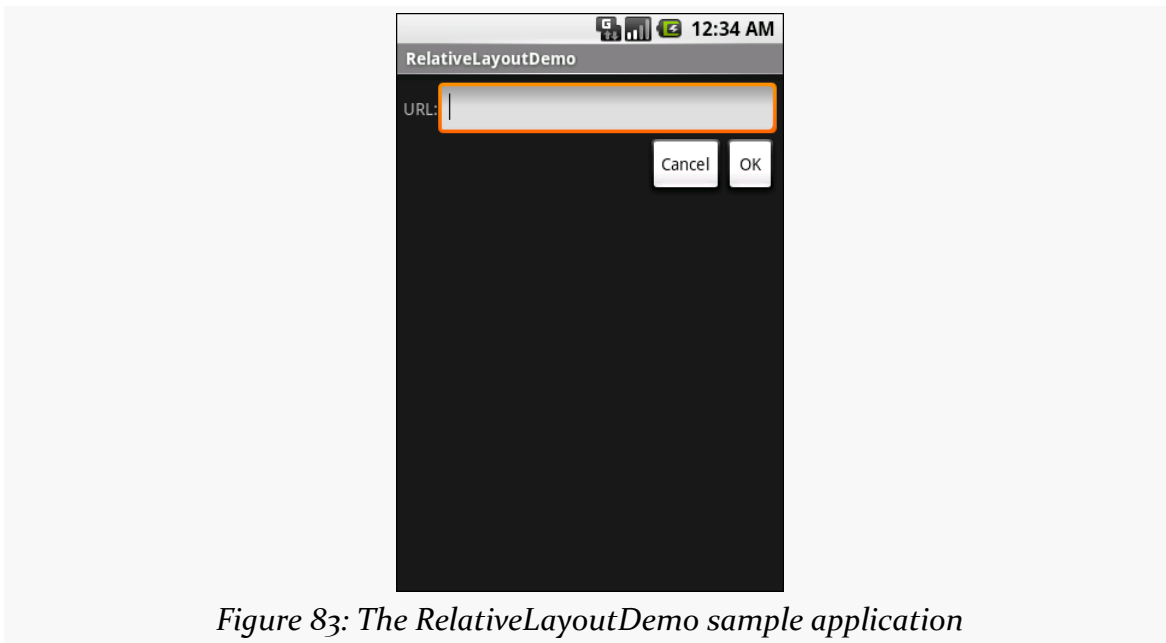
---

field to take up the rest of this “row” in the layout. Those are handled by three properties:

1. `android:layout_toRightOf = "@id/label"`
2. `android:layout_alignParentTop = "true"`
3. `android:layout_width = "fill_parent"`

Then, the OK button is set to be below the field (`android:layout_below = "@id/entry"`) and have its right side align with the right side of the field (`android:layout_alignRight = "@id/entry"`). The Cancel button is set to be to the left of the OK button (`android:layout_toLeft = "@id/ok"`) and have its top aligned with the OK button (`android:layout_alignTop = "@id/ok"`).

With no changes to the auto-generated Java code, the emulator gives us:



*Figure 83: The RelativeLayoutDemo sample application*

## Overlap

RelativeLayout also has a feature that LinearLayout lacks — the ability to have widgets overlap one another. Later children of a RelativeLayout are “higher in the Z axis” than are earlier children, meaning that later children will overlap earlier children if they are set up to occupy the same space in the layout.

## OTHER COMMON WIDGETS AND CONTAINERS

---

This will be clearer with an example. Here is a layout, [from the Containers/RelativeOverlap sample](#), with a RelativeLayout holding two Button widgets:

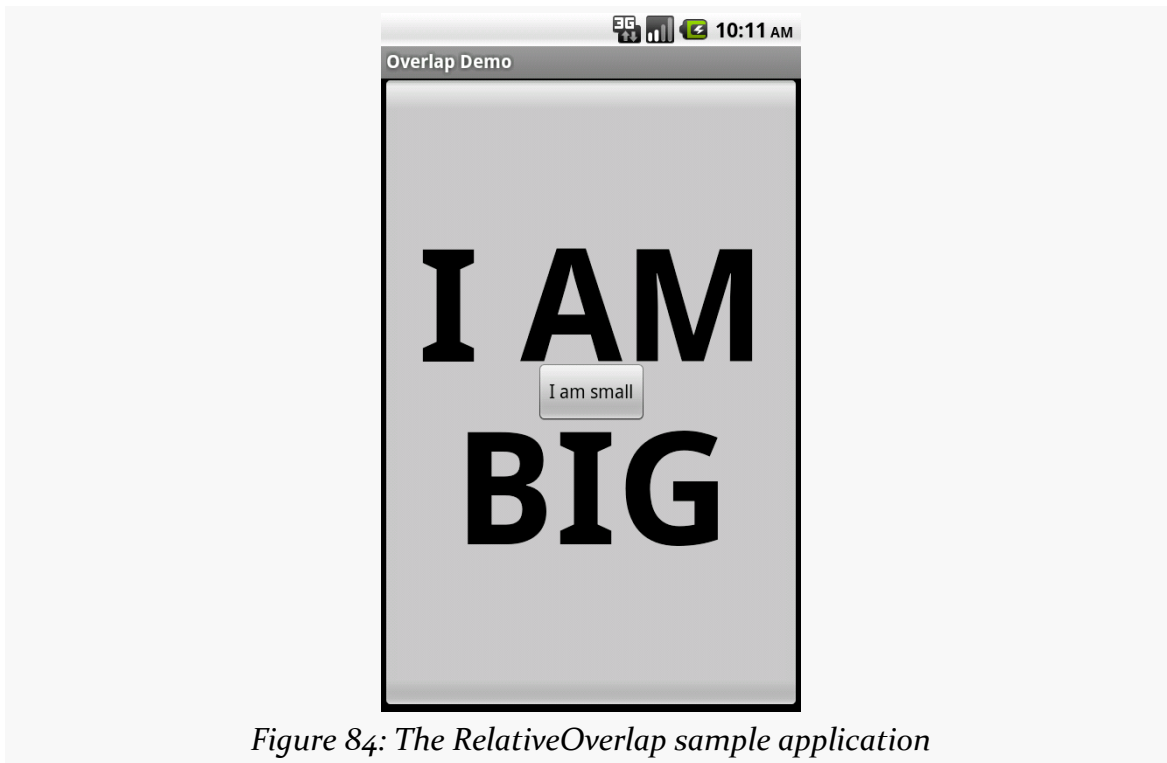
```
<?xml version="1.0" encoding="utf-8"?>
<RelativeLayout xmlns:android="http://schemas.android.com/apk/res/android"
    android:layout_width="fill_parent"
    android:layout_height="fill_parent">

    <Button
        android:layout_width="fill_parent"
        android:layout_height="fill_parent"
        android:text="@string/big"
        android:textSize="120dip"
        android:textStyle="bold"/>

    <Button
        android:layout_width="wrap_content"
        android:layout_height="wrap_content"
        android:layout_centerInParent="true"
        android:text="@string/small"/>

</RelativeLayout>
```

The first Button is set to fill the screen. The second Button is set to be centered inside the parent, but only take up as much space as is needed for its caption. Hence, the second Button will appear to “float” over the first Button:



*Figure 84: The RelativeLayout sample application*

Both Button widgets can still be clicked, though clicking on the smaller Button does not also click the bigger Button. Your clicks will be handled by the widget on top in the case of an overlap like this.

### **Eclipse Graphical Layout Editor**

You will find RelativeLayout in the “Layouts” section of the Palette in the Eclipse Graphical Layout editor. You can drag that into your layout XML resource.

And, at this point, you can start getting frustrated. To paraphrase an old American candy commercial, drag-and-drop GUI building and RelativeLayout are two great tastes that do not taste great together.

The problem is that the complexity of the RelativeLayout rules makes it very difficult for the Graphical Layout editor to guess what you really mean when you drag a widget into the RelativeLayout. It will guess as best it can — for example, if you are dropping the widget near the edge of the RelativeLayout, it will assume you mean for the widget to be aligned with that edge. However, frequently, it will guess wrong, forcing you to modify the RelativeLayout XML directly via the other editor sub-tab or via the Properties pane to get the rules that you want.

## Tabula Rasa

If you like HTML tables, you will like Android's `TableLayout` — it allows you to position your widgets in a grid to your specifications. You control the number of rows and columns, which columns might shrink or stretch to accommodate their contents, and so on.

`TableLayout` works in conjunction with `TableRow`. `TableLayout` controls the overall behavior of the container, with the widgets themselves poured into one or more `TableRow` containers, one per row in the grid.

### Concepts and Properties

For all this to work, we need to figure out how widgets work with rows and columns, plus how to handle widgets that live outside of rows.

#### Putting Cells in Rows

Rows are declared by you, the developer, by putting widgets as children of a `TableRow` inside the overall `TableLayout`. You, therefore, control directly how many rows appear in the table.

The number of columns are determined by Android; you control the number of columns in an indirect fashion.

First, there will be at least one column per widget in your longest row. So if you have three rows, one with two widgets, one with three widgets, and one with four widgets, there will be at least four columns.

However, a widget can take up more than one column by including the `android:layout_span` property, indicating the number of columns the widget spans. This is akin to the `colspan` attribute one finds in table cells in HTML:

```
<TableRow>
  <TextView android:text="URL:" />
  <EditText
    android:id="@+id/entry"
    android:layout_span="3"/>
</TableRow>
```

In the above XML layout fragment, the field spans three columns.

Ordinarily, widgets are put into the first available column. In the above fragment, the label would go in the first column (column 0, as columns are counted starting from 0), and the field would go into a spanned set of three columns (columns 1 through 3). However, you can put a widget into a different column via the `android:layout_column` property, specifying the 0-based column the widget belongs to:

```
<TableRow>
  <Button
    android:id="@+id/cancel"
    android:layout_column="2"
    android:text="Cancel" />
  <Button android:id="@+id/ok" android:text="OK" />
</TableRow>
```

In the preceding XML layout fragment, the Cancel button goes in the third column (column 2). The OK button then goes into the next available column, which is the fourth column.

### Non-Row Children of `TableLayout`

Normally, `TableLayout` contains only `TableRow` elements as immediate children. However, it is possible to put other widgets in between rows. For those widgets, `TableLayout` behaves a bit like `LinearLayout` with vertical orientation. The widgets automatically have their width set to `fill_parent`, so they will fill the same space that the longest row does.

One pattern for this is to use a plain `View` as a divider (e.g., `<View android:layout_height = "2dip" android:background = "#0000FF" />` as a two-pixel-high blue bar across the width of the table).

### Stretch, Shrink, and Collapse

By default, each column will be sized according to the “natural” size of the widest widget in that column (taking spanned columns into account). Sometimes, though, that does not work out very well, and you need more control over column behavior.

You can place an `android:stretchColumns` property on the `TableLayout`. The value should be a single column number (again, 0-based) or a comma-delimited list of column numbers. Those columns will be stretched to take up any available space yet on the row. This helps if your content is narrower than the available space.

Conversely, you can place an `android:shrinkColumns` property on the `TableLayout`. Again, this should be a single column number or a comma-delimited list of column numbers. The columns listed in this property will try to word-wrap their contents to reduce the effective width of the column — by default, widgets are not word-wrapped. This helps if you have columns with potentially wordy content that might cause some columns to be pushed off the right side of the screen.

You can also leverage an `android:collapseColumns` property on the `TableLayout`, again with a column number or comma-delimited list of column numbers. These columns will start out “collapsed”, meaning they will be part of the table information but will be invisible. Programmatically, you can collapse and un-collapse columns by calling `setColumnCollapsed()` on the `TableLayout`. You might use this to allow users to control which columns are of importance to them and should be shown versus which ones are less important and can be hidden.

You can also control stretching and shrinking at runtime via `setColumnStretchable()` and `setColumnShrinkable()`.

### Example

The XML layout fragments shown above, when combined, give us a `TableLayout` rendition of the “form” we created for `RelativeLayout`, with the addition of a divider line between the label/field and the two buttons (found in [the Containers/Table demo](#)):

```
<?xml version="1.0" encoding="utf-8"?>
<TableLayout xmlns:android="http://schemas.android.com/apk/res/android"
    android:layout_width="fill_parent"
    android:layout_height="fill_parent"
    android:stretchColumns="1">

    <TableRow>
        <TextView android:text="@string/url"/>
        <EditText
            android:id="@+id/entry"
            android:layout_span="3"
            android:inputType="text"/>
    </TableRow>

    <View
        android:layout_height="2dip"
        android:background="#0000FF"/>

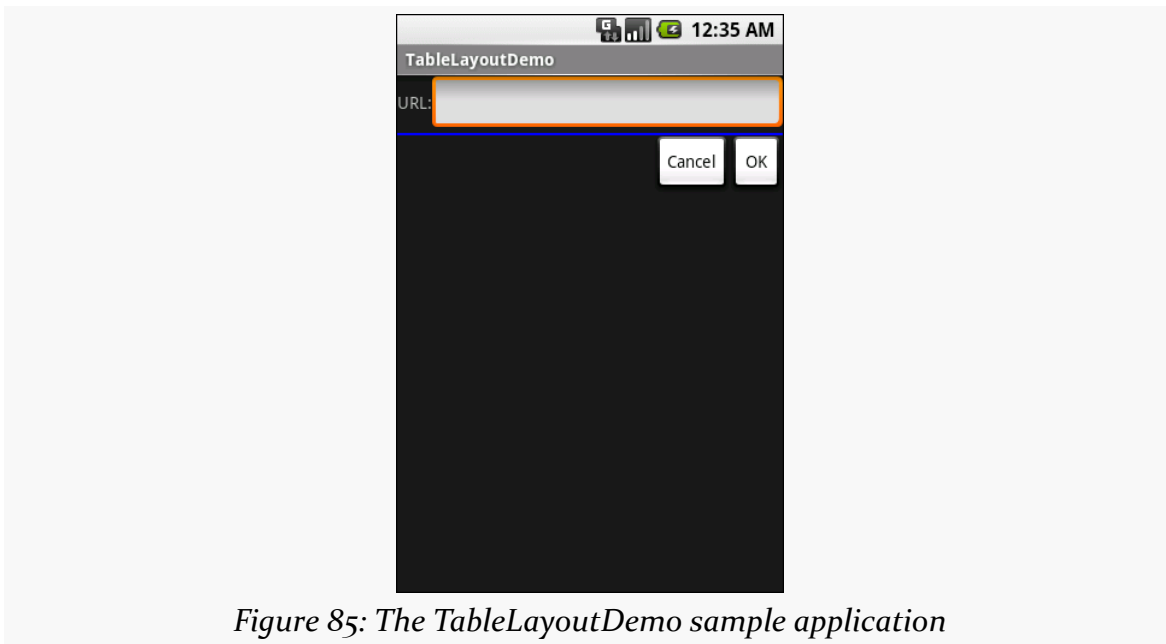
    <TableRow>
        <Button
            android:id="@+id/cancel"
```

## OTHER COMMON WIDGETS AND CONTAINERS

---

```
        android:layout_column="2"
        android:text="@string/cancel"/>
    <Button
        android:id="@+id/ok"
        android:text="@string/ok"/>
</TableRow>
</TableLayout>
```

When compiled against the generated Java code and run on the emulator, we get:

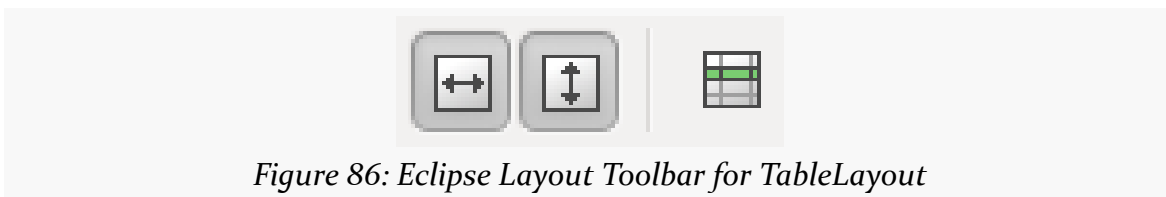


*Figure 85: The TableLayoutDemo sample application*

## Eclipse Graphical Layout Editor

You will find TableLayout in the “Layouts” section of the Palette in the Eclipse Graphical Layout editor. You can drag that into your layout XML resource and start configuring it via the context menu, notably editing the `android:stretchColumns` and `android:shrinkColumns` values.

In addition, the toolbar above the layout will now sport an add-row button:



*Figure 86: Eclipse Layout Toolbar for TableLayout*





## OTHER COMMON WIDGETS AND CONTAINERS

---

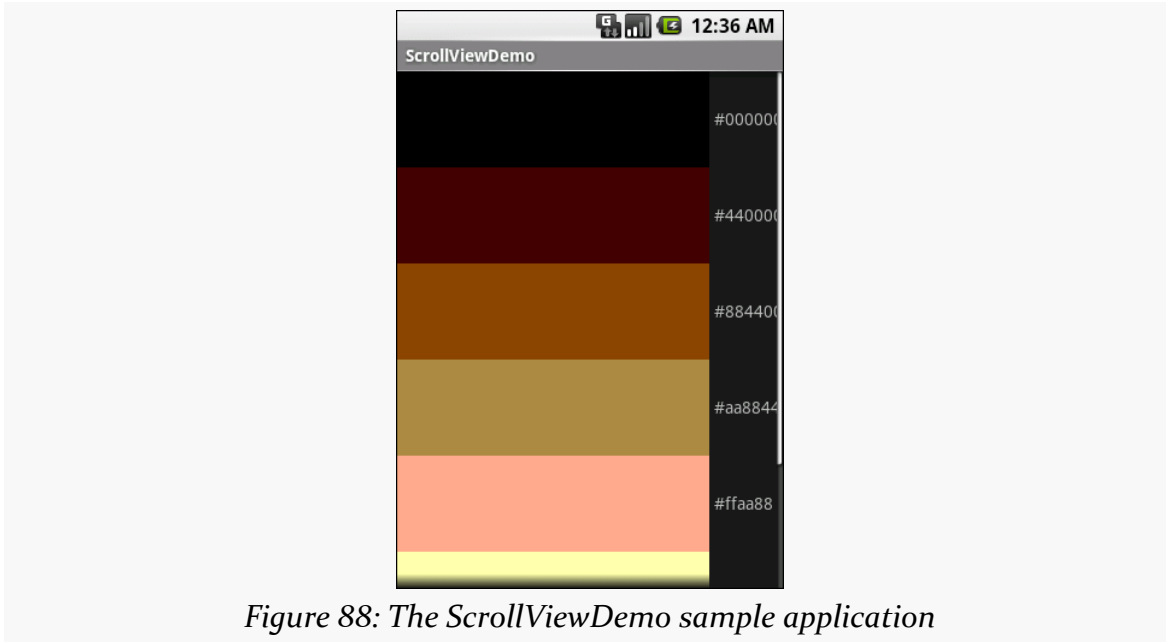
```
<TextView android:text="#000000"
    android:paddingLeft="4dip"
    android:layout_gravity="center_vertical" />
</TableRow>
<TableRow>
    <View
        android:layout_height="80dip"
        android:background="#440000" />
    <TextView android:text="#440000"
        android:paddingLeft="4dip"
        android:layout_gravity="center_vertical" />
</TableRow>
<TableRow>
    <View
        android:layout_height="80dip"
        android:background="#884400" />
    <TextView android:text="#884400"
        android:paddingLeft="4dip"
        android:layout_gravity="center_vertical" />
</TableRow>
<TableRow>
    <View
        android:layout_height="80dip"
        android:background="#aa8844" />
    <TextView android:text="#aa8844"
        android:paddingLeft="4dip"
        android:layout_gravity="center_vertical" />
</TableRow>
<TableRow>
    <View
        android:layout_height="80dip"
        android:background="#ffaa88" />
    <TextView android:text="#ffaa88"
        android:paddingLeft="4dip"
        android:layout_gravity="center_vertical" />
</TableRow>
<TableRow>
    <View
        android:layout_height="80dip"
        android:background="#ffffaa" />
    <TextView android:text="#ffffaa"
        android:paddingLeft="4dip"
        android:layout_gravity="center_vertical" />
</TableRow>
<TableRow>
    <View
        android:layout_height="80dip"
        android:background="#ffffff" />
    <TextView android:text="#ffffff"
        android:paddingLeft="4dip"
        android:layout_gravity="center_vertical" />
</TableRow>
</TableLayout>
</ScrollView>
```

## OTHER COMMON WIDGETS AND CONTAINERS

---

Without the `ScrollView`, the table would take up at least 560 pixels (7 rows at 80 pixels each, based on the `View` declarations). There may be some devices with screens capable of showing that much information, but many will be smaller. The `ScrollView` lets us keep the table as-is, but only present part of it at a time.

On the stock Android emulator, when the activity is first viewed, you see:



*Figure 88: The ScrollViewDemo sample application*

Notice how only five rows and part of the sixth are visible. By pressing the up/down buttons on the directional pad, you can scroll up and down to see the remaining rows. Also note how the right side of the content gets clipped by the scrollbar — be sure to put some padding on that side or otherwise ensure your own content does not get clipped in that fashion.

Android 1.5 introduced `HorizontalScrollView`, which works like `ScrollView`... just horizontally. This would be good for forms that might be too wide rather than too tall. Note that `ScrollView` only scrolls vertically and `HorizontalScrollView` only scrolls horizontally.

Also, note that you cannot put scrollable items into a `ScrollView`. For example, a `ListView` widget — which we will see in [an upcoming chapter](#) — already knows how to scroll. You do not need to put a `ListView` in a `ScrollView`, and if you were to try, it would not work very well.

## Eclipse Graphical Layout Editor

The `ScrollView` and `HorizontalScrollView` widgets appear in the “Composite” section of the Palette in the Graphical Layout editor. You can drag one of these into your layout XML resource, then drag *one* child into it. A `ScrollView` or `HorizontalScrollView` can only have one child — if you want more than one, wrap the children in a suitable `LinearLayout` and put that inside the `ScrollView` or `HorizontalScrollView`.

## Making Progress with ProgressBars

If you are going to fork background threads to do work on behalf of the user, you will want to think about keeping the user informed that work is going on. This is particularly true if the user is effectively waiting for that background work to complete.

The typical approach to keeping users informed of progress is some form of progress bar, like you see when you copy a bunch of files from place to place in many desktop operating systems. Android supports this through the `ProgressBar` widget.

A `ProgressBar` keeps track of progress, defined as an integer, with 0 indicating no progress has been made. You can define the maximum end of the range — what value indicates progress is complete — via `setMax()`. By default, a `ProgressBar` starts with a progress of 0, though you can start from some other position via `setProgress()`.

If you prefer your progress bar to be indeterminate — meaning that it will show a general animated effect, rather than a specific amount of progress – use `setIndeterminate()`, setting it to true.

In your Java code, you can either positively set the amount of progress that has been made (via `setProgress()`) or increment the progress from its current amount (via `incrementProgressBy()`). You can find out how much progress has been made via `getProgress()`.

We will see a `ProgressBar` in action in [the next chapter](#), another one of our tutorials.

## Visit the Trails!

The trails portion of the book contains [a widget catalog](#), providing capsule descriptions and samples for a number of widgets not described elsewhere in this book.

You might also be interested in [GridLayout](#), which is an alternative to the classic `LinearLayout`, `RelativeLayout`, and `TableLayout` containers.



# Tutorial #5 - Making Progress

---

When we actually get around to opening the digital book for display, there will be a slight delay as the HTML and other assets are read into memory. To help assure the user that their device has not frozen, we will add a `ProgressBar` to our user interface in this tutorial.

This is a continuation of the work we did in [the previous tutorial](#).

You can find [the results of the previous tutorial](#) and [the results of this tutorial](#) in [the book's GitHub repository](#).

## Step #1: Removing The “Hello, World”

Right now, our user interface consists of a highly-sophisticated “Hello, World” string, shown in a `TextView`. While no doubt it is eligible for many design awards, this is not the user interface we need. So, we need to get rid of it.

If you wish to make this change using Eclipse’s wizards and tools, follow the instructions in the “Eclipse” section below. Otherwise, follow the instructions in the “Outside of Eclipse” section (appears after the “Eclipse” section).

### Eclipse

Double-click on the `res/layout/main.xml` file in your project in Eclipse’s Package Explorer. This will bring up our current user interface:

## TUTORIAL #5 - MAKING PROGRESS

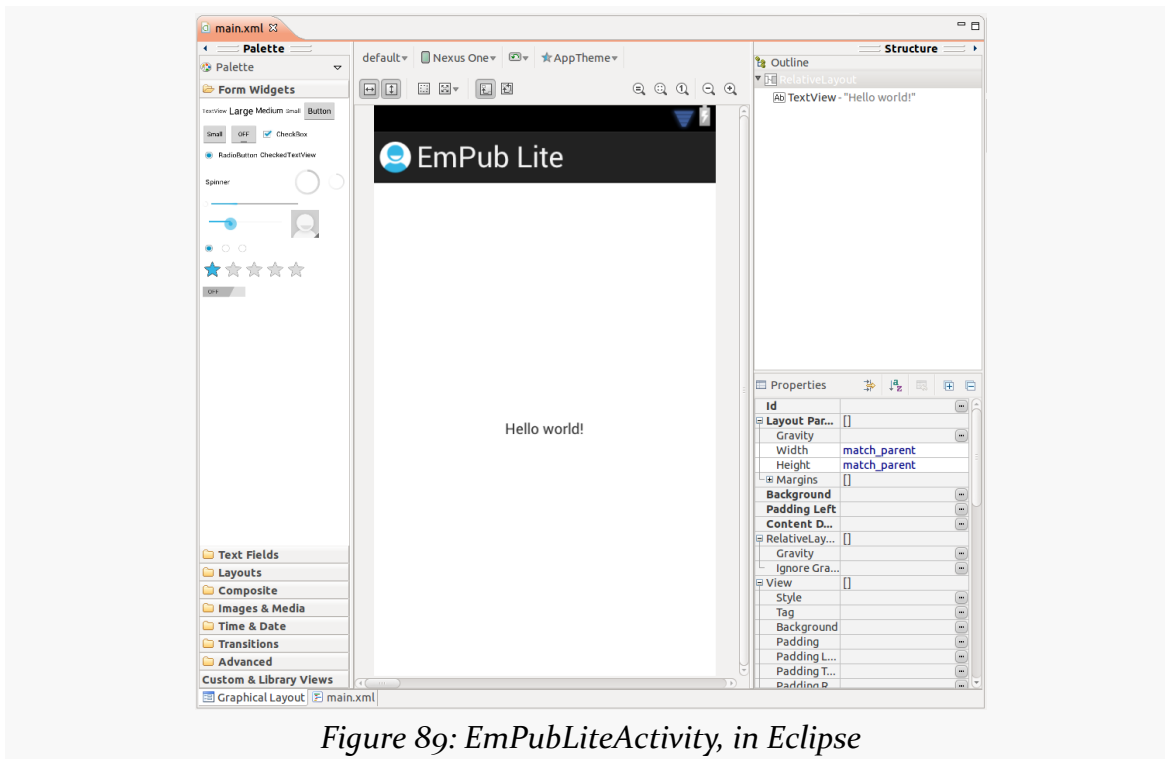


Figure 89: *EmPubLiteActivity*, in Eclipse

Click on the “Hello World!” string, then press the <Delete> key. You can now save your file (e.g., <Ctrl>-<S>).

Also, we no longer need the `hello_world` string resource. To remove it, double-click on the `res/values/strings.xml` file, select the `hello_world` string resource, click the “Remove...” button, click “Yes” on the confirmation dialog, and save the resulting file.

### Outside of Eclipse

Open `res/layout/main.xml` in your favorite text editor. Find and delete the <TextView> element, then save the file.

The resulting XML should look like:

```
<RelativeLayout xmlns:android="http://schemas.android.com/apk/res/android"
    xmlns:tools="http://schemas.android.com/tools"
    android:layout_width="match_parent"
    android:layout_height="match_parent"
    tools:context=".EmPubLiteActivity">

</RelativeLayout>
```

## TUTORIAL #5 - MAKING PROGRESS

---

Also, we no longer need the `hello_world` string resource. To remove it, open the `res/values/strings.xml` file in your favorite text editor. Find the `<string>` element that has a name of `hello_world`, delete that element, and save the file.

The resulting XML should look like:

```
<?xml version="1.0" encoding="utf-8"?>
<resources>

  <string name="app_name">EmPub Lite</string>
  <string name="menu_settings">Settings</string>

</resources>
```

### Step #2: Adding a ProgressBar

Now that the `TextView` is out of the way, we can add our `ProgressBar` in its place.

If you wish to make this change using Eclipse's wizards and tools, follow the instructions in the "Eclipse" section below. Otherwise, follow the instructions in the "Outside of Eclipse" section (appears after the "Eclipse" section).

#### Eclipse

Go back to `res/layout/main.xml` in Eclipse. In the "Form Widgets" portion of the tool palette, you will see three `ProgressBar` widget representations, in the form of circles:



## TUTORIAL #5 - MAKING PROGRESS

---

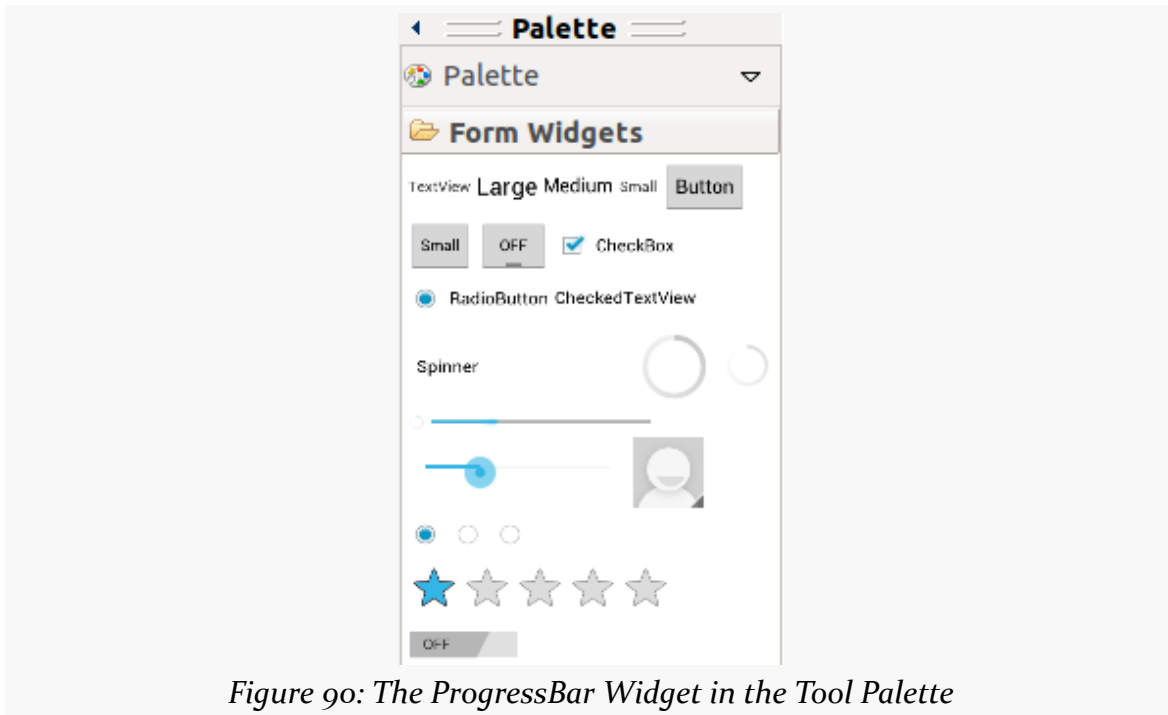


Figure 90: The ProgressBar Widget in the Tool Palette

Drag the largest one out of the palette and onto the preview of our activity. You will see a tooltip pointing out the RelativeLayout rules that the drag-and-drop operation will apply if you drop the widget in its current location. Slide the ProgressBar around until you center it and the tooltip shows that it will use `android:layout_centerHorizontal="true"` and `android:layout_centerVertical="true"`. If you wind up with `android:layout_centerInParent="true"` instead of those other two settings, that is fine as well.

If you are having difficulty centering it, drop it anywhere in the white part of the preview area. Then, from the toolbar above the preview, press the center-horizontal and center-vertical toolbar buttons in succession:

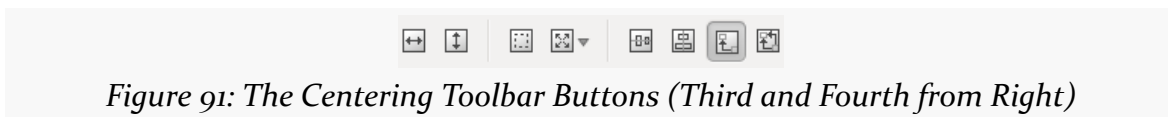


Figure 91: The Centering Toolbar Buttons (Third and Fourth from Right)

Then, you can save your file.

### Outside of Eclipse

Go back to `res/layout/main.xml` in your favorite text editor. Delete the `<TextView>` element that was there. Replace it with a `<ProgressBar>` element as a child of the `<RelativeLayout>`, as shown below:

```
<RelativeLayout xmlns:android="http://schemas.android.com/apk/res/android"
    xmlns:tools="http://schemas.android.com/tools"
    android:layout_width="match_parent"
    android:layout_height="match_parent"
    tools:context=".EmPubLiteActivity">

    <ProgressBar
        android:id="@+id/progressBar1"
        style="?android:attr/progressBarStyleLarge"
        android:layout_width="wrap_content"
        android:layout_height="wrap_content"
        android:layout_centerHorizontal="true"
        android:layout_centerVertical="true"/>

</RelativeLayout>
```

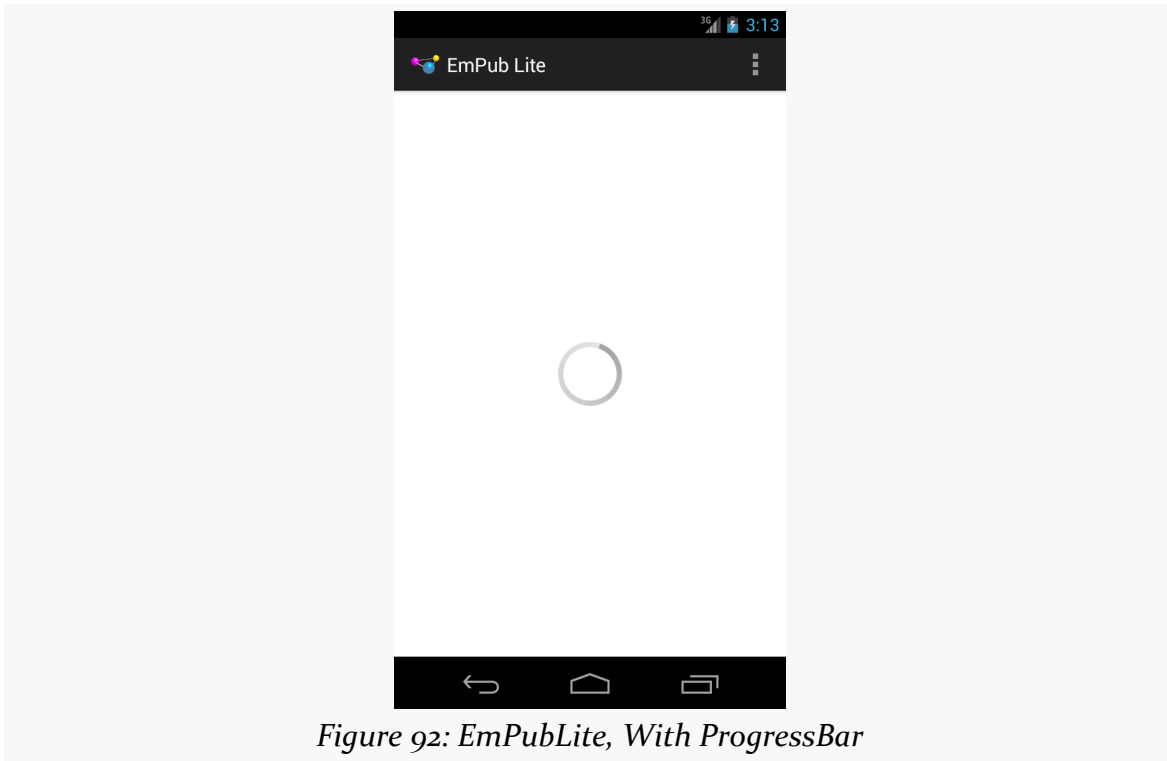
Then, you can save your file.

### Step #3: Seeing the Results

If you run the app in a device or emulator, you will see your `ProgressBar` widget, sitting there, all alone, waiting for somebody to write more code in support of it:

## TUTORIAL #5 - MAKING PROGRESS

---



*Figure 92: EmPubLite, With ProgressBar*

### In Our Next Episode...

... we will [attach a third-party library](#) to our tutorial project.

# GUI Building, Continued

---

If you are using Eclipse, and you have been experimenting with the Graphical Layout editor and drag-and-drop GUI building, this chapter will cover some other general features of this editor that you may find useful.

Even if you are not using Eclipse, you may want to at least skim this chapter, as you will find a few tricks that will be relevant for you as well.

## Making Your Selection

Clicking on a widget makes it the selected widget, meaning that the toolbar buttons will affect that widget (or, sometimes, its container, depending upon the button). Selected widgets have a thin blue border with blue square “grab handles” for adjusting its size and position.

Clicking on a container makes it be selected. However, there may or may not be a blue border — in particular, containers that fill the screen (`fill_parent` for width and height) do not seem to get the border.

Sometimes, though, you want to select a container that you cannot reach, because its contents are completely filled with widgets. That occurs with the `LinearPercent` sample from [a previous chapter](#) – the entire `LinearLayout` is filled with the three `Button` widgets. In these cases, click on the widget in the Outline pane to select it.

## Including Includes

Sometimes, you have a widget or a collection of widgets that you want to reuse across multiple layout XML resources. Android supports the notion of an “include”

## GUI BUILDING, CONTINUED

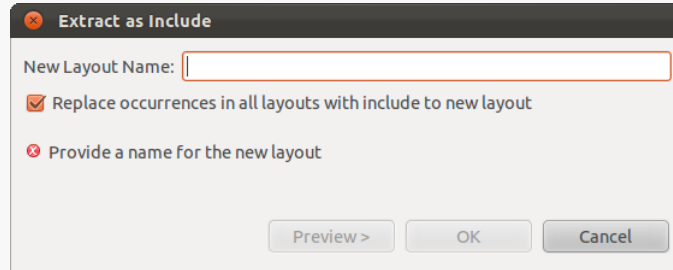
---

that allows this. Simply create a dedicated layout XML resource that contains the widget(s) to reuse, then add them to your main layouts via an `<include>` element:

```
<include layout="@layout/thing_we_are_reusing" />
```

You can even assign the `<include>` element a width or height if needed, as if it were just a widget or container.

Eclipse makes it easy for you to take widgets from an existing layout XML resource and extract them into a separate layout XML resource, replacing them with an `<include>` element. Just select the widget(s) you want to reuse, then right-click over them and choose “Extract Include” from the context menu. This will bring up a dialog where you can specify a name to give the new layout XML resource:



*Figure 93: Extract as Include Dialog*

By default, the tools will search *all* your layout files for these widgets and replace them with the `<include>`, though you can uncheck the checkbox to disable this behavior and only affect the layout XML resource you are presently editing.

If you are extracting multiple widgets that are not wrapped in their own container, Eclipse will automatically wrap them in a `<merge>` element:

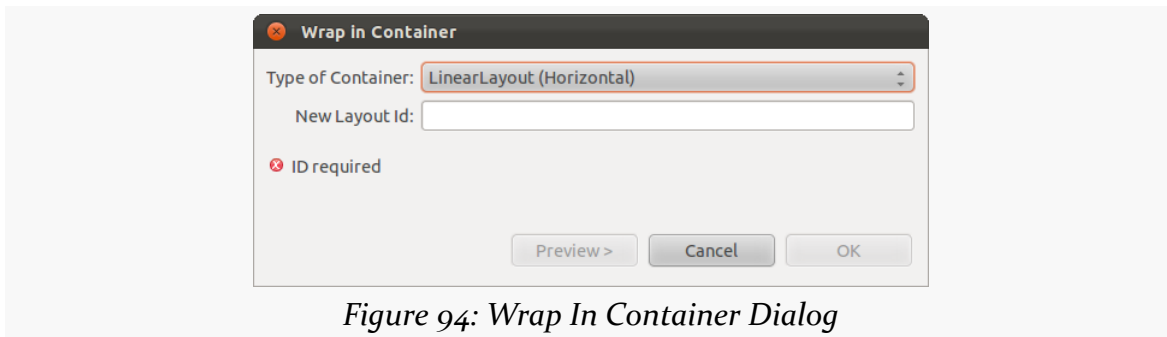
```
<?xml version="1.0" encoding="utf-8"?>
<merge xmlns:android="http://schemas.android.com/apk/res/android">
  <!-- widgets go here -->
</merge>
```

This is necessary purely from an XML standpoint — you cannot have multiple root elements in an XML file. When the `<merge>` is added to another layout via `<include>`, the `<merge>` element itself evaporates, leaving behind its children.

## Wrap It Up (In a Container)

Sometimes, after you have added a widget to your layout, you later determine that you really needed it to be in some sort of container. For example, perhaps you thought you only needed one `TextView` but later decided to stack two `TextView` widgets in a vertical `LinearLayout`, in which case you somehow need to introduce this `LinearLayout` into the mix.

The simplest way to do that is to right-click over the widget that needs a new container (in the preview pane or the Outline pane) and choose “Wrap In Container...” from the context menu. This will bring up a dialog allowing you to choose the class of the container (with a reasonable default pre-selected) and give the container an `android:id` value (which, for some strange reason, is mandatory).



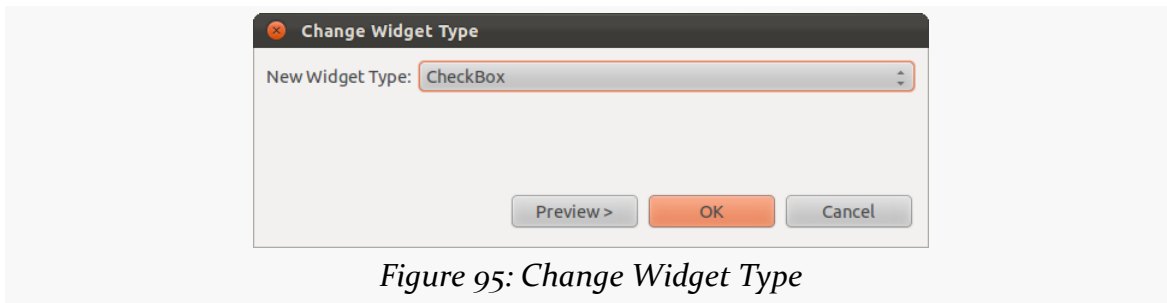
*Figure 94: Wrap In Container Dialog*

Similarly, if a widget is wrapped in a container, where the container is no longer necessary, “Remove Container” will get rid of the container.

## Morphing Widgets

Occasionally, you might configure a widget, only to decide later on that you really want it to be a different type of widget. For example, perhaps you start with a `CheckBox` and later want to switch it to be a `ToggleButton`.

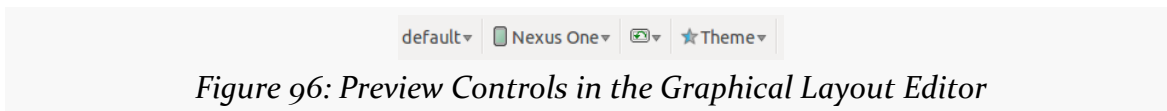
To do this, right-click over the widget in Eclipse (in the preview pane or the Outline pane) and choose “Change Widget Type” from the context menu. This will bring up a dialog box for you to choose a replacement widget class, with a likely candidate pre-selected for you:



After making the selection, Eclipse will alter your element to the new widget type. Note that you may need to make other changes yourself, for attributes that you no longer need or now need to add.

## Preview of Coming Attractions

At the top of the Graphical Layout editor tab, you will find a series of drop-downs that allow you to tailor what the preview looks like:



Eclipse will choose some likely defaults based upon your project settings, but you are welcome to change them as you see fit. Notable changes include:

- What version of Android is used for the preview (as widget styling changes from time to time in Android releases)
- What language is used for your string resources?
- What size and resolution of screen is used?
- Is it displayed in portrait or landscape?

These only affect the preview, so they show you (approximately) what your layout will look like under those conditions, but they do not modify anything about your layout XML itself.

# AdapterViews and Adapters

---

If you want the user to choose something out of a collection of somethings, you could use a bunch of `RadioButton` widgets. However, Android has a series of more flexible widgets than that, ones that this book will refer to as “selection widgets”.

These include:

- `ListView`, which is your typical “list box”
- `Spinner`, which (more or less) is a drop-down list
- `GridView`, offering a two-dimensional roster of choices
- `ExpandableListView`, a limited “tree” widget, supporting two levels in the hierarchy
- `Gallery`, a horizontal-scrolling list, principally used for image thumbnails

and many more.

Eclipse users will find these mostly in the “Composite” portion of the Graphical Layout editor palette, though `Spinner` is in the “Form Widgets” section and `Gallery` is in “Images & Media”.

These all have a common superclass: `AdapterView`, so named because they partner with objects implementing the `Adapter` interface to determine what choices are available for the user to choose from.

## Adapting to the Circumstances

In the abstract, adapters provide a common interface to multiple disparate APIs. More specifically, in Android’s case, adapters provide a common interface to the data model behind a selection-style widget, such as a listbox. This use of Java interfaces is



fairly common (e.g., Java/Swing's model adapters for `JTable`), and Java is far from the only environment offering this sort of abstraction (e.g., Flex's XML data-binding framework accepts XML inlined as static data or retrieved from the Internet).

Android's adapters are responsible for providing the roster of data for a selection widget plus converting individual elements of data into specific views to be displayed inside the selection widget. The latter facet of the adapter system may sound a little odd, but in reality it is not that different from other GUI toolkits' ways of overriding default display behavior. For example, in Java/Swing, if you want a `JList`-backed listbox to actually be a checklist (where individual rows are a checkbox plus label, and clicks adjust the state of the checkbox), you inevitably wind up calling `setCellRenderer()` to supply your own `ListCellRenderer`, which in turn converts strings for the list into `JCheckBox`-plus-`JLabel` composite widgets.

### Using ArrayAdapter

The easiest adapter to use is `ArrayAdapter` — all you need to do is wrap one of these around a Java array or `java.util.List` instance, and you have a fully-functioning adapter:

```
String[] items={"this", "is", "a", "really", "silly", "list"};
new ArrayAdapter<String>(this,
                        android.R.layout.simple_list_item_1,
                        items);
```

One flavor of the `ArrayAdapter` constructor takes three parameters:

1. The `Context` to use (typically this will be your activity instance)
2. The resource ID of a view to use (such as a built-in system resource ID, as shown above)
3. The actual array or list of items to show

By default, the `ArrayAdapter` will invoke `toString()` on the objects in the list and wrap each of those strings in the view designated by the supplied resource. `android.R.layout.simple_list_item_1` simply turns those strings into `TextView` objects. Those `TextView` widgets, in turn, will be shown in the list or spinner or whatever widget uses this `ArrayAdapter`. If you want to see what `android.R.layout.simple_list_item_1` looks like, you can find a copy of it in your SDK installation — just search for `simple_list_item_1.xml`.

We will see in a [later section](#) how to subclass an `Adapter` and override row creation, to give you greater control over how rows and cells appear.

## Lists of Naughty and Nice

The classic listbox widget in Android is known as `ListView`. Include one of these in your layout, invoke `setAdapter()` to supply your data and child views, and attach a listener via `setOnItemSelectedListener()` to find out when the selection has changed. With that, you have a fully-functioning listbox.

However, if your activity is dominated by a single list, you might well consider creating your activity as a subclass of `ListActivity`, rather than the regular `Activity` base class. If your main view is just the list, you do not even need to supply a layout — `ListActivity` will construct a full-screen list for you. If you do want to customize the layout, you can, so long as you identify your `ListView` as `@android:id/list`, so `ListActivity` knows which widget is the main list for the activity.

For example, here is a layout pulled from [the Selection/List sample project](#):

```
<?xml version="1.0" encoding="utf-8"?>
<LinearLayout
  xmlns:android="http://schemas.android.com/apk/res/android"
  android:orientation="vertical"
  android:layout_width="fill_parent"
  android:layout_height="fill_parent" >
  <TextView
    android:id="@+id/selection"
    android:layout_width="fill_parent"
    android:layout_height="wrap_content"/>
  <ListView
    android:id="@android:id/list"
    android:layout_width="fill_parent"
    android:layout_height="fill_parent"
    />
</LinearLayout>
```

It is just a list with a label on top to show the current selection.

The Java code to configure the list and connect the list with the label is:

```
package com.commonware.android.list;

import android.app.ListActivity;
import android.os.Bundle;
import android.view.View;
import android.widget.AdapterView;
import android.widget.AdapterView.OnItemClickListener;
import android.widget.ArrayAdapter;
import android.widget.ListView;
import android.widget.TextView;
```

## ADAPTERVIEWS AND ADAPTERS

---

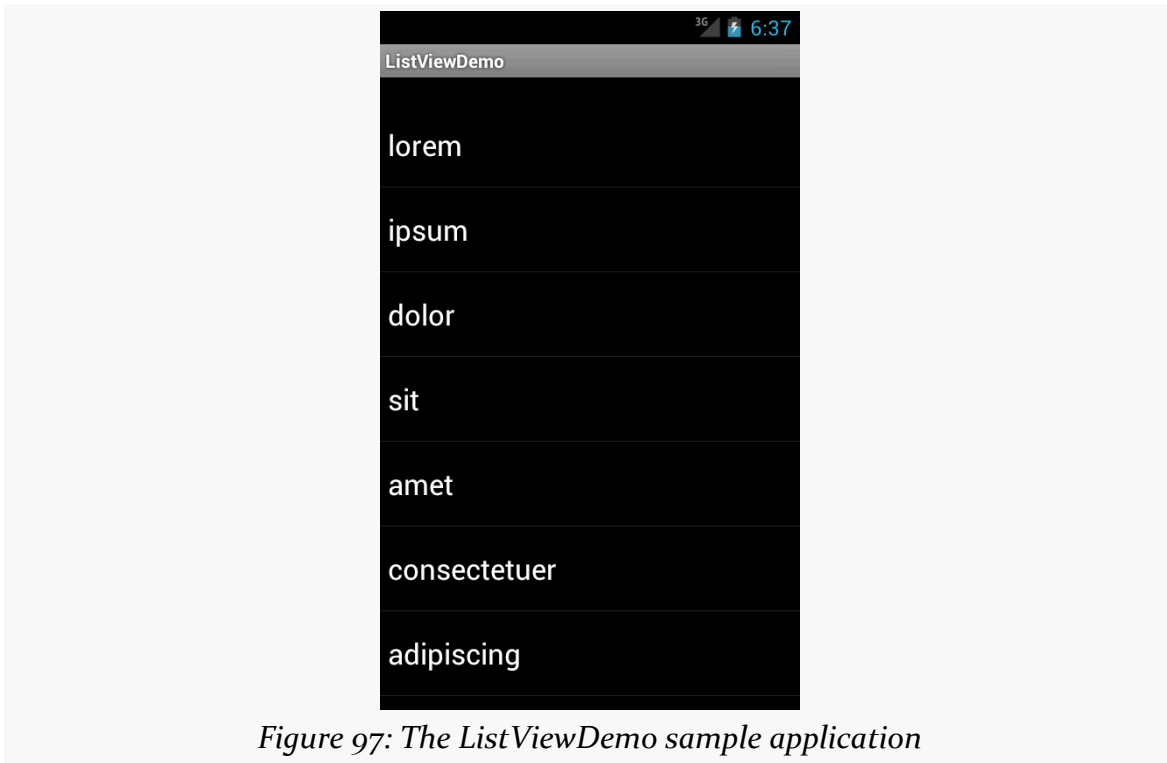
```
public class ListViewDemo extends ListActivity {
    private TextView selection;
    private static final String[] items={"lorem", "ipsum", "dolor",
        "sit", "amet",
        "consectetuer", "adipiscing", "elit", "morbi", "vel",
        "ligula", "vitae", "arcu", "aliquet", "mollis",
        "etiam", "vel", "erat", "placerat", "ante",
        "porttitor", "sodales", "pellentesque", "augue", "purus"};

    @Override
    public void onCreate(Bundle icle) {
        super.onCreate(icle);
        setContentView(R.layout.main);
        setListAdapter(new ArrayAdapter<String>(this,
            android.R.layout.simple_list_item_1,
            items));
        selection=(TextView)findViewById(R.id.selection);
    }

    @Override
    public void onItemClick(ListView parent, View v, int position,
        long id) {
        selection.setText(items[position]);
    }
}
```

With `ListActivity`, you can set the list adapter via `setListAdapter()` — in this case, providing an `ArrayAdapter` wrapping an array of nonsense strings. To find out when the list selection changes, override `onItemClick()` and take appropriate steps based on the supplied child view and position (in this case, updating the label with the text for that position).

The results?



*Figure 97: The ListViewDemo sample application*

The second parameter to our `ArrayAdapter` — `android.R.layout.simple_list_item_1` — controls what the rows look like. The value used in the preceding example provides the standard Android list row: big font, lots of padding, white text.

## Clicks versus Selections

One thing that can confuse some Android developers is the distinction between clicks and selections. One might think that they are the same thing — after all, clicking on something selects it, right?

Well, no. At least, not in Android. At least not all of the time.

Android is designed to be used with touchscreen devices and non-touchscreen devices. Historically, Android has been dominated by devices that only offered touchscreens. However, Google TV devices are not touchscreens at present. And some Android devices offer both touchscreens and some other sort of pointing device — D-pad, trackball, arrow keys, etc.

To accommodate both styles of device, Android sometimes makes a distinction between selection events and click events. Widgets based off of the “spinner” paradigm — including `Spinner` and `Gallery` — treat everything as selection events. Other widgets — like `ListView` and `GridView` — treat selection events and click events differently. For these widgets, selection events are driven by the pointing device, such as using arrow keys to move a highlight bar up and down a list. Click events are when the user either “clicks” the pointing device (e.g., presses the center D-pad button) or taps on something in the widget using the touchscreen.

### Selection Modes

By default, `ListView` is set up simply to collect clicks on list entries. Sometimes, though, you want a list that tracks a user’s selection, or possibly multiple selections. `ListView` can handle that as well, but it requires a few changes.

First, you will need to call `setChoiceMode()` on the `ListView` in Java code to set the choice mode, supplying either `CHOICE_MODE_SINGLE` or `CHOICE_MODE_MULTIPLE` as the value. You can get your `ListView` from a `ListActivity` via `getListView()`. You can also declare this via the `android:choiceMode` attribute in your layout XML.

Then, rather than use `android.R.layout.simple_list_item_1` as the layout for the list rows in your `ArrayAdapter` constructor, you will need to use either `android.R.layout.simple_list_item_single_choice` or `android.R.layout.simple_list_item_multiple_choice` for single-choice or multiple-choice lists, respectively.

For example, here is an activity layout from [the Selection/Checklist sample project](#):

```
<?xml version="1.0" encoding="utf-8"?>
<ListView
xmlns:android="http://schemas.android.com/apk/res/android"
    android:id="@android:id/list"
    android:layout_width="fill_parent"
    android:layout_height="fill_parent"
    android:drawSelectorOnTop="false"
    android:choiceMode="multipleChoice"
/>
```

It is a full-screen `ListView`, with the `android:choiceMode="multipleChoice"` attribute to indicate that we want multiple choice support.

## ADAPTERVIEWS AND ADAPTERS

---

Our activity just uses a standard ArrayAdapter on our list of nonsense words, but uses `android.R.layout.simple_list_item_multiple_choice` as the row layout:

```
package com.commonware.android.checklist;

import android.app.ListActivity;
import android.os.Bundle;
import android.widget.ArrayAdapter;

public class ChecklistDemo extends ListActivity {
    private static final String[] items={"lorem", "ipsum", "dolor",
        "sit", "amet",
        "consectetuer", "adipiscing", "elit", "morbi", "vel",
        "ligula", "vitae", "arcu", "aliquet", "mollis",
        "etiam", "vel", "erat", "placerat", "ante",
        "porttitor", "sodales", "pellentesque", "augue", "purus"};

    @Override
    public void onCreate(Bundle icle) {
        super.onCreate(icle);
        setContentView(R.layout.main);
        setListAdapter(new ArrayAdapter<String>(this,
            android.R.layout.simple_list_item_multiple_choice,
            items));
    }
}
```

What the user sees is the list of words with checkboxes down the right edge:

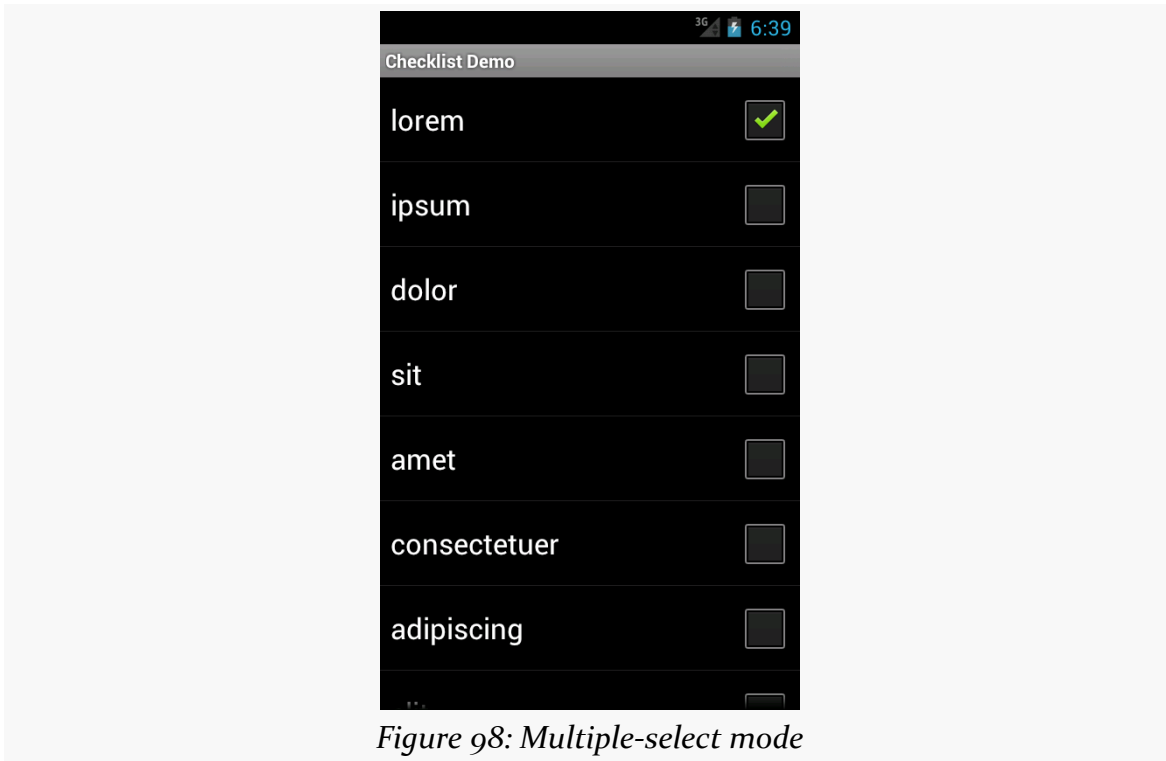


Figure 98: Multiple-select mode

If we wanted, we could call methods like `getCheckedItemPositions()` on our `ListView` to find out which items the user checked, or `setItemChecked()` if we wanted to check (or un-check) a specific entry ourselves.

### Clicks versus Selections, Revisited

If the user clicks a row in a `ListView`, a click event is registered, triggering things like `onListItemClick()` in an `OnItemClickListener`. If the user uses a pointing device to change a selection (e.g., pressing up and down arrows to move a highlight bar in the `ListView`), that triggers `onItemSelected()` in an `OnItemSelectedListener`.

Many times, particularly if the `ListView` is the entire UI at present, you only care about clicks. Sometimes, particularly if the `ListView` is adjacent to something else (e.g., on a TV, where you have more screen space *and* do not have a touchscreen), you will care more about selection events. Either way, you can get the events you need.

## Spin Control

In Android, the Spinner is the equivalent of the drop-down selector you might find in other toolkits (e.g., JComboBox in Java/Swing). Pressing the center button on the D-pad pops up a selection dialog for the user to choose an item from. You basically get the ability to select from a list without taking up all the screen space of a ListView, at the cost of an extra click or screen tap to make a change.

As with ListView, you provide the adapter for data and child views via `setAdapter()` and hook in a listener object for selections via `setOnItemSelectedListener()`.

If you want to tailor the view used when displaying the drop-down perspective, you need to configure the adapter, not the Spinner widget. Use the `setDropDownViewResource()` method to supply the resource ID of the view to use.

For example, culled from [the Selection/Spinner sample project](#), here is an XML layout for a simple view with a Spinner:

```
<?xml version="1.0" encoding="utf-8"?>
<LinearLayout
  xmlns:android="http://schemas.android.com/apk/res/android"
  android:orientation="vertical"
  android:layout_width="fill_parent"
  android:layout_height="fill_parent"
  >
  <TextView
    android:id="@+id/selection"
    android:layout_width="fill_parent"
    android:layout_height="wrap_content"
    />
  <Spinner android:id="@+id/spinner"
    android:layout_width="fill_parent"
    android:layout_height="wrap_content"
    />
</LinearLayout>
```

This is the same view as shown in [a previous section](#), just with a Spinner instead of a ListView.

To populate and use the Spinner, we need some Java code:

```
public class SpinnerDemo extends Activity
  implements AdapterView.OnItemSelectedListener {
  private TextView selection;
  private static final String[] items={"lorem", "ipsum", "dolor",
```



```
        "sit", "amet",
        "consectetuer", "adipiscing", "elit", "morbi", "vel",
        "ligula", "vitae", "arcu", "aliquet", "mollis",
        "etiam", "vel", "erat", "placerat", "ante",
        "porttitor", "sodales", "pellentesque", "augue", "purus"};

@Override
public void onCreate(Bundle savedInstanceState) {
    super.onCreate(savedInstanceState);
    setContentView(R.layout.main);
    selection=(TextView)findViewById(R.id.selection);

    Spinner spin=(Spinner)findViewById(R.id.spinner);
    spin.setOnItemSelectedListener(this);

    ArrayAdapter<String> aa=new ArrayAdapter<String>(this,
        android.R.layout.simple_spinner_item,
        items);

    aa.setDropDownViewResource(
        android.R.layout.simple_spinner_dropdown_item);
    spin.setAdapter(aa);
}

@Override
public void onItemSelected(AdapterView<?> parent,
    View v, int position, long id) {
    selection.setText(items[position]);
}

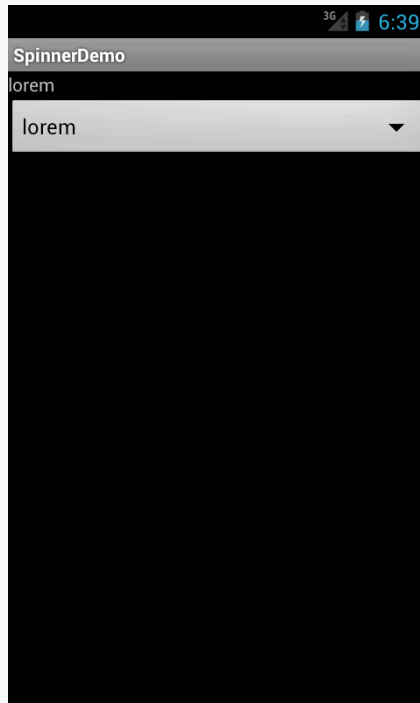
@Override
public void onNothingSelected(AdapterView<?> parent) {
    selection.setText("");
}
}
```

Here, we attach the activity itself as the selection listener (`spin.setOnItemSelectedListener(this)`), as Spinner widgets only support selection events, not click events. This works because the activity implements the `OnItemSelectedListener` interface. We configure the adapter not only with the list of fake words, but also with a specific resource to use for the drop-down view (via `aa.setDropDownViewResource()`). Also note the use of `android.R.layout.simple_spinner_item` as the built-in View for showing items in the spinner itself. Finally, we implement the callbacks required by `OnItemSelectedListener` to adjust the selection label based on user input.

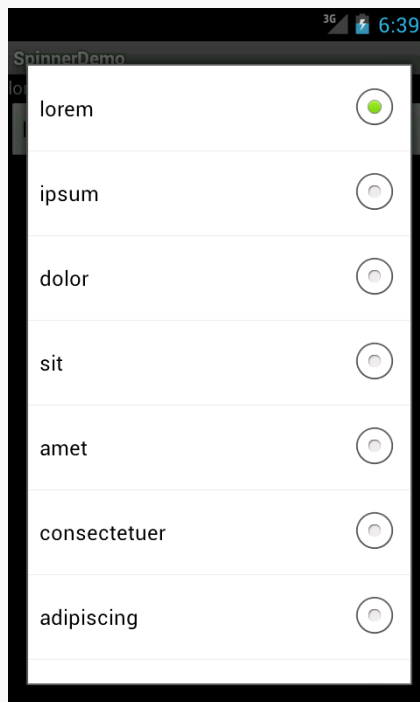
What we get is:

## ADAPTERVIEWS AND ADAPTERS

---



*Figure 99: The SpinnerDemo sample application, as initially launched*



*Figure 100: The same application, with the spinner drop-down list displayed*

## Grid Your Lions (Or Something Like That...)

As the name suggests, `GridView` gives you a two-dimensional grid of items to choose from. You have moderate control over the number and size of the columns; the number of rows is dynamically determined based on the number of items the supplied adapter says are available for viewing.

There are a few properties which, when combined, determine the number of columns and their sizes:

1. `android:numColumns` spells out how many columns there are, or, if you supply a value of `auto_fit`, Android will compute the number of columns based on available space and the properties listed below.
2. `android:verticalSpacing` and `android:horizontalSpacing` indicate how much whitespace there should be between items in the grid.
3. `android:columnWidth` indicates how wide each column should be, in terms of some dimension value (e.g., `40dp` or `@dimen/grid_column_width`).
4. `android:stretchMode` indicates, for grids with `auto_fit` for `android:numColumns`, what should happen for any available space not taken up by columns or spacing — this should be `columnWidth` to have the columns take up available space or `spacingWidth` to have the whitespace between columns absorb extra space.

Otherwise, the `GridView` works much like any other selection widget — use `setAdapter()` to provide the data and child views, invoke `setOnItemSelectedListener()` to register a selection listener, etc.

For example, here is an XML layout from [the Selection/Grid sample project](#), showing a `GridView` configuration:

```
<?xml version="1.0" encoding="utf-8"?>
<LinearLayout
  xmlns:android="http://schemas.android.com/apk/res/android"
  android:orientation="vertical"
  android:layout_width="fill_parent"
  android:layout_height="fill_parent"
  >
  <TextView
    android:id="@+id/selection"
    android:layout_width="fill_parent"
    android:layout_height="wrap_content"
    />
  <GridView
    android:id="@+id/grid"
```

## ADAPTERVIEWS AND ADAPTERS

---

```
    android:layout_width="fill_parent"
    android:layout_height="fill_parent"
    android:verticalSpacing="40dip"
    android:horizontalSpacing="5dip"
    android:numColumns="auto_fit"
    android:columnWidth="100dip"
    android:stretchMode="columnWidth"
    android:gravity="center"
  />
```

```
</LinearLayout>
```

For this grid, we take up the entire screen except for what our selection label requires. The number of columns is computed by Android (`android:numColumns = "auto_fit"`) based on our horizontal spacing (`android:horizontalSpacing = "5dip"`) and columns width (`android:columnWidth = "100dip"`), with the columns absorbing any “slop” width left over (`android:stretchMode = "columnWidth"`).

The Java code to configure the GridView is:

```
package com.commonware.android.grid;

import android.app.Activity;
import android.os.Bundle;
import android.view.View;
import android.widget.AdapterView;
import android.widget.AdapterView.OnItemClickListener;
import android.widget.ArrayAdapter;
import android.widget.GridView;
import android.widget.TextView;

public class GridDemo extends Activity
    implements AdapterView.OnItemClickListener {
    private TextView selection;
    private static final String[] items={"lorem", "ipsum", "dolor",
        "sit", "amet",
        "consectetuer", "adipiscing", "elit", "morbi", "vel",
        "ligula", "vitae", "arcu", "aliquet", "mollis",
        "etiam", "vel", "erat", "placerat", "ante",
        "porttitor", "sodales", "pellentesque", "augue", "purus"};

    @Override
    public void onCreate(Bundle icle) {
        super.onCreate(icle);
        setContentView(R.layout.main);
        selection=(TextView)findViewById(R.id.selection);

        GridView g=(GridView) findViewById(R.id.grid);
        g.setAdapter(new ArrayAdapter<String>(this,
            R.layout.cell,
            items));
        g.setOnItemClickListener(this);
    }
}
```

## ADAPTERVIEWS AND ADAPTERS

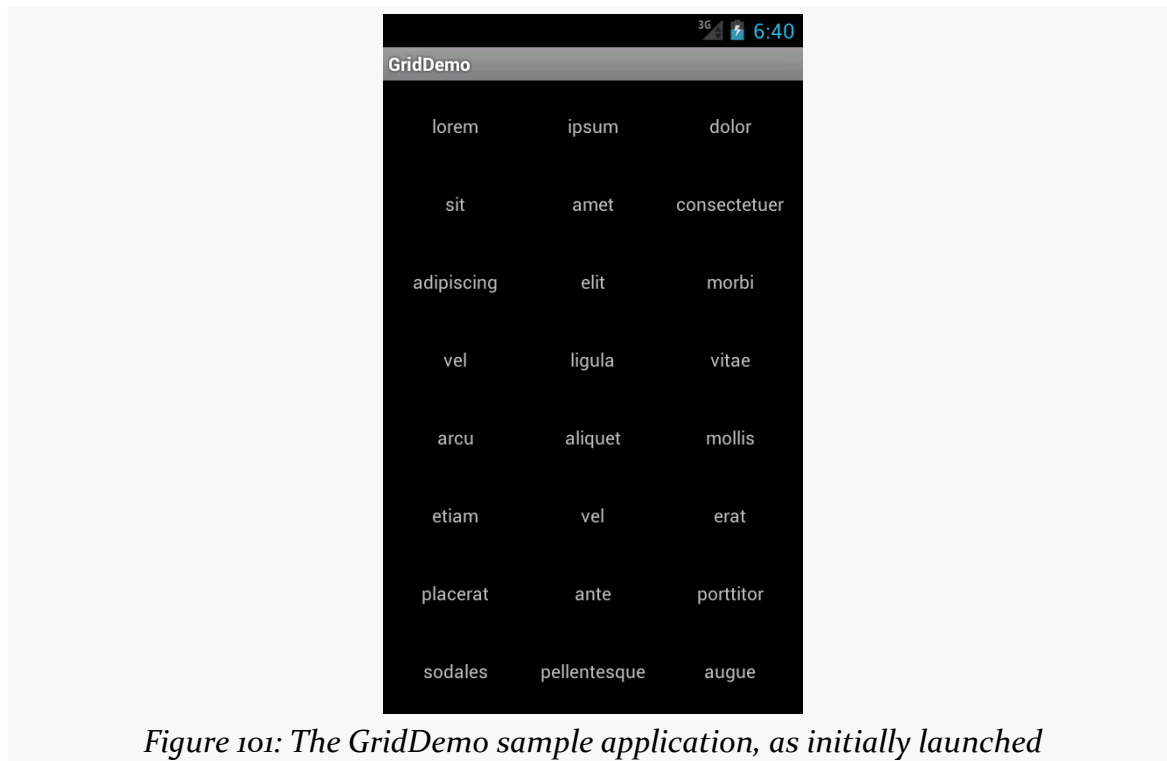
---

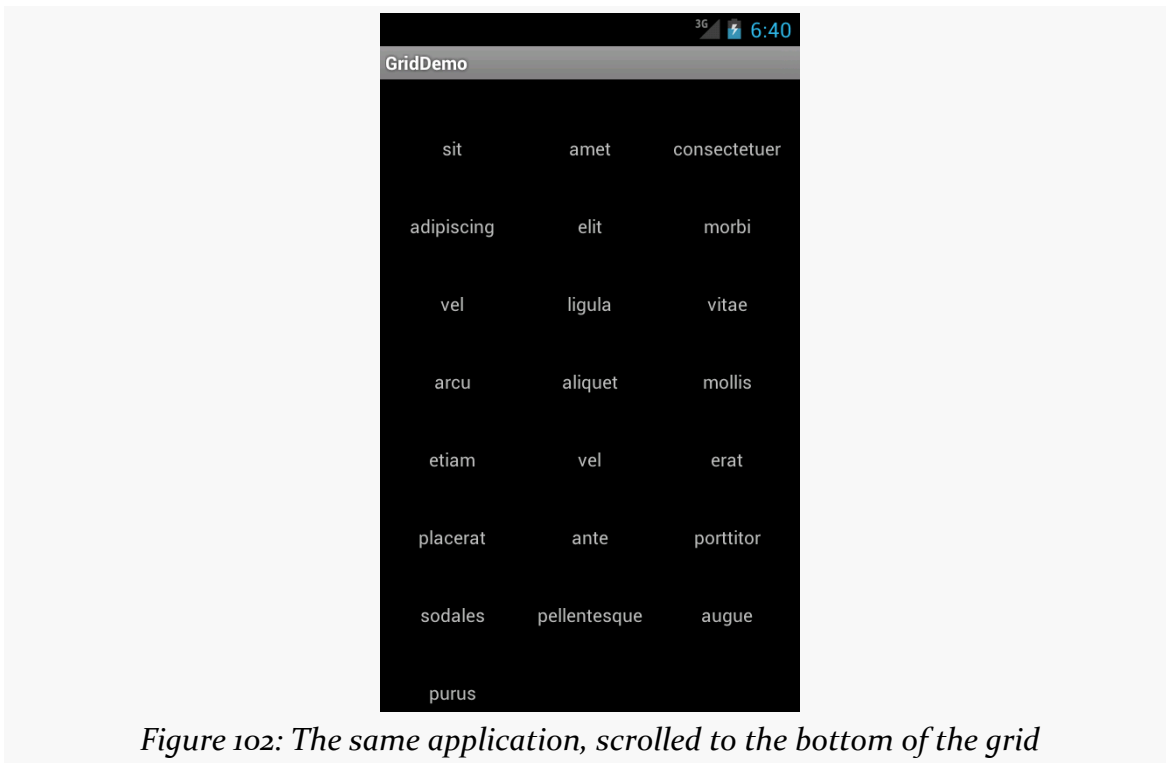
```
@Override
public void onItemClick(AdapterView<?> parent, View v,
                        int position, long id) {
    selection.setText(items[position]);
}
}
```

The grid cells are defined by a separate `res/layout/cell.xml` file, referenced in our `ArrayAdapter` as `R.layout.cell`:

```
<?xml version="1.0" encoding="utf-8"?>
<TextView
    xmlns:android="http://schemas.android.com/apk/res/android"
    android:layout_width="wrap_content"
    android:layout_height="wrap_content"
    android:textSize="14dip"
/>
```

With the vertical spacing from the XML layout (`android:verticalSpacing = "40dip"`), the grid overflows the boundaries of the emulator's screen:





*Figure 102: The same application, scrolled to the bottom of the grid*

GridView, like ListView, supports both click events and selection events. In this sample, we register an `OnItemClickListener` to listen for click events.

## Fields: Now With 35% Less Typing!

The `AutoCompleteTextView` is sort of a hybrid between the `EditText` (field) and the `Spinner`. With auto-completion, as the user types, the text is treated as a prefix filter, comparing the entered text as a prefix against a list of candidates. Matches are shown in a selection list that folds down from the field. The user can either type out an entry (e.g., something not in the list) or choose an entry from the list to be the value of the field.

`AutoCompleteTextView` subclasses `EditText`, so you can configure all the standard look-and-feel aspects, such as font face and color.

In addition, `AutoCompleteTextView` has an `android:completionThreshold` property, to indicate the minimum number of characters a user must enter before the list filtering begins.

## ADAPTERVIEWS AND ADAPTERS

---

You can give `AutoCompleteTextView` an adapter containing the list of candidate values via `setAdapter()`. However, since the user could type something not in the list, `AutoCompleteTextView` does not support selection listeners. Instead, you can register a `TextWatcher`, like you can with any `EditText`, to be notified when the text changes. These events will occur either because of manual typing or from a selection from the drop-down list.

Below we have a familiar-looking XML layout, this time containing an `AutoCompleteTextView` (pulled from [the Selection/AutoComplete sample application](#)):

```
<?xml version="1.0" encoding="utf-8"?>
<LinearLayout
  xmlns:android="http://schemas.android.com/apk/res/android"
  android:orientation="vertical"
  android:layout_width="fill_parent"
  android:layout_height="fill_parent"
  >
  <TextView
    android:id="@+id/selection"
    android:layout_width="fill_parent"
    android:layout_height="wrap_content"
    />
  <AutoCompleteTextView android:id="@+id/edit"
    android:layout_width="fill_parent"
    android:layout_height="wrap_content"
    android:completionThreshold="3"/>
</LinearLayout>
```

The corresponding Java code is:

```
package com.commonsware.android.auto;

import android.app.Activity;
import android.os.Bundle;
import android.text.Editable;
import android.text.TextWatcher;
import android.widget.AdapterView;
import android.widget.AutoCompleteTextView;
import android.widget.TextView;

public class AutoCompleteDemo extends Activity
  implements TextWatcher {
  private TextView selection;
  private AutoCompleteTextView edit;
  private static final String[] items={"lorem", "ipsum", "dolor",
    "sit", "amet",
    "consectetuer", "adipiscing", "elit", "morbi", "vel",
    "ligula", "vitae", "arcu", "aliquet", "mollis",
    "etiam", "vel", "erat", "placerat", "ante",
```

## ADAPTERVIEWS AND ADAPTERS

---

```
        "porttitor", "sodales", "pellentesque", "augue", "purus"};

@Override
public void onCreate(Bundle savedInstanceState) {
    super.onCreate(savedInstanceState);
    setContentView(R.layout.main);
    selection=(TextView)findViewById(R.id.selection);
    edit=(AutoCompleteTextView)findViewById(R.id.edit);
    edit.addTextChangedListener(this);

    edit.setAdapter(new ArrayAdapter<String>(this,
        android.R.layout.simple_dropdown_item_1line,
        items));
}

@Override
public void onTextChanged(CharSequence s, int start, int before,
    int count) {
    selection.setText(edit.getText());
}

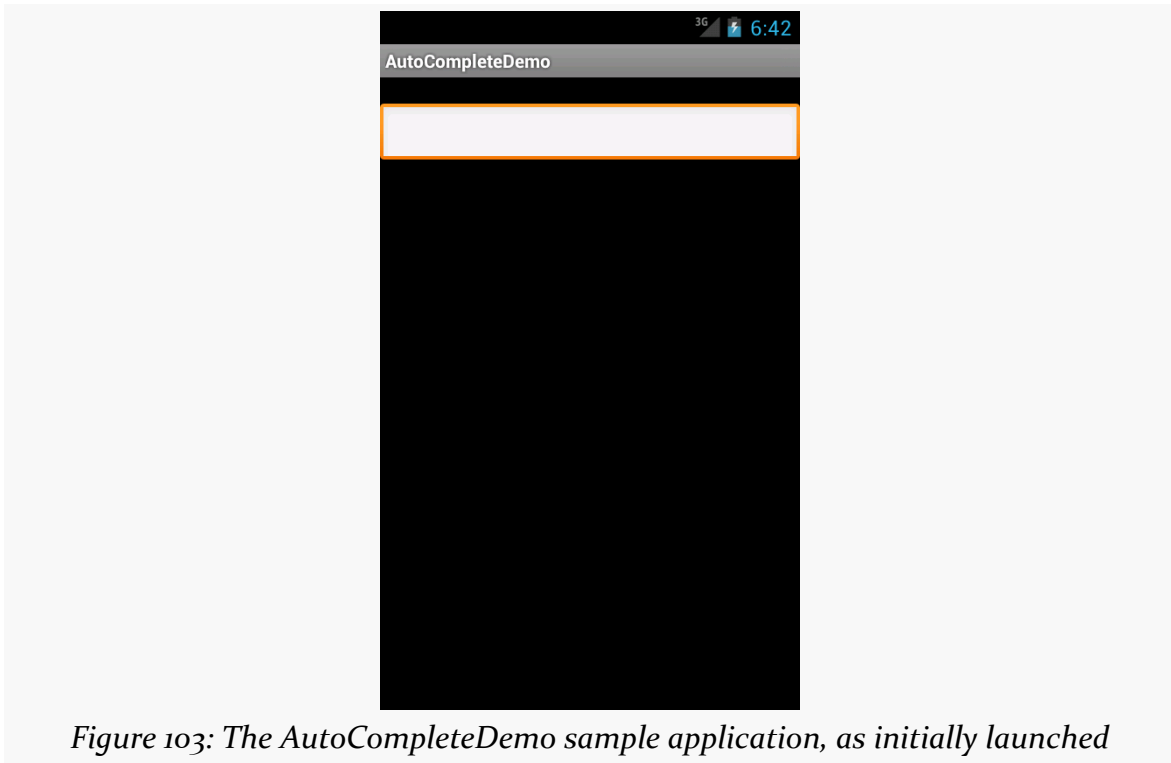
@Override
public void beforeTextChanged(CharSequence s, int start,
    int count, int after) {
    // needed for interface, but not used
}

@Override
public void afterTextChanged(Editable s) {
    // needed for interface, but not used
}
}
```

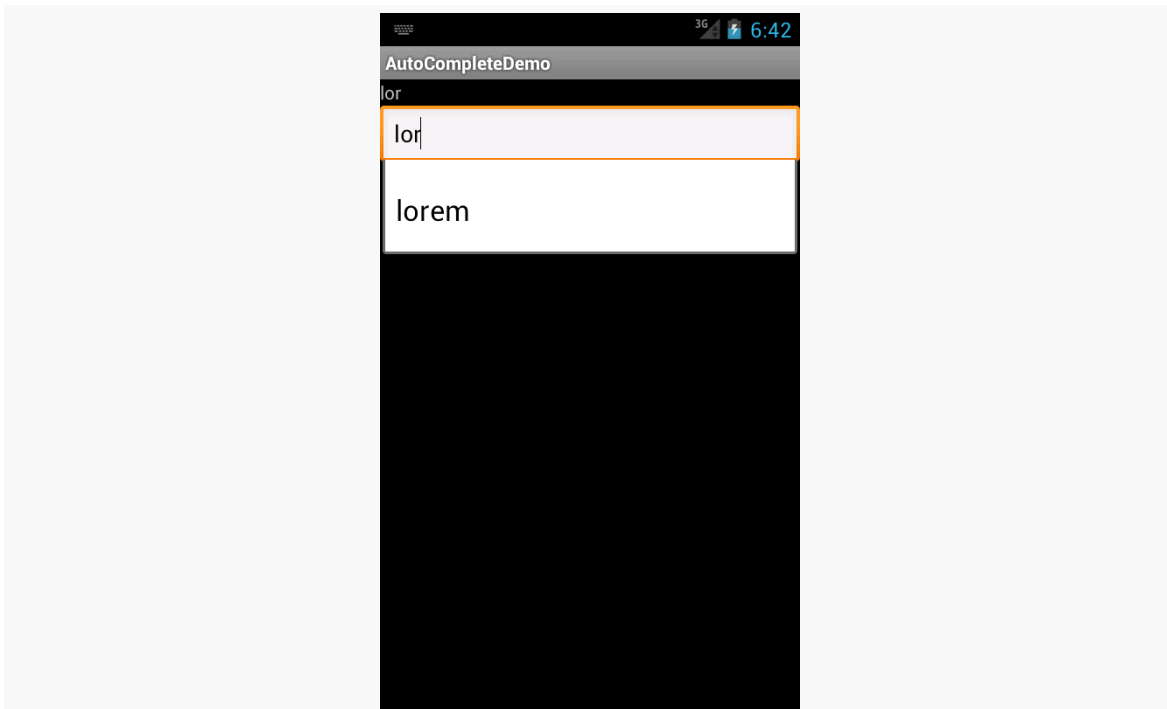
This time, our activity implements `TextWatcher`, which means our callbacks are `onTextChanged()`, `beforeTextChanged()`, and `afterTextChanged()`. In this case, we are only interested in the former, and we update the selection label to match the `AutoCompleteTextView`'s current contents.

Here we have the results:

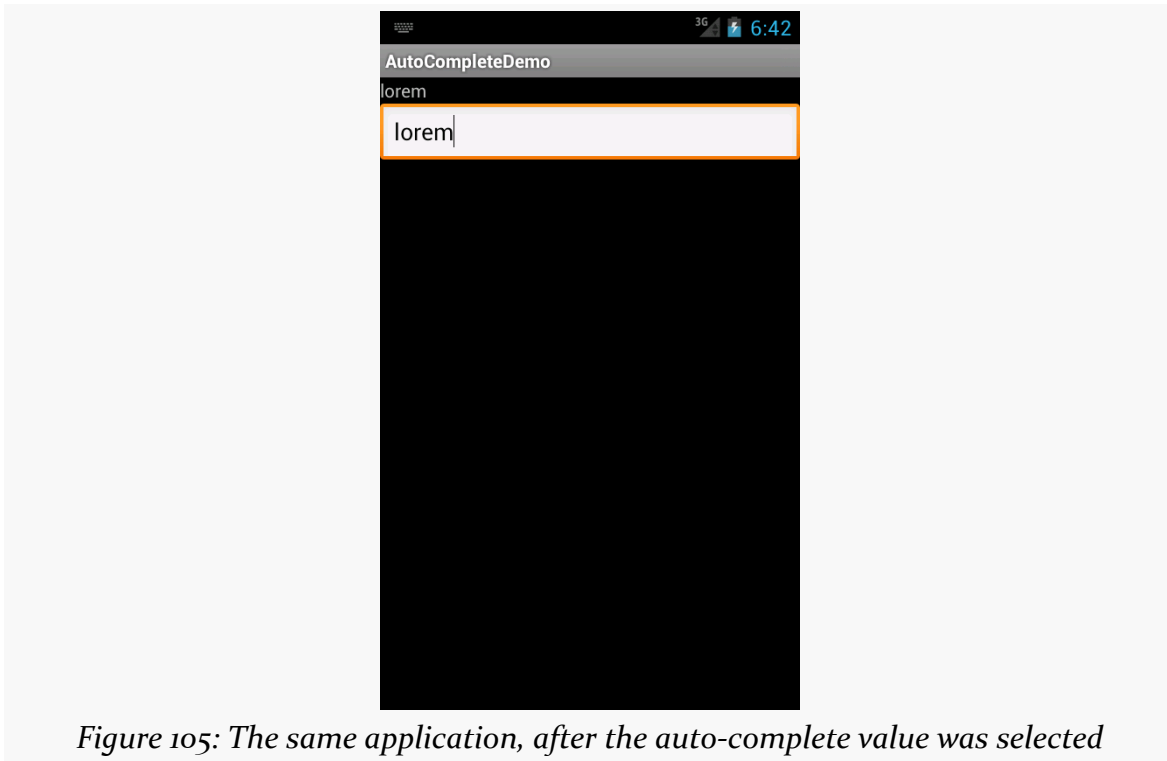




*Figure 103: The AutoCompleteDemo sample application, as initially launched*



*Figure 104: The same application, after a few matching letters were entered, showing the auto-complete drop-down*



*Figure 105: The same application, after the auto-complete value was selected*

## Galleries, Give Or Take The Art

The Gallery widget is not one ordinarily found in GUI toolkits. It is, in effect, a horizontally-laid-out listbox. One choice follows the next across the horizontal plane, with the currently-selected item highlighted. On an Android device, one rotates through the options through the left and right D-pad buttons.

Compared to the `ListView`, the Gallery takes up less screen space while still showing multiple choices at one time (assuming they are short enough). Compared to the `Spinner`, the Gallery always shows more than one choice at a time.

The quintessential example use for the Gallery is image preview — given a collection of photos or icons, the Gallery lets people preview the pictures in the process of choosing one.

Code-wise, the Gallery works much like a `Spinner` or `GridView`. In your XML layout, you have a few properties at your disposal:

1. `android:spacing` controls the number of pixels between entries in the list

2. `android:spinnerSelector` controls what is used to indicate a selection – this can either be a reference to a Drawable (see the [resources chapter](#)) or an RGB value in `#AARRGGBB` or similar notation
3. `android:drawSelectorOnTop` indicates if the selection bar (or Drawable) should be drawn before (`false`) or after (`true`) drawing the selected child – if you choose `true`, be sure that your selector has sufficient transparency to show the child through the selector, otherwise users will not be able to read the selection

Note that the `Gallery` widget is now marked as deprecated, meaning that ideally you use something else. One likely candidate — `ViewPager` — will be covered [in an upcoming chapter](#).

## Customizing the Adapter

The humble `ListView` is one of the most important widgets in all of Android, simply because it is used so frequently. Whether choosing a contact to call or an email message to forward or an ebook to read, `ListView` widgets are employed in a wide range of activities.

Of course, it would be nice if they were more than just plain text.

The good news is that they can be as fancy as you want, within the limitations of a mobile device's screen, of course. However, making them more elaborate takes some work.

Note that while this section will be using `ListView` as the `AdapterView`, the same techniques hold for *any* `AdapterView`.

## The Single Layout Pattern

The simplest way of creating custom `ListView` rows (or `GridView` cells or whatever) is when they all have the same basic structure and can be created from the same layout XML resource. This does not mean they have to be strictly identical, but that you can make whatever changes you need just by configuring the widgets (e.g., make some things `VISIBLE` or `GONE`).

This is not especially difficult, though it does take a few more steps than what we have seen previously.

### Step #0: Get Things Set Up Simply

First, create your activity (e.g., `ListActivity`), get your data (e.g., array of Java strings), and set up your `AdapterView` with a simple adapter following the steps outlined in the preceding sections.

Here, we will examine [the Selection/Dynamic sample project](#). We will use a simple `ListActivity` (taking the default layout of a full-screen `ListView`) and use the same list of 25 nonsense words used in earlier samples. However, this time, we want to have a more elaborate row, taking into account the length of the nonsense word.

### Step #1: Design Your Row

Next, create a layout XML resource that will represent one row in your `ListView` (or cell in your `GridView` or whatever).

For example, our `res/layout/row.xml` resource will use a pair of nested `LinearLayout` containers to organize two `TextView` widgets and an `ImageView`:

```
<?xml version="1.0" encoding="utf-8"?>
<LinearLayout xmlns:android="http://schemas.android.com/apk/res/android"
    android:layout_width="fill_parent"
    android:layout_height="wrap_content"
    android:orientation="horizontal">

    <ImageView
        android:id="@+id/icon"
        android:layout_width="wrap_content"
        android:layout_height="wrap_content"
        android:layout_gravity="center_vertical"
        android:padding="2dip"
        android:src="@drawable/ok"
        android:contentDescription="@string/icon"/>

    <LinearLayout
        android:layout_width="fill_parent"
        android:layout_height="wrap_content"
        android:orientation="vertical">

        <TextView
            android:id="@+id/label"
            android:layout_width="wrap_content"
            android:layout_height="wrap_content"
            android:textSize="25sp"
            android:textStyle="bold"/>

        <TextView
            android:id="@+id/size"
```

```
        android:layout_width="wrap_content"
        android:layout_height="wrap_content"
        android:textSize="15sp"/>
    </LinearLayout>
</LinearLayout>
```

The `ImageView` will use one of two drawable resources, one for short words, and another for long words.

### Step #2: Extend `ArrayAdapter`

If you just used `R.layout.row` with a regular `ArrayAdapter`, it would work, insofar as it would not crash. However, `ArrayAdapter` only knows how to update a single `TextView` in a row, so it would ignore our other `TextView`, let alone the `ImageView`.

So, we need to create our own `ListAdapter`, by creating our own subclass of `ArrayAdapter`.

Since an `Adapter` is tightly coupled to the `AdapterView` that uses it, it is typically simplest to make the custom `ArrayAdapter` subclass be an inner class of whoever manages the `AdapterView`. Hence, in our sample, we will create an `IconicAdapter` inner class of our `ListActivity`.

### Step #3: Override the Constructor and `getView()`

The `IconicAdapter` constructor can chain to the superclass and supply the necessary data, such as our Java array of nonsense words. The real fun comes when we override `getView()`:

```
package com.commonware.android.fancylists.three;

import android.app.ListActivity;
import android.os.Bundle;
import android.view.View;
import android.view.ViewGroup;
import android.widget.ArrayAdapter;
import android.widget.ImageView;
import android.widget.TextView;

public class DynamicDemo extends ListActivity {
    private static final String[] items={"lorem", "ipsum", "dolor",
        "sit", "amet",
        "consectetuer", "adipiscing", "elit", "morbi", "vel",
        "ligula", "vitae", "arcu", "aliquet", "mollis",
        "etiam", "vel", "erat", "placerat", "ante",
```

## ADAPTERVIEWS AND ADAPTERS

---

```
        "porttitor", "sodales", "pellentesque", "augue", "purus"};

@Override
public void onCreate(Bundle icle) {
    super.onCreate(icle);
    setListAdapter(new IconicAdapter());
}

class IconicAdapter extends ArrayAdapter<String> {
    IconicAdapter() {
        super(DynamicDemo.this, R.layout.row, R.id.label, items);
    }

    @Override
    public View getView(int position, View convertView,
        ViewGroup parent) {
        View row=super.getView(position, convertView, parent);
        ImageView icon=(ImageView)row.findViewById(R.id.icon);

        if (items[position].length()>4) {
            icon.setImageResource(R.drawable.delete);
        }
        else {
            icon.setImageResource(R.drawable.ok);
        }

        TextView size=(TextView)row.findViewById(R.id.size);

        size.setText(String.format(getString(R.string.size_template),
items[position].length()));

        return(row);
    }
}
```

Our `getView()` implementation does three things:

- It chains to the superclass' implementation of `getView()`, which returns to us an instance of our row View, as prepared by `ArrayAdapter`. In particular, our word has already been put into one `TextView`, since `ArrayAdapter` does that normally.
- It finds our `ImageView` and applies a business rule to set which icon should be used, referencing one of two drawable resources (`R.drawable.ok` and `R.drawable.delete`).
- It finds our other `TextView` and populates it as well, by pulling in the value of a string resource and using `String.format()` to pour in our word length.

## ADAPTERVIEWS AND ADAPTERS

---

Note that we call `findViewById()` not on the activity, but rather on the row returned by the superclass' implementation of `getView()`. **Always call `findViewById()` on something that is guaranteed to give you a unique result.** In the case of an `AdapterView`, there will be many rows, cells, etc. — calling `findViewById()` on the activity might return widgets with the right name but from other rows or cells.

This gives us:

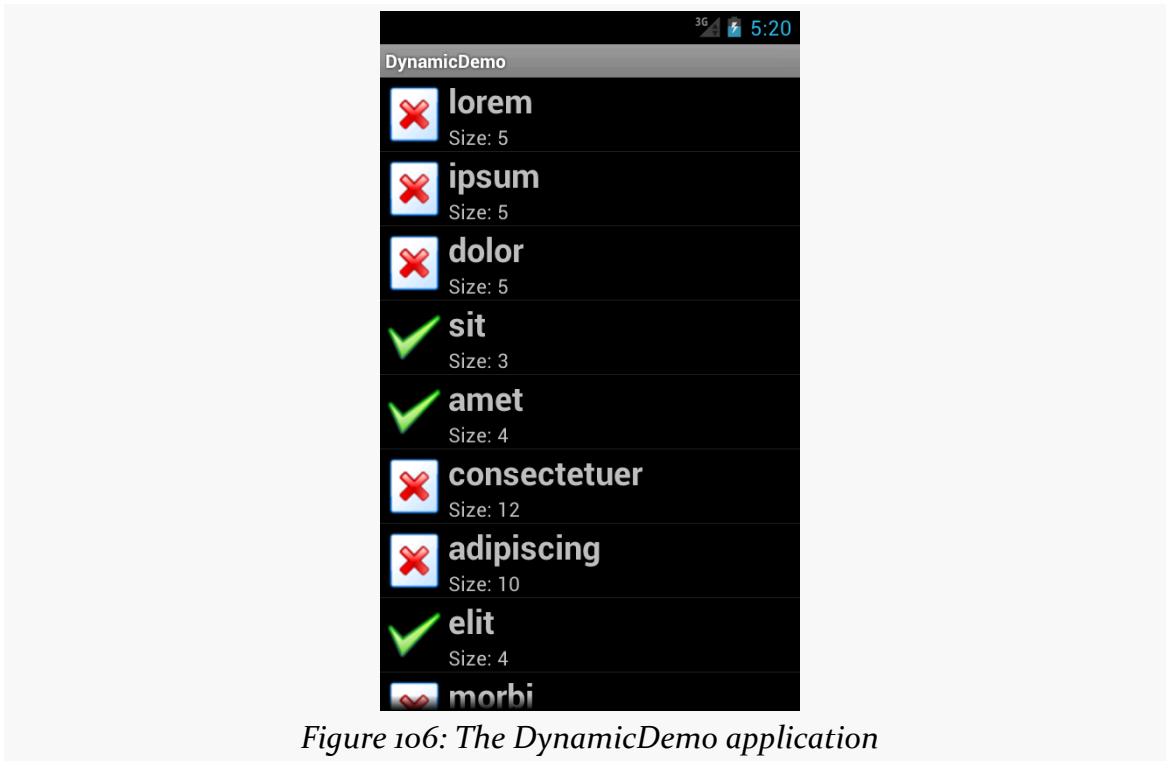


Figure 106: The *DynamicDemo* application

The approach of overriding `getView()` works for `ArrayAdapter`, but some other types of adapters would have alternatives. We will see that mostly with `CursorAdapter`, profiled in upcoming chapters.

### Optimizing with the ViewHolder Pattern

A somewhat expensive operation we do a lot with more elaborate list rows is call `findViewById()`. This dives into our row and pulls out widgets by their assigned identifiers, so we can customize the widget contents (e.g., change the text of a `TextView`, change the icon in an `ImageView`). Since `findViewById()` can find widgets anywhere in the tree of children of the row's root `View`, this could take a fair number



of instructions to execute, particularly if we keep having to re-find widgets we had found once before.

In some GUI toolkits, this problem is avoided by having the composite View objects, like our rows, be declared totally in program code (in this case, Java). Then, accessing individual widgets is merely the matter of calling a getter or accessing a field. And you can certainly do that with Android, but the code gets rather verbose. What would be nice is a way where we can still use the layout XML yet cache our row's key child widgets so we only have to find them once.

That's where the holder pattern comes into play, in a class we will call ViewHolder.

All View objects have `getTag()` and `setTag()` methods. These allow you to associate an arbitrary object with the widget. What the holder pattern does is use that "tag" to hold an object that, in turn, holds each of the child widgets of interest. By attaching that holder to the row View, every time we use the row, we already have access to the child widgets we care about, without having to call `findViewById()` again.

So, let's take a look at one of these holder classes (taken from [the Selection/ViewHolder sample project](#), a revised version of the Selection/Dynamic sample from before):

```
package com.commonware.android.fancylists.five;

import android.view.View;
import android.widget.ImageView;
import android.widget.TextView;

class ViewHolder {
    ImageView icon=null;
    TextView size=null;

    ViewHolder(View row) {
        this.icon=(ImageView)row.findViewById(R.id.icon);
        this.size=(TextView)row.findViewById(R.id.size);
    }
}
```

ViewHolder holds onto the child widgets, initialized via `findViewById()` in its constructor. The widgets are simply package-protected data members, accessible from other classes in this project... such as a ViewHolderDemo activity. In this case, we are only holding onto two widgets — the icon and the second label — since we will let ArrayAdapter handle our first label for us. In our case, we are holding onto the TextView and ImageView widgets that we want to populate in `getView()`.

## ADAPTERVIEWS AND ADAPTERS

---

Using ViewHolder is a matter of creating an instance whenever we inflate a row and attaching said instance to the row View via `setTag()`, as shown in this rewrite of `getView()`, found in `ViewHolderDemo`:

```
@Override
public View getView(int position, View convertView,
                    ViewGroup parent) {
    View row=super.getView(position, convertView, parent);
    ViewHolder holder=(ViewHolder)row.getTag();

    if (holder==null) {
        holder=new ViewHolder(row);
        row.setTag(holder);
    }

    if (getModel(position).length()>4) {
        holder.icon.setImageResource(R.drawable.delete);
    }
    else {
        holder.icon.setImageResource(R.drawable.ok);
    }

    holder.size.setText(String.format(getString(R.string.size_template),
items[position].length()));

    return(row);
}
```

If the call to `getTag()` on the row returns `null`, we know we need to create a new `ViewHolder`, which we then attach to the row via `setTag()` for later reuse. Then, accessing the child widgets is merely a matter of accessing the data members on the holder.

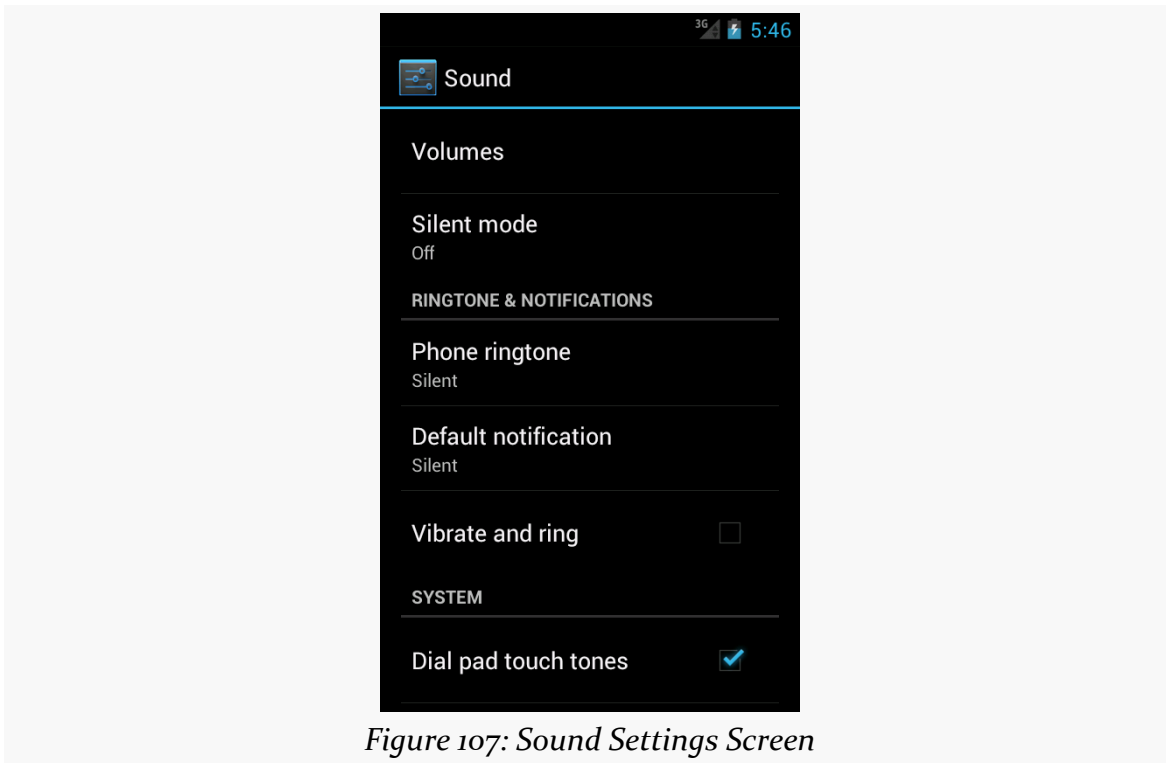
This takes advantage of the fact that rows in a `ListView` get *recycled* – a 25,000-row list does not create 25,000 rows. The recycling itself is handled for us by `ArrayAdapter`, so we simply have to create our `ViewHolder` when needed and reuse the existing `ViewHolder` when a row gets recycled. The first time the `ListView` is displayed, all new rows need to be created, and we wind up creating a `ViewHolder` for each. As the user scrolls, rows get recycled, and we can reuse their corresponding `ViewHolder` widget caches. We will cover this recycling process in greater detail [in a later chapter](#).

Note that the `getModel()` method shown here retrieves our model `String` for a given position, by using `getListAdapter()` (to retrieve our `IconicAdapter` from the activity's `ListView`) and `getItem()` (to retrieve the data, held by the adapter, represented by the position):

```
private String getModel(int position) {  
    return(((IconicAdapter)getListAdapter()).getItem(position));  
}
```

### Dealing with Multiple Row Layouts

The story gets significantly more complicated if our mix of rows is more complicated. For example, here is the Sound screen in the Settings application:



*Figure 107: Sound Settings Screen*

It may not look like it, but that is a `ListView`. However, not all the rows look the same:

- Some have one line of text (e.g., “Volumes”)
- Some have two lines of text (e.g., “Silent mode” plus “Off”)
- Some have one line of text and a `CheckBox` (e.g., “Vibrate and ring”)
- Some are headings with totally different text formatting (e.g., “RINGTONE & NOTIFICATIONS”)

This is handled by having more than one row layout XML resource used by the adapter. The complexity comes not only in managing those different resources and determining which to use when, but in just having more than one resource – after

all, we only teach ArrayAdapter how to use one. We will examine how to handle this scenario [in a later chapter](#).

### Visit the Trails!

To learn more about ListView, you can turn to [Advanced ListViews](#), which covers other tricks you can do with a ListView.



# The WebView Widget

---

HTML has come a *long* way from Sir Tim Berners-Lee's original vision of using it to publish physics papers.

Not surprisingly, displaying HTML, CSS, and JavaScript in mobile applications is fairly popular, not only for creating full-fledged Web browsers, but for rendering HTML content from RSS/Atom feeds, from HTML-formatted email messages, ebooks (like the one you are reading), and so forth.

There are a couple of ways to display HTML in Android, with the most powerful being the `WebView` widget, the focus of this chapter.

## Role of WebView

If your HTML is fairly limited in scope, such as what you might find in the body of a status update on Twitter, you can use the static `fromHtml()` method on the `Html` utility class to parse an HTML-formatted string into something that you can put into a `TextView`. `TextView` can render simple formatting like styles (bold, italic, etc.), font faces (serif, sans serif, etc.), colors, links, and so forth.

However, sometimes your needs for HTML transcend what `TextView` can handle. You will not be browsing Facebook using `TextView`, for example.

In those cases, `WebView` will be the more appropriate widget, as it can handle a *much* wider range of HTML tags. `WebView` can also handle CSS and JavaScript, which `Html.fromHtml()` would simply ignore. `WebView` can also assist you with common “browsing” metaphors, such as history list of visited URLs to support backwards and forwards navigation.

On the other hand, `WebView` is a much more expensive widget to use, in terms of memory consumption, than is `TextView`.

## WebView and WebKit

The reason for the memory cost of `WebView` is the fact that `WebView` is powered by a fairly complete copy of [WebKit](#). `WebKit` is an open source Web rendering engine that forms the heart of major Web browsers, such as Chrome and Safari. While the version of `WebKit` that lives in Android is one optimized for mobile use, it still represents a fairly substantial code base, and rendering complex Web pages takes up a fair amount of RAM (as anyone with lots of browser tabs on their desktop knows all too well).

Because `WebView` is powered by `WebKit`, content that renders in Chrome and Safari *probably* renders the same in `WebView`. The emphasis on the word “probably” is for a few reasons:

- As mentioned, `WebKit` in Android is a mobile-optimized version, which introduces some differences compared to its desktop brethren
- `WebKit`, like any software project, has its own upgrade cycles and versioning, so different browsers (Chrome vs. Safari vs. `WebView`) will use different versions of the `WebKit` engine, introducing some differences
- Android has tweaked `WebKit` for its own purposes, introducing yet other potential differences

## Adding the Widget

For simple stuff, `WebView` is not significantly different than any other widget in Android — pop it into a layout, tell it what URL to navigate to via Java code, and you are done.

As you can see in [the WebKit/Browser1 sample application](#), here is a simple layout with a `WebView`:

```
<?xml version="1.0" encoding="utf-8"?>
<WebView xmlns:android="http://schemas.android.com/apk/res/android"
    android:id="@+id/webkit"
    android:layout_width="fill_parent"
    android:layout_height="fill_parent"
/>
```

## THE WEBVIEW WIDGET

---

As with any other widget, you need to tell it how it should fill up the space in the layout (in this case, it fills all remaining space).

And, just as with other widgets, you can drag a `WebView` out of the “Composite” section of the Eclipse tool palette and into a layout XML resource in the Graphical Layout editor:



Figure 108: `WebView` in Eclipse Tool Palette

Note that `WebView` knows how to scroll its own contents, so you do not need to put it in a `ScrollView` or `HorizontalScrollView`.

## Loading Content Via a URL

There are a number of ways to load HTML content into a `WebView` widget.

The simplest is to use the `loadUrl()` method, which takes a URL and retrieves its contents over the Internet. For example, here is the activity source code for the `WebKit/Browser1` sample application:

```
package com.commonware.android.browser1;
```



## THE WEBVIEW WIDGET

---

```
import android.app.Activity;
import android.os.Bundle;
import android.webkit.WebView;

public class BrowserDemo1 extends Activity {
    WebView browser;

    @Override
    public void onCreate(Bundle savedInstanceState) {
        super.onCreate(savedInstanceState);
        setContentView(R.layout.main);
        browser=(WebView)findViewById(R.id.webkit);

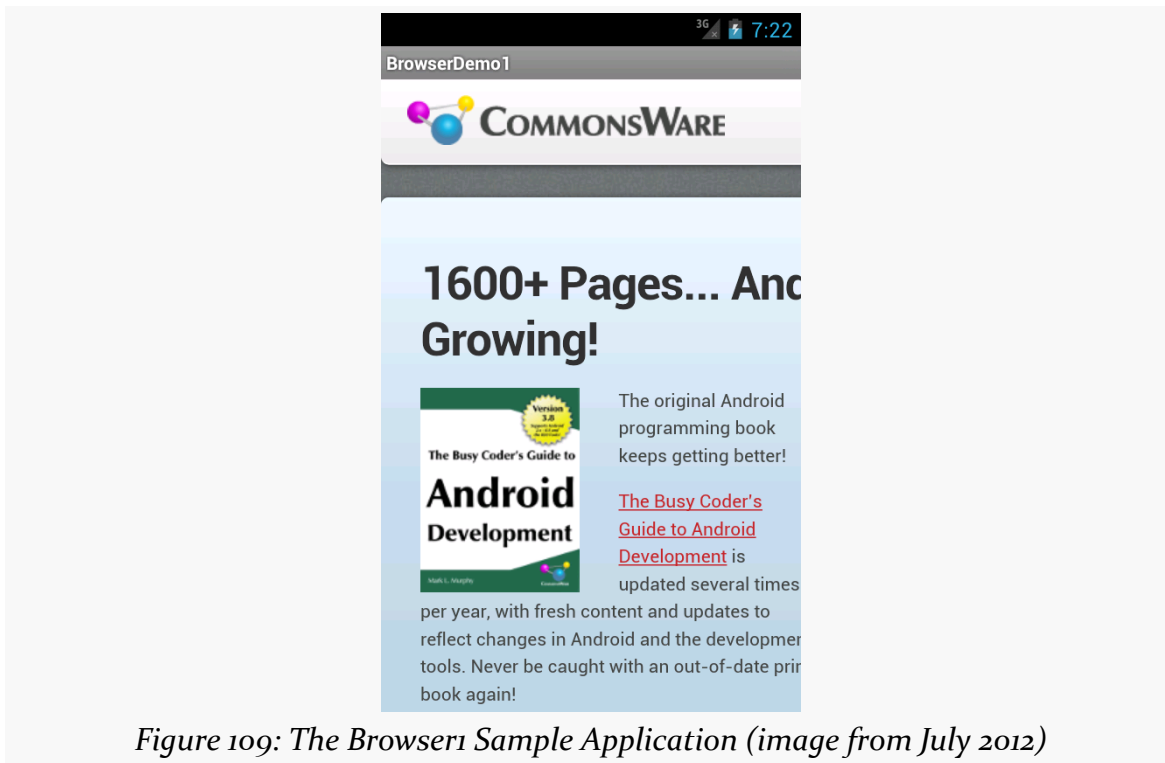
        browser.loadUrl("http://commonsware.com");
    }
}
```

However, we also have to make one change to `AndroidManifest.xml`, adding a line where we request permission to access the Internet:

```
<uses-permission android:name="android.permission.INTERNET"/>
```

If we fail to add this permission, the browser will refuse to load pages. We will discuss more about this “permission” concept [in a later chapter](#).

The resulting activity looks like a Web browser, just with hidden scrollbars:



*Figure 109: The Browser1 Sample Application (image from July 2012)*

As with a regular Android Web browser, you can pan around the page by dragging it, while the directional pad moves you around all the focusable elements on the page.

What is missing is all the extra stuff that make up a Web browser, such as a navigational toolbar. `WebView` does not provide any of that — if you want those sorts of UI features, you will need to implement those yourself (e.g., use an `EditText` or `AutoCompleteTextView` for a browser address bar).

## Supporting JavaScript

Now, you may be tempted to replace the URL in the above source code with something else, such as Google's home page or something else that relies upon JavaScript. You will find that such pages do not work especially well by default. That is because, by default, JavaScript is turned off in `WebView` widgets.

If you want to enable JavaScript, call `getSettings().setJavaScriptEnabled(true);` on the `WebView` instance. At this point, any JavaScript referenced by your Web page should work normally.

There are some fancy tricks you can perform with WebView and JavaScript, such as having JavaScript call Java code or vice versa. These techniques will be covered [in a later chapter](#).

## Alternatives for Loading Content

Instead of `loadUrl()`, you can also use `loadData()`. Here, you supply the HTML for the WebView to display. You might use this to:

1. display a manual that was installed as a file with your application package
2. display snippets of HTML you retrieved as part of other processing, such as the description of an entry in an Atom feed
3. generate a whole user interface using HTML, instead of using the Android widget set

There are two flavors of `loadData()`. The simpler one allows you to provide the content, the MIME type, and the encoding, all as strings. Typically, your MIME type will be `text/html` and your encoding will be `UTF-8` for ordinary HTML.

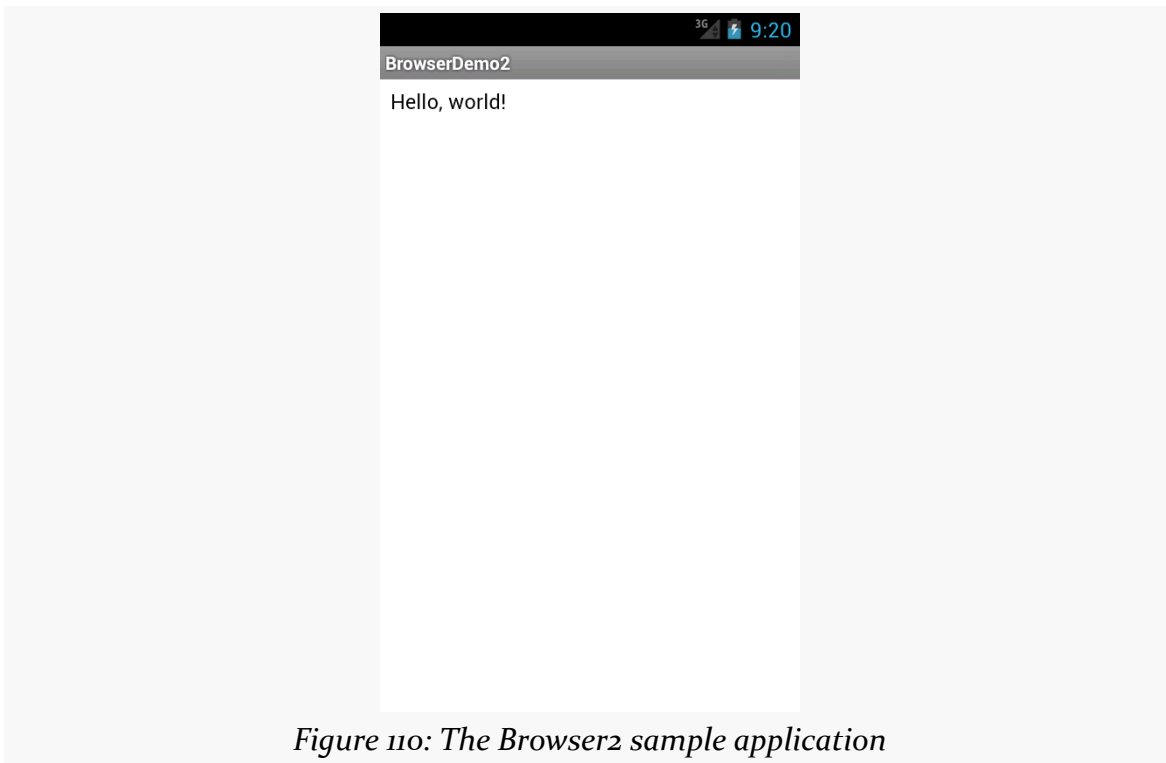
For example, if you replace the `loadUrl()` invocation in the previous example with the following:

```
browser.loadData("<html><body>Hello, world!</body></html>",  
                "text/html", "UTF-8");
```

You get:

## THE WEBVIEW WIDGET

---



*Figure 110: The Browser2 sample application*

This is also available as a fully-buildable sample, as [WebKit/Browser2](#).

There is also a `loadDataWithBaseURL()` method. This takes, among other parameters, the “base URL” to use when resolving relative URLs in the HTML. Any relative URL (e.g., ``) will be interpreted as being relative to the base URL supplied to `loadDataWithBaseURL()`. If you find that you have content that refuses to load properly with `loadData()`, try `loadDataWithBaseURL()` with a `null` base URL, as sometimes that works better, for unknown reasons.

## Listening for Events

Particularly if you are going to use the `WebView` as a local user interface (vs. browsing the Web), you will want to be able to get control at key times, particularly when users click on links. You will want to make sure those links are handled properly, either by loading your own content back into the `WebView`, by submitting an `Intent` to Android to open the URL in a full browser, or by some other means. We will discuss using an `Intent` to launch a Web browser [in a later chapter](#).

## THE WEBVIEW WIDGET

---

One hook into the `WebView` activity is via `setWebViewClient()`, which takes an instance of a `WebViewClient` implementation as a parameter. The supplied callback object will be notified of a wide range of events, ranging from when parts of a page have been retrieved (`onPageStarted()`, etc.) to when you, as the host application, need to handle certain user- or circumstance-initiated events, such as:

1. `onTooManyRedirects()`
2. `onReceivedHttpAuthRequest()`
3. etc.

A common hook will be `shouldOverrideUrlLoading()`, where your callback is passed a URL (plus the `WebView` itself) and you return `true` if you will handle the request or `false` if you want default handling (e.g., actually fetch the Web page referenced by the URL). In the case of a feed reader application, for example, you will probably not have a full browser with navigation built into your reader, so if the user clicks a URL, you probably want to use an `Intent` to ask Android to load that page in a full browser. But, if you have inserted a “fake” URL into the HTML, representing a link to some activity-provided content, you can update the `WebView` yourself.

For example, let’s amend the first browser example to be an application that, upon a click, shows the current time.

From [WebKit/Browser3](#), here is the revised Java:

```
package com.commonware.android.webkit;

import android.app.Activity;
import android.os.Bundle;
import android.text.format.DateUtils;
import android.webkit.WebView;
import android.webkit.WebViewClient;
import java.util.Date;

public class BrowserDemo3 extends Activity {
    WebView browser;

    @Override
    public void onCreate(Bundle icle) {
        super.onCreate(icle);
        setContentView(R.layout.main);
        browser=(WebView)findViewById(R.id.webkit);
        browser.setWebViewClient(new Callback());

        loadTime();
    }
}
```

## THE WEBVIEW WIDGET

---

```
void loadTime() {
    String page=
        "<html><body><a href='clock'>"
        + DateUtils.formatDateTime(this, new Date().getTime(),
            DateUtils.FORMAT_SHOW_DATE
            | DateUtils.FORMAT_SHOW_TIME)
        + "</a></body></html>";

    browser.loadData(page, "text/html", "UTF-8");
}

private class Callback extends WebViewClient {
    @Override
    public boolean shouldOverrideUrlLoading(WebView view, String url) {
        loadTime();

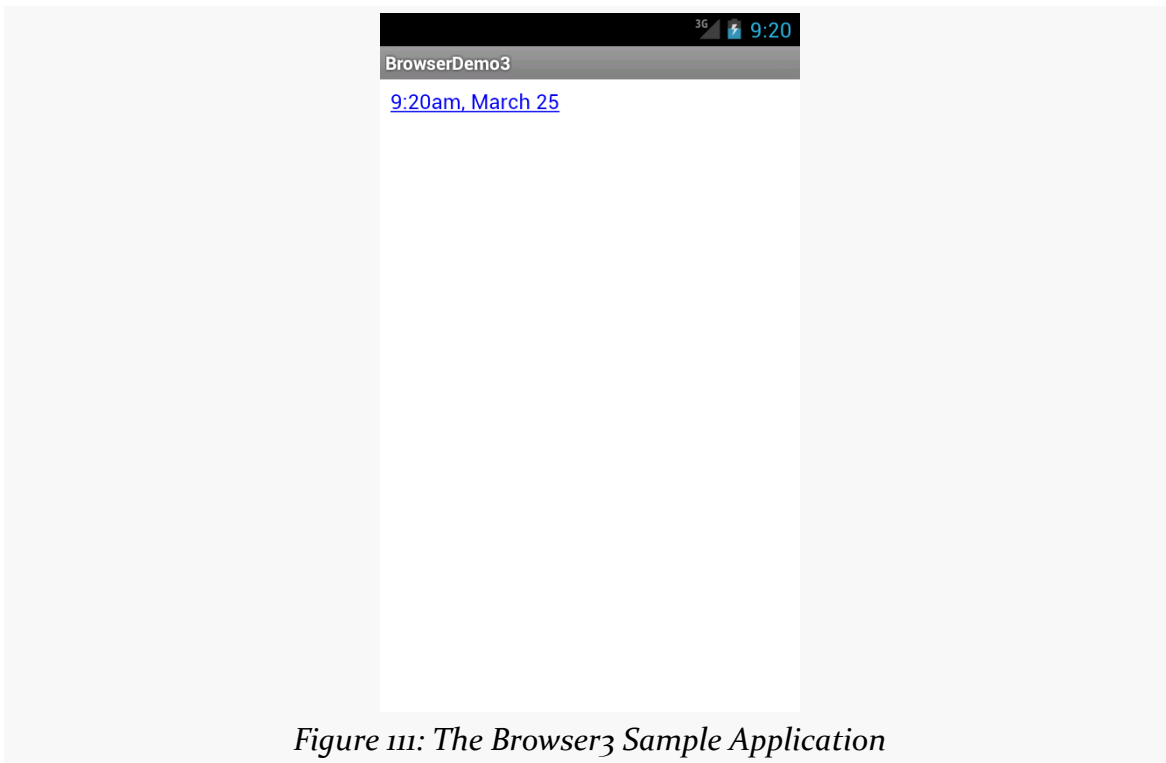
        return(true);
    }
}
```

Here, we load a simple Web page into the browser (`loadTime()`) that consists of the current time, made into a hyperlink to the `/clock` URL. We also attach an instance of a `WebViewClient` subclass, providing our implementation of `shouldOverrideUrlLoading()`. In this case, no matter what the URL, we want to just reload the `WebView` via `loadTime()`.

Running this activity gives us:

## THE WEBVIEW WIDGET

---



*Figure 111: The Browser3 Sample Application*

Selecting the link and clicking the D-pad center button will “click” the link, causing us to rebuild the page with the new time.

Note that we are using a `DateUtils` utility class supplied by Android for formatting our date and time. The big advantage of using `DateUtils` is that this class is aware of the user’s settings for how they prefer to see the date and time (e.g., 12- versus 24-hour mode).

There is also a `WebChromeClient` that you can register with a `WebView` via a call to `setWebChromeClient()`. This object will be called when various things occur in the `WebView` that might pertain to a browser’s “chrome” (i.e., the things outside the HTML rendering area). For example, `onJsAlert()` will be called on your `WebChromeClient` when JavaScript code calls `alert()`.

## Visit the Trails!

You can learn more about powerful tricks with `WebView`, including integrating the Java and JavaScript environments, in [a later chapter](#).

## THE WEBVIEW WIDGET

---

You can also create apps that run totally in the browser using [HTML5](#), or app frameworks that use `WebView` to render their UI, such as [PhoneGap](#).





# Defining and Using Styles

---

If you have done development using modern-day HTML, you will be familiar with Cascading Style Sheets (CSS). These provide two capabilities:

1. They let you define common characteristics of HTML elements in one place, applying them wherever as needed, to reduce repetition and simplify maintenance; and
2. They allow you to configure things about the HTML elements that pure HTML alone does not support

Android has similar constructs — styles and themes — for achieving similar ends. Styles and themes are another type of resource, akin to the layouts and strings and such that we have seen so far. Hence, the syntax of styles and themes is XML, rather than in CSS notation. However, the concepts and how they are employed are much like what you see with CSS.

This chapter will briefly explore the concept of styles, how you can create them, and how you can apply them to your own widgets.

## Styles: DIY DRY

The purpose of styles is to encapsulate a set of attributes that you intend to use repeatedly, conditionally, or otherwise wish to keep separate from your layouts proper. The primary use case is “don’t repeat yourself” (DRY) — if you have a bunch of widgets that look the same, use a style to use a single definition for “look the same”, rather than copying the look from widget to widget.

And that paragraph will make a bit more sense if we look at an example, specifically [the Styles/NowStyled sample project](#). This is a trivial project, with a full-screen

## DEFINING AND USING STYLES

---

button that shows the date and time of when the activity was launched or when the button was pushed. This time, though, we want to change the way the text on the face of the button appears, and we will do so using a style.

The `res/layout/main.xml` file in this project is the same as it was, with the addition of a style attribute:

```
<?xml version="1.0" encoding="utf-8"?>
<Button xmlns:android="http://schemas.android.com/apk/res/android"
    android:id="@+id/button"
    android:text=""
    android:layout_width="fill_parent"
    android:layout_height="fill_parent"
    style="@style/bigred"
/>
```

Note that the style attribute is part of stock XML and therefore is not in the android namespace, so it does not get the `android:` prefix.

The value, `@style/bigred`, points to a style resource. Style resources are values resources and can be found in the `res/values/` directory in your project, or in other resource sets (e.g., `res/values-v11/` for values resources only to be used on API Level 11 or higher). The convention is for styles resources to be held in a `styles.xml` file, such as the one from the `NowStyled` project:

```
<?xml version="1.0" encoding="utf-8"?>
<resources>
    <style name="bigred">
        <item name="android:textSize">30sp</item>
        <item name="android:textColor">#FFFF0000</item>
    </style>
</resources>
```

The `<style>` element supplies the name of the style, which is what we use when referring to the style from a layout. The `<item>` children of the `<style>` element represent values of attributes to be applied to whatever the style is applied towards — in our example, our `Button` widget. So, our `Button` will have a comparatively large font (`android:textSize` set to `30sp`) and have the text appear in red (`android:textColor` set to `#FFFF0000`).

There are no changes needed elsewhere in the project — nothing needs to be adjusted in the manifest, in the Java code of the activity, etc. Just defining the style and applying it to the widget gives us results:

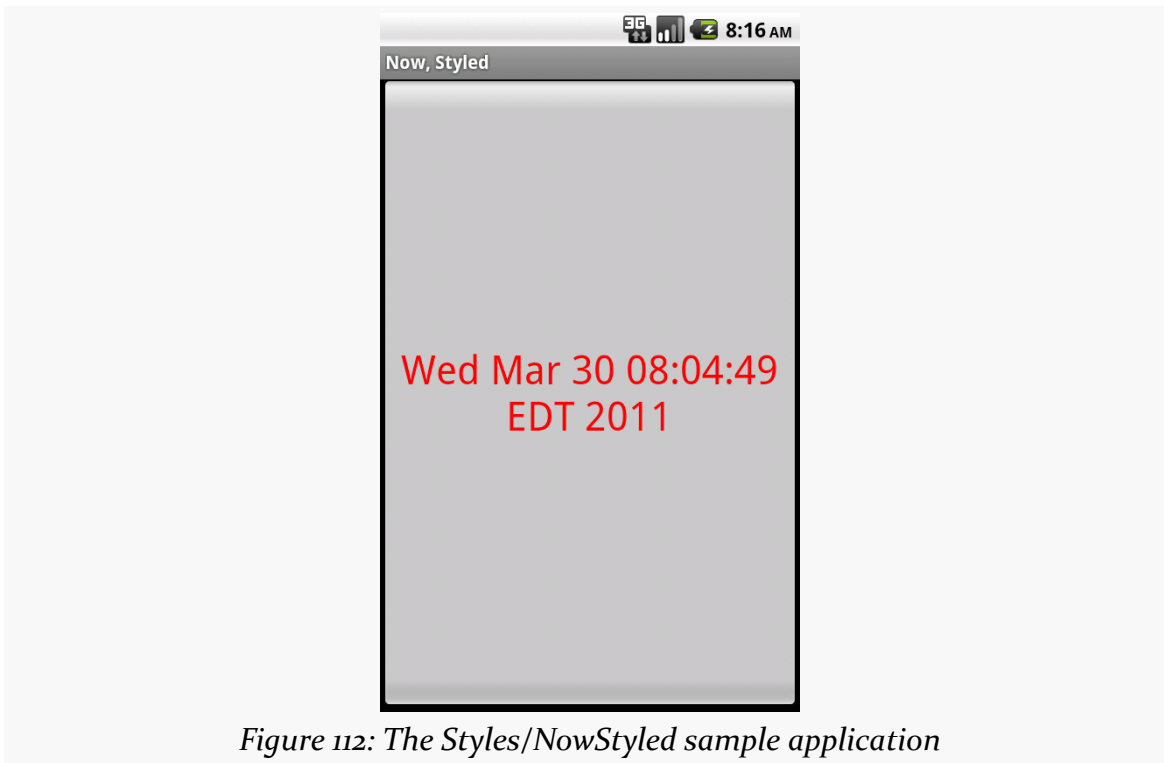


Figure 112: The Styles/NowStyled sample application

## Elements of Style

There are four elements to consider when applying a style:

- Where do you put the style attributes to say you want to apply a style?
- What attributes can you define via a style?
- How do you inherit from a previously-defined style (one of your own or one from Android)?
- What values can those attributes have in a style definition?

## Where to Apply a Style

The style attribute can be applied to a widget, to only affect that widget.

The style attribute can be applied to a container, to affect that container. However, doing this does not automatically style its children. For example, suppose `res/layout/main.xml` looked instead like this:

```
<?xml version="1.0" encoding="utf-8"?>
<LinearLayout xmlns:android="http://schemas.android.com/apk/res/android"
```

```
    android:layout_width="fill_parent"
    android:layout_height="fill_parent"
    style="@style/bigred">
<Button
    android:id="@+id/button"
    android:text=""
    android:layout_width="fill_parent"
    android:layout_height="fill_parent"
/>
</LinearLayout>
```

The resulting UI would not have the Button text in a big red font, despite the style attribute. The style only affects the container, not the contents of the container.

You can also apply a style to an activity or an application as a whole, though then it is referred to as a “theme”, which will be covered [a bit later in this chapter](#).

### The Available Attributes

When styling a widget or container, you can apply any of that widget’s or container’s attributes in the style itself. So, if it shows up in the “XML Attributes” or “Inherited XML Attributes” portions of the Android JavaDocs, you can put it in a style.

Note that Android will ignore invalid styles. So, had we applied the bigred style to the LinearLayout as shown above, everything would run fine, just with no visible results. Despite the fact that LinearLayout has no `android:textSize` or `android:textColor` attribute, there is no compile-time failure nor a runtime exception.

Also, layout directives, such as `android:layout_width`, can be put in a style.

### Inheriting a Style

You can also indicate that you want to inherit style attributes from another style, by specifying a parent attribute on the `<style>` element.

For example, take a look at this style resource:

```
<?xml version="1.0" encoding="utf-8"?>
<resources>
  <style name="activated" parent="android:Theme.Holo">
    <item name="android:background"?android:attr/
activatedBackgroundIndicator</item>
  </style>
</resources>
```

(note: in some renditions of this book, you may see the `<item>` element split over two lines — this is caused by word-wrapping, as this element should be all on one line)

Here, we are indicating that we want to inherit the `Theme.Holo` style from within Android. Hence, in addition to all of our own attribute definitions, we are specifying that we want all of the attribute definitions from `Theme.Holo` as well.

In many cases, this will not be necessary. If you do not specify a parent, your attribute definitions will be blended into whatever default style is being applied to the widget or container.

### The Possible Values

Typically, the value that you will give those attributes in the style will be some constant, like `30sp` or `#FFFF0000`.

Sometimes, though, you want to perform a bit of indirection — you want to apply some other attribute value from the theme you are inheriting from. In that case, you will wind up using the somewhat cryptic `?android:attr/` syntax, along with a few related magic incantations.

For example, let's look again at this style resource:

```
<?xml version="1.0" encoding="utf-8"?>
<resources>
  <style name="activated" parent="android:Theme.Holo">
    <item name="android:background">?android:attr/
activatedBackgroundIndicator</item>
  </style>
</resources>
```

Here, we are indicating that the value of `android:background` is not some constant value, or even a reference to a drawable resource (e.g., `@drawable/my_background`). Instead, we are referring to the value of some other attribute — `activatedBackgroundIndicator` — from our inherited theme. Whatever the theme defines as being the `activatedBackgroundIndicator` is what our background should be.

This portion of the Android style system is very under-documented, to the point where Google itself recommends you look at the [Android source code listing the various styles](#) to see what is possible.

This is one place where inheriting a style becomes important. In the example shown in this section, we inherited from `Theme.Holo`, because we specifically wanted the `activatedBackgroundIndicator` value from `Theme.Holo`. That value might not exist in other styles, or it might not have the value we want.

### Themes: Would a Style By Any Other Name...

Themes are styles, applied to an activity or application, via an `android:theme` attribute on the `<activity>` or `<application>` element. If the theme you are applying is your own, just reference it as `@style/...`, just as you would in a style attribute of a widget. If the theme you are applying, though, comes from Android, typically you will use a value with `@android:style/` as the prefix, such as `@android:style/Theme.Dialog` or `@android:style/Theme.Light`.

In a theme, your focus is not so much on styling widgets, but styling the activity itself. For example, here is the definition of `@android:style/Theme.NoTitleBar.Fullscreen`:

```
<!-- Variant of the default (dark) theme that has no title bar and  
fills the entire screen -->  
<style name="Theme.NoTitleBar.Fullscreen">  
  <item name="android:windowFullscreen">true</item>  
  <item name="android:windowContentOverlay">@null</item>  
</style>
```

It specifies that the activity should take over the entire screen, removing the status bar on phones (`android:windowFullscreen` set to `true`). It also specifies that the “content overlay” — a layout that wraps around your activity’s content view — should be set to nothing (`android:windowContentOverlay` set to `@null`), having the effect of removing the title bar.

# JARs and Library Projects

---

Java has as many, if not more, third-party libraries than any other modern programming language. Here, “third-party libraries” refer to the innumerable JARs that you can include in a server or desktop Java application — the things that the Java SDKs themselves do not provide.

In the case of Android, the Dalvik VM at its heart is not precisely Java, and what it provides in its SDK is not precisely the same as any traditional Java SDK. That being said, many Java third-party libraries still provide capabilities that Android lacks natively and therefore may be of use to you in your project, for the ones you can get working with Android’s flavor of Java. This chapter explains what it will take for you to leverage such libraries and the limitations on Android’s support for arbitrary third-party code.

You might think that JARs are the primary model of code reuse within Android. That’s not really the case. The primary model of code reuse within Android is the Android library project. Many reusable components and frameworks are distributed as library projects, and we will see several in the course of this book.

The example described in this chapter is the Android Support package, a key piece of reusable code from Google itself, distributed partly as JARs and partly as an Android library project.

But first, let’s talk a bit more about Dalvik.



### The Dalvik VM

When you are writing Android applications, you are writing Java source code. You might be thinking that your Android device is running Java bytecode, just as your Web browser might when it runs a Java applet.

Alas, you would be mistaken.

Android does not have a Java VM. Android has the Dalvik VM.

The Dalvik VM is a virtual machine, along the lines of the Java VM, the Parrot VM (Perl), Microsoft's CLR, and so forth. Since each VM has its own bytecode, the Dalvik VM bytecode is not the same as the Java VM bytecode (or the Parrot VM bytecode, etc.).

When you build your project, your Java source code is initially compiled using the standard `javac` compiler. Then, however, the Java VM bytecodes created by `javac` are cross-compiled into Dalvik VM bytecodes, and it is *those* bytecodes that are packaged into your APK file and are executed by Android.

Most of the time, you will not notice the difference. Every now and then, though, you will encounter some issues related to Android's use of Dalvik, and the most prominent of these comes when you try repurposing existing Java code.

### The Easy Part

You have two choices for integrating third-party Java code into your project: use source code, or use pre-packaged JARs.

If you choose to use their source code, all you need to do is copy it into your own source tree (under `src/` in your project), so it can sit alongside your existing code, then let the compiler perform its magic.

If you choose to use an existing JAR, perhaps one for which you do not have the source code, place the JAR in the `libs/` directory in your Android project.

And that's it, at least for Eclipse and Ant. Your JAR will be automatically added to your build path, and your JAR will be automatically bundled into the APK file that is your Android application. Note that other IDEs might require other steps – please consult the documentation for that IDE.

Hence, adding third-party code to your Android application is fairly easy.

Getting a library to actually *work* may be somewhat more complicated, however.

### The Outer Limits

Not all available Java code will work well with Android. There are a number of factors to consider, including:

1. *Expected Platform APIs*: Does the code assume a newer JVM than the one Android is based on? Or, does the code assume the existence of Java APIs that ship with J2SE but not with Android, such as Swing?
2. *Size*: Existing Java code designed for use on desktops or servers need not worry too much about on-disk size, or, to some extent, even in-RAM size. Android, of course, is short on both. Using third-party Java code, particularly when pre-packaged as JARs, may balloon the size of your application.
3. *Performance*: Does the Java code effectively assume a much more powerful CPU than what you may find on many Android devices? Just because a desktop can run it without issue does not mean your average mobile phone will handle it well.
4. *Interface*: Does the Java code assume a console interface? Or is it a pure API that you can wrap your own interface around?
5. *Operating System*: Does the Java code assume the existence of certain console programs? Does the Java code assume it can use a Windows DLL?
6. *Language Version*: Was the JAR compiled with an older version of Java (1.4.2 or older)? Was the JAR compiled with a different compiler than the official one from Sun (e.g., GCJ)? Was the JAR compiled with the new Java 7 release?
7. *Dependencies*: Does the Java code depend on other third-party JARs that might have some of these problems as well? Does the Java code depend upon third-party libraries (e.g., the org.json JSON library) that are built into Android, but the third party expects a different version of that library?

One trick for addressing some of these concerns is to use open source Java code, and actually work with the code to make it more Android-friendly. For example, if you are only using 10% of the third-party library, maybe it's worthwhile to recompile the subset of the project to be only what you need, or at least removing the unnecessary classes from the JAR. The former approach is safer, in that you get compiler help to make sure you are not discarding some essential piece of code, though it may be more tedious to do.

### OK, So What is a Library Project?

An Android library project is a special type of Android project designed to share code and resources between Android application projects. It is specifically aimed at developers or teams creating multiple applications from the same code base. The original occurrence of this pattern is the “paid/free” application pair: two applications, one offered for free, one with richer functionality that requires a payment. Via a library project, the common portions of those two applications can be consolidated, even if those “common portions” include things like resources. Library projects can also be used for reusable components, such as distributing custom widgets, activities, or frameworks to third parties.

The biggest difference between an Android library project and a JAR is that an Android library project is designed to distribute *resources* as well as Java code. If all you are looking to distribute is Java code, a JAR works just as well as an Android library project. But if you need to distribute layouts, themes, and the like, an Android library project is the solution.

### Creating a Library Project

An Android library project, in many respects, looks like a regular Android project. It has source code and resources. It has a manifest. It supports third-party JAR files (e.g., `libs/`).

What it does not do, though, is build an APK file. Instead, it represents a basket of programming assets that the Android build tools know how to blend in with regular Android projects.

To create a library project in Eclipse, start by creating a normal Android project. Then, in the project properties window (e.g., right-click on the project and choose Properties), in the Android area, check the “Is Library” checkbox. Click “Apply”, and you are done.

## JARS AND LIBRARY PROJECTS

---

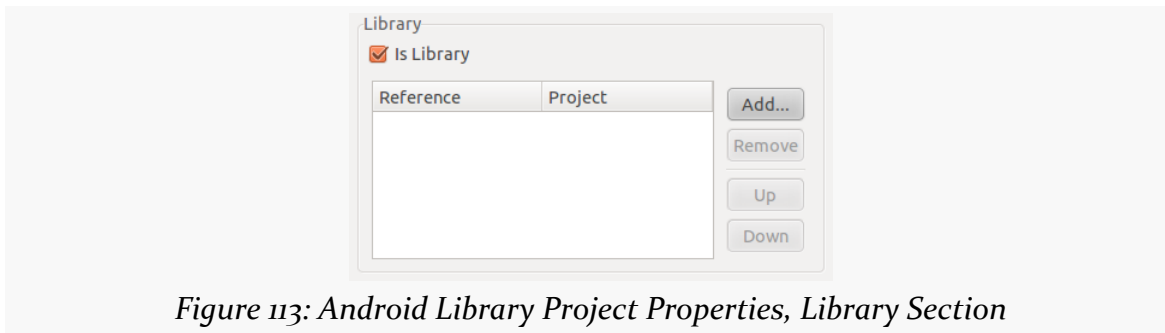


Figure 113: Android Library Project Properties, Library Section

To create a library project for use with Ant, you can use the `android create lib-project` command. This has the net effect of putting an `android.library=true` entry in your project's `project.properties` file.

## Using a Library Project

Once you have a library project, you can attach it to a regular Android project, so the regular Android project has access to everything in the library.

To do this in Eclipse, go into the project properties window (e.g., right-click on the project and choose Properties). Click on the Android entry in the list on the left, then click the “Add” button in the Library area. This will let you browse to the directory where your library project resides. You can add multiple libraries and control their ordering with the “Up” and “Down” buttons, or remove a library with the “Remove” button.

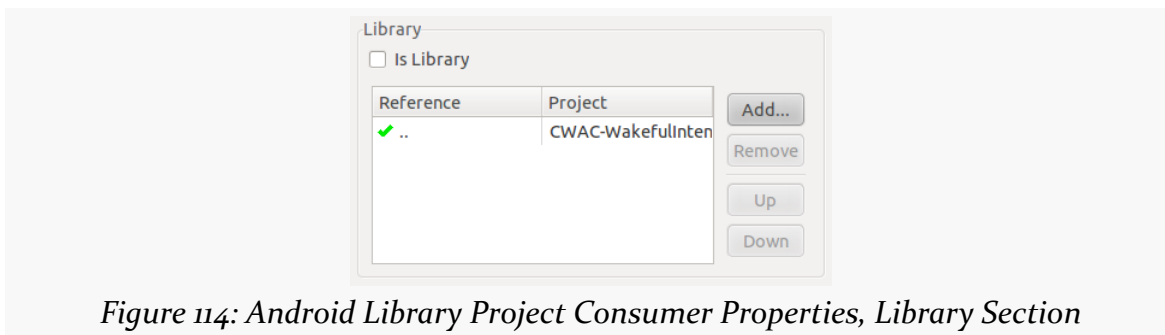


Figure 114: Android Library Project Consumer Properties, Library Section

For developing using Ant, you can use `android update project` command with the `--library` switch. This adds an entry like `android.library.reference.1=...` to your project's `project.properties` file, where ... is the relative path to your library project. You can add several such libraries, controlling their ordering via the numeric suffix at the end of each property name (e.g., 1 in the previous example).

Now, if you build the main project, the Android build tools will:

- Include the `src/` directories of the main project and all of the libraries (`libs/`) in the source being compiled.
- Include all of the resources of the projects, with the caveat that if more than one project defines the same resource (e.g., `res/layout/main.xml`), the highest priority project's resource is included. The main project is top priority, and the priority of the remainder are determined by their order as defined in Eclipse or `project.properties`.

This means you can safely reference R. constants (e.g., `R.layout.main`) in your library source code, as at compile time it will use the value from the main project's generated R class(es).

## Limitations of Library Projects

While library projects are useful for code organization and reuse, they do have their limits, such as:

- As noted above, if more than one project (main plus libraries) defines the same resource, the higher-priority project's copy gets used. Generally, that is a good thing, as it means that the main project can replace resources defined by a library (e.g., change icons). However, it does mean that two libraries might collide. It is important to keep your resource names distinct to minimize the odds of this occurrence.
- While you can define entries in the manifest file for a library, at present, they are not used.
- Since you are using the source code of the other project, you are subject to the limitations of its code. For example, if the third-party project is using `@Override` annotations on its implementations of interface methods, you will need to ensure that, in Eclipse, you have the compiler compliance level set to 1.6 — sometimes, this is set to 1.5, which complains about such annotations.

## The Android Support Package

The Android Support package is distributed by Google, containing classes (in JARs and an Android library project) that are not part of the Android SDK, but are available to Android developers.

### What's In There?

You can roughly divide the contents of the Android Support package into two major areas:

1. “Backports” of capabilities added to newer versions of Android and the Android SDK, so they can be used on older devices as well. By using the backported classes, you can get the same abilities on a wider range of devices than you could if you only used the classes in the Android SDK.
2. New widgets, containers, or other classes that are not going to be in the Android SDK (for ill-defined reasons) but that Google wishes to make available for Android developers.

### About the Names

What this book refers to as the “Android Support package” has many names.

It was originally referred to as the Android Compatibility Library, at a time when it only contained backports. Once they started adding in things that were not strictly related to “compatibility”, they started changing the name to try to be more generic. Right now, “Android Support” seems to be fairly consistent, either used standalone or in the form of “Android Support package” or “Android Support library”.

### Getting It

You will find the Android Support package in your SDK Manager, in the “Extras” category towards the bottom of the tree:

## JARS AND LIBRARY PROJECTS

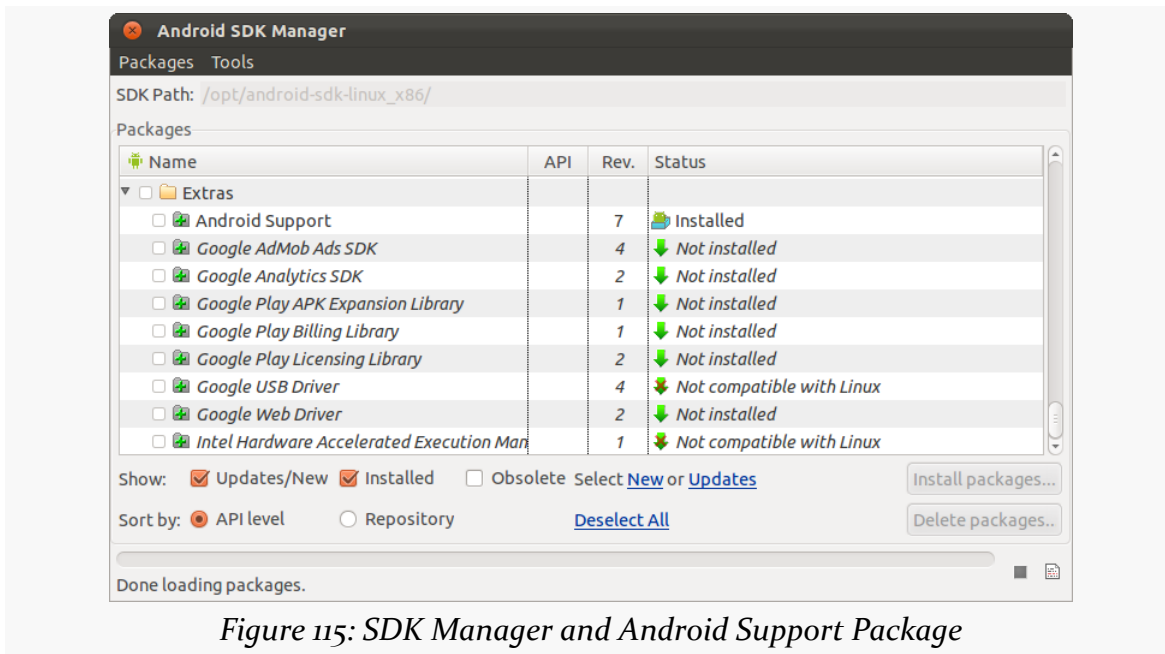


Figure 115: SDK Manager and Android Support Package

To install it, check the checkbox and click the “Install” button, just as you might install an SDK itself.

This will add an `extras/` directory to wherever your SDK installation resides, and the Android Support package will go into subdirectories inside of `extras/`.

### Attaching It To Your Project

From Eclipse, you can add the Android Support package to a project by right-clicking over the project and choosing `Android Tools > Add Support library` from the context menu.

Outside of Eclipse, you will want to find the `android-support-v4.jar` file installed in your `extras/` directory tree and add a copy to your project’s `libs/` directory. There is also an `android-support-v13.jar` and an Android library project associated with the Android Support package. However, unless specifically mentioned otherwise, this book will be referring to `android-support-v4.jar` when it refers to the Android Support package.

## JAR Dependency Management

Suppose we have Project A that depends on Library B and Library C, where the B and C are Android library projects. Further suppose that Project A, Library B, and Library C all need the Android Support package, so their projects are set up with access to it (e.g., having `android-support-v4.jar` in `libs/`).

You might think that we would somehow wind up with three copies of this support JAR in our APK. Fortunately, that is not the case. Android recognizes, based on filename, that these are the same JAR and therefore will only include one.

However, what happens if Google releases an update to the Android Support package, and you download the update?

Initially, nothing happens, if the support JARs are copied into your projects. If, however, you copy a fresh JAR into, say, Library C, without updating Library B or Project A, you will get a build error. Android will detect that while all three projects refer to the same JAR by name, the JARs themselves are different (based on SHA1 hash), and the build will fail. You will need to ensure that all three projects get the updated JAR.





# Tutorial #6 - Adding a Library

---

We will want to use a library named ActionBarSherlock in our project. This Android library project gives us a backwards-compatible edition of a UI construct known as the action bar, which we will examine in greater detail in [the next chapter](#). So, in this tutorial, we will download and set up ActionBarSherlock.

This is a continuation of the work we did in [the previous tutorial](#).

You can find [the results of the previous tutorial](#) and [the results of this tutorial](#) in [the book's GitHub repository](#).

## Step #1: Downloading and Unpacking ActionBarSherlock

Visit [the ActionBarSherlock](#) site and download the ZIP file (or tarball, if you prefer) from the home page for the current ActionBarSherlock release (4.2.0 at the time of this writing).

For the purposes of this tutorial, Eclipse users should take the `library/` directory out of the ZIP file and place it on your desktop, renaming it to `ActionBarSherlock/`. Non-Eclipse users should take the `library/` directory out of the ZIP file and place it in a directory parallel to your `EmPubLite/` directory, renaming `library/` to `ActionBarSherlock/`.

Note that a copy of a compatible version of ActionBarSherlock can be found in [the book's GitHub repository in its proper place relative to the EmPubLite projects](#).

**NOTE:** If your EmPubLite project has an `android-support-v4.jar` file in its `libs/` directory, the build tools will eventually complain about your project having

references to two different copies of that JAR — one from your project and one from ActionBarSherlock. The one in your project is probably newer than the one from ActionBarSherlock (which will use whatever JAR was included in `libs/` in the project's GitHub repo). Copy the `android-support-v4.jar` from your project's `libs/` directory into the `libs/` directory of ActionBarSherlock, so both projects work off of the same JAR contents.

## Step #2: Adding the Library to Your Project

Of course, merely downloading ActionBarSherlock does not somehow magically make it available to us. We need to add it to the EmPubLite project if we want to take advantage of its capabilities.

If you wish to make this change using Eclipse's wizards and tools, follow the instructions in the "Eclipse" section below. Otherwise, follow the instructions in the "Outside of Eclipse" section (appears after the "Eclipse" section).

### Eclipse

First, we need to create a second Eclipse project, this one to hold ActionBarSherlock. Since ActionBarSherlock does not ship with Eclipse project files, we will have to load it from source.

To do that:

- Choose File > New > Project... from the Eclipse main menu
- Choose "Android Project from Existing Code" from the list of project types and click "Next >"
- Click the "Browse..." button next to the "Root Directory" field, browse to the ActionBarSherlock directory you created above, then click OK
- Check the "Copy projects into workspace" checkbox
- Click "Finish" to create the project

If you see some red "X" error indicators over the `src/` and `res/` folders, right-click over the project and choose Properties from the context menu. In the Properties window, choose Android, then set the build target to API Level 14 or higher. Click "OK" to close up the Properties window. Then, from the Eclipse main menu, choose Project > Clean, ensure the ActionBarSherlock project is checked in the list of projects, and click "OK". This should eliminate the error indicators.

## TUTORIAL #6 - ADDING A LIBRARY

---

If you are still getting errors, and an examination of the ActionBarSherlock code indicates that the complaints are about `@Override` annotations on methods that are implementing an interface, rather than truly overriding a superclass method, you need to adjust your Eclipse compiler compliance level to be 1.6, instead of 1.5. Even if you already did this at the workspace level, you may need to do it at a project level. To do this:

1. Right click over the project name and choose Properties from the context menu
2. Click on “Java Compiler” in the tree on the left
3. Choose 1.6 from the “Compiler compliance level” drop-down
4. Click “Apply”, then “OK”

Note that if you use the [copy of ActionBarSherlock in this book's GitHub repository](#), then you can skip the above steps and just import the project directly into Eclipse (e.g., File > Import from the main menu).

To add the project as a library on EmPubLite, right-click over the EmPubLite project and choose Properties from the context menu. In the Properties window, choose Android, then click “Add...” in the Library group box, towards the bottom, on the right. In the list of library projects that appears, choose ActionBarSherlock, then click “OK”. The Library group box should then resemble the following:

## TUTORIAL #6 - ADDING A LIBRARY

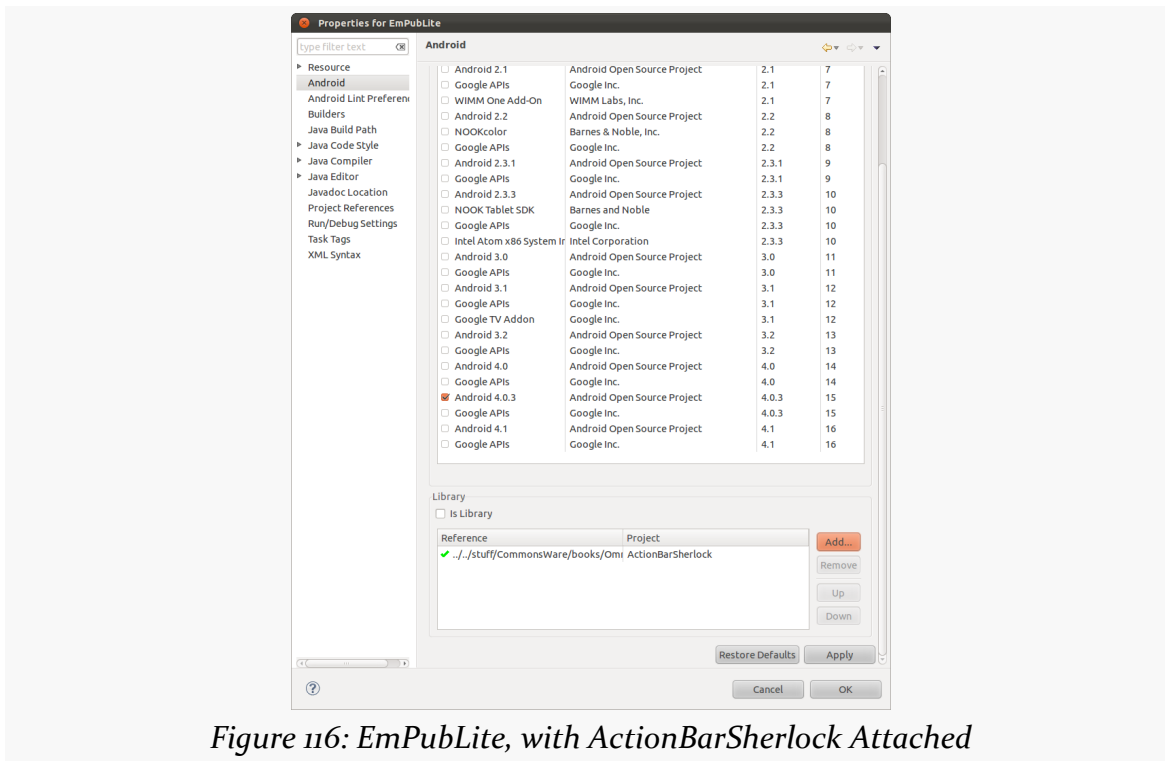


Figure 116: EmPubLite, with ActionBarSherlock Attached

Click “OK” to close up the Properties window.

### Outside of Eclipse

Switch to the EmPubLite project directory and run:

```
android update project --path . --library ../ActionBarSherlock
```

This tells Android to update your project .properties file to contain something resembling the following:

```
target=android-15
android.library.reference.1=../ActionBarSherlock
```

If your EmPubLite project has an android-support-v4.jar file in its libs/ directory, you may need to remove it, if Android complains about your project having references to two different copies of it — one from your project and one from ActionBarSherlock.

## In Our Next Episode...

... we will [configure the action bar](#) on our tutorial project



# Options Menus and the Action Bar

---

Like applications for the desktop and some mobile operating systems, Android supports activities with “application” menus. Some Android devices will have a dedicated MENU key for popping up the menu; other devices will offer alternate means for triggering the menu to appear, such as an on-screen soft button.

However, the preferred approach nowadays is to have your menu choices be part of what Android calls the action bar. The action bar is a strip across the top of your activity that provides users with ways of performing actions within that activity, such as toolbar buttons. While the action bar is only native to Android in Android 3.0 and higher, there are ways to get an action bar in Android 2.x devices as well, through an Android library project known as ActionBarSherlock.

## Bar Hopping (a.k.a., Terminology)

Android has had many patterns for various “bars” as part of its UI. So, to help explain what an action bar is, it helps if we review the history and role of Android’s various bars.

### Android 1.x/2.x

In the beginning, there was the status bar and the title bar.

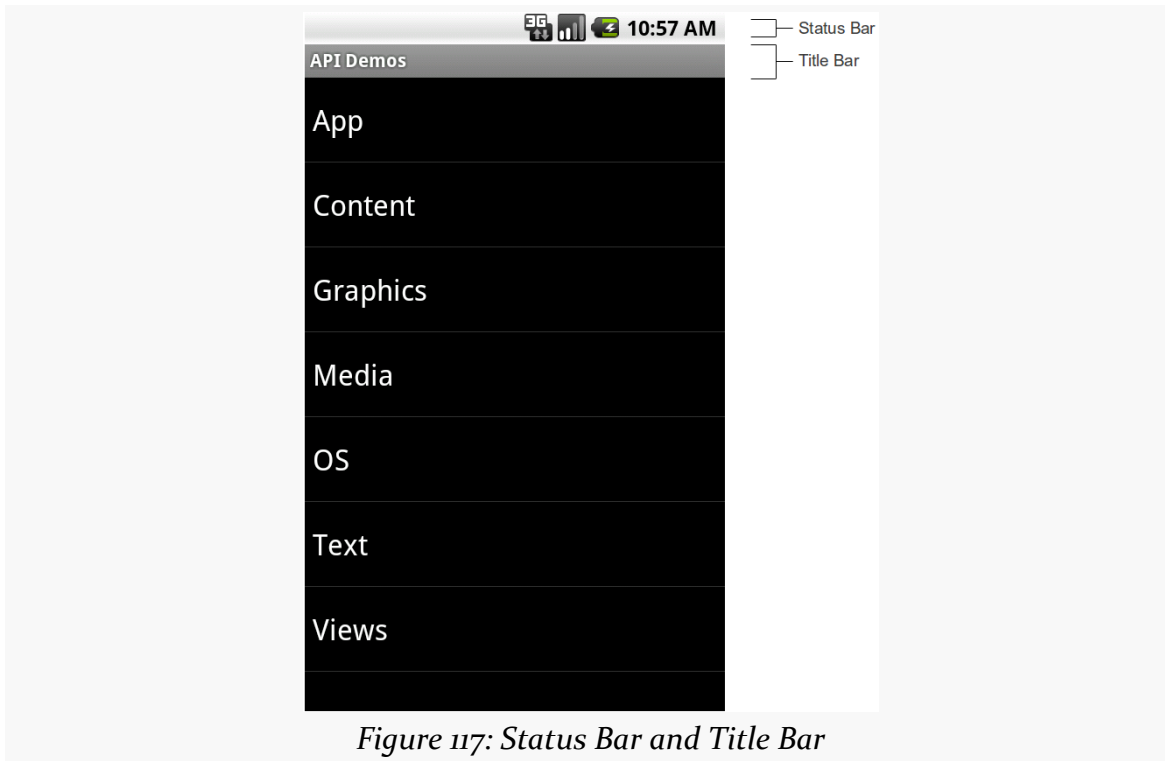
The status bar was a thin strip across the top of the screen, used for things like the clock, signal strength, battery charge, and notification icons (for events like new unread email messages). This bar is technically part of the OS, not your app’s UI.



## OPTIONS MENUS AND THE ACTION BAR

---

The title bar was a thin gray strip beneath the status bar that, by default, would hold the name of your application, much like the title bar of a browser might show the name of a Web site.



*Figure 117: Status Bar and Title Bar*

### Android 3.0–4.1, Tablets

When official support for tablets arrived with Android 3.0 in February 2011, the story changed.

The status bar was replaced by the system bar, appearing at the bottom of the screen. This had all of the contents of the old status bar, but also had the soft keys for BACK, HOME, etc. Android 1.x and 2.x required that devices have off-screen affordances for those operations; now, device manufacturers could skip those and have the system bar offer them.

The action bar, by default, appears at the top of your activity, replacing the old title bar. You can define what goes in the action bar (icon, title, toolbar buttons, etc.).

## OPTIONS MENUS AND THE ACTION BAR

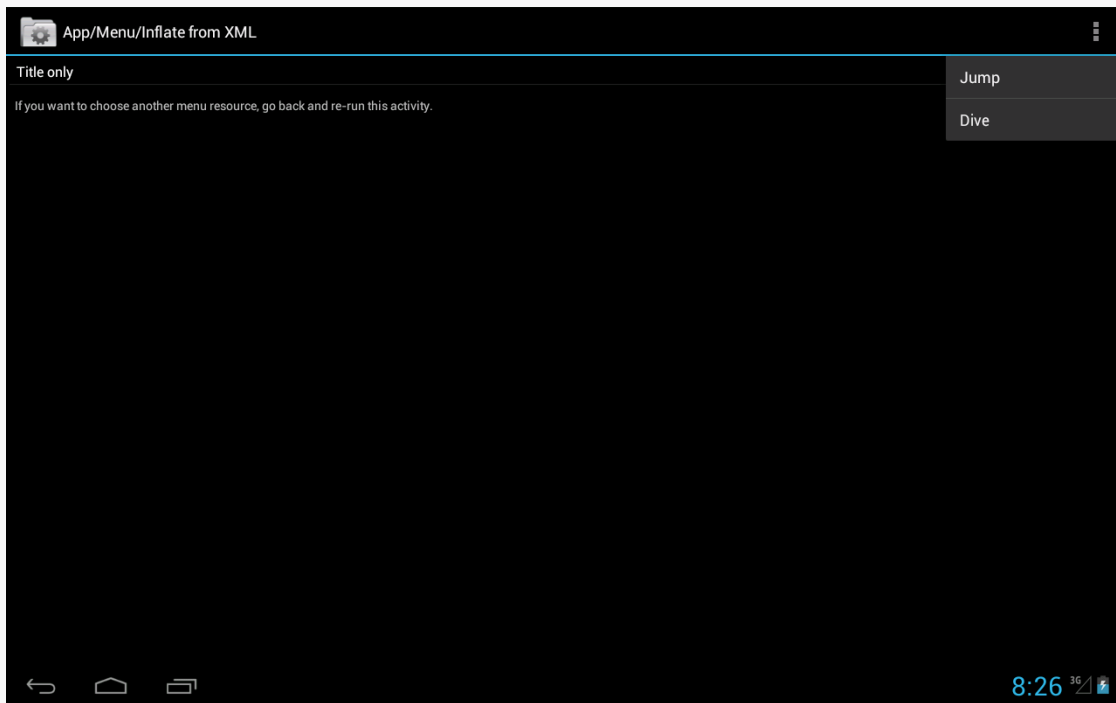
---



*Figure 118: Action Bar and System Bar*

The icon on the far left of the action bar also serves as a toolbar button, if you wish. A common pattern for using this is take the user back to the “main” or “home” activity of your application.

Sometimes, the far right side of the action bar will contain a “...” affordance. This is known as the “action overflow” or “overflow menu”:



*Figure 119: Action Bar with Open Overflow Menu*

Tapping it will give the user access to actions that might have been toolbar buttons on a larger screen, but there was insufficient room. Also, low-priority actions may be tucked into the overflow, rather than clutter up the screen with too many toolbar buttons.

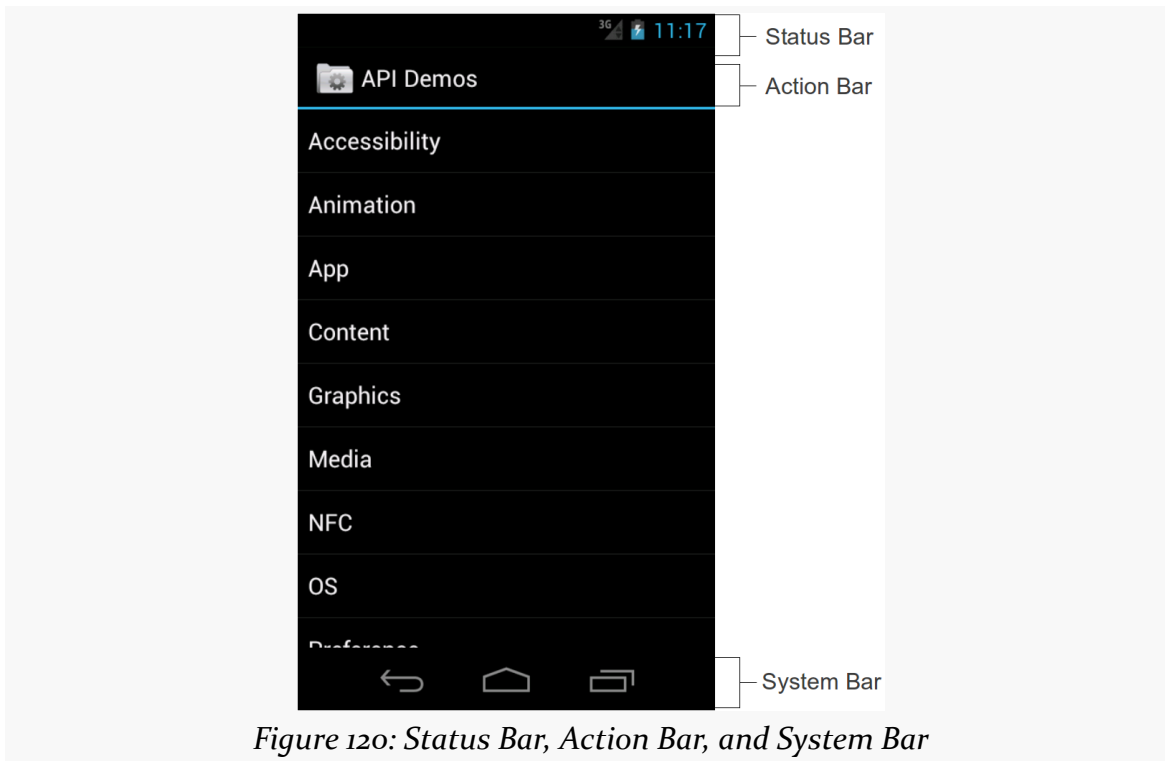
### **Android 4.0+, Phones**

Phone-sized devices were not supported by Android 3.x. They jumped from Android 2.3 to 4.0, and along the way adopted some of the Android 3.x UI features:

- Phone apps could have an action bar, like their tablet counterparts
- Device manufacturers could skip the BACK, HOME, etc. buttons and let a partial system bar handle those
- The status bar remained intact from the Android 2.x approach

## OPTIONS MENUS AND THE ACTION BAR

---



*Figure 120: Status Bar, Action Bar, and System Bar*

### Android 4.2, Tablets

The Nexus 7, introduced in the summer of 2012, was a 7" tablet that did not follow the tablet UI structure that all other standard Android tablets used. Instead, it looked a bit like a really large phone, having a top status bar along with a bottom system bar solely for the navigation buttons (BACK, HOME, etc.). Apps, as before, could have an action bar as well.

Initially, it was thought that the Nexus 7 was going to be distinctive in that regard. Instead, with Android 4.2, Google switched all tablets to this model, restoring the status bar and relegating the system bar purely for navigation buttons.

## OPTIONS MENUS AND THE ACTION BAR

---



*Figure 121: Status Bar, Action Bar, and System Bar, on Nexus 7 Emulator*

## Yet Another History Lesson

Back in the dawn of Android time, referred to by some as “the year 2007”, we had options menus. These would rise up from the bottom of the screen based on the user pressing a MENU button:



*Figure 122: Legacy Options Menu*

This is why you will see references to “options menu” scattered throughout the Android SDK and in (cough:) older Android books.

The action bar pattern was first espoused by Google at the 2010 Google I/O conference. However, at the time, there was no actual implementation of this, except in scattered apps, and definitely not in the Android SDK.

Android 3.0 — a.k.a., API Level 11 — added the action bar to the SDK, and apps targeting that API level will get an action bar when running on such devices.

## Your Action Bar Options

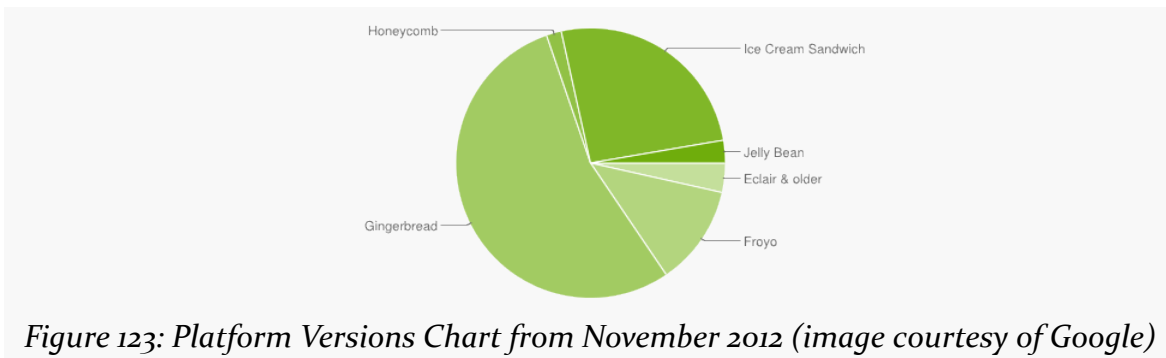
You have two ways of getting an action bar into your apps. In the long term, you will be able to simply use Android’s native implementation. In the short term, however, most likely you will want to use ActionBarSherlock.

### Pure Native

As mentioned above, devices running Android 3.0 and higher have support for the action bar as part of their firmware, and that support is exposed through the Android SDK. For example, there is an `ActionBar` class, and you can get an instance of it for your activity's action bar via `getActionBar()`.

However, this only works on devices running Android 3.0 and higher. If you try calling `getActionBar()` on an older device, you will crash with a `VerifyError` runtime exception. `VerifyError` is Android's way of telling you "while you compiled fine, something your compiled code refers to does not exist".

If your app will only ever run on Android 3.0 or higher devices, using the native action bar is a fine choice. However, at the time of this writing, relatively few devices run Android 3.0 and higher. You can find out how many devices are running various versions of Android via the "[Platform Versions](#)" portion of the "Device Dashboard" section of the Android Developers Web site. This is updated monthly and shows who is using what, in the form of a table and a pie chart:



Until a preponderance of devices runs Android 3.0 or higher, you would be stuck with the legacy options menus on older devices, and that would be sad.

### ActionBarSherlock

You might think that the Android Support package, with its focus on backports, would have some facility for adding an action bar to apps running on older devices. Alas, it does not.

Various third-party projects implemented action bars to try to fill this gap, and none has done nearly as well as has [ActionBarSherlock](#).

## OPTIONS MENUS AND THE ACTION BAR

---

ActionBarSherlock, in effect, extends the Android Support package, adding a backported action bar for apps running on devices prior to API Level 14 (Ice Cream Sandwich). While native action bars became available with API Level 11, there were enough differences that ActionBarSherlock uses its own implementation from API Level 13 on down to API Level 7 (Android 2.1).

To use ActionBarSherlock, you need to do a few things, above and beyond what you would ordinarily need to do to use the native action bar implementation.

### Installation

You will need to download ActionBarSherlock, such as by downloading a ZIP file or by cloning [the project's GitHub repository](#).

Inside of the ActionBarSherlock distribution is a `library/` directory, containing an Android library project that you will need to add to your application's project as described [in a previous chapter](#). We will go through all the steps of this process in an upcoming tutorial.

### Base Activity Class

You will need to adjust your project to inherit from `SherlockActivity` or one of its kin (e.g., `SherlockListActivity`). This is mostly a matter of adding the Sherlock prefix and adjusting your imports to refer to the `com.actionbarsherlock.app` package instead of `android.app`.

### Theme

You will also need to apply an ActionBarSherlock-flavored theme to your activities, either on a per-activity basis, or for the application as a whole. The Sherlock theme that most closely resembles the default theme is `Theme.Sherlock`.

The [ActionBar/ActionBarDemo](#) sample project applies `Theme.Sherlock` to the whole application, via an `android:theme` attribute on the `<application>` element:

```
<?xml version="1.0" encoding="utf-8"?>
<manifest xmlns:android="http://schemas.android.com/apk/res/android"
    package="com.commonware.android.inflation">

    <supports-screens
        android:anyDensity="true"
        android:largeScreens="true"
```



```
    android:normalScreens="true"
    android:smallScreens="true"/>

<uses-sdk
    android:minSdkVersion="7"
    android:targetSdkVersion="14"/>

<application
    android:icon="@drawable/ic_launcher"
    android:label="@string/app_name"
    android:theme="@style/Theme.Sherlock"
    android:uiOptions="splitActionBarWhenNarrow">
    <activity
        android:name=".ActionBarDemoActivity"
        android:label="@string/app_name">
        <intent-filter>
            <action android:name="android.intent.action.MAIN"/>

            <category android:name="android.intent.category.LAUNCHER"/>
        </intent-filter>
    </activity>
</application>

</manifest>
```

**NOTE:** If you use this sample app, or any other one that uses ActionBarSherlock, you will need to update its configuration to point to your own copy of ActionBarSherlock's Android library project.

### What We Will Be Doing

In this book, we will generally be using ActionBarSherlock. Right now, most developers should still be targeting Android 2.x devices, and that will remain the case well into 2013. By late 2013, Android 2.x may have a small enough user base that you could consider dropping ActionBarSherlock... assuming nothing new shows up that ActionBarSherlock fixes.

For apps that are only targeting API Level 11 or higher, you can elect to skip ActionBarSherlock and use the pure native action bar implementation. A few examples in this book — mostly ones that for other reasons only work on API Level 11+ — will go that route.

## Setting the Target

Whether you are using ActionBarSherlock or not, you will want to arrange to target API Level 11 or higher at runtime. That involves setting the `android:targetSdkVersion` attribute of the `<uses-sdk>` element of your manifest.

We see this in the same ActionBar/ActionBarDemo manifest originally shown above:

```
<?xml version="1.0" encoding="utf-8"?>
<manifest xmlns:android="http://schemas.android.com/apk/res/android"
    package="com.commonware.android.inflation">

    <supports-screens
        android:anyDensity="true"
        android:largeScreens="true"
        android:normalScreens="true"
        android:smallScreens="true"/>

    <uses-sdk
        android:minSdkVersion="7"
        android:targetSdkVersion="14"/>

    <application
        android:icon="@drawable/ic_launcher"
        android:label="@string/app_name"
        android:theme="@style/Theme.Sherlock"
        android:uiOptions="splitActionBarWhenNarrow">
        <activity
            android:name=".ActionBarDemoActivity"
            android:label="@string/app_name">
            <intent-filter>
                <action android:name="android.intent.action.MAIN"/>

                <category android:name="android.intent.category.LAUNCHER"/>
            </intent-filter>
        </activity>
    </application>
</manifest>
```

Specifically, we have `android:targetSdkVersion` set to 14. While 11 or higher will give you an action bar, 14 or higher will solve a particular UI quirk related to menu choices. Some Android 4.0+ devices, but not all, will show *two* ways of getting at overflow menu items if you have your `android:targetSdkVersion` set to a value between 11 and 13. You will have the “...” affordance in the action bar itself *and* a second one in the system bar, on devices that have one. Setting `android:targetSdkVersion` to 14 or higher seems to resolve this.

Doing nothing else but the preceding steps would give us an action bar, but one with no toolbar icons or action overflow menu. While perhaps visually appealing, this is not terribly useful for the user, so we need to do some more work to give the user actions to perform from the action bar.

### Minding Narrow

The native action bar debuted with Honeycomb, which was only available for tablets. Here, we had lots of room, even with the device in portrait mode.

Once Ice Cream Sandwich (Android 4.0) rolled around, and the native action bar became available for phones, it was readily apparent that it was too small in portrait mode to do very much.

To help with this, you can enable a mode for your application (or specific activities) that gives you a “split” action bar: one at the top of your activity, and another at the bottom. Your toolbar buttons and the action overflow area will appear at the bottom, leaving the top available for your icon, application name, and other stuff that we have not talked about just yet.

To enable this feature, add `android:uiOptions="splitActionBarWhenNarrow"` to your `<application>` or a specific `<activity>` in the manifest. In the sample application manifest shown above, you will see this in the `<application>` element. In Eclipse’s manifest editor, this appears as the “Ui options” field on the Application tab or in the details for a specific selected activity.

### Defining the Resource

The easiest way to get toolbar icons and action overflow items into the action bar is by way of a menu XML resource. This is called a “menu” resource for historical reasons, as these resources originally were used for things like the options menu.

You can add a `res/menu/` directory to your project and place in there menu XML resources.

Through Eclipse, if you create a new file in there (e.g., `actions.xml`), you will be able to manipulate the menu items using a structured editor, using the “Add” to add a new item and configuring it via the options on the right:

## OPTIONS MENUS AND THE ACTION BAR

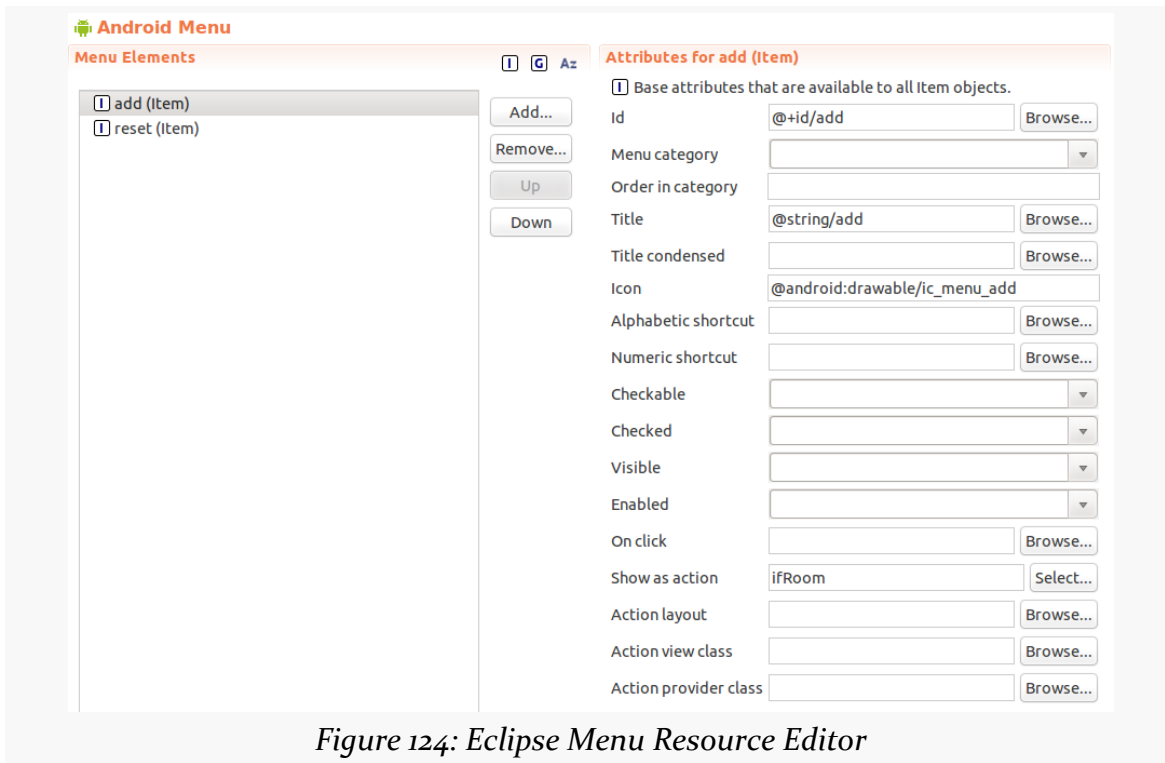


Figure 124: Eclipse Menu Resource Editor

Or, you can work with the raw XML, such as `res/menu/actions.xml` from `ActionBar/ActionBarDemo`:

```
<?xml version="1.0" encoding="utf-8"?>
<menu xmlns:android="http://schemas.android.com/apk/res/android">

  <item
    android:id="@+id/add"
    android:actionLayout="@layout/add"
    android:icon="@android:drawable/ic_menu_add"
    android:showAsAction="ifRoom"
    android:title="@string/add" />
  <item
    android:id="@+id/reset"
    android:icon="@android:drawable/ic_menu_revert"
    android:showAsAction="always|withText"
    android:title="@string/reset" />
  <item
    android:id="@+id/about"
    android:icon="@android:drawable/ic_menu_info_details"
    android:showAsAction="never"
    android:title="@string/about">
  </item>
</menu>
```

## OPTIONS MENUS AND THE ACTION BAR

---

There are four things you will want to configure on every menu item (`<item>` element in the XML):

1. The ID of the item (via the `Id` field in Eclipse or the `android:id` attribute in XML). This will create another `R.id` value, associated with this menu item, much like the `R.id` values for our widgets in our layouts. We will use this ID to determine when the user clicks on one of our toolbar buttons or action overflow items.
2. The title of the item (via the `Title` field in Eclipse or the `android:title` attribute in XML). If this item winds up in the action overflow menu, or optionally as part of its toolbar button, this text will appear. Typically, you will use a string resource reference (e.g., `@string/add`), to better support internationalization.
3. The icon for the item (via the `Icon` field in Eclipse or the `android:icon` attribute in XML). If your item will appear as a toolbar button, this icon is used with that button.
4. Flags indicating how this item should be portrayed in the action bar (via the “Show as action” field in Eclipse or the `android:showAsAction` attribute in XML). You will choose to have it be always a toolbar button, only be a toolbar button `ifRoom`, or have it never be a toolbar button. You can also elect to append `|withText` to either `always` or `ifRoom`, to indicate that you want the toolbar button to be both the icon and the title, not just the icon.

### Pondering Our Icons

There are three major sources of icons for your toolbar buttons:

1. Icons that are part of the Android SDK itself. You will find these listed in the documentation for `android.R.drawable` in the Android JavaDocs — icons for toolbar buttons are prefixed with `ic_menu_`. You would refer to these in your menu XML resource as `@android:drawable/...`, where the `...` is the name of the drawable resource. The `android:portion` indicates that you are trying to pull an image from the SDK. The `ActionBar/ActionBarDemo` resource shown above uses this approach to pull in `@android:drawable/ic_menu_add` and `@android:drawable/ic_menu_revert`.
2. Icons that are part of the firmware but are not exposed via the Android SDK. You can find many of these in your SDK installation — go to the `platforms` directory, choose a particular installed SDK version (e.g., `android-11`), then go into `data/res/` and a particular drawable resource set (e.g., `drawable-hdpi`), and you will see many icons. Those with `ic_menu_` prefixes are designed to work with action bars. However, since these are not part of

- the SDK, you will need to copy them (in all relevant densities) into your project. And, since styling of these icons may have changed between various Android SDK releases, you may find that you need to copy a few versions of the icons and place them in API-level-specific resource sets (e.g., `res/drawable-hdpi-v11/` for icons to be used on API Level 11 and higher).
- Icons that you draw yourself, or hire a graphic designer to draw, or obtain from the [Android Asset Studio](#), or otherwise download. You will find [instructions in the Android Developer documentation](#) for how to design suitable icons, with the instructions written with a Photoshop user in mind.

The riskiest of these is using the built-in icons (#1 above). The reason is that device manufacturers have a tendency to tinker with these icons, changing their look from what you will see in the SDK and emulators. If *all* of the icons you will use come from the firmware, this is not going to be a problem. If, however, you are mixing some built-in icons with icons from other sources (#2 or #3 above), you will wind up with a mixed bag of looks. For example, some device manufacturers colorize their icons, while the standard Android icons are all grayscale — you might wind up with some grayscale icons and some in full color, which will look odd to your users. Hence, while it is cheap and easy to use the built-in icons, beware of this risk.

### Action Layouts

What happens if you want something other than a button to appear in the toolbar? Suppose you want a field instead?

Fortunately, this is supported. Otherwise, this would be a completely pointless section of the book.

In addition to the menu item configuration options mentioned above, you can also specify `android:actionLayout` (the “Action layout” field in Eclipse). This will be a reference to a layout XML resource that you want to have inflated into the action bar instead of a toolbar button. Obviously, since the action bar is only so big, you will need to be judicious about your use of space, which is why the `res/layout/add.xml` resource, referred to from our “add” item, is just a `LinearLayout` holding onto a `TextView` label and an `EditText` field:

```
<?xml version="1.0" encoding="utf-8"?>
<LinearLayout xmlns:android="http://schemas.android.com/apk/res/android"
    android:layout_width="fill_parent"
    android:layout_height="wrap_content"
    android:orientation="horizontal">
```

```
<TextView
  android:layout_width="wrap_content"
  android:layout_height="wrap_content"
  android:text="Word:"
  android:textAppearance="@android:style/TextAppearance.Medium"/>

<EditText
  android:id="@+id/title"
  android:layout_width="0px"
  android:layout_weight="1"
  android:layout_height="wrap_content"
  android:layout_marginLeft="4dip"
  android:layout_marginTop="4dip"
  android:imeActionId="1337"
  android:imeOptions="actionDone"
  android:inputType="text"
  android:width="100sp"/>

</LinearLayout>
```

Some notable features of our layout include:

1. We add an `android:textAppearance` attribute to the `TextView` representing our “Add:” caption. The `android:textAppearance` attribute allows us to define the font type, size, color, and weight (e.g., bold) in one shot. We specifically use a “magic value” of `@android:style/TextAppearance.Medium`, so the caption matches the styling of the “Reset” label on our other menu item we promoted to the action bar.
2. We specify `android:width="100sp"` for the `EditText` widget, to provide room for other contents within our split action bar.
3. We specify `android:inputType="text"` on the `EditText` widget, which, among other things, will restrict us to a single line of text.
4. We also specify `android:imeActionId` and `android:imeOptions` on the `EditText` widget to control the “action button” of the soft keyboard, so we get control when the user presses <Enter> on the soft keyboard.

So, given our menu resource XML listed earlier in this chapter, we are requesting:

- A custom action view (`@layout/add`), if there is room, and
- An action overflow item, named `@id/reset`

## Applying the Resource

From your activity, you teach Android about these action bar items by overriding an `onCreateOptionsMenu()` method, such as this one from the `ActionBarDemoActivity` of the `ActionBar/ActionBarDemo` sample project:

```
@Override
public boolean onCreateOptionsMenu(Menu menu) {
    new MenuInflater(this).inflate(R.menu.actions, menu);

    configureActionItem(menu);

    return(super.onCreateOptionsMenu(menu));
}
```

Here, we create a `MenuInflater` and tell it to inflate our menu XML resource (`R.menu.actions`) and pour them into the supplied `Menu` object. We then chain to the superclass, returning its result. We will discuss that `configureActionItem()` method call [shortly](#).

Note that the specific implementations of `Menu` and `MenuInflater` will depend upon whether you are using `ActionBarSherlock` or not — if you are, you will need to use the `Sherlock` versions (`com.actionbarsherlock.view.Menu` and `com.actionbarsherlock.view.MenuInflater`) instead of the standard Android SDK ones (`android.view.Menu` and `android.view.MenuInflater`).

## Responding to Events

To find out when the user taps on one of these things, you will need to override `onOptionsItemSelected()`, such as the `ActionBarDemoActivity` implementation shown below:

```
@Override
public boolean onOptionsItemSelected(MenuItem item) {
    if (item.getItemId() == R.id.reset) {
        initAdapter();
        return(true);
    }

    return(super.onOptionsItemSelected(item));
}
```

You will be passed a `MenuItem` (either `android.view.MenuItem` or `com.actionbarsherlock.view.MenuItem`). You can call `getItemId()` on it and



compare that value to the ones from your menu XML resource (`R.id.add` and `R.id.reset`). If you handle the event, return `true`; otherwise, return the value of chaining to the superclass' implementation of the method.

If you wish to respond to taps on your application icon, on the left of the action bar, compare `getItemId()` to `android.R.id.home`, as that will be the `MenuItem` used for that particular toolbar button. Note that if you have your `android:targetSdkVersion` set to 14 or higher, you will also need to call `setHomeButtonEnabled(true)` on the `ActionBar` (obtained via a call to `getActionBar()` or `getSupportActionBar()`, depending on whether you are using `ActionBarSherlock`), to enable this behavior.

## Attaching to Action Layouts

This works nicely for our reset action overflow item. What about that other menu item, where we requested our custom action view layout?

That is where that `configureActionItem()` method comes into play, that we called from `onCreateOptionsMenu()`:

```
private void configureActionItem(Menu menu) {
    EditText add=
        (EditText)menu.findItem(R.id.add).getActionView()
            .findViewById(R.id.title);

    add.setOnEditorActionListener(this);
}
```

Here, we ask the `Menu` to find the `MenuItem` object associated with our given item ID (`@id/add`). We then retrieve our inflated layout by a call to `getActionView()`. Finally, we get at the `EditText` widget by means of our old standby, `findViewById()`. Note that we have to call `findViewById()` on the inflated layout, not the activity.

Given this widget, we can now configure it as we see fit. In this case, we call `setOnEditorActionListener()`, indicating to Android that we want to get control when the user presses `<Enter>` or clicks the action button in the lower right corner of most soft keyboards. We will see what we do on that event shortly.

## The Rest of the Sample Activity

So, what is it that we really are doing here in `ActionBarDemoActivity`?

## OPTIONS MENUS AND THE ACTION BAR

---

In many respects, this is reminiscent of the `ListActivity` demos from [an earlier chapter](#). We have an array of 25 nonsense words, and we want to display these in a list. However, in addition, we want to allow the user to add words to the list and revert the list to its original state.

`ActionBarDemoActivity` is a `SherlockListActivity` — an `ActionBarSherlock` equivalent of the `ListActivity`. However, rather than set up our `ArrayAdapter` directly in the `onCreate()` method as some of the other samples have done, we delegate that work to an `initAdapter()` method. Moreover, that `initAdapter()` method does its work a bit differently than what those other samples did:

```
private void initAdapter() {
    words=new ArrayList<String>();

    for (String s : items) {
        words.add(s);
    }

    adapter=
        new ArrayAdapter<String>(this,
                                android.R.layout.simple_list_item_1,
                                words);

    setListAdapter(adapter);
}
```

Rather than create the `ArrayAdapter` straight out of the static `items` array, we create a fresh `ArrayList` and pour the `items` into it, then create the `ArrayAdapter` on the `ArrayList`. This may seem superfluous, but we will take advantage of this approach with our action bar items.

When the user clicks the `Reset` item in the action overflow menu, we call `initAdapter()` again, which gives our `ListActivity` a fresh set of nonsense words to display:

```
@Override
public boolean onOptionsItemSelected(MenuItem item) {
    if (item.getItemId() == R.id.reset) {
        initAdapter();
        return(true);
    }

    return(super.onOptionsItemSelected(item));
}
```

When the user presses <Enter> or clicks the “Done” button on the soft keyboard while typing in our `EditText`, control routes to our activity’s `onEditorAction()`

## OPTIONS MENUS AND THE ACTION BAR

---

method, which is required of a `TextView.OnEditorActionListener`, which itself is required because we are supplying the activity as the parameter to `setOnEditorActionListener()`:

```
@Override
public boolean onEditorAction(TextView v, int actionId, KeyEvent event) {
    if (event == null || event.getAction() == KeyEvent.ACTION_UP) {
        adapter.add(v.getText().toString());
        v.setText("");

        InputMethodManager imm=
            (InputMethodManager) getSystemService(INPUT_METHOD_SERVICE);

        imm.hideSoftInputFromWindow(v.getWindowToken(), 0);
    }

    return(true);
}
```

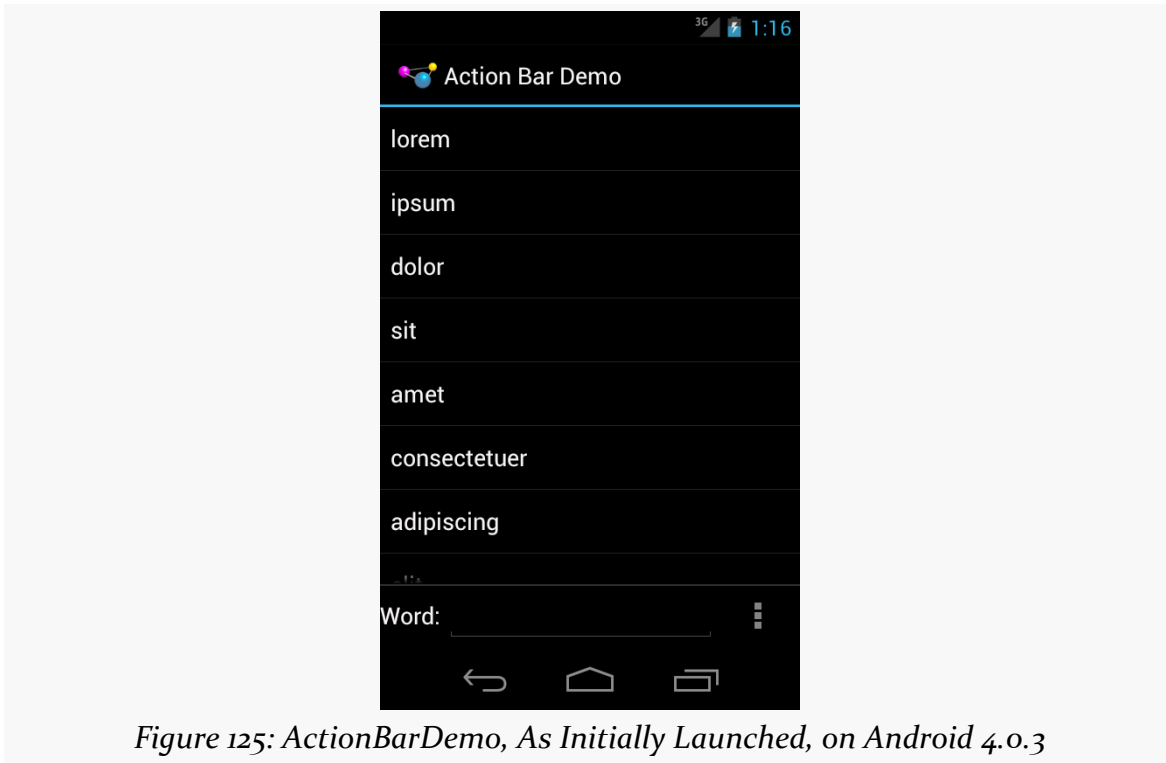
We know the user has completed entering a word when `onEditorAction()` is invoked and the supplied `KeyEvent` is null or is `ACTION_UP` (meaning the user lifted their finger off of the key). At that point, we do three things:

1. We grab the nonsense word out of the field (supplied to us as a `TextView` parameter to `onEditorAction()`) and we `add()` it to our `ArrayAdapter`. The `add()` method appends this word to the end of the words in our list. This works because we used an `ArrayList` for the `ArrayAdapter`, and `ArrayList` objects' contents can be modified at runtime (unlike static string arrays). A side effect of calling `add()` is that the `ArrayAdapter` will tell its attached `ListView` that the contents of the list changed, so the `ListView` will redraw itself and our new word appears at the bottom.
2. We clear out the field, so the user knows that we have accepted the new word.
3. We use the `InputMethodManager` to hide the soft keyboard, which will not automatically go away if the user presses <Enter>.

The net result of all of this is that we have an activity with our customized action bar:

## OPTIONS MENUS AND THE ACTION BAR

---



*Figure 125: ActionBarDemo, As Initially Launched, on Android 4.0.3*

where the user can also type in a nonsense word into the field:

## OPTIONS MENUS AND THE ACTION BAR

---

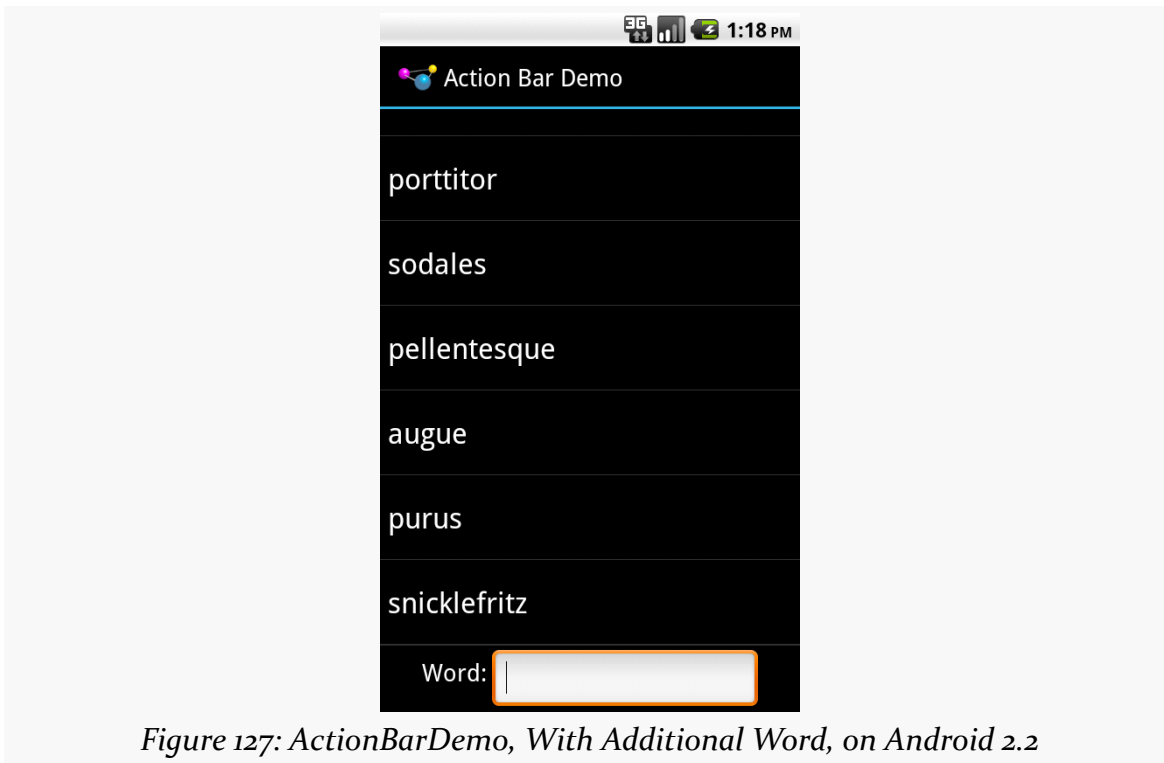


*Figure 126: ActionBarDemo, With User Data Entry, on Android 2.2*

If the user presses <Enter> or clicks that “Done” button in the lower right corner of the soft keyboard, the nonsense word is added to the end of the list:

## OPTIONS MENUS AND THE ACTION BAR

---



*Figure 127: ActionBarDemo, With Additional Word, on Android 2.2*

Among our action bar items is an “About” one that will always be in the overflow menu. This will have three possible visual outcomes.

First, on devices without an off-screen MENU button, the overflow menu is represented by a “...” button, which displays the overflow menu when clicked:

## OPTIONS MENUS AND THE ACTION BAR

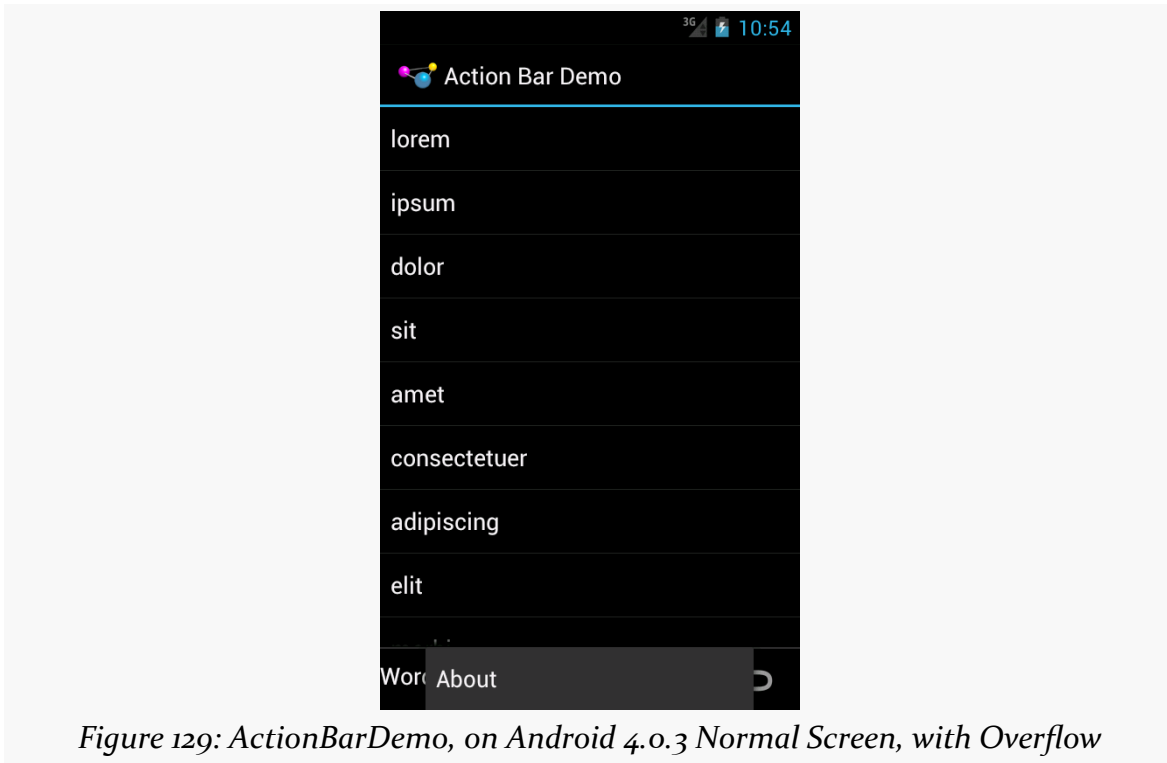


*Figure 128: ActionBarDemo, on Android 4.0.3 Large Screen, with Overflow*

On Android 4.x devices with an off-screen MENU button, pressing the MENU button will cause the overflow menu to rise up from the bottom of the screen:

## OPTIONS MENUS AND THE ACTION BAR

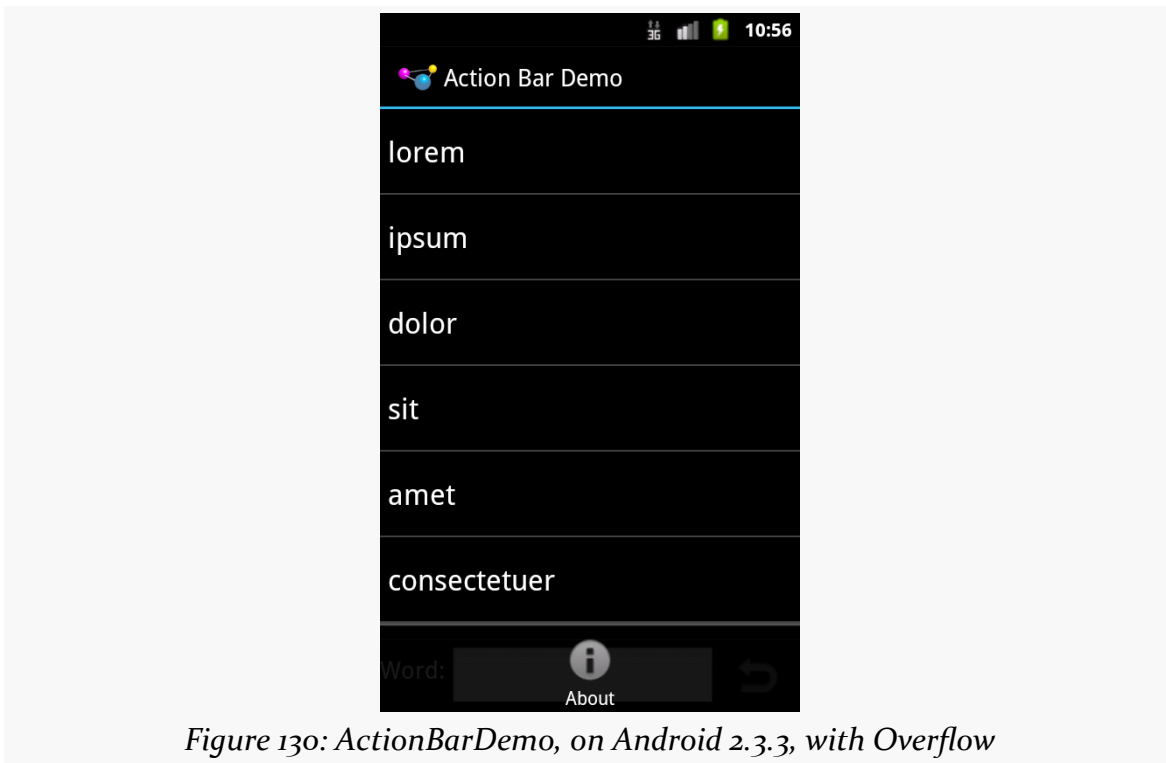
---



*Figure 129: ActionBarDemo, on Android 4.0.3 Normal Screen, with Overflow*

Finally, on Android 2.x devices, pressing the MENU button will cause a classic options menu to appear:





*Figure 130: ActionBarDemo, on Android 2.3.3, with Overflow*

## Floating Action Bars

By default, your action bar (or action bars, if you are using `splitActionBarWhenNarrow`) will be separate from the main content area of your activity. Normally, that is what you want.

But, sometimes, you may want to have the action bar(s) float over top of your activity, as can be seen in Google Maps:

## OPTIONS MENUS AND THE ACTION BAR

---

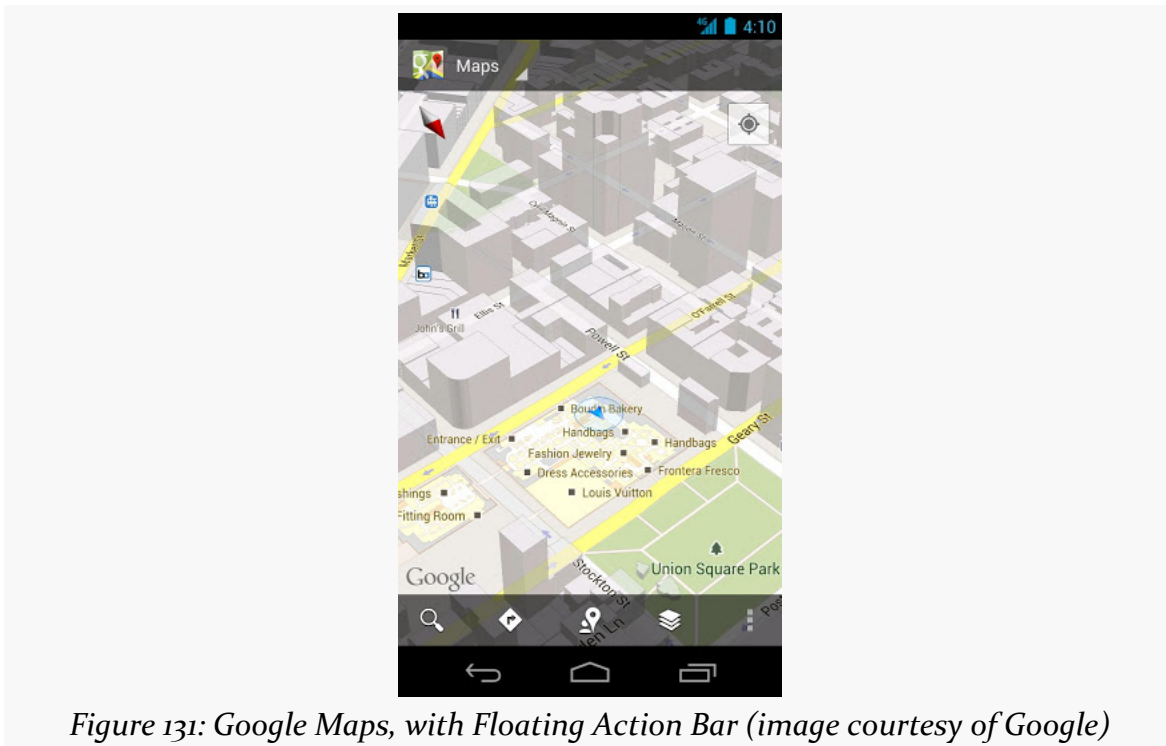


Figure 131: Google Maps, with Floating Action Bar (image courtesy of Google)

To accomplish this, you can use `FEATURE_ACTION_BAR_OVERLAY`, as is illustrated in the [ActionBar/Overlay](#) sample project.

This is nearly identical to the `ActionBar/ActionBarDemo` sample project, with just a few changes, mostly in the `onCreate()` method of our activity:

```
@Override
public void onCreate(Bundle savedInstanceState) {
    super.onCreate(savedInstanceState);

    getWindow().requestFeature(Window.FEATURE_ACTION_BAR_OVERLAY);

    initAdapter();

    Drawable d =
        getResources().getDrawable(R.drawable.action_bar_background);

    getSupportActionBar().setBackgroundDrawable(d);
    getSupportActionBar().setSplitBackgroundDrawable(d);
}
```

In addition to the original logic, we:

## OPTIONS MENUS AND THE ACTION BAR

---

- Call `requestFeature()` on our `Window` (obtained via a call to `getWindow()`), asking for `FEATURE_ACTION_BAR_OVERLAY`
- Call `setBackgroundDrawable()` on our `ActionBar` (obtained via a call to `getSupportActionBar()`), since we are using `ActionBarSherlock`, supplying a reference to a drawable resource to use for the background of the floating action bar
- Call `setSplitBackgroundDrawable()` on our `ActionBar` to set the same drawable resource for the background of the bottom action bar, if and when one is used

The drawable resource is a `ShapeDrawable`, defined in XML:

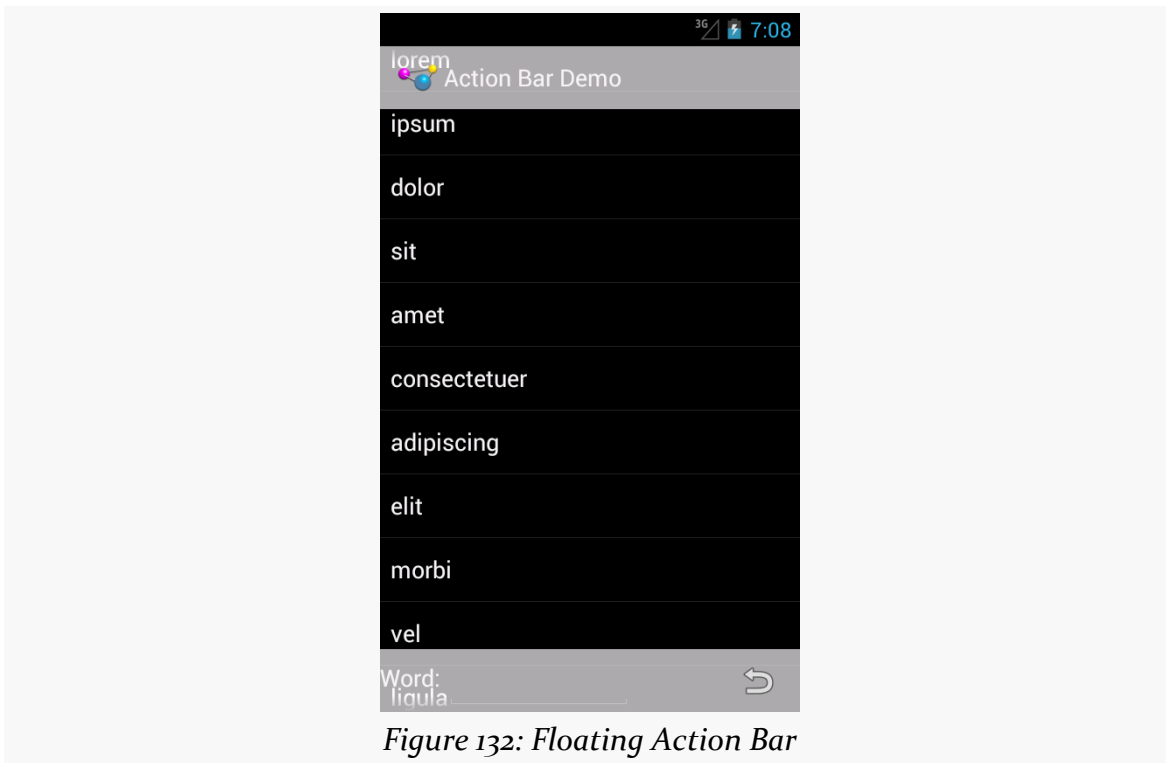
```
<?xml version="1.0" encoding="utf-8"?>
<shape xmlns:android="http://schemas.android.com/apk/res/android"
    android:shape="rectangle">

    <solid android:color="#AFFFFFFF"/>

</shape>
```

We will discuss `ShapeDrawable` in much greater detail [later in this book](#) . For the moment, take it on faith that our resource is defining a rectangle, with a translucent white fill. The alpha channel (AA) for our translucence is important, so the user can see a bit of our activity underneath the floating action bar.

The result is that our action bars float over top of the list:



*Figure 132: Floating Action Bar*

In this case, the effect is not very good, as the words will blend in too strongly with the overlaid action bars. However, that is a question of organizing the screen content and using this overlay feature only in cases where you will see good results, such as in the Google Maps example shown above.

## Visit the Trails!

In addition to this chapter, you can [learn more about navigation options in the action bar \(e.g., tabs\)](#) and [learn about action modes](#), which temporarily replace the action bar with new items for use with contextual operations.



# Tutorial #7 - Adding the Action Bar

---

Now that we have added ActionBarSherlock to our project, it is time to put it to use, adding the action bar to our EmPubLite application.

This is a continuation of the work we did in [the previous tutorial](#).

You can find [the results of the previous tutorial](#) and [the results of this tutorial](#) in [the book's GitHub repository](#).

Note that if you are importing the previous code to begin work here, you will also need the [copy of ActionBarSherlock in this book's GitHub repository](#), and to make sure that your imported EmPubLite project references the ActionBarSherlock project as a library.

Starting in this tutorial, we will now begin editing Java source files. Eclipse users should try to remember two useful shortcut key combinations:

- <Ctrl>-<Shift>-<O> will organize your Java import statements, including finding imports for any classes or interfaces you have referenced in your code but have not yet imported
- <Ctrl>-<Shift>-<F> will reformat the Java or XML in the current editing window, in accordance with either the default styles in Eclipse or whatever you have modified them to via the Preferences window.

## Step #1: Setting the Theme and Splitting the Bar

In order to use ActionBarSherlock, we need to apply a theme to our activities. As [discussed previously](#), a theme applies a certain look and feel to the activities, such as color scheme. We need to use a theme from ActionBarSherlock itself for our action

## TUTORIAL #7 - ADDING THE ACTION BAR

---

bar to work. And, since we need the theme for all of our activities, we will set up the theme application-wide.

Also, over time, we may add enough items to our action bar that, on phones in portrait mode, things get too crowded. To combat this threat, we will also tell Android to split our action bar on narrow screens, giving us space at the top and bottom of the screen for our items.

If you wish to make this change using Eclipse's wizards and tools, follow the instructions in the "Eclipse" section below. Otherwise, follow the instructions in the "Outside of Eclipse" section (appears after the "Eclipse" section).

### Eclipse

Back in `AndroidManifest.xml`, click over to the Application sub-tab of the editor. Click the "Browse..." button to the right of the Theme field, choose "Theme.Sherlock.Light.DarkActionBar" from the list, then click OK.

Also, click the "Select..." button next to the "Ui options" field, check the checkbox next to "splitActionBarWhenNarrow", and click "OK" to accept that change.

Your Application sub-tab's "Application Attributes" area should now resemble:

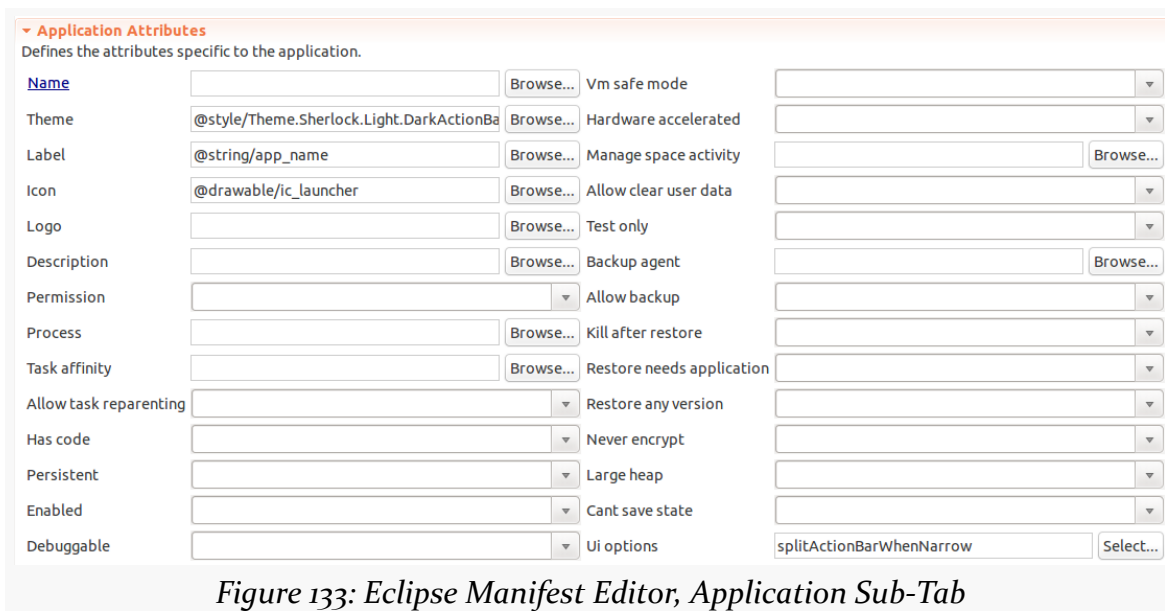


Figure 133: Eclipse Manifest Editor, Application Sub-Tab

You can now save your changes (e.g., `<Ctrl>-<S>`).

### Outside of Eclipse

Back in `AndroidManifest.xml`, add `android:theme="@style/Theme.Sherlock.Light.DarkActionBar"` and `android:uiOptions="splitActionBarWhenNarrow"` attributes to the `<application>` element, replacing any existing attributes with the same name. Your resulting manifest should resemble:

```
<?xml version="1.0" encoding="utf-8"?>
<manifest xmlns:android="http://schemas.android.com/apk/res/android"
    package="com.commonware.empublite"
    android:versionCode="1"
    android:versionName="1.0">

    <uses-sdk
        android:minSdkVersion="9"
        android:targetSdkVersion="15"/>

    <supports-screens
        android:largeScreens="true"
        android:normalScreens="true"
        android:smallScreens="false"
        android:xlargeScreens="true"/>

    <application
        android:allowBackup="true"
        android:icon="@drawable/ic_launcher"
        android:label="@string/app_name"
        android:theme="@style/Theme.Sherlock.Light.DarkActionBar"
        android:uiOptions="splitActionBarWhenNarrow">
        <activity
            android:name="EmPubLiteActivity"
            android:label="@string/app_name">
            <intent-filter>
                <action android:name="android.intent.action.MAIN"/>

                <category android:name="android.intent.category.LAUNCHER"/>
            </intent-filter>
        </activity>
    </application>
</manifest>
```

### Step #2: Changing to SherlockFragmentActivity

The final step to simply have an action bar is to have our activity inherit from a suitable `ActionBarSherlock` base class. Ordinarily, we might choose `SherlockActivity`. However, in a future tutorial, we will start working with



## TUTORIAL #7 - ADDING THE ACTION BAR

---

fragments, and so with that in mind, we will set up `EmPubLiteActivity` to inherit from `SherlockFragmentActivity`.

If you open up `EmPubLiteActivity`, you will see that our current implementation is untouched from what Android code-generated for us when we created our project:

```
package com.commonsware.empublite;

import android.os.Bundle;
import android.app.Activity;
import android.view.Menu;

public class EmPubLiteActivity extends Activity {

    @Override
    protected void onCreate(Bundle savedInstanceState) {
        super.onCreate(savedInstanceState);
        setContentView(R.layout.main);
    }

    @Override
    public boolean onCreateOptionsMenu(Menu menu) {
        // Inflate the menu; this adds items to the action bar
        // if it is present.
        getMenuInflater().inflate(R.menu.activity_main, menu);
        return true;
    }
}
```

Simply change it from `extends Activity` to `extends SherlockFragmentActivity`. You will need to adjust your imports to import `com.actionbarsherlock.app.SherlockFragmentActivity` (Eclipse users can simply press `<Ctrl>-<Shift>-<O>` to automatically fix up the imports). Also, delete the `onCreateOptionsMenu()` implementation that was code-generated for you.

The result should resemble:

```
package com.commonsware.empublite;

import android.os.Bundle;
import com.actionbarsherlock.app.SherlockFragmentActivity;

public class EmPubLiteActivity extends SherlockFragmentActivity {
    @Override
    public void onCreate(Bundle savedInstanceState) {
        super.onCreate(savedInstanceState);
        setContentView(R.layout.main);
    }
}
```

### Step #3: Defining Some Options

Of course, our current action bar is very boring.

Very, very boring.

To make it more useful and worthy of its screen space, we need to start adding some action items. Right now, we will add a couple of low-priority action items, for a help screen and an “about” screen.

If you wish to make this change using Eclipse’s wizards and tools, follow the instructions in the “Eclipse” section below. Otherwise, follow the instructions in the “Outside of Eclipse” section (appears after the “Eclipse” section).

#### Eclipse

Open the `res/menu/` folder in your project. Right-click over the `activity_main.xml` file (or the `main.xml` file, if there is no `activity_main.xml` file), choose Refactor > Rename from the context menu, and rename it to `options.xml`. Then, double-click on this file to open it in an Eclipse resource editor.

Click on the existing `menu_settings` menu item (code-generated for us) and change the following values:

- In “Id”, enter `@+id/help`
- Delete the `100` from “Order in category”
- In “Icon”, enter `@android:drawable/ic_menu_help`

Note that there is [an unpleasant bug](#), whereby copy-and-paste in structured editors like this one is broken, so you will have to type in the values by hand, or paste things in the XML directly.

Also, click the “Browse...” button to the right of the Title field. Click the “New String...” button towards the bottom of the dialog, to bring up the string resource editor:

## TUTORIAL #7 - ADDING THE ACTION BAR

---

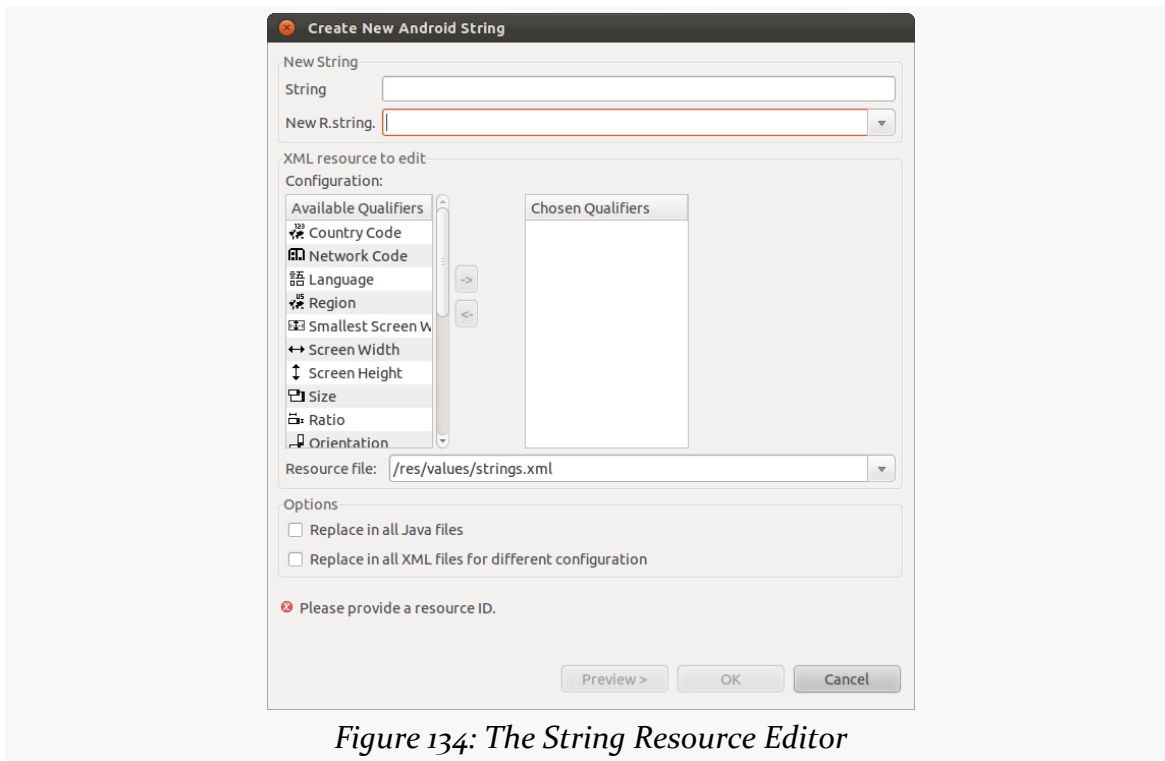


Figure 134: The String Resource Editor

Fill in `help` in the String field and `help` in the “New R.string.” field, then click “OK” to define this string resource. Choose the `help` string resource in the resource chooser, then click “OK” to use it. Save your file (e.g., `<Ctrl>-<S>`).

Next, we want to add a new menu item, so click the “Add...” button to the right of the list of menu options. Note that when you click the “Add...” button, you will initially be offered to create a child of the currently-selected item — click the “Create a new element at the top level, in Menu” radio button to be able to create a new item.

This time, use the following values:

- In “Id”, enter `@+id/about`
- In “Title”, create a new R.string.about string resource, with a value of `About`
- In “Icon”, enter `@android:drawable/ic_menu_info_details`
- In “Show as action”, click the “Select...” button and choose “never” from the list
- Save your changes (e.g., `<Ctrl>-<S>`)

### Outside of Eclipse

Delete the existing `res/menu/activity_main.xml` file (or the `main.xml` file, if there is no `activity_main.xml` file) and create a new `res/menu/options.xml` file, filling in the following XML content:

```
<menu xmlns:android="http://schemas.android.com/apk/res/android">
    <item
        android:id="@+id/help"
        android:icon="@android:drawable/ic_menu_help"
        android:showAsAction="never"
        android:title="@string/help" />
    <item
        android:id="@+id/about"
        android:icon="@android:drawable/ic_menu_info_details"
        android:showAsAction="never"
        android:title="@string/about">
    </item>
</menu>
```

Also, you will need to add string resources for help and about, by adding appropriate `<string>` elements to your existing `res/values/strings.xml` file:

```
<?xml version="1.0" encoding="utf-8"?>
<resources>
    <string name="app_name">EmPub Lite</string>
    <string name="menu_settings">Settings</string>
    <string name="help">Help</string>
    <string name="about">About</string>
</resources>
```

### Step #4: Loading and Responding to Our Options

Simply defining `res/menu/options.xml` is insufficient. We need to actually tell Android to use what we defined in that file, and we need to add code to respond to when the user taps on our items.

To do that, you will need to add a Sherlock-flavored version of `onCreateOptionsMenu()` and an `onOptionsItemSelected()` method to `EmPubLiteActivity`, as follows:

```
@Override
public boolean onCreateOptionsMenu(Menu menu) {
```

## TUTORIAL #7 - ADDING THE ACTION BAR

---

```
new MenuInflater(this).inflate(R.menu.options, menu);

return(super.onCreateOptionsMenu(menu));
}

@Override
public boolean onOptionsItemSelected(MenuItem item) {
    switch (item.getItemId()) {
        case android.R.id.home:
            return(true);

        case R.id.about:
            return(true);

        case R.id.help:
            return(true);
    }

    return(super.onOptionsItemSelected(item));
}
```

**NOTE:** Copying and pasting this code may or may not work, depending on what you are using to read the book. For the PDF, some PDF viewers (e.g., Adobe Reader) should copy the code fairly well; others may do a much worse job.

In `onCreateOptionsMenu()`, we are inflating `res/menu/options.xml` and pouring its contents into the supplied `Menu` object, which will be used by Android (and `ActionBarSherlock` on Android 2.x) to populate our action bar.

In `onOptionsItemSelected()`, we examine the supplied `MenuItem` and route to different branches of a `switch` statement based upon the item's ID. In addition to `R.id.about` and `R.id.help` — for the two items we defined in `res/menu/options.xml`, we also watch for `android.R.id.home`, which will be triggered by a tap on our icon, on the left side of the action bar.

To get this to compile, you will need to add some imports as well:

```
import com.actionbarsherlock.view.Menu;
import com.actionbarsherlock.view.MenuInflater;
import com.actionbarsherlock.view.MenuItem;
```

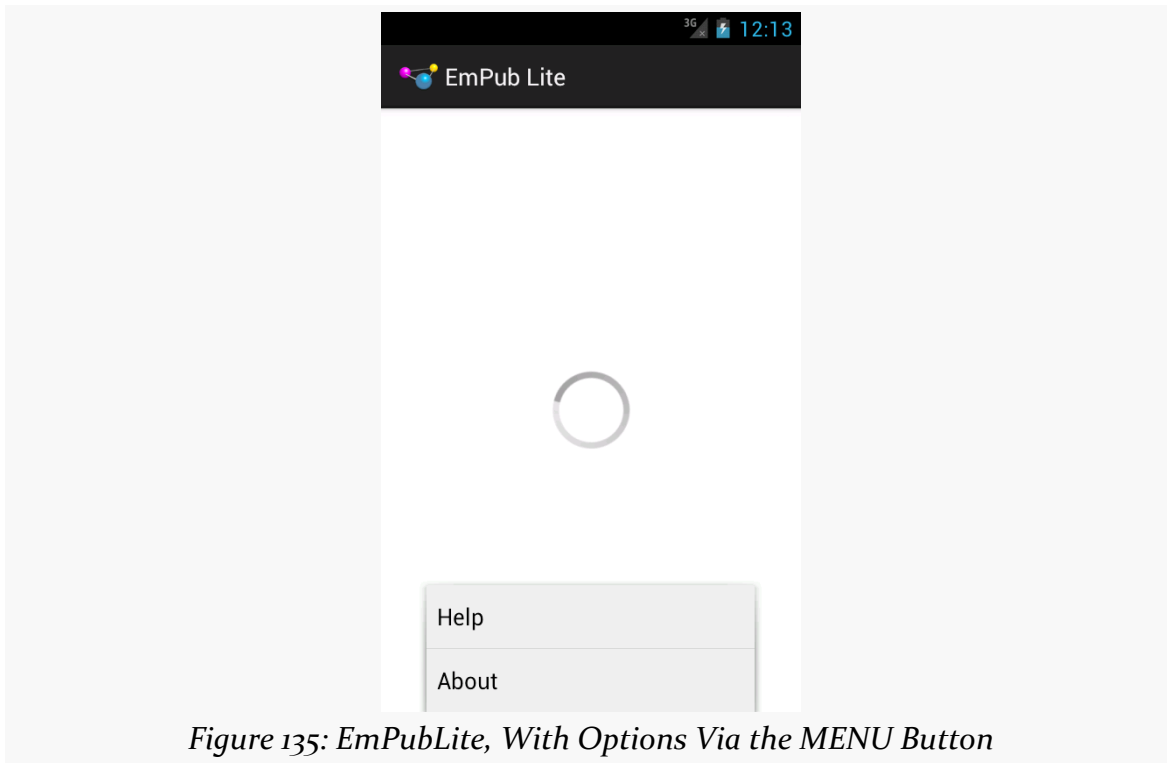
(Eclipse users can just use `<Ctrl>-<Shift>-<O>` to import these, choosing the “Sherlock” versions of the classes when prompted)

Also, the pasted code may be poorly formatted. Eclipse users can press `<Ctrl>-<Shift>-<F>` to format the code into something reasonable.

## TUTORIAL #7 - ADDING THE ACTION BAR

---

If you run this in a device or emulator, you may see no initial difference. That would be for devices or emulators that have a MENU button. To display our options, you would need to press MENU:

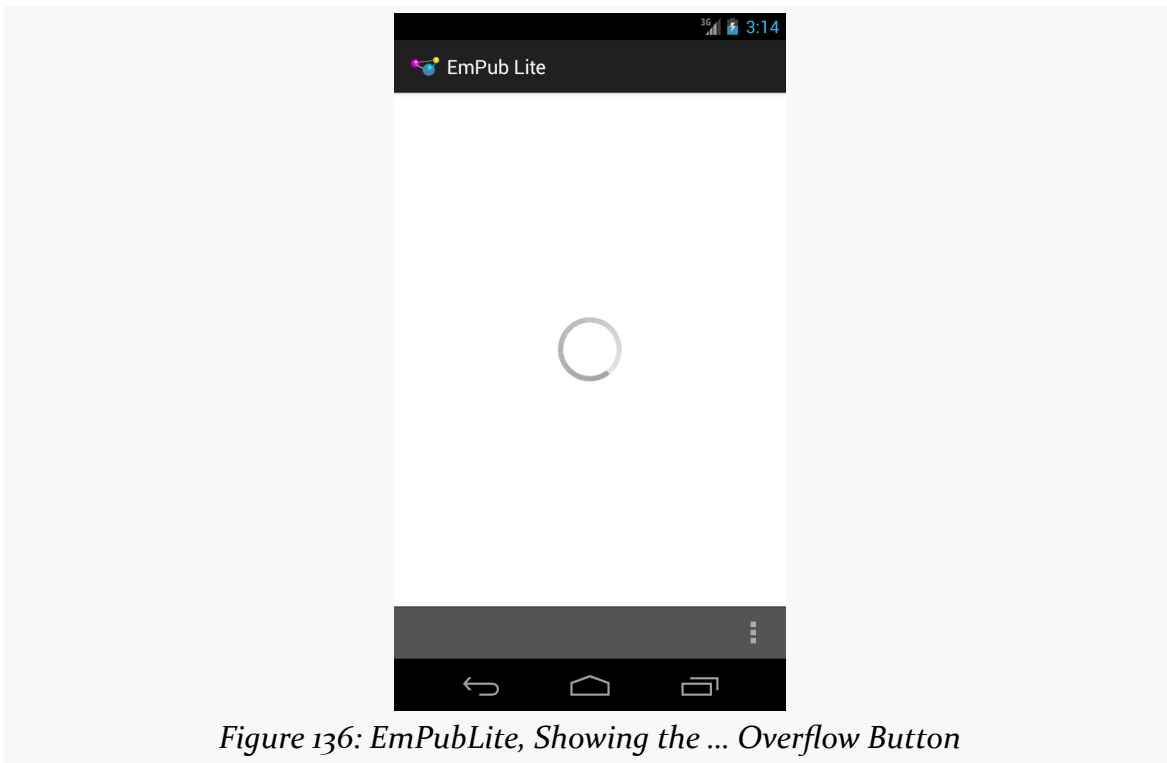


*Figure 135: EmPubLite, With Options Via the MENU Button*

On devices that lack a dedicated MENU button, the action bar will have a “...” icon somewhere on the split action bar:

## TUTORIAL #7 - ADDING THE ACTION BAR

---

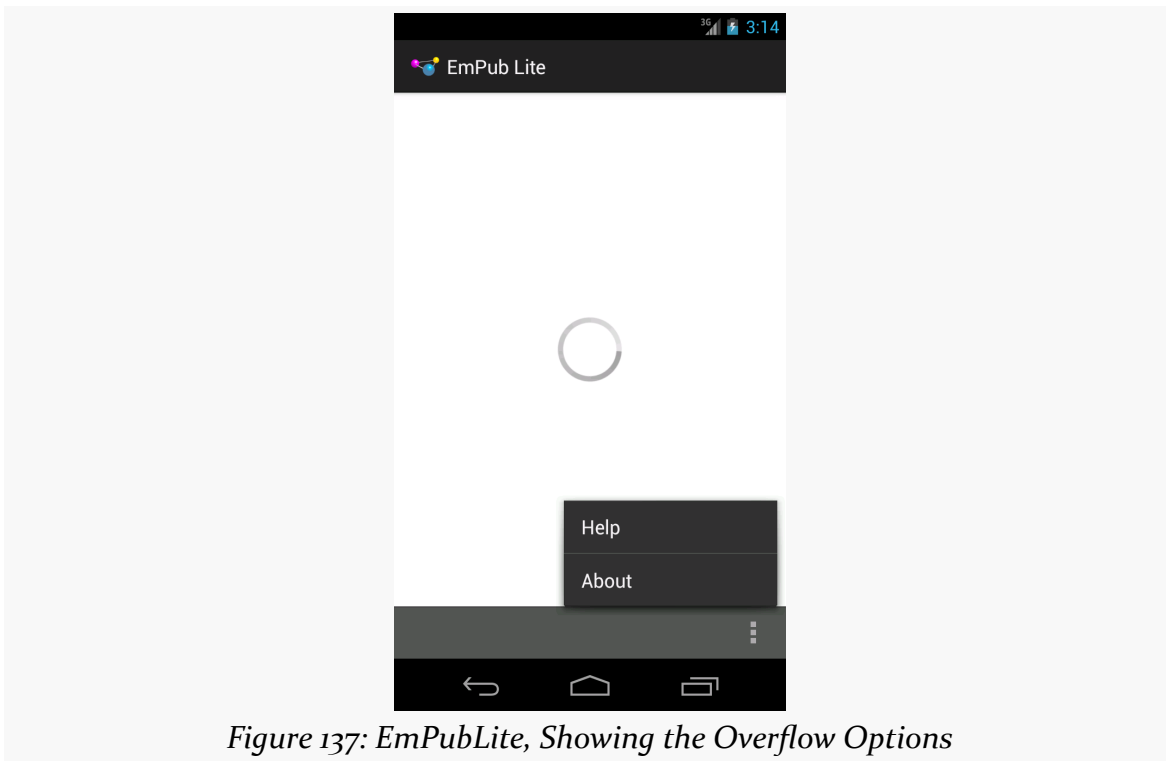


*Figure 136: EmPubLite, Showing the ... Overflow Button*

Pressing that brings up a menu showing our items:

## TUTORIAL #7 - ADDING THE ACTION BAR

---



*Figure 137: EmPubLite, Showing the Overflow Options*

### In Our Next Episode...

... we will [define our first new activity](#) on the tutorial project.





# Android's Process Model

---

So far, we have been treating our activity like it is our entire application. Soon, we will start to get into more complex scenarios, involving multiple activities and other types of components, like services and content providers.

But, before we get into a lot of that, it is useful to understand how all of this ties into the actual OS itself. Android is based on Linux, and Linux applications run in OS processes. Understanding a bit about how Android and Linux processes inter-relate will be useful in understanding how our mixed bag of components work within these processes.

## When Processes Are Created

A user installs your app, goes to their home screen's launcher, and taps on an icon representing your activity. Your activity dutifully appears on the screen.

Behind the scenes, what happened is that Android created a process. That process contains:

- A copy of the Dalvik VM, shared among all such processes via Linux copy-on-write memory sharing
- A copy of the Android framework classes, like Activity and Button, also shared via copy-on-write memory
- A copy of your own classes, loaded out of your APK
- Any objects created by you or the framework classes, such as the instance of your Activity subclass

## BACK, HOME, and Your Process

Suppose, with your activity in the foreground, the user presses BACK.

At this point, the user is telling the OS that she is done with your activity. Control will return to whatever preceded that activity — in this case, the home screen's launcher.

You might think that this would cause your process to be terminated. After all, that is how most desktop operating systems work. Once the user closes the last window of the application, the process hosting that application is terminated.

However, that is not how Android works. Android will *keep* your process around, for a little while at least. This is done for speed and power: if the user happens to want to return to your app sooner rather than later, it is more efficient to simply bring up another copy of your activity again in the existing process than it is to go set up a completely new copy of the process. This does not mean that your process will live forever; we will discuss when your process will go away later in this chapter.

Now, instead of the user pressing BACK, let's say that the user pressed HOME instead. Visually, there is little difference: the home screen re-appears. Depending on the home screen implementation there may be a visible difference, as BACK might return to a launcher whereas HOME might return to something else on the home screen. However, in general, they feel like very similar operations.

The difference is what happens to your activity.

When the user presses BACK, your foreground activity is *destroyed*. We will get into more of what that means [in the next chapter](#). However, the key feature is that the activity itself — the instance of your subclass of Activity — will never be used again, and hopefully is garbage collected.

When the user presses HOME, your foreground activity is *not* destroyed. It remains in memory. If the user launches your app again from the home screen launcher, and if your process is still around, Android will simply bring your existing activity instance back to the foreground, rather than having to create a brand-new one (as is the case if the user pressed BACK and destroyed your activity).

What HOME literally is doing is bringing the home screen activity back to the foreground, not otherwise directly affecting your process much.

### Termination

Processes cannot live forever. They take up a chunk of RAM, for your classes and objects, and these mobile devices only have so much RAM to work with. Eventually, therefore, Android has to get rid of your process, to free up memory for other applications.

How long your process will stick around depends on a variety of factors, including:

- What else the device is doing, either in the foreground (user using apps) or in the background (e.g., automated checks for new email)
- How much memory the device has
- What is still running inside your process

Going back to the scenario from above, we have an application with a single activity, where the user can return to the home screen either by pressing BACK or by pressing HOME. You might think that this has no difference at all on when the process would be terminated, but that would be incorrect. Pressing HOME would keep the process around perhaps a bit longer than would pressing BACK.

Why?

When the user presses BACK, your one and only activity is destroyed. When the user presses HOME, your activity is not destroyed. Android will tend to keep processes around longer if they have not-destroyed components in them.

The key word there is “tend”. Android’s algorithms for determining when to get rid of what processes are baked into the OS and are, at best, lightly documented. There is evidence to suggest that other criteria, such as process age, are also taken into account, and so there may be times when a process that has an activity running (but not in the foreground) might be terminated where a process with no running activity might not. However, in general, processes with active (not destroyed) components will stick around a bit longer than processes without such components.

### Foreground Means “I Love You”

Just because Android terminates processes to free up memory does not mean that it will terminate just any process to free up memory. A foreground process – the most common of which is a process that has an activity in the foreground – is the least likely of all to be terminated. In fact, you can pretty much assume that if Android

has to kill off the foreground process, that the phone is very sick and will crash in a matter of moments.

(and, fortunately, that does not happen very often)

So, if you are in the foreground, you are safe. It is only when you are not in the foreground that you are at risk of having the process be terminated.

## You and Your Heap

Processes take up RAM. A significant chunk of that RAM represents the objects you create (a.k.a., “the heap”).

Those of you with significant Java backgrounds know that the Java VM loves RAM (“can’t get enough of it!”). Java VMs routinely grab 64MB or 128MB of heap space upon creating the process and will grow as big as you wish to let them (e.g., `-Xmx` switch to the `java` command).

Android heap sizes are not that big, because Android is designed to run on mobile devices with constrained amounts of RAM.

Your heap limit may be as low as 16MB, though values in the 32–48MB range are more typical with current-generation devices. How much the heap limit will be depends a bit on what version of Android is on the device. It depends quite a lot, though, on the screen size, as bigger screens will tend to want to display bigger bitmap images, and bitmap images can consume quite a bit of RAM.

The key is that the heap is small, and (generally speaking) you cannot adjust it yourself. It is what it is. Small applications will rarely run into a problem with heap space, but larger applications might. We will discuss tools and techniques for measuring and coping with memory problems later in this book.

# Activities and Their Lifecycles

---

An Android application will have multiple discrete UI facets. For example, a calendar application needs to allow the user to view the calendar, view details of a single event, edit an event (including adding a new one), and so forth. And on smaller-screen devices, like most phones, you may not have room to squeeze all of this on the screen at once.

To handle this, you can have multiple activities. Your calendar application may have one activity to display the calendar, another to add or edit an event, one to provide settings for how the calendar should work, another for your online help, etc.

This, of course, implies that one of your activities has the means to start up another activity. For example, if somebody clicks on an event from the view-calendar activity, you might want to show the view-event activity for that event. This means that, somehow, you need to be able to cause the view-event activity to launch and show a specific event (the one the user clicked upon).

This can be further broken down into two scenarios:

- You know what activity you want to launch, probably because it is another activity in your own application
- You have a reference to... something (e.g., a Web page), and you want your users to be able to do... something with it (e.g., view it), but you do not know up front what the options are

This chapter will cover both of those scenarios.

In addition, frequently it will be important for you to understand when activities are coming and going from the foreground, so you can automatically save or refresh

data, etc. This is the so-called “activity lifecycle”, and we will examine it in detail as well in this chapter.

## Creating Your Second (and Third and...) Activity

Unfortunately, activities do not create themselves. On the positive side, this does help keep Android developers gainfully employed.

Hence, given a project with one activity, if you want a second activity, you will need to add it yourself. The same holds true for the third activity, the fourth activity, and so on.

The sample we will examine in this section is [Activities/Explicit](#). Our first activity, `ExplicitIntentsDemoActivity`, started off as just the default activity code generated by the build tools. Now, though, its layout contains a `Button`:

```
<?xml version="1.0" encoding="utf-8"?>
<LinearLayout xmlns:android="http://schemas.android.com/apk/res/android"
    android:layout_width="fill_parent"
    android:layout_height="fill_parent"
    android:orientation="vertical">

    <Button
        android:layout_width="fill_parent"
        android:layout_height="fill_parent"
        android:textSize="20sp"
        android:text="@string/hello"
        android:onClick="showOther"/>

</LinearLayout>
```

That `Button` is tied to a `showOther()` method in our activity implementation, which we will examine shortly.

## Defining the Class and Resources

To create your second (or third or whatever) activity, you first need to create the Java class. Outside of Eclipse, you can just create a new Java source file, containing a public Java class that extends `Activity` directly or indirectly.

From Eclipse, you also have the option of using the new-class dialog, which you get by right-clicking over the Java package you want to contain this activity and choosing `New > Class` from the context menu:

## ACTIVITIES AND THEIR LIFECYCLES

---

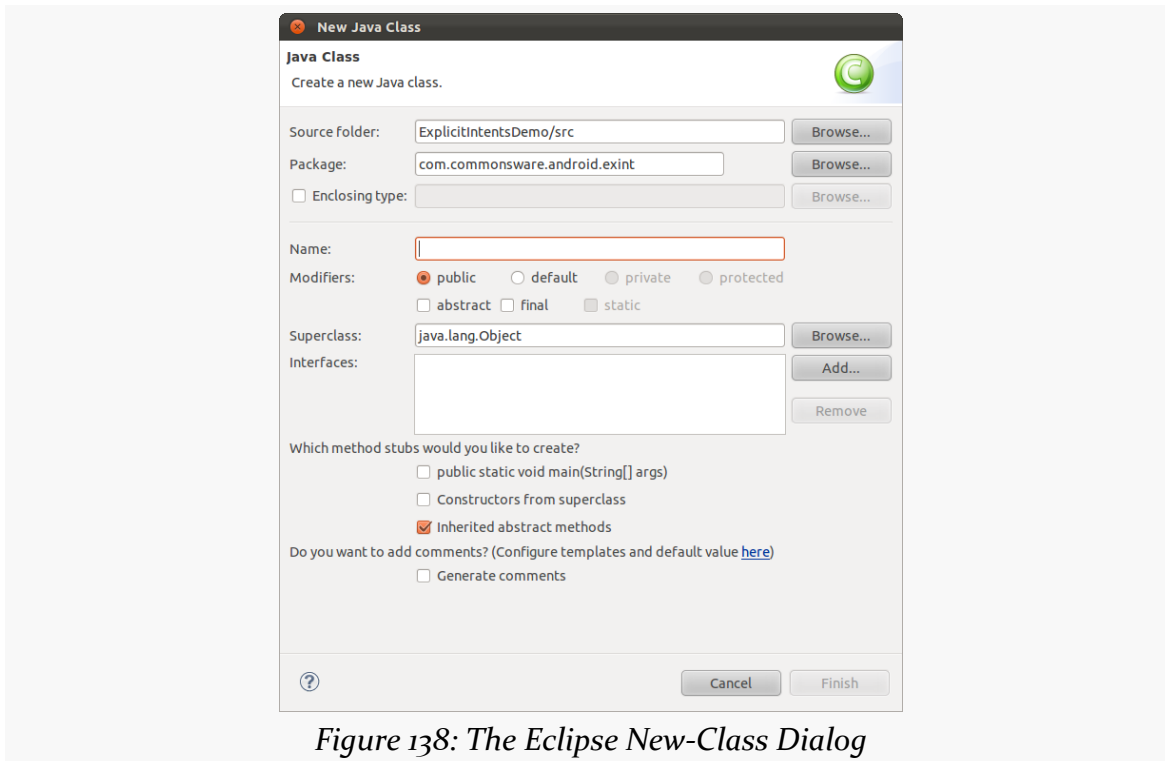


Figure 138: The Eclipse New-Class Dialog

Supply your class name (e.g., `OtherActivity`) and indicate its superclass (e.g., `com.actionbarsherlock.app.SherlockActivity`), then click “Finish” to add the empty class.

You can then add an `onCreate()` method to the activity, filling in all the details (e.g., `setContentView()`), just like you did with your first activity. Your new activity may need a new layout XML resource or other resources, which you would also have to create.

In `Activities/Explicit`, our second activity is `OtherActivity`, with pretty much the standard bare-bones implementation:

```
package com.commonsware.android.exint;

import android.app.Activity;
import android.os.Bundle;

public class OtherActivity extends Activity {
    @Override
    public void onCreate(Bundle savedInstanceState) {
        super.onCreate(savedInstanceState);
        setContentView(R.layout.other);
    }
}
```



```
}  
}
```

and a similarly simple layout, `res/layout/other.xml`:

```
<?xml version="1.0" encoding="utf-8"?>  
<LinearLayout xmlns:android="http://schemas.android.com/apk/res/android"  
    android:layout_width="fill_parent"  
    android:layout_height="fill_parent"  
    android:orientation="vertical">  
  
    <TextView  
        android:layout_width="fill_parent"  
        android:layout_height="wrap_content"  
        android:text="@string/other"  
        android:textColor="#FFFF0000"  
        android:textSize="20sp"/>  
  
</LinearLayout>
```

## Augmenting the Manifest

Simply having an activity implementation is not enough. We also need to add it to our `AndroidManifest.xml` file.

If you are using Eclipse, and you bring up the manifest in the editor, you can switch over to the Application sub-tab and look at the bottom half of the screen at the “Application Nodes” area:

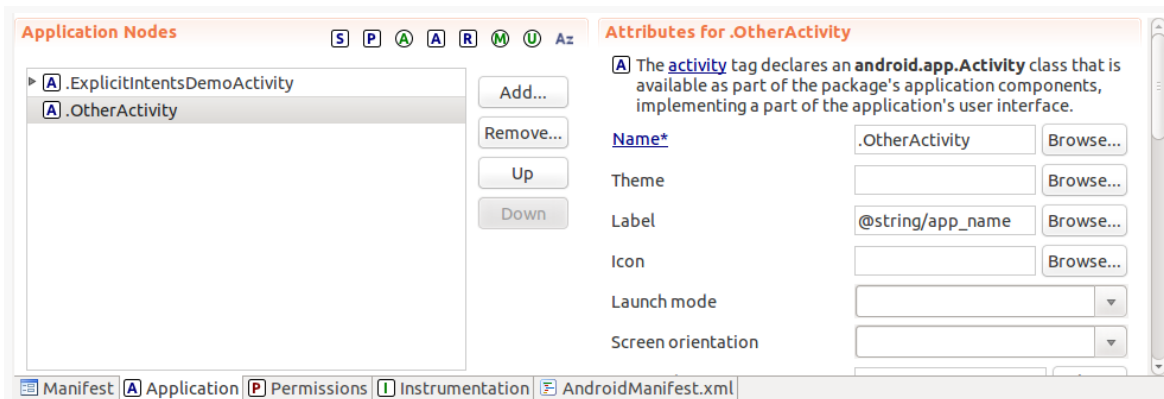
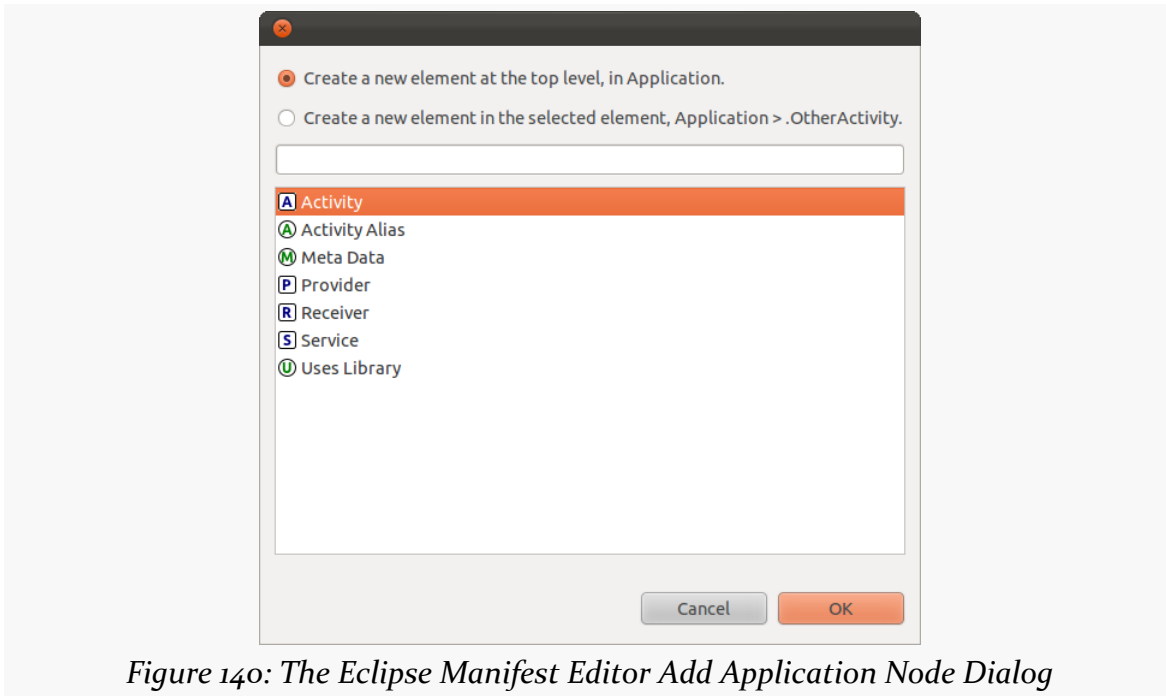


Figure 139: The Eclipse Manifest Editor Application Nodes

Clicking the “Add...” button will allow you to choose to add “a new element at the top level, in Application” and add an activity:

## ACTIVITIES AND THEIR LIFECYCLES

---



*Figure 140: The Eclipse Manifest Editor Add Application Node Dialog*

Clicking “OK” will give you a blank entry in the “Application Nodes” list, and you can fill in the details on the right. The only one that is essential is the “Name”, which will be the name of your activity — you can pick it out of a list via the “Browse...” button to the right of the “Name” field.

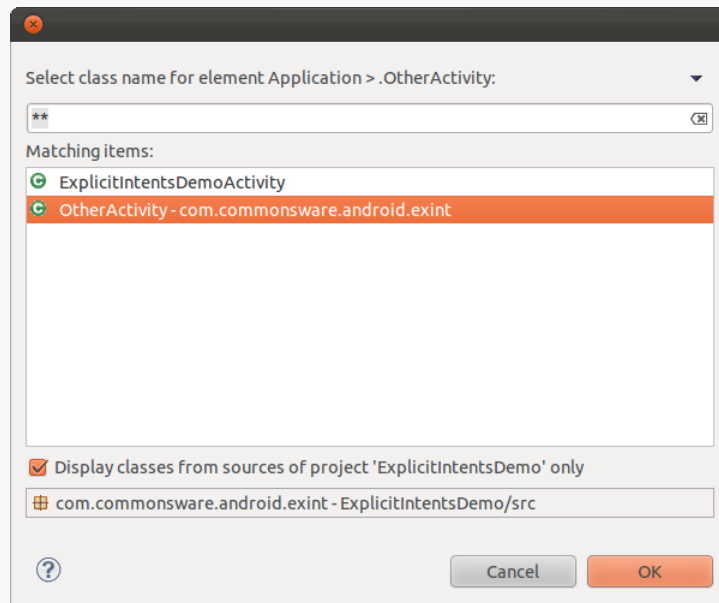


Figure 141: The Eclipse Manifest Editor Choose Activity Class Dialog

You can also elect to supply a “Label”, pointing to a string resource which will populate the gray title bar of your activity. By default, you will inherit the label from the `<application>` element.

Outside of Eclipse, adding an activity to the manifest is a matter of adding another `<activity>` element to the `<application>` element:

```
<?xml version="1.0" encoding="utf-8"?>
<manifest xmlns:android="http://schemas.android.com/apk/res/android"
    package="com.commonware.android.exint"
    android:versionCode="1"
    android:versionName="1.0">

    <uses-sdk
        android:minSdkVersion="7"
        android:targetSdkVersion="11"/>

    <supports-screens
        android:largeScreens="true"
        android:normalScreens="true"
        android:smallScreens="true"/>

    <application
        android:icon="@drawable/ic_launcher"
        android:label="@string/app_name">
        <activity
            android:name="ExplicitIntentsDemoActivity"
            android:label="@string/app_name">
```

```
<intent-filter>
  <action android:name="android.intent.action.MAIN" />

  <category android:name="android.intent.category.LAUNCHER" />
</intent-filter>
</activity>
<activity android:name="OtherActivity" />
</application>

</manifest>
```

You need the `android:name` attribute at minimum. Note that we do not include an `<intent-filter>` child element, the way the original activity has. For now, take it on faith that the original activity's `<intent-filter>` is what causes it to appear as a launchable activity in the home screen's launcher. We will get into more details of how that `<intent-filter>` works and when you might want your own [in a later chapter](#).

## Warning! Contains Explicit Intents!

An Intent encapsulates a request, made to Android, for some activity or other receiver to do something.

If the activity you intend to launch is one of your own, you may find it simplest to create an explicit Intent, naming the component you wish to launch. For example, from within your activity, you could create an Intent like this:

```
new Intent(this, HelpActivity.class);
```

This would stipulate that you wanted to launch the `HelpActivity`. This activity would need to be named in your `AndroidManifest.xml` file.

In `Activities/Explicit`, `ExplicitIntentsDemoActivity` has a `showOther()` method tied to its Button widget's `onClick` attribute. That method will use `startActivity()` with an explicit Intent, identifying `OtherActivity`:

```
package com.commonware.android.exint;

import android.app.Activity;
import android.content.Intent;
import android.os.Bundle;
import android.view.View;

public class ExplicitIntentsDemoActivity extends Activity {
    @Override
    public void onCreate(Bundle savedInstanceState) {
```

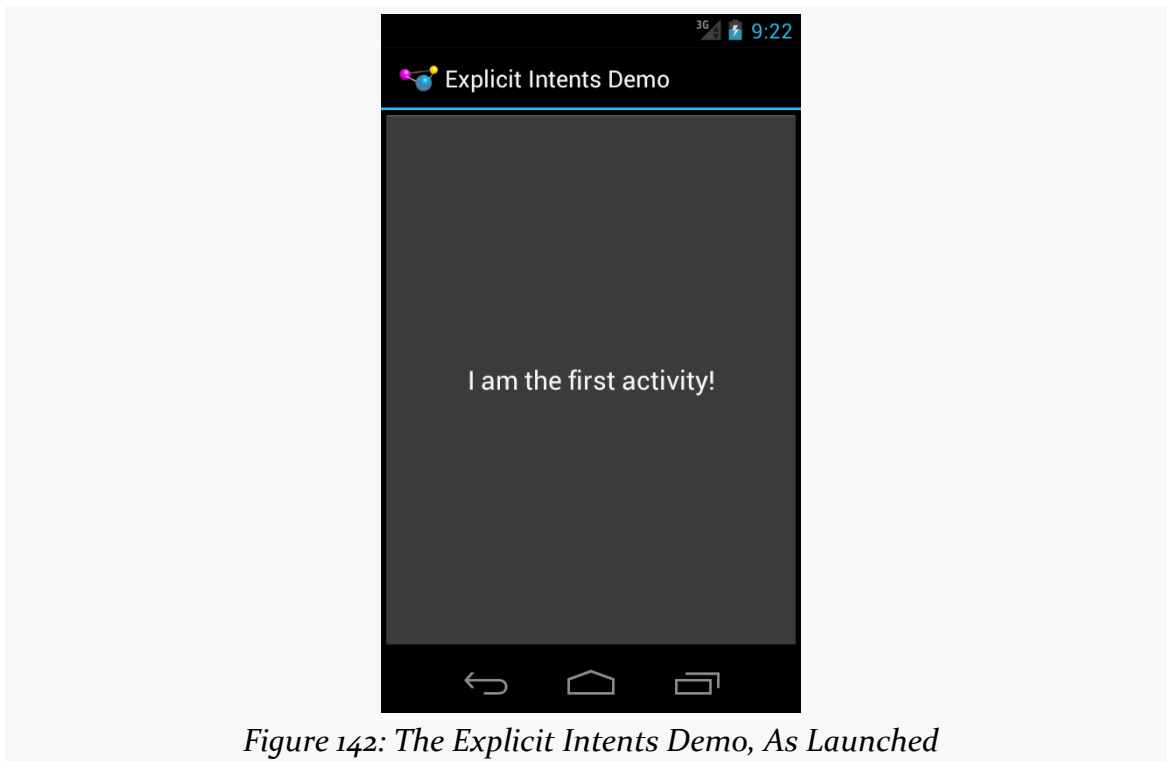
## ACTIVITIES AND THEIR LIFECYCLES

---

```
super.onCreate(savedInstanceState);
setContentView(R.layout.main);
}

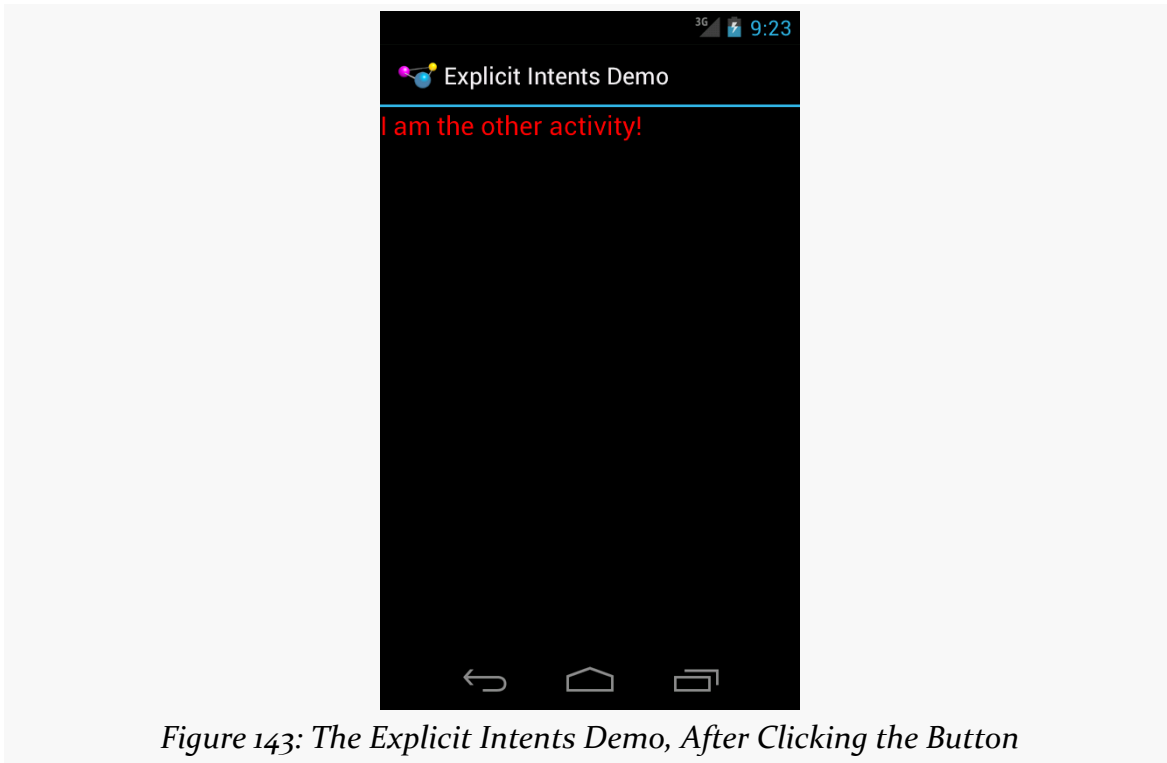
public void showOther(View v) {
    startActivity(new Intent(this, OtherActivity.class));
}
}
```

Our launched activity shows the button:



*Figure 142: The Explicit Intents Demo, As Launched*

Clicking the button brings up the other activity:



*Figure 143: The Explicit Intents Demo, After Clicking the Button*

Clicking BACK would return us to the first activity. In this respect, the BACK button in Android works much like the BACK button in your Web browser.

## Using Implicit Intents

The explicit Intent approach works fine when the activity to be started is one of yours.

However, you can also start up activities from the operating system or third-party apps. In those cases, though, you will not have a Java Class object representing the other activity in your project, so you cannot use the Intent constructor that takes a Class.

Instead, you will use what are referred as the “implicit” Intent structure, which looks an *awful* lot like how the Web works.

If you have done any work on Web apps, you are aware that HTTP is based on verbs applied to URIs:

- We want to GET this image
- We want to POST to this script or controller
- We want to PUT to this REST resource
- Etc.

Android's implicit Intent model works much the same way, just with a *lot* more verbs.

For example, suppose you get a latitude and longitude from somewhere (e.g., body of a tweet, body of a text message). You decide that you want to display a map on those coordinates. There are ways that you can embed a Google Map directly in your app — and we will see how [in a later chapter](#) — but that is complicated and assumes the user wants Google Maps. It would be better if we could create some sort of generic “hey, Android, display an activity that shows a map for this location” request.

As it turns out, we can, as is illustrated in the [Activities/Launch](#) sample project.

We have a LaunchDemo activity that uses a layout containing two EditText widgets and a Button, among other things:

```
<?xml version="1.0" encoding="utf-8"?>
<LinearLayout xmlns:android="http://schemas.android.com/apk/res/android"
    android:layout_width="fill_parent"
    android:layout_height="fill_parent"
    android:orientation="vertical">

    <LinearLayout
        android:layout_width="fill_parent"
        android:layout_height="wrap_content"
        android:orientation="horizontal">

        <TextView
            android:layout_width="wrap_content"
            android:layout_height="wrap_content"
            android:paddingLeft="2dip"
            android:paddingRight="4dip"
            android:text="@string/location"/>

        <EditText
            android:id="@+id/lat"
            android:layout_width="0dip"
            android:layout_height="wrap_content"
            android:layout_weight="1"
            android:inputType="numberDecimal|numberSigned"
            android:hint="@string/lat"/>

        <EditText
            android:id="@+id/lon"
```

## ACTIVITIES AND THEIR LIFECYCLES

---

```
        android:layout_width="0dip"
        android:layout_height="wrap_content"
        android:layout_weight="1"
        android:inputType="numberDecimal|numberSigned"
        android:hint="@string/lon"/>
</LinearLayout>

<Button
    android:id="@+id/map"
    android:layout_width="fill_parent"
    android:layout_height="wrap_content"
    android:onClick="showMe"
    android:text="@string/show_me"/>
</LinearLayout>
```

The Button is tied to a `showMe()` method on the activity itself, where we want to bring up a map on the latitude and longitude entered into the EditText widgets:

```
package com.commonware.android.activities;

import android.app.Activity;
import android.content.Intent;
import android.net.Uri;
import android.os.Bundle;
import android.view.View;
import android.widget.EditText;

public class LaunchDemo extends Activity {
    private EditText lat;
    private EditText lon;

    @Override
    public void onCreate(Bundle icle) {
        super.onCreate(icle);
        setContentView(R.layout.main);

        lat=(EditText)findViewById(R.id.lat);
        lon=(EditText)findViewById(R.id.lon);
    }

    public void showMe(View v) {
        String _lat=lat.getText().toString();
        String _lon=lon.getText().toString();
        Uri uri=Uri.parse("geo:"+_lat+","+_lon);

        startActivity(new Intent(Intent.ACTION_VIEW, uri));
    }
}
```

Just as HTTP uses a verb and a URI, Android uses an action and a `Uri`. The standard `Uri` structure to express a location is one that uses the `geo:` scheme, followed by the

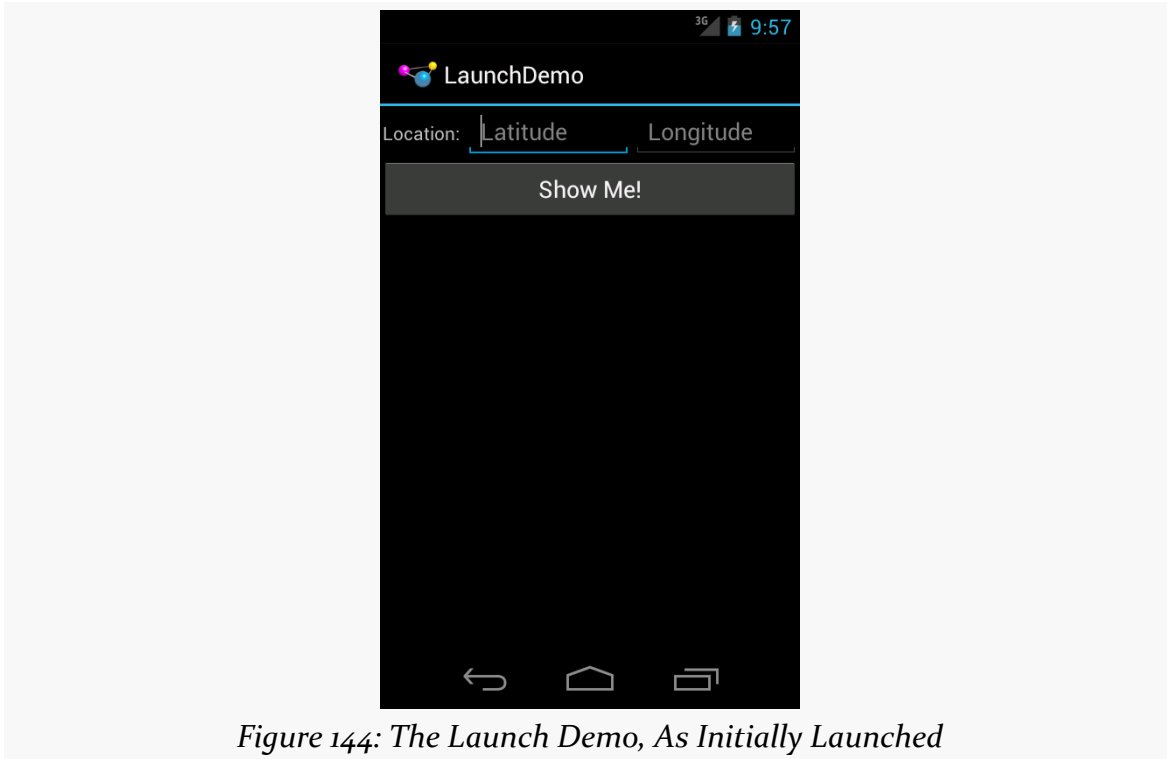


## ACTIVITIES AND THEIR LIFECYCLES

---

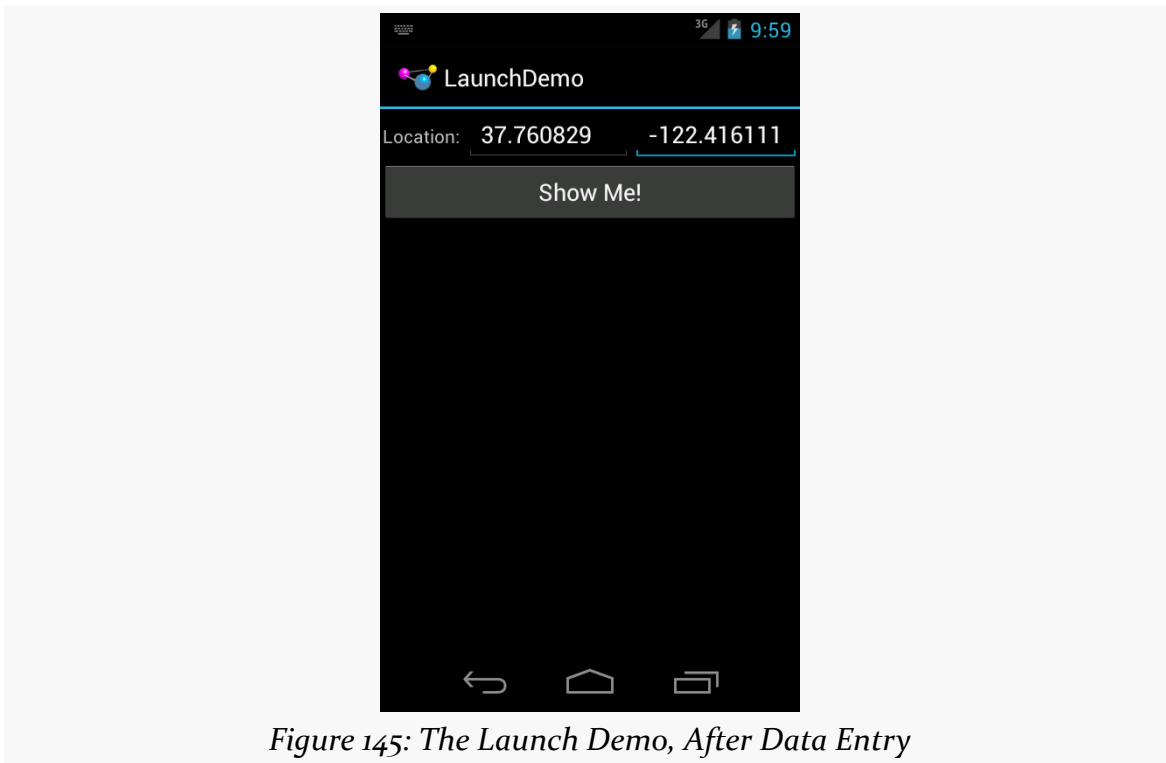
latitude and longitude in decimal degrees (e.g., `geo:37.760829,-122.416111`). Assembling this as a string is a matter of concatenation, but we then need to convert it to a `Uri` via calling `Uri.parse()`. Then, we can use an action called `ACTION_VIEW` to try to display a map on that location.

When launched, the user is presented with our data entry form:



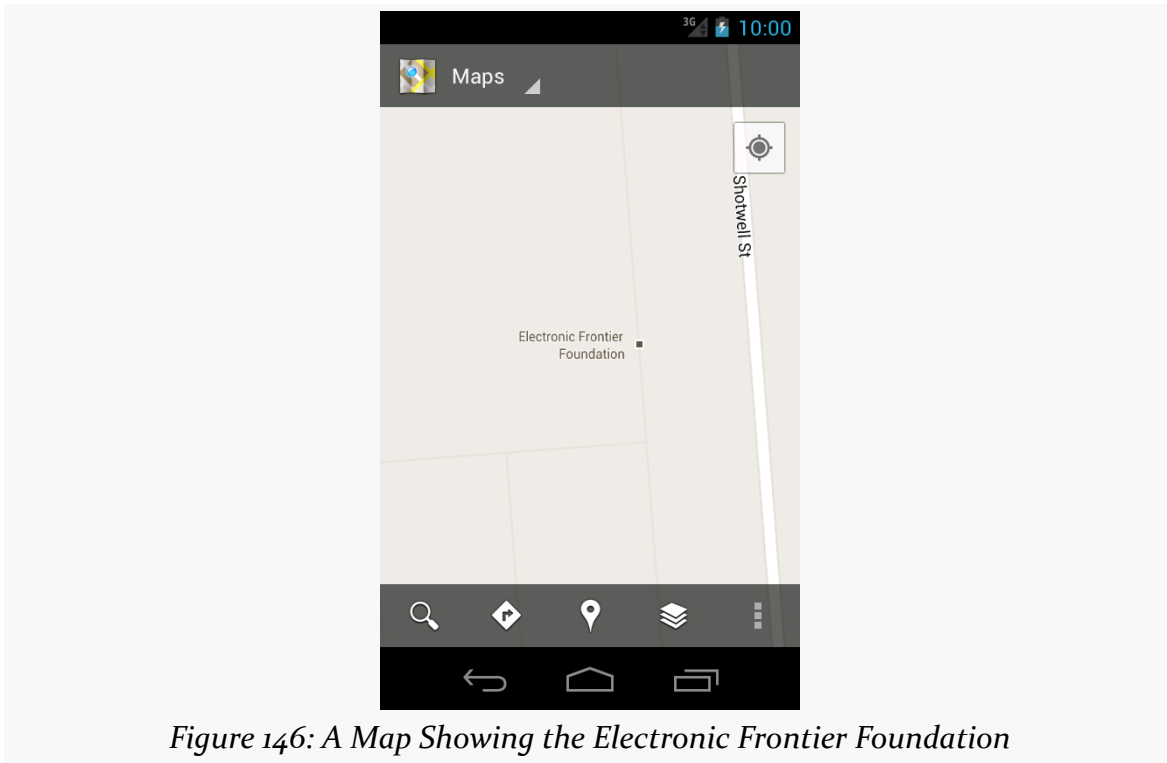
*Figure 144: The Launch Demo, As Initially Launched*

We can fill in a latitude and longitude, replacing the values displayed as the “hints” in the fields by the `android:hint` attribute:



*Figure 145: The Launch Demo, After Data Entry*

If the device has one application that responds to an ACTION\_VIEW Intent on a geo: scheme, clicking the “Show Me!” button will bring up a map on that location:



*Figure 146: A Map Showing the Electronic Frontier Foundation*

We will discuss what happens if there are no applications set up to handle this Intent, or if there is more than one, [in a later chapter](#).

## Extra! Extra!

Sometimes, we may wish to pass some data from one activity to the next. For example, we might have a `ListActivity` showing a collection of our model objects (e.g., books) and we have a separate `DetailActivity` to show information about a specific model object. Somehow, `DetailActivity` needs to know which model object to show.

One way to accomplish this is via Intent extras.

There is a series of `putExtra()` methods on `Intent` to allow you to supply key/value pairs of data to be bundled into the Intent. While you cannot pass arbitrary objects, most primitive data types are supported, as are strings and some types of lists.

## ACTIVITIES AND THEIR LIFECYCLES

---

Any activity can call `getIntent()` to retrieve the `Intent` used to start it up, and then can call various forms of `get...Extra()` (with the `...` indicating a data type) to retrieve any bundled extras.

For example, let's take a look at the [Activities/Extras](#) sample project.

This is mostly a clone of the `Activities/Explicit` sample from earlier in this chapter. However, this time, our first activity will pass an extra to the second:

```
package com.commonsware.android.extra;

import android.app.Activity;
import android.content.Intent;
import android.os.Bundle;
import android.view.View;

public class ExtrasDemoActivity extends Activity {
    @Override
    public void onCreate(Bundle savedInstanceState) {
        super.onCreate(savedInstanceState);
        setContentView(R.layout.main);
    }

    public void showOther(View v) {
        Intent other=new Intent(this, OtherActivity.class);

        other.putExtra(OtherActivity.EXTRA_MESSAGE, getString(R.string.other));
        startActivity(other);
    }
}
```

We create the `Intent` as before, but then call `putExtra()`, supplying a key (a static string named `OtherActivity.EXTRA_MESSAGE`) and a value (the `R.string.other` string resource). Then, and only then, do we call `startActivity()`.

Our revised `OtherActivity` then retrieves that extra, along with the inflated `TextView` (via `findViewById()`) and pours that text in:

```
package com.commonsware.android.extra;

import android.app.Activity;
import android.os.Bundle;
import android.widget.TextView;

public class OtherActivity extends Activity {
    public static final String EXTRA_MESSAGE="msg";

    @Override
    public void onCreate(Bundle savedInstanceState) {
```

```
super.onCreate(savedInstanceState);
setContentView(R.layout.other);

TextView tv=(TextView)findViewById(R.id.msg);

tv.setText(getIntent().getStringExtra(EXTRA_MESSAGE));
}
}
```

Visually, the result is the same. Functionally, the text to be shown is passed from one activity to the next.

## Asynchronicity and Results

Note that `startActivity()` is asynchronous. The other activity will not show up until sometime after you return control of the main application thread to Android.

Normally, this is not much of a problem. However, sometimes one activity might start another, where the first activity would like to know some “results” from the second. For example, the second activity might be some sort of “chooser”, to allow the user to pick a file or contact or song or something, and the first activity needs to know what the user chose. With `startActivity()` being asynchronous, it is clear that we are not going to get that sort of result as a return value from `startActivity()` itself.

To handle this scenario, there is a separate `startActivityForResult()` method. While it too is asynchronous, it allows the newly-started activity to supply a result (via a `setResult()` method) that is delivered to the original activity via an `onActivityResult()` method. We will examine `startActivityForResult()` in greater detail [in a later chapter](#).

## Schroedinger’s Activity

An activity, generally speaking, is in one of four states at any point in time:

1. *Active*: the activity was started by the user, is running, and is in the foreground. This is what you are used to thinking of in terms of your activity’s operation.
2. *Paused*: the activity was started by the user, is running, and is visible, but another activity is overlaying part of the screen. During this time, the user can see your activity but may not be able to interact with it. This is a

relatively uncommon state, as most activities are set to fill the screen, not have a theme that makes them look like some sort of dialog box.

3. *Stopped*: the activity was started by the user, is running, but it is hidden by other activities that have been launched or switched to.
4. *Dead*: the activity was destroyed, perhaps due to the user pressing the BACK button.

## Life, Death, and Your Activity

Android will call into your activity as the activity transitions between the four states listed above.

Note that for all of these, you should chain upward and invoke the superclass' edition of the method, or Android may raise an exception.

### `onCreate()` and `onDestroy()`

We have been implementing `onCreate()` in all of our Activity subclasses in all the examples. This will get called in two primary situations:

- When the activity is first started (e.g., since a system restart), `onCreate()` will be invoked with a `null` parameter.
- If the activity had been running and you have set up your activity to have different resources based on different device states (e.g., landscape versus portrait), your activity will be re-created and `onCreate()` will be called. We will discuss this scenario in greater detail later in this book.

Here is where you initialize your user interface and set up anything that needs to be done once, regardless of how the activity gets used.

On the other end of the lifecycle, `onDestroy()` may be called when the activity is shutting down, such as because the activity called `finish()` (which “finishes” the activity) or the user presses the BACK button. Hence, `onDestroy()` is mostly for cleanly releasing resources you obtained in `onCreate()` (if any), plus making sure that anything you started up outside of lifecycle methods gets stopped, such as background threads.

Bear in mind, though, that `onDestroy()` may not be called. This would occur in a few circumstances:

- You crash with an unhandled exception
- The user force-stops your application, such as through the Settings app
- Android has an urgent need to free up RAM (e.g., to handle an incoming phone call), wants to terminate your process, and cannot take the time to call all the lifecycle methods

Hence, `onDestroy()` is very likely to be called, but it is not guaranteed.

Also, bear in mind that it may take a long time for `onDestroy()` to be called. It is called quickly if the user presses BACK to finish the foreground activity. If, however, the user presses HOME to bring up the home screen, your activity is not immediately destroyed. `onDestroy()` will not be called until Android does decide to gracefully terminate your process, and that could be seconds, minutes, or hours later.

### `onStart()`, `onRestart()`, and `onStop()`

An activity can come to the foreground either because it is first being launched, or because it is being brought back to the foreground after having been hidden (e.g., by another activity, by an incoming phone call).

The `onStart()` method is called in either of those cases. The `onRestart()` method is called in the case where the activity had been stopped and is now restarting.

Conversely, `onStop()` is called when the activity is about to be stopped. It too may not be called, for the same reasons that `onDestroy()` would not be called. However, `onStop()` is usually called fairly quickly after the activity is no longer visible, so the odds that `onStop()` will be called are even higher than that of `onDestroy()`.

### `onPause()` and `onResume()`

The `onResume()` method is called just before your activity comes to the foreground, either after being initially launched, being restarted from a stopped state, or after a pop-up dialog (e.g., incoming call) is cleared. This is a great place to refresh the UI based on things that may have occurred since the user last was looking at your activity. For example, if you are polling a service for changes to some information (e.g., new entries for a feed), `onResume()` is a fine time to both refresh the current view and, if applicable, kick off a background thread to update the view (e.g., via a `Handler`).

Conversely, anything that steals your user away from your activity — mostly, the activation of another activity — will result in your `onPause()` being called. Here, you should undo anything you did in `onResume()`, such as stopping background threads, releasing any exclusive-access resources you may have acquired (e.g., camera), and the like.

Once `onPause()` is called, Android reserves the right to kill off your activity's process at any point. Hence, you should not be relying upon receiving any further events.

So, what is the difference between `onPause()` and `onStop()`? If an activity comes to the foreground that fills the screen, your current foreground activity will be called with `onPause()` and `onStop()`. If, however, an activity comes to the foreground that does *not* fill the screen, your current foreground activity will only be called with `onPause()`.

### Stick to the Pairs

If you initialize something in `onCreate()`, clean it up in `onDestroy()`.

If you initialize something in `onStart()`, clean it up in `onStop()`.

If you initialize something in `onResume()`, clean it up in `onPause()`.

In other words, stick to the pairs. For example, do not initialize something in `onStart()` and try to clean it up on `onPause()`, as there are scenarios where `onPause()` may be called multiple times in succession (i.e., user brings up a non-full-screen activity, which triggers `onPause()` but not `onStop()`, and hence not `onStart()`).

Which pairs of lifecycle methods you choose is up to you, depending upon your needs. You may decide that you need two pairs (e.g., `onCreate()/onDestroy()` and `onResume()/onPause()`). Just do not mix and match between them.

### When Activities Die

So, what gets rid of an activity? What can trigger the chain of events that results in `onDestroy()` being called?

First and foremost, when the user presses the BACK button, the foreground activity will be destroyed, and control will return to the previous activity in the user's



navigation flow (i.e., whatever activity they were on before the now-destroyed activity came to the foreground).

You can accomplish the same thing by calling `finish()` from your activity. This is mostly for cases where some other UI action would indicate that the user is done with the activity (e.g., the activity presents a list for the user to choose from — clicking on a list item might close the activity). However, please do not artificially add your own “exit”, “quit”, or other menu items or buttons to your activity — just allow the user to use normal Android navigation options, such as the BACK button.

If none of your activities are in the foreground any more, your application’s process is a candidate to be terminated to free up RAM. As noted earlier, depending on circumstances, Android may or may not call `onDestroy()` in these cases (`onPause()` and `onStop()` would have been called when your activities left the foreground).

If the user causes the device to go through a “configuration change”, such as switching between portrait and landscape, Android’s default behavior is to destroy your current foreground activity and create a brand new one in its place. We will cover this more in [a later chapter](#).

And, if your activity has an unhandled exception, your activity will be destroyed, though Android will not call any more lifecycle methods on it, as it assumes your activity is in an unstable state.

## Walking Through the Lifecycle

To see when these various lifecycle methods get called, let’s examine the [Activities/Lifecycle](#) sample project.

This project is the same as the `Activities/Extras` project, except that our two activities no longer inherit from `Activity` directly. Instead, we introduce a `LifecycleLoggingActivity` as a base class and have our activities inherit from it:

```
package com.commonware.android.lifecycle;

import android.app.Activity;
import android.os.Bundle;
import android.util.Log;

public class LifecycleLoggingActivity extends Activity {
    @Override
    public void onCreate(Bundle savedInstanceState) {
        super.onCreate(savedInstanceState);
    }
}
```

## ACTIVITIES AND THEIR LIFECYCLES

---

```
    Log.d(getClass().getSimpleName(), "onCreate()");
}

@Override
public void onRestart() {
    super.onRestart();

    Log.d(getClass().getSimpleName(), "onRestart()");
}

@Override
public void onStart() {
    super.onStart();

    Log.d(getClass().getSimpleName(), "onStart()");
}

@Override
public void onResume() {
    super.onResume();

    Log.d(getClass().getSimpleName(), "onResume()");
}

@Override
public void onPause() {
    Log.d(getClass().getSimpleName(), "onPause()");

    super.onPause();
}

@Override
public void onStop() {
    Log.d(getClass().getSimpleName(), "onStop()");

    super.onStop();
}

@Override
public void onDestroy() {
    Log.d(getClass().getSimpleName(), "onDestroy()");

    super.onDestroy();
}
}
```

All LifecycleLoggingActivity does is override each of the lifecycle methods mentioned above and emit a debug line to LogCat indicating who called what.

When we first launch the application, our first batch of lifecycle methods is invoked, in the expected order:

## ACTIVITIES AND THEIR LIFECYCLES

---

```
04-01 11:47:21.437: D/ExplicitIntentsDemoActivity(1473): onCreate()
04-01 11:47:21.827: D/ExplicitIntentsDemoActivity(1473): onStart()
04-01 11:47:21.827: D/ExplicitIntentsDemoActivity(1473): onResume()
```

If we click the button on the first activity to start up the second, we get:

```
04-01 11:47:54.776: D/ExplicitIntentsDemoActivity(1473): onPause()
04-01 11:47:54.877: D/OtherActivity(1473): onCreate()
04-01 11:47:54.947: D/OtherActivity(1473): onStart()
04-01 11:47:54.974: D/OtherActivity(1473): onResume()
04-01 11:47:55.347: D/ExplicitIntentsDemoActivity(1473): onStop()
```

Notice that our first activity is paused before the second activity starts up, and that `onStop()` is delayed on the first activity until after the second activity has appeared.

If we press the BACK button on the second activity, returning to the first activity, we see:

```
04-01 11:48:54.807: D/OtherActivity(1473): onPause()
04-01 11:48:54.857: D/ExplicitIntentsDemoActivity(1473): onRestart()
04-01 11:48:54.857: D/ExplicitIntentsDemoActivity(1473): onStart()
04-01 11:48:54.857: D/ExplicitIntentsDemoActivity(1473): onResume()
04-01 11:48:55.257: D/OtherActivity(1473): onStop()
04-01 11:48:55.257: D/OtherActivity(1473): onDestroy()
```

Notice how, once again, going onto the screen happens in between `onPause()` and `onStop()` of the activity leaving the screen. Also notice that `onDestroy()` is called immediately after `onStop()`, because the activity was finished via the BACK button.

If we now press the HOME button, to bring the home screen activity to the foreground, we see:

```
04-01 11:50:30.347: D/ExplicitIntentsDemoActivity(1473): onPause()
04-01 11:50:32.227: D/ExplicitIntentsDemoActivity(1473): onStop()
```

There is a delay between `onPause()` and `onStop()` as the home screen does its display work, and there is no `onDestroy()`, because the application is still running

and nothing finished the activity. Eventually, the device will terminate our process, and if that happens normally, we would see the `onDestroy()` LogCat message.

## Recycling Activities

Let us suppose that we have three activities, named A, B, and C. A starts up an instance of B based on some user input, and B later starts up an instance of C through some more user input.

Our “activity stack” is now A-B-C, meaning that if we press BACK from C, we return to B, and if we press BACK from B, we return to A.

Now, let’s suppose that from C, we wish to navigate back to A. For example, perhaps the user pressed the icon on the left of our action bar, and we want to return to the “home activity” as a result, and in our case that happens to be A. If C calls `startActivity()`, specifying A, we wind up with an activity stack that is A-B-C-A.

That’s because starting an activity, by default, creates a new instance of that activity. So, now we have two independent copies of A.

Sometimes, this is desired behavior. For example, we might have a single `ListActivity` that is being used to “drill down” through a hierarchical data set, like a directory tree. We might elect to keep starting instances of that same `ListActivity`, but with different extras, to show each level of that hierarchy. In this case, we would want independent instances of the activity, so the BACK button behaves as the user might expect.

However, when we navigate to the “home activity”, we may not want a separate instance of A.

How to address this depends a bit on what you want the activity stack to look like after navigating to A.

If you want an activity stack that is B-C-A — so the existing copy of A is brought to the foreground, but the instances of B and C are left alone — then you can add `FLAG_ACTIVITY_REORDER_TO_FRONT` to your Intent used with `startActivity()`:

```
Intent i=new Intent(this, HomeActivity.class);  
i.setFlags(Intent.FLAG_ACTIVITY_REORDER_TO_FRONT);  
startActivity(i);
```

## ACTIVITIES AND THEIR LIFECYCLES

---

If, instead, you want an activity stack that is just A — so if the user presses BACK, they exit your application — then you would add two flags:

FLAG\_ACTIVITY\_CLEAR\_TOP and FLAG\_ACTIVITY\_SINGLE\_TOP:

```
Intent i=new Intent(this, HomeActivity.class);  
i.setFlags(Intent.FLAG_ACTIVITY_CLEAR_TOP | Intent.FLAG_ACTIVITY_SINGLE_TOP);  
startActivity(i);
```

This will finish all activities in the stack between the current activity and the one you are starting — in our case, finishing C and B.

# **Tutorial #8 - Setting Up An Activity**

---

Of course, it would be nice if those “Help” and “About” menu choices that we added [in the previous tutorial](#) actually did something.

In this tutorial, we will define another activity class, one that will be responsible for displaying simple content like our help text and “about” details. And, we will arrange to start up that activity when those action bar items are selected. The activity will not actually display anything meaningful yet, as that will be the subject of the next few tutorials.

This is a continuation of the work we did in [the previous tutorial](#).

You can find [the results of the previous tutorial](#) and [the results of this tutorial](#) in [the book’s GitHub repository](#).

Note that if you are importing the previous code to begin work here, you will also need the [copy of ActionBarSherlock in this book’s GitHub repository](#), and to make sure that your imported EmPubLite project references the ActionBarSherlock project as a library.

## **Step #1: Creating the Stub Activity Class**

First, we need to define the Java class for our new activity, `SimpleContentActivity`.

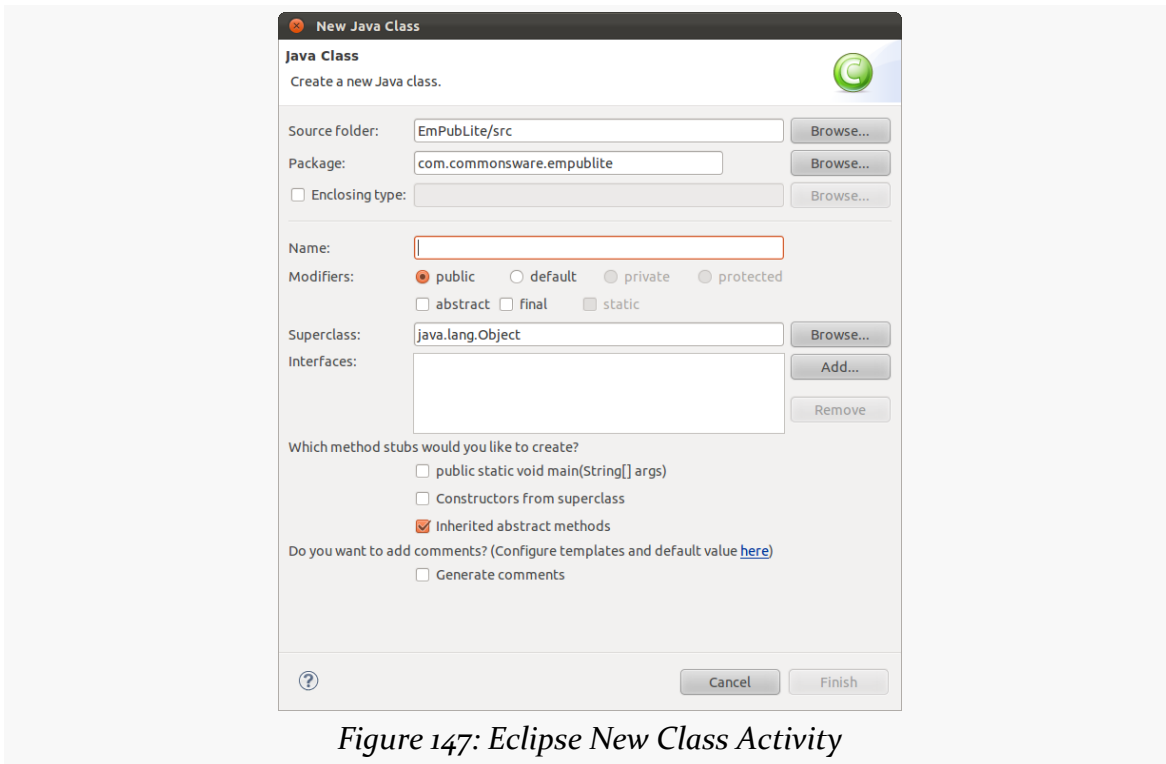
If you wish to make this change using Eclipse’s wizards and tools, follow the instructions in the “Eclipse” section below. Otherwise, follow the instructions in the “Outside of Eclipse” section (appears after the “Eclipse” section).

## TUTORIAL #8 - SETTING UP AN ACTIVITY

---

### Eclipse

Right click over the `com.commonware.empublite` package in the `src/` folder of your project, and choose `New > Class` from the context menu. That will bring up a dialog box for defining the new class:



*Figure 147: Eclipse New Class Activity*

Fill in `SimpleContentActivity` in the “Name” field. Then, click the “Browse...” button next to the “Superclass” field, and type in `Sherlock` in the field at the top of the resulting dialog:

## TUTORIAL #8 - SETTING UP AN ACTIVITY

---

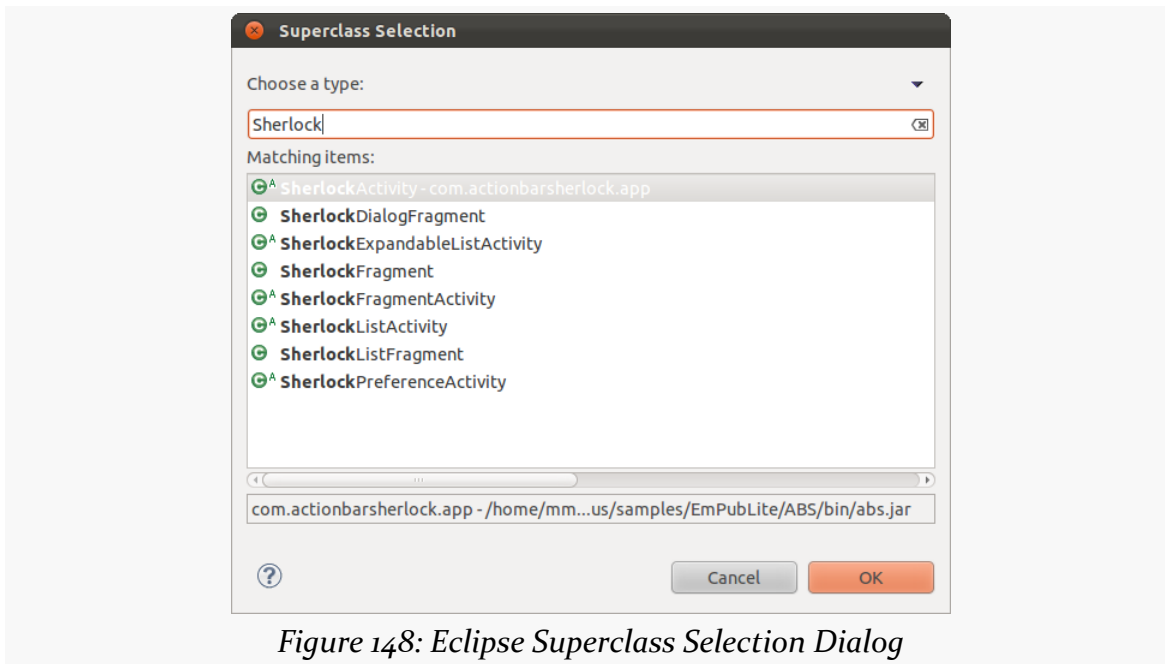


Figure 148: Eclipse Superclass Selection Dialog

Choose SherlockFragmentActivity from the list, and click “OK” to close up that dialog. Then, click “Finish” to close up the new-class dialog. This will create your new Java class, albeit with no methods. That is OK, as we do not need any methods at this time.

### Outside of Eclipse

Create a `src/com/commonsware/empublite/SimpleContentActivity.java` source file, with the following content:

```
package com.commonsware.empublite;

import com.actionbarsherlock.app.SherlockFragmentActivity;

public class SimpleContentActivity extends SherlockFragmentActivity {
}
```

### Step #2: Adding the Activity to the Manifest

If an activity was created in a forest and nobody was there to see it, does the activity really exist?



## TUTORIAL #8 - SETTING UP AN ACTIVITY

---

Or, to be a bit less oblique, simply creating the activity class is insufficient for it to be used. We also need to add an `<activity>` element to the manifest, so other parts of our code can start up the activity.

If you wish to make this change using Eclipse's wizards and tools, follow the instructions in the "Eclipse" section below. Otherwise, follow the instructions in the "Outside of Eclipse" section (appears after the "Eclipse" section).

### Eclipse

Double-click on `AndroidManifest.xml` in your project, and click over to the Application sub-tab. Scroll down to the "Application Nodes" list, then click the "Add..." button adjacent to that list. Choose "Activity" from the list of available items, and click "OK" to close up the dialog. This adds an empty activity entry in your manifest:

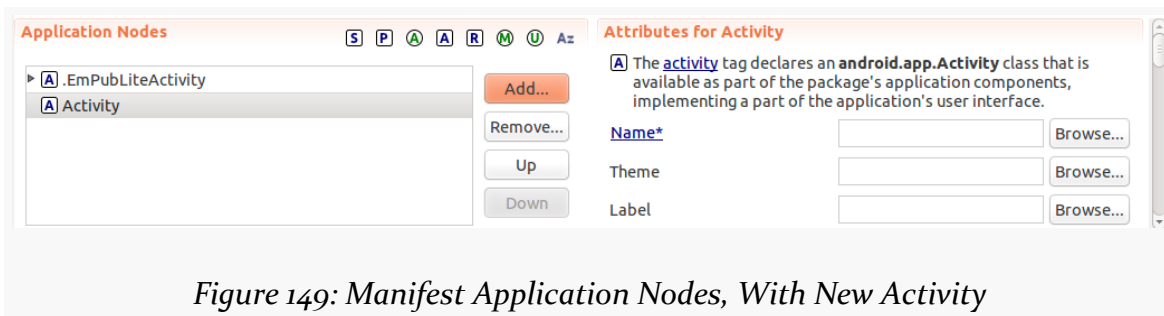


Figure 149: Manifest Application Nodes, With New Activity

Click the "Browse..." button to the right of the "Name" field. There will be a short pause while Eclipse scans your project for subclasses of Activity. In a moment, a list should appear, with `SimpleContentActivity` in it. Click on `SimpleContentActivity`, then click the "OK" button to make this choice. At this point, you can save your file (e.g., `<Ctrl>-<S>`).

### Outside of Eclipse

Open up the `AndroidManifest.xml` file in an editor and add an `<activity>` element, as a child of the `<application>` element, with an `android:name="SimpleContentActivity"` attribute, to the file. The result should resemble:

```
<?xml version="1.0" encoding="utf-8"?>
<manifest xmlns:android="http://schemas.android.com/apk/res/android"
    package="com.commonware.empublite"
```

## TUTORIAL #8 - SETTING UP AN ACTIVITY

---

```
android:versionCode="1"
android:versionName="1.0">

<uses-sdk
    android:minSdkVersion="9"
    android:targetSdkVersion="15"/>

<supports-screens
    android:largeScreens="true"
    android:normalScreens="true"
    android:smallScreens="false"
    android:xlargeScreens="true"/>

<application
    android:allowBackup="true"
    android:icon="@drawable/ic_launcher"
    android:label="@string/app_name"
    android:theme="@style/Theme.Sherlock.Light.DarkActionBar"
    android:uiOptions="splitActionBarWhenNarrow">
    <activity
        android:name="EmPubLiteActivity"
        android:label="@string/app_name">
        <intent-filter>
            <action android:name="android.intent.action.MAIN"/>

            <category android:name="android.intent.category.LAUNCHER"/>
        </intent-filter>
    </activity>
    <activity android:name="SimpleContentActivity">
    </activity>
</application>

</manifest>
```

### Step #3: Launching Our Activity

Now that we have declared that the activity exists and can be used, we can start using it.

Go into `EmPubLiteActivity` and modify `onOptionsItemSelected()` to add in some logic in the `R.id.about` and `R.id.help` branches, as shown below:

```
@Override
public boolean onOptionsItemSelected(MenuItem item) {
    switch (item.getItemId()) {
        case android.R.id.home:
            return(true);

        case R.id.about:
            Intent i=new Intent(this, SimpleContentActivity.class);
            startActivity(i);
```

## TUTORIAL #8 - SETTING UP AN ACTIVITY

---

```
        return(true);

    case R.id.help:
        i=new Intent(this, SimpleContentActivity.class);
        startActivity(i);

        return(true);
    }

    return(super.onOptionsItemSelected(item));
}
```

In those two branches, we create an Intent, pointing at our new SimpleContentActivity. Then, we call startActivity() on that Intent. Right now, both help and about do the same thing — we will add some smarts to have them load up different content later in this book.

You will need to add an import for android.content.Intent to get this to compile.

If you run this app in a device or emulator, and you choose either the Help or About menu choices, what appears to happen is that the ProgressBar vanishes. In reality, what happens is that our SimpleContentActivity appeared, but empty, as we have not given it a full UI yet.

### In Our Next Episode...

... we will [begin using fragments](#) in our tutorial project.

# The Tactics of Fragments

---

Fragments are an optional layer you can put between your activities and your widgets, designed to help you reconfigure your activities to support screens both large (e.g., tablets) and small (e.g., phones).

This chapter will cover basic uses of fragments, including supporting fragments on pre-Android 3.0 devices.

## The Six Questions

In the world of journalism, the basics of any news story consist of six questions, [the Five Ws and One H](#). Here, we will apply those six questions to help frame what we are talking about with respect to fragments.

### What?

Fragments are not activities, though they can be used by activities.

Fragments are not containers (i.e., subclasses of `ViewGroup`), though typically they create a `ViewGroup`.

Rather, you should think of fragments as being units of UI reuse. You define a fragment, much like you might define an activity, with layouts and lifecycle methods and so on. However, you can then host that fragment in one or several activities, as needed.

Functionally, fragments are Java classes, extending from a base `Fragment` class. As we will see, there are two versions of the `Fragment` class, one native to API Level 11 and one supplied by the Android Support package.

### Where??

Since fragments are Java classes, your fragments will reside in one of your application's Java packages. The simplest approach is to put them in the same Java package that you used for your project overall and where your activities reside, though you can refactor your UI logic into other packages if needed.

### Who?!?

Typically, you create fragment implementations yourself, then tell Android when to use them. Some third-party Android library projects may ship fragment implementations that you can reuse, if you so choose.

### When?!?!?

Some developers start adding fragments from close to the outset of application development — that is the approach we will take in the tutorials. And, if you are starting a new application from scratch, defining fragments early on is probably a good idea. That being said, it is entirely possible to “retrofit” an existing Android application to use fragments, though this may be a lot of work. And, it is entirely possible to create Android applications without fragments at all.

Fragments were introduced with Android 3.0 (API Level 11, a.k.a., Honeycomb).

### WHY?!?!?

Ah, this is the big question. If we have managed to make it this far through the book without fragments, and we do not necessarily need fragments to create Android applications, what is the point? Why would we bother?

The primary rationale for fragments was to make it easier to support multiple screen sizes.

Android started out supporting phones. Phones may vary in size, from tiny ones with less than 3” diagonal screen size (e.g., Sony Ericsson X10 mini), to monsters that are over 5” (e.g., Samsung Galaxy Note). However, those variations in screen size pale in comparison to the differences between phones and tablets, or phones and TVs.

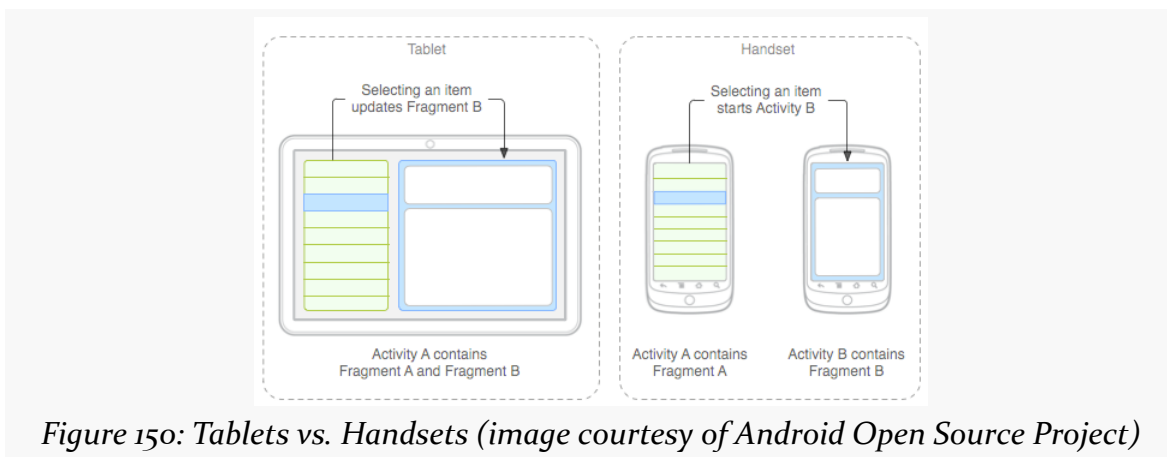
Some applications will simply expand to fill larger screen sizes. Many games will take this approach, simply providing the user with bigger interactive elements,

## THE TACTICS OF FRAGMENTS

---

bigger game boards, etc. The ever-popular Angry Birds game, for example, gives you bigger birds.

However, another design approach is to consider a tablet screen to really be a collection of phone screens, side by side.



*Figure 150: Tablets vs. Handsets (image courtesy of Android Open Source Project)*

The user can access all of that functionality at once on a tablet, whereas they would have to flip back and forth between separate screens on a phone.

For applications that can fit this design pattern, fragments allow you to support phones and tablets from one code base. The fragments can be used by individual activities on a phone, or they can be stitched together by a single activity for a tablet.

Details on using fragments to support large screen sizes is a topic for [a later chapter in this book](#). This chapter is focused on the basic mechanics of setting up and using fragments.

### OMGOMGOMG, HOW?!?!??

Well, answering that question is what the rest of this chapter is for, plus coverage of more advanced uses of fragments elsewhere in this book.

## Your First Fragment

In many ways, it is easier to explain fragments by looking at an implementation, more so than trying to discuss them as abstract concepts. So, in this section, we will

take a look at the [Fragments/Static](#) sample project. This is a near-clone of the [Activities/Lifecycle](#) sample project from [the previous chapter](#). However, we have converted the launcher activity from one that will host widgets directly itself to one that will host a fragment, which in turn manages widgets.

### The Project

We have two choices with fragments: use the native ones in API Level 11, or use a backport supplied by the Android Support package. So this sample can work on older versions of Android, we will use the Android Support package, adding it to the project.

We also add in ActionBarSherlock. That is not strictly required to use fragments, whether those are native API Level 11 fragments or are ones from the Android Support package. However, you may want to have an action bar in addition to fragments, in which case you would want to use ActionBarSherlock if you are using the backported fragments implementation. Also, using fragments with ActionBarSherlock requires some minor changes to your code, which this project will illustrate.

### The Fragment Layout

Our fragment is going to manage our UI, so we have a `res/layout/mainfrag.xml` layout file containing our Button:

```
<?xml version="1.0" encoding="utf-8"?>
<Button xmlns:android="http://schemas.android.com/apk/res/android"
    android:id="@+id/showOther"
    android:layout_width="fill_parent"
    android:layout_height="fill_parent"
    android:text="@string/hello"
    android:textSize="20sp"/>
```

Note, though, that we do not use the `android:onClick` attribute. We will explain why we dropped that attribute from the previous editions of this sample shortly.

### The Fragment Class

The project has a `ContentFragment` class that will use this layout and handle the Button. This class extends `SherlockFragment` — the Fragment implementation from ActionBarSherlock, which itself inherits from `android.support.v4.app.Fragment`

## THE TACTICS OF FRAGMENTS

---

from the Android Support package. If you wish to use the native API Level 11 fragments, you would inherit from `android.app.Fragment` instead.

As with activities, there is no constructor on a typical Fragment subclass. The primary method you override, though, is not `onCreate()` (though, as we will see later in this chapter, that is possible). Instead, the primary method to override is `onCreateView()`, which is responsible for returning the UI to be displayed for this fragment:

```
@Override
public View onCreateView(LayoutInflater inflater,
                        ViewGroup container,
                        Bundle savedInstanceState) {
    View result=inflater.inflate(R.layout.mainfrag, container, false);

    result.findViewById(R.id.showOther).setOnClickListener(this);

    return(result);
}
```

We are passed a `LayoutInflater` that we can use for inflating a layout file, the `ViewGroup` that will eventually hold anything we inflate, and the `Bundle` that was passed to the activity's `onCreate()` method. While we are used to framework classes loading our layout resources for us, we can “inflate” a layout resource at any time using a `LayoutInflater`. This process reads in the XML, parses it, walks the element tree, creates Java objects for each of the elements, and stitches the results together into a parent-child relationship.

Here, we inflate `res/layout/mainfrag.xml`, telling Android that its contents will eventually go into the `ViewGroup` but not to add it right away. While there are simpler flavors of the `inflate()` method on `LayoutInflater`, this one is required in case the `ViewGroup` happens to be a `RelativeLayout`, so we can process all of the positioning and sizing rules appropriately.

We also use `findViewById()` to find our `Button` widget and tell it that we, the fragment, are its `OnClickListener`. `ContentFragment` must then implement the `View.OnClickListener` interface to make this work. We do this instead of `android:onClick` to route the `Button` click events to the fragment, not the activity.

Since we implement the `View.OnClickListener` interface, we need the corresponding `onClick()` method implementation:

```
@Override
public void onClick(View v) {
```



```
((StaticFragmentsDemoActivity) getActivity()).showOther(v);
}
```

Any fragment can call `getActivity()` to find the activity that hosts it. In our case, the only activity that will possibly host this fragment is `StaticFragmentsDemoActivity`, so we can cast the result of `getActivity()` to `StaticFragmentsDemoActivity`, so that we can call methods on our activity. In particular, we are telling the activity to show the other activity, by means of calling the `showOther()` method that we saw in the original `Activities/Lifecycle` sample (and will see again shortly).

That is really all that is needed for this fragment. However, `ContentFragment` also overrides many other fragment lifecycle methods, and we will examine these [later in this chapter](#).

### The Activity Layout

Originally, the `res/layout/main.xml` used by the activity was where we had our `Button` widget. Now, the `Button` is handled by the fragment. Instead, our activity layout needs to account for the fragment itself.

In this sample, we are going to use a static fragment. Static fragments are easy to add to your application: just use the `<fragment>` element in a layout file, such as our revised `res/layout/main.xml`:

```
<?xml version="1.0" encoding="utf-8"?>
<fragment xmlns:android="http://schemas.android.com/apk/res/android"
    android:layout_width="fill_parent"
    android:layout_height="fill_parent"
    android:name="com.commonware.android.sfrag.ContentFragment"/>
```

Here, we are declaring our UI to be completely comprised of one fragment, whose implementation (`com.commonware.android.sfrag.ContentFragment`) is identified by the `android:name` attribute on the `<fragment>` element. Instead of `android:name`, you can use `class`, though most of the Android documentation has now switched over to `android:name`.

Eclipse users can drag a fragment out of the “Layouts” section of the graphical editor tool palette, if desired, rather than setting up the `<fragment>` element directly in the XML.

### The Activity Class

StaticFragmentsDemoActivity — our new launcher activity — looks identical to the previous version, with the exception of the class name:

```
package com.commonware.android.sfrag;

import android.content.Intent;
import android.os.Bundle;
import android.view.View;

public class StaticFragmentsDemoActivity extends
    LifecycleLoggingActivity {
    @Override
    public void onCreate(Bundle savedInstanceState) {
        super.onCreate(savedInstanceState);
        setContentView(R.layout.main);
    }

    public void showOther(View v) {
        Intent other=new Intent(this, OtherActivity.class);

        other.putExtra(OtherActivity.EXTRA_MESSAGE,
            getString(R.string.other));
        startActivity(other);
    }
}
```

However, there is one change hidden in the new LifecycleLoggingActivity. We no longer inherit from Activity, but instead inherit from SherlockFragmentActivity:

```
package com.commonware.android.sfrag;

import android.os.Bundle;
import android.util.Log;
import com.actionbarsherlock.app.SherlockFragmentActivity;

public class LifecycleLoggingActivity extends SherlockFragmentActivity {
```

There are three primary possible base classes for your fragment-powered activities:

1. If you are using native API Level 11 fragments and action bar, you can inherit from the ordinary Activity class as you normally would
2. If you are using the Android Support package for your fragments but are not using ActionBarSherlock (e.g., you are skipping an action bar on pre-API Level 11 devices), you would inherit from android.support.v4.app.FragmentActivity. This is the fragment-capable activity base class supplied by the Android Support package.

3. If you are using ActionBarSherlock, inherit from SherlockFragmentActivity.

### The Result

Visually, there is no difference between this version and the previous one, except that we now have an action bar:



*Figure 151: A Static Fragment on Android 2.3.3*

### The Fragment Lifecycle Methods

Fragments have lifecycle methods, just like activities do. In fact, they support all the same lifecycle methods as activities:

- onCreate()
- onStart() and onRestart()
- onResume()
- onPause()
- onStop()
- onDestroy()

By and large, the same rules apply for fragments as do for activities with respect to these lifecycle methods (e.g., `onDestroy()` may not be called).

In addition to those and the `onCreateView()` method we examined earlier in this chapter, there are four other lifecycle methods that you can elect to override if you so choose.

`onAttach()` will be called first, even before `onCreate()`, letting you know that your fragment has been attached to an activity. You are passed the `Activity` that will host your fragment.

`onActivityCreated()` will be called after `onCreate()` and `onCreateView()`, to indicate that the activity's `onCreate()` has completed. If there is something that you need to initialize in your fragment that depends upon the activity's `onCreate()` having completed its work, you can use `onActivityCreated()` for that initialization work.

`onDestroyView()` is called before `onDestroy()`. This is the counterpart to `onCreateView()` where you set up your UI. If there are things that you need to clean up specific to your UI, you might put that logic in `onDestroyView()`.

`onDetach()` is called after `onDestroy()`, to let you know that your fragment has been disassociated from its hosting activity.

## Your First Dynamic Fragment

Static fragments are fairly simple, once you have the `Fragment` implementation: just add the `<fragment>` element to where you want to have the fragment appear in your activity's layout.

That simplicity, though, does come with some costs. We will review some of those limitations [in the next chapter](#).

Those limitations can be overcome by the use of dynamic fragments. Rather than indicating to Android that you wish to use a fragment by means of a `<fragment>` element in a layout, you will use a `FragmentManager` to add a fragment at runtime from your Java code.

With that in mind, take a look at the [Fragments/Dynamic](#) sample project.

This is the same project as the one for static fragments, except this time we will adjust `OtherActivity` to use a dynamic fragment, specifically a `ListFragment`.

### The `ListFragment` Class

`ListFragment` serves the same role for fragments as `ListActivity` does for activities. It wraps up a `ListView` for convenient use. So, to have a more interesting `OtherActivity`, we start with an `OtherFragment` that is a `ListFragment`, designed to show our favorite 25 nonsense words as seen in previous examples.

However, since we are using `ActionBarSherlock` in this project, we need to use `SherlockListFragment`, to ensure that we will work well with the replacement action bar.

Just as a `ListActivity` does not need to call `setContentView()`, a `ListFragment` does not need to override `onCreateView()`. By default, the entire fragment will be comprised of a single `ListView`. And just as `ListActivity` has a `setListAdapter()` method to associate an `Adapter` with the `ListView`, so too does `ListFragment`:

```
package com.commonware.android.dfrag;

import android.app.Activity;
import android.os.Bundle;
import android.util.Log;
import android.widget.ArrayAdapter;
import com.actionbarsherlock.app.SherlockListFragment;

public class OtherFragment extends SherlockListFragment {
    private static final String[] items= { "lorem", "ipsum", "dolor",
        "sit", "amet", "consectetuer", "adipiscing", "elit", "morbi",
        "vel", "ligula", "vitae", "arcu", "aliquet", "mollis", "etiam",
        "vel", "erat", "placerat", "ante", "porttitor", "sodales",
        "pellentesque", "augue", "purus" };

    @Override
    public void onActivityCreated(Bundle savedInstanceState) {
        super.onActivityCreated(savedInstanceState);

        setListAdapter(new ArrayAdapter<String>(getActivity(),
            android.R.layout.simple_list_item_1, items));
    }
}
```

We call `setListAdapter()` in `onActivityCreated()`. In principle, we could call it any time after `onCreateView()` is processed, such as in `onResume()`.

This class also overrides many fragment lifecycle methods, logging their results, akin to our other `Fragment` and `LifecycleLoggingActivity`.

### The Activity Class

Now, `OtherActivity` no longer needs to load a layout — we have removed `res/layout/other.xml` from the project entirely. Instead, we will use a `FragmentManager` to add our fragment to the UI:

```
package com.commonware.android.dfrag;

import android.os.Bundle;

public class OtherActivity extends LifecycleLoggingActivity {
    @Override
    public void onCreate(Bundle savedInstanceState) {
        super.onCreate(savedInstanceState);

        if
(getSupportFragmentManager().findFragmentById(android.R.id.content)==null) {
            getSupportFragmentManager().beginTransaction()
                .add(android.R.id.content,
                    new OtherFragment()).commit();
        }
    }
}
```

To work with a `FragmentManager`, you need the `FragmentManager`. This object knows about all of the fragments that exist in your activity. If you are using the native API Level 11 edition of fragments, you can get your `FragmentManager` by calling `getFragmentManager()`. If you are using the Android Support package, as we are here, you need to call `getSupportFragmentManager()` instead.

Given a `FragmentManager`, you can start a `FragmentManager` by calling `beginTransaction()`, which returns the `FragmentManager` object. `FragmentManager` operates on the builder pattern, so most methods on `FragmentManager` return the `FragmentManager` itself, so you can chain a series of method calls one after the next.

We call two methods on our `FragmentManager`: `add()` and `commit()`. The `add()` method, as you might guess, indicates that we want to add a fragment to the UI. We supply the actual fragment object, in this case by creating a new `OtherFragment`. We also need to indicate where in our layout we want this fragment to reside. Had we loaded a layout, we could drop this fragment in any desired container. In our case, since we did not load a layout, we supply `android.R.id.content` as the ID of the

## THE TACTICS OF FRAGMENTS

---

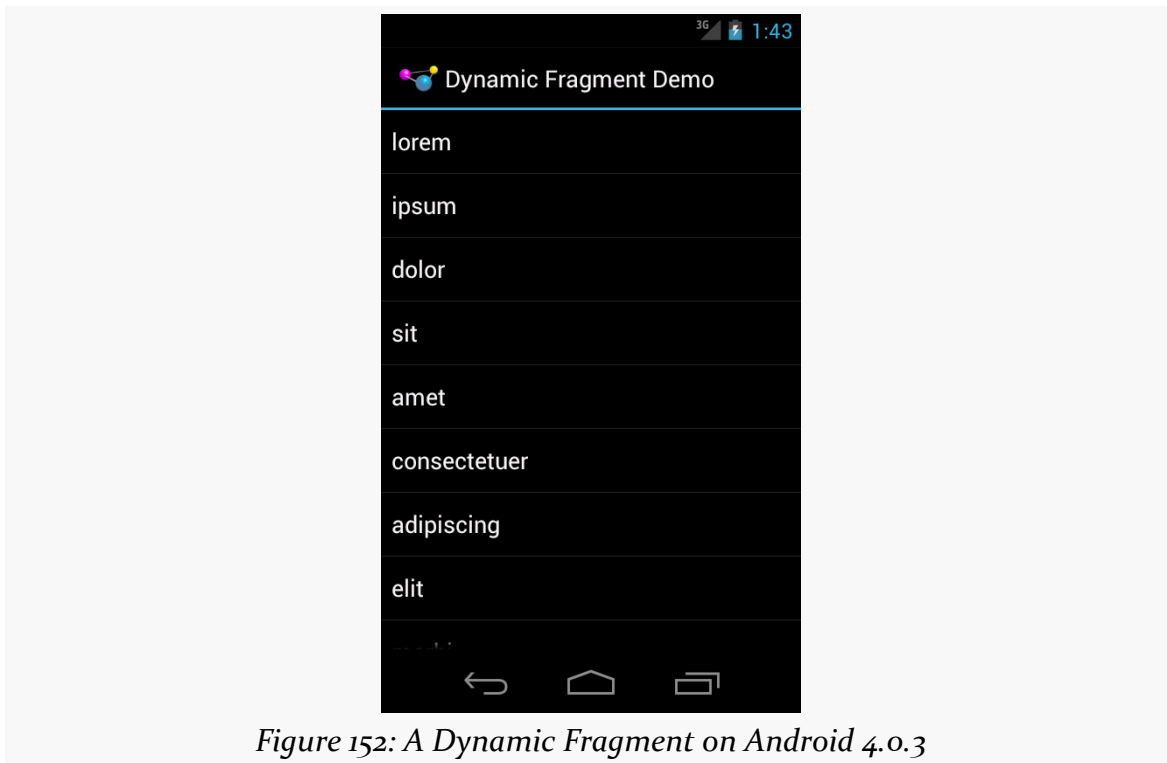
container to hold our fragment's View. Here, `android.R.id.content` identifies the container into which the results of `setContentView()` would go — it is a container supplied by Activity itself and serves as the top-most container for our content.

Just calling `add()` is insufficient. We then need to call `commit()` to make the transaction actually happen.

You might be wondering why we are trying to find a fragment in our `FragmentManager` before actually creating the fragment. We do that to help deal with configuration changes, and we will be exploring that further in the next chapter.

### The Result

Our `OtherActivity` looks identical to the `Selection/List` sample [from an earlier chapter](#), except that it sports the action bar courtesy of our `ActionBarSherlock` implementation:



*Figure 152: A Dynamic Fragment on Android 4.0.3*

## Fragments and the Action Bar

Fragments can add items to the action bar by calling `setHasOptionsMenu(true)` from `onActivityCreated()` (or any earlier lifecycle method). This indicates to the activity that it needs to call `onCreateOptionsMenu()` and `onOptionsItemSelected()` on the fragment.

The [Fragments/ActionBar](#) sample application demonstrates this. This is the same as the `ActionBar/ActionBarDemo` sample from [the chapter on the action bar](#), just with the activity converted into a dynamic fragment.

In `onActivityCreated()` of `ActionBar` fragment, we call `setHasOptionsMenu(true)`:

```
@Override
public void onActivityCreated(Bundle savedInstanceState) {
    super.onActivityCreated(savedInstanceState);

    setRetainInstance(true);
    setHasOptionsMenu(true);

    if (adapter == null) {
        initAdapter();
    }
}
```

(we will discuss that `setRetainInstance(true)` call [in a later chapter](#))

That will trigger our fragment's `onCreateOptionsMenu()` and `onOptionsItemSelected()` methods to be called at the appropriate time:

```
@Override
public void onCreateOptionsMenu(Menu menu, MenuInflater inflater) {
    inflater.inflate(R.menu.actions, menu);

    configureActionItem(menu);

    super.onCreateOptionsMenu(menu, inflater);
}

@Override
public boolean onOptionsItemSelected(MenuItem item) {
    if (item.getItemId() == R.id.reset) {
        initAdapter();
        return true;
    }

    return super.onOptionsItemSelected(item);
}
```



Here, we initialize our action bar from the `R.menu.actions` menu XML resource, including setting up our `EditText` widget, plus the logic to respond to the reset action overflow item.

Our activity does not need to do anything special to allow the fragment to contribute to the action bar — it just sets up the dynamic fragment:

```
package com.commonware.android.abf;

import android.os.Bundle;
import com.actionbarsherlock.app.SherlockFragmentActivity;

public class ActionBarFragmentActivity extends SherlockFragmentActivity {
    @Override
    public void onCreate(Bundle savedInstanceState) {
        super.onCreate(savedInstanceState);

        if
(getSupportFragmentManager().findFragmentById(android.R.id.content)==null) {
            getSupportFragmentManager().beginTransaction()
                .add(android.R.id.content,
                    new ActionBarFragment()).commit();
        }
    }
}
```

## Fragments Within Fragments: Just Say “Maybe”

Historically, one major limitation with fragments is that they could not contain other fragments. In most cases, this does not pose a major problem. However, there will be times when you might trip over this limitation, such as when using a `ViewPager`, as will be described in [a later chapter](#).

Android 4.2 — and a new edition of the Android Support package also released in November 2012 — added support for nested fragments. Whereas an activity works with fragments via a `FragmentManager` obtained via `getFragmentManager()` or `getSupportFragmentManager()`, fragments can work with nested fragments via a call to `getChildFragmentManager()`.

However, Android 3.0 through 4.1 have a version of fragments that does not have `getChildFragmentManager()`. Hence, you have two options:

1. Use the Android Support package’s backport of fragments, until such time as you can drop support for Android 4.1 and earlier (perhaps 2015), or
2. Do not use nested fragments for the time being

We will see how `getChildFragmentManager()` works in [the chapter on ViewPager](#).

## Fragments and Multiple Activities

A fragment should handle functionality purely within the fragment itself. Anything outside the fragment should be the responsibility of the calling activity. For example, if the user taps on an item in a `ListFragment`, and the effects of that event might go beyond what is inside the `ListFragment` itself, the `ListFragment` should forward the event to the hosting activity, so it can perhaps perform additional steps (e.g., launch an activity, update another fragment hosted by the activity).

As we will see [in a later chapter](#), it is entirely possible — perhaps even likely — that some of our fragments will be hosted by multiple different activities. For example, we might have a fragment that is hosted in one case by an activity designed for larger screens (e.g., tablets) and in another case by an activity designed for smaller screens (e.g., phones).

In these cases, the fragment does not know at compile time which activity class will be hosting it at runtime. For those cases, you have two major options:

1. Have the activities implement a common interface, and have the fragment cast the result of calling `getActivity()` to that interface, so it can call methods on the hosting activity without knowing its exact implementation.
2. Have the activities supply a listener object, with a common interface, to the fragment via a setter, and have the fragment use that listener for raising events and so on.

We will see much more on this subject when we get into large-screen strategies [in a later chapter](#).



# **Tutorial #9 - Starting Our Fragments**

---

Much of the content of a digital book to be viewed in EmPubLite will be in the form of HTML and related assets (CSS, images, etc.). Hence, we will eventually need to render our content in a WebView widget, for best results with semi-arbitrary HTML content.

To do this, we will set up fragments for the bits of content:

- each chapter
- other material, like our “help” and “about” pages

Right now, we will focus on just setting up some of the basic classes for these fragments — we will load them up with content and display them over the next few tutorials.

This is a continuation of the work we did in [the previous tutorial](#).

You can find [the results of the previous tutorial](#) and [the results of this tutorial](#) in [the book's GitHub repository](#).

Note that if you are importing the previous code to begin work here, you will also need the [copy of ActionBarSherlock in this book's GitHub repository](#), and to make sure that your imported EmPubLite project references the ActionBarSherlock project as a library.

## **Step #1: Copy In WebViewFragment**

Android has, as of Android 3.0, a WebViewFragment class. Just as ListFragment wraps a ListView in a Fragment, WebViewFragment wraps a WebView in a Fragment.

## TUTORIAL #9 - STARTING OUR FRAGMENTS

---

However, for unclear reasons, `WebViewFragment` was not put in the Android Support package. Nor does `ActionBarSherlock` contain a `SherlockWebViewFragment`.

Fortunately, Android is open source.

So, we will incorporate a slightly-modified version of the open source `WebViewFragment` into our application, to use as the basis for our fragments showing book content.

If you wish to make this change using Eclipse's wizards and tools, follow the instructions in the "Eclipse" section below. Otherwise, follow the instructions in the "Outside of Eclipse" section (appears after the "Eclipse" section).

### Eclipse

Right click over the `com.commonware.empublite` package in the `src/` folder of your project, and choose `New > Class` from the context menu. Fill in `WebViewFragment` in the "Name" field. Then, click the "Browse..." button next to the "Superclass" field and find `SherlockFragment` to set as the superclass. Click "Finish" on the new-class dialog to create the mostly-empty `WebViewFragment`.

Then, with the newly-created `WebViewFragment` open in the editor, replace its entire contents with the following:

```
/*
 * Copyright (C) 2010 The Android Open Source Project
 * Portions Copyright (c) 2012 CommonsWare, LLC
 *
 * Licensed under the Apache License, Version 2.0 (the "License");
 * you may not use this file except in compliance with the License.
 * You may obtain a copy of the License at
 *
 *     http://www.apache.org/licenses/LICENSE-2.0
 *
 * Unless required by applicable law or agreed to in writing, software
 * distributed under the License is distributed on an "AS IS" BASIS,
 * WITHOUT WARRANTIES OR CONDITIONS OF ANY KIND, either express or implied.
 * See the License for the specific language governing permissions and
 * limitations under the License.
 */

//package android.webkit;
package com.commonware.empublite;

import android.annotation.TargetApi;
import android.os.Build;
```

## TUTORIAL #9 - STARTING OUR FRAGMENTS

---

```
import android.os.Bundle;
import android.view.LayoutInflater;
import android.view.View;
import android.view.ViewGroup;
import android.webkit.WebView;
import com.actionbarsherlock.app.SherlockFragment;

/**
 * A fragment that displays a WebView.
 * <p>
 * The WebView is automatically paused or resumed when the
 * Fragment is paused or resumed.
 */
public class WebViewFragment extends SherlockFragment {
    private WebView mWebView;
    private boolean mIsWebViewAvailable;

    public WebViewFragment() {
    }

    /**
     * Called to instantiate the view. Creates and returns the
     * WebView.
     */
    @Override
    public View onCreateView(LayoutInflater inflater,
                            ViewGroup container,
                            Bundle savedInstanceState) {
        if (mWebView != null) {
            mWebView.destroy();
        }

        mWebView=new WebView(getActivity());
        mIsWebViewAvailable=true;
        return mWebView;
    }

    /**
     * Called when the fragment is visible to the user and
     * actively running. Resumes the WebView.
     */
    @TargetApi(11)
    @Override
    public void onPause() {
        super.onPause();

        if (Build.VERSION.SDK_INT >= Build.VERSION_CODES.HONEYCOMB) {
            mWebView.onPause();
        }
    }

    /**
     * Called when the fragment is no longer resumed. Pauses
     * the WebView.
     */
}
```

## TUTORIAL #9 - STARTING OUR FRAGMENTS

---

```
*/
@TargetApi(11)
@Override
public void onResume() {
    if (Build.VERSION.SDK_INT >= Build.VERSION_CODES.HONEYCOMB) {
        mWebView.onResume();
    }

    super.onResume();
}

/**
 * Called when the WebView has been detached from the
 * fragment. The WebView is no longer available after this
 * time.
 */
@Override
public void onDestroyView() {
    mIsWebViewAvailable=false;
    super.onDestroyView();
}

/**
 * Called when the fragment is no longer in use. Destroys
 * the internal state of the WebView.
 */
@Override
public void onDestroy() {
    if (mWebView != null) {
        mWebView.destroy();
        mWebView=null;
    }
    super.onDestroy();
}

/**
 * Gets the WebView.
 */
public WebView getWebView() {
    return mIsWebViewAvailable ? mWebView : null;
}
}
```

### Outside of Eclipse

Create a `src/com/commonsware/empublite/WebViewFragment.java` source file, with the content shown in the code listing above.

## Step #2: Examining WebViewFragment

The implementation of `WebViewFragment` we just created is almost identical to the one you will find in the Android open source project. Here are the highlights:

- `onCreateView()`, when first run, will create a new `WebView` object via its constructor, holding onto it as `mWebView`. `onCreateView()` also has an optimization to speed things up in situations such as when the screen is rotated, but the details of this are beyond the scope of this chapter.
- `onPause()` and `onResume()` invoke their corresponding methods on the `WebView` object. However, `onPause()` and `onResume()` were only added to the Android SDK with API Level 11. Since we want to use `WebViewFragment` on older devices, we use some tricks to make sure we only call `onPause()` and `onResume()` on the `WebView` when we are running on API Level 11 or higher. We will discuss the particular techniques shown here in an [upcoming chapter on backwards compatibility](#).
- `onDestroyView()` sets a flag to indicate that we should no longer be using the `WebView` — this flag is used by the `getWebView()` method that provides the `WebView` to subclasses of `WebViewFragment`.
- `onDestroy()` calls `destroy()` on the `WebView`, to proactively clean up some memory that it holds

Also, please forgive the erroneous JavaDoc comments for the `onPause()` and `onResume()` methods, which are flipped. That is the way the code appears in the Android Open Source Project, and those flaws were left intact in the backport of this class.

## Step #3: Creating AbstractContentFragment

`WebViewFragment` is nice, but it is mostly just a manager of various lifecycle behaviors. We need to further customize the way we use that `WebView` widget, so we will add those refinements in another class, `AbstractContentFragment`.

If you wish to make this change using Eclipse's wizards and tools, follow the instructions in the "Eclipse" section below. Otherwise, follow the instructions in the "Outside of Eclipse" section (appears after the "Eclipse" section).



### Eclipse

Right click over the `com.commonware.empublite` package in the `src/` folder of your project, and choose `New > Class` from the context menu. Fill in `AbstractContentFragment` in the “Name” field. Then, click the “Browse...” button next to the “Superclass” field and find `WebViewFragment` to set as the superclass — but make sure you choose the one in the `com.commonware.empublite` package, not the one in `android.webkit`. Then, click “Finish” on the new-class dialog to create the `AbstractContentFragment` class.

Then, with the newly-created `AbstractContentFragment` open in the editor, replace its entire contents with the following:

```
package com.commonware.empublite;

import android.annotation.SuppressLint;
import android.os.Bundle;
import android.view.LayoutInflater;
import android.view.View;
import android.view.ViewGroup;

abstract public class AbstractContentFragment extends WebViewFragment {
    abstract String getPage();

    @Override
    public void onCreate(Bundle savedInstanceState) {
        super.onCreate(savedInstanceState);
        setRetainInstance(true);
    }

    @SuppressWarnings("SetJavaScriptEnabled")
    @Override
    public View onCreateView(LayoutInflater inflater,
                            ViewGroup container,
                            Bundle savedInstanceState) {
        View result=
            super.onCreateView(inflater, container, savedInstanceState);

        getWebView().getSettings().setJavaScriptEnabled(true);
        getWebView().getSettings().setSupportZoom(true);
        getWebView().getSettings().setBuiltInZoomControls(true);
        getWebView().loadUrl(getPage());

        return(result);
    }
}
```

### Outside of Eclipse

Create a `src/com/commonsware/empublite/AbstractContentFragment.java` source file, with the content shown in the code listing above.

### Step #4: Examining AbstractContentFragment

`AbstractContentFragment` has but two methods:

- `onCreate()`, where we call `setRetainInstance(true)` — the utility of this will be examined in greater detail [in an upcoming chapter](#).
- `onCreateView()`, where we chain to the superclass (to have it create the `WebView`), then configure it to accept JavaScript and support zoom operations. We then have it load some content, retrieved in the form of a URL from an abstract `getPage()` method. Finally, we return what the superclass returned from `onCreateView()` — effectively, we are simply splicing in our own configuration logic.

### In Our Next Episode...

... we will [set up horizontal swiping](#) of book chapters in our tutorial project.



# Swiping with ViewPager

---

Android, over the years, has put increasing emphasis on UI design and having a fluid and consistent user experience (UX). While some mobile operating systems take “the stick” approach to UX (forcing you to abide by certain patterns or be forbidden to distribute your app), Android takes “the carrot” approach, offering widgets and containers that embody particular patterns that they espouse. The action bar, for example, grew out of this and is now the backbone of many Android activities.

Another example is the ViewPager, which allows the user to swipe horizontally to move between different portions of your content. However, ViewPager is not distributed as part of the firmware, but rather via the Android Support package, alongside the backport of the fragments framework. Hence, even though ViewPager is a relatively new widget, you can use it on Android 1.6 and up.

This chapter will focus on where you should apply a ViewPager and how to set one up.

## Swiping Design Patterns

In 2012, Google released the [Android Design Web site](#) as an adjunct to the existing developer documentation. This site outlines many aspects of UI and UX design for Android, from recommended sizing to maintaining platform fidelity instead of mimicking another mobile operating system.

They have [a page dedicated to “swipe views”](#), where they outline the scenario for using horizontal swiping: moving from peer to peer in sequence in a collection of content:

- Email messages in a folder or label

- Chapters in an ebook
- Tabs in a collection of tabs

The primary way to implement this pattern in Android is the `ViewPager`.

## Paging Fragments

The simplest way to use a `ViewPager` is to have it page fragments in and out of the screen based on user swipes. Android has some built-in support for using fragments inside of `ViewPager` that make it fairly easy to use.

To see this in action, this section will examine the [ViewPager/Fragments](#) sample project.

### The Prerequisites

The project has a dependency on the Android Support package, in order to be able to use `ViewPager`. And, as do most of this book's samples from this point forward, it also depends upon `ActionBarSherlock`, so we can have an action bar while still supporting Android 2.1 and beyond.

### The Activity Layout

The layout used by the activity just contains the `ViewPager`. Note that since `ViewPager` is not in the `android.widget` package, we need to fully-qualify the class name in the element:

```
<?xml version="1.0" encoding="utf-8"?>
<android.support.v4.view.ViewPager xmlns:android="http://schemas.android.com/apk/res/android"
    android:id="@+id/pager"
    android:layout_width="fill_parent"
    android:layout_height="fill_parent">
</android.support.v4.view.ViewPager>
```

### The Activity

The `ViewPagerFragmentDemoActivity` loads that layout file directly, not delegating it to a fragment, as we are going to put fragments *inside* the `ViewPager`, and we cannot have fragments inside other fragments.

And, as you see, the activity itself is blissfully small:

## SWIPING WITH VIEWPAGER

---

```
package com.commonsware.android.pager;

import android.os.Bundle;
import android.support.v4.view.ViewPager;
import com.actionbarsherlock.app.SherlockFragmentActivity;

public class ViewPagerFragmentDemoActivity extends
    SherlockFragmentActivity {
    @Override
    public void onCreate(Bundle savedInstanceState) {
        super.onCreate(savedInstanceState);
        setContentView(R.layout.main);

        ViewPager pager=(ViewPager)findViewById(R.id.pager);

        pager.setAdapter(new SampleAdapter(getSupportFragmentManager()));
    }
}
```

All we do is load the layout, retrieve the ViewPager via `findViewById()`, and provide a `SampleAdapter` to the ViewPager via `setAdapter()`.

### The PagerAdapter

AdapterView classes, like `ListView`, work with Adapter objects, like `ArrayAdapter`. `ViewPager`, however, is not an AdapterView, despite adopting many of the patterns from AdapterView. `ViewPager`, therefore, does not work with an Adapter, but instead with a `PagerAdapter`, which has a slightly different API.

Android ships two `PagerAdapter` implementations in the Android Support package: `FragmentPagerAdapter` and `FragmentStatePagerAdapter`. The former is good for small numbers of fragments, where holding them all in memory at once will work. `FragmentStatePagerAdapter` is for cases where holding all possible fragments to be viewed in the `ViewPager` would be too much, where Android will discard fragments as needed and hold onto the (presumably smaller) states of those fragments instead.

For the moment, we will focus on `FragmentPagerAdapter`.

Our `SampleAdapter` inherits from `FragmentPagerAdapter` and implements two required callback methods:

- `getCount()`, to indicate how many pages will be in the `ViewPager`, and
- `getItem()`, which returns a `Fragment` for a particular position within the `ViewPager` (akin to `getView()` in a classic Adapter)

---

## SWIPING WITH VIEWPAGER

---

```
package com.commonware.android.pager;

import android.support.v4.app.Fragment;
import android.support.v4.app.FragmentManager;
import android.support.v4.app.FragmentManagerAdapter;

public class SampleAdapter extends FragmentPagerAdapter {
    public SampleAdapter(FragmentManager mgr) {
        super(mgr);
    }

    @Override
    public int getCount() {
        return(10);
    }

    @Override
    public Fragment getItem(int position) {
        return(EditorFragment.newInstance(position));
    }
}
```

Here, we say that there will be 10 pages total, each of which will be an instance of an EditorFragment.

### The Fragment

EditorFragment will host a full-screen EditText widget, for the user to enter in a chunk of prose, as is defined in the `res/layout/editor.xml` resource:

```
<EditText xmlns:android="http://schemas.android.com/apk/res/android"
    android:id="@+id/editor"
    android:layout_width="match_parent"
    android:layout_height="match_parent"
    android:inputType="textMultiLine"
    android:gravity="left|top"
/>
```

We want to pass the position number of the fragment within the ViewPager, simply to customize the hint displayed in the EditText before the user types in anything. With normal Java objects, you might pass this in via the constructor, but it is not a good idea to implement a constructor on a Fragment. Instead, the recipe is to create a static factory method (typically named `newInstance()`) that will create the Fragment and provide the parameters to it by updating the fragment's "arguments" (a Bundle):

```
static EditorFragment newInstance(int position) {
    EditorFragment frag=new EditorFragment();
```

---

## SWIPING WITH VIEWPAGER

---

```
Bundle args=new Bundle();

args.putInt(KEY_POSITION, position);
frag.setArguments(args);

return(frag);
}
```

In onCreateView() we inflate our R.layout.editor resource, get the EditText from it, get our position from our arguments, format a hint containing the position (using a string resource), and setting the hint on the EditText:

```
@Override
public View onCreateView(LayoutInflater inflater,
                        ViewGroup container,
                        Bundle savedInstanceState) {
    View result=inflater.inflate(R.layout.editor, container, false);
    EditText editor=(EditText)result.findViewById(R.id.editor);
    int position=getArguments().getInt(KEY_POSITION, -1);

    editor.setHint(String.format(getString(R.string.hint), position + 1));

    return(result);
}
```

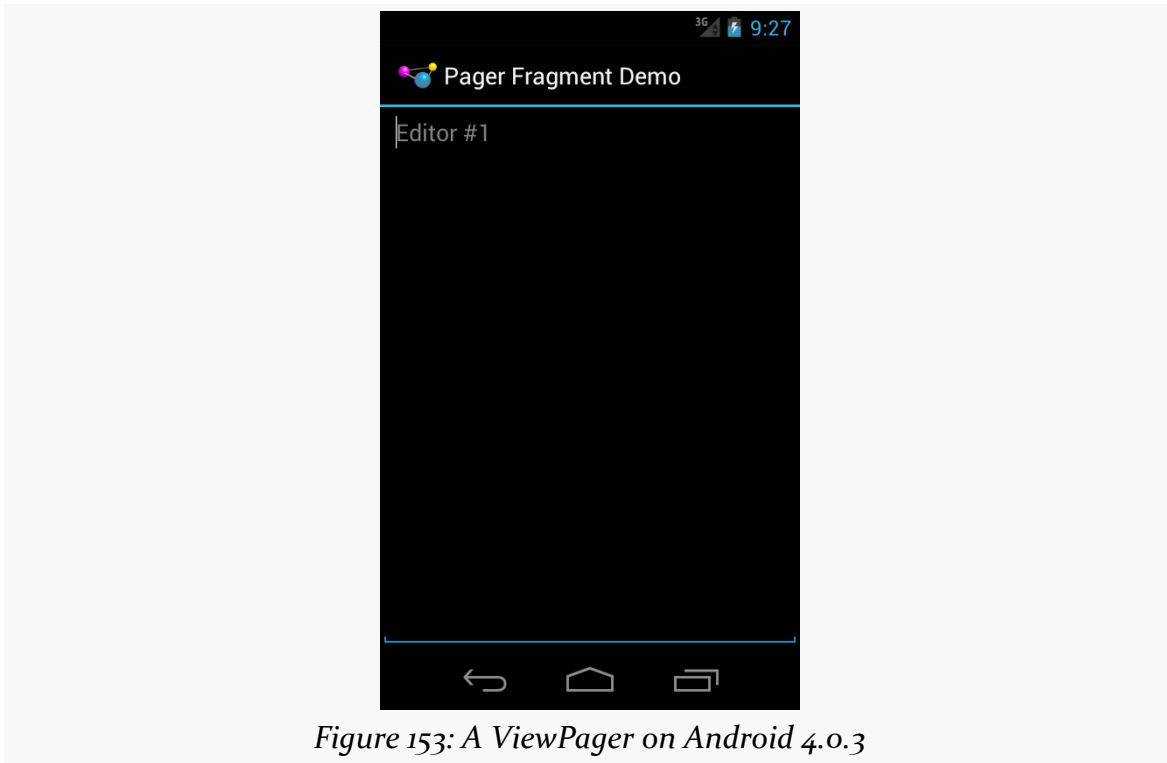
### The Result

When initially launched, the application shows the first fragment:



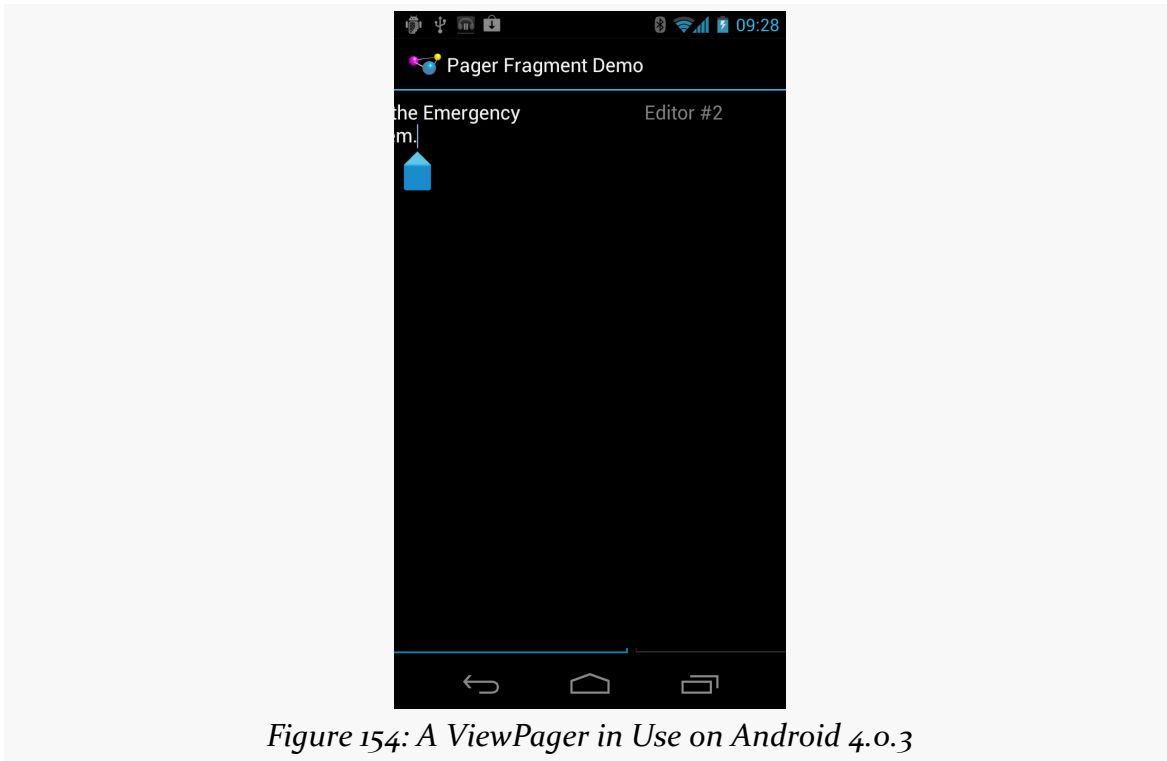
## SWIPING WITH VIEWPAGER

---



*Figure 153: A ViewPager on Android 4.0.3*

However, you can horizontally swipe to get to the next fragment:



*Figure 154: A ViewPager in Use on Android 4.0.3*

Swiping works in both directions, so long as there is another fragment in your desired direction.

## Paging Other Stuff

You do not have to use fragments inside a ViewPager. A regular PagerAdapter actually hands View objects to the ViewPager. The supplied fragment-based PagerAdapter implementations get the View from a fragment and use that, but you are welcome to create your own PagerAdapter that eschews fragments. The primary reason for this would be to allow you to have the ViewPager itself be inside a fragment.

## Indicators

By itself, there is no visual indicator of where the user is within the set of pages contained in the ViewPager. In many instances, this will be perfectly fine, as the pages themselves will contain cues as to position. However, even in those cases, it may not be completely obvious to the user how many pages there are, which directions for swiping are active, etc.

Hence, you may wish to attach some other widget to the ViewPager that can help clue the user into where they are within “page space”.

### PagerTitleStrip and PagerTabStrip

The primary built-in indicator options available to use are PagerTitleStrip and PagerTabStrip. As the name suggests, PagerTitleStrip is a strip that shows titles of your pages. PagerTabStrip is much the same, but the titles are formatted somewhat like tabs, and they are clickable (switching you to the clicked-upon page), whereas PagerTitleStrip is non-interactive.

To use either of these, you first must add it to your layout, inside your ViewPager, as shown in the `res/layout/main.xml` resource of the [ViewPager/Indicator](#) sample project, a clone of the ViewPager/Fragments project that adds a PagerTabStrip to our UI:

```
<?xml version="1.0" encoding="utf-8"?>
<android.support.v4.view.ViewPager xmlns:android="http://schemas.android.com/apk/res/android"
    android:id="@+id/pager"
    android:layout_width="fill_parent"
    android:layout_height="fill_parent">

    <android.support.v4.view.PagerTabStrip
        android:layout_width="fill_parent"
        android:layout_height="wrap_content"
        android:layout_gravity="top"/>

</android.support.v4.view.ViewPager>
```

Here, we set the `android:layout_gravity` of the PagerTabStrip to `top`, so it appears above the pages. You could similarly set it to `bottom` to have it appear below the pages.

Our SampleAdapter needs another method: `getPageTitle()`, which will return the title to display in the PagerTabStrip for a given position:

```
package com.commonware.android.pager2;

import android.content.Context;
import android.support.v4.app.Fragment;
import android.support.v4.app.FragmentManager;
import android.support.v4.app.FragmentPagerAdapter;

public class SampleAdapter extends FragmentPagerAdapter {
    Context ctxt=null;
```

## SWIPING WITH VIEWPAGER

---

```
public SampleAdapter(Context ctxt, FragmentManager mgr) {
    super(mgr);
    this.ctxt=ctxt;
}

@Override
public int getCount() {
    return(10);
}

@Override
public Fragment getItem(int position) {
    return(EditorFragment.newInstance(position));
}

@Override
public String getPageTitle(int position) {
    return(EditorFragment.getTitle(ctxt, position));
}
}
```

Here, we call a static getTitle() method on EditorFragment. That is a refactored bit of code from our former onCreateView() method, where we create the string for the hint — we will use the hint text as our page title:

```
package com.commonware.android.pager2;

import android.content.Context;
import android.os.Bundle;
import android.view.LayoutInflater;
import android.view.View;
import android.view.ViewGroup;
import android.widget.EditText;
import com.actionbarsherlock.app.SherlockFragment;

public class EditorFragment extends SherlockFragment {
    private static final String KEY_POSITION="position";

    static EditorFragment newInstance(int position) {
        EditorFragment frag=new EditorFragment();
        Bundle args=new Bundle();

        args.putInt(KEY_POSITION, position);
        frag.setArguments(args);

        return(frag);
    }

    static String getTitle(Context ctxt, int position) {
        return(String.format(ctxt.getString(R.string.hint), position + 1));
    }
}
```

---

## SWIPING WITH VIEWPAGER

---

```
@Override
public View onCreateView(LayoutInflater inflater,
                        ViewGroup container,
                        Bundle savedInstanceState) {
    View result=inflater.inflate(R.layout.editor, container, false);
    EditText editor=(EditText)result.findViewById(R.id.editor);
    int position=getArguments().getInt(KEY_POSITION, -1);

    editor.setHint(getTitle(getActivity(), position));

    return(result);
}
}
```

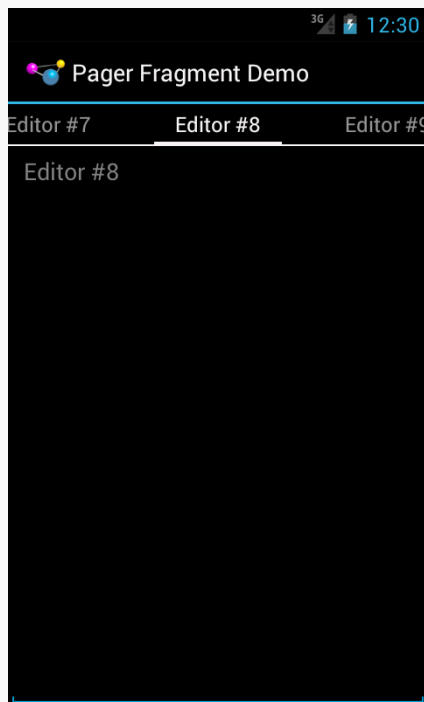


Figure 155: A ViewPager and PagerTabStrip on Android 4.0.3

Note that PagerTabStrip was added after the original version of the Android Support package. If you are encountering problems finding PagerTabStrip, you may be using an older copy of the Android Support package (e.g., one that may have shipped with ActionBarSherlock).

### Third-Party Indicators

If you want something else for your indicators, besides a strip of page titles, you might wish to check out the [ViewPagerIndicator library](#), brought to you by the

author of ActionBarSherlock. This library contains a series of widgets that serve in the same role as PagerTitleStrip, with different looks.

## Fragment-Free Paging

What if you want ViewPager to page things other than fragments?

The solution is to not use FragmentPagerAdapter or FragmentStatePagerAdapter, but instead create your own implementation of the PagerAdapter interface, one that avoids the use of fragments.

We will see an example of this [in a later chapter](#), where we also examine [how to have more than one page of the ViewPager be visible at a time](#).

## Hosting ViewPager in a Fragment

Classically, the primary restriction on ViewPager was that you could not both have ViewPager be in a fragment *and* have ViewPager host fragments as its pages. You could do one or the other, but not both simultaneously.

As noted [in a previous chapter](#), Android 4.2 natively, and the latest Android Support package backport, does support nested fragments. Now you *can* have ViewPager be in a fragment and host fragments as its pages. However, it requires a minor modification to the way we set up our PagerAdapter, as is illustrated in the [ViewPager/Nested](#) sample project. This is the same project as ViewPager/Indicator, with the twist that the pages are fragments and the ViewPager is inside a fragment.

Our activity now implements the standard add-the-fragment-if-it-does-not-exist pattern that we have seen previously:

```
package com.commonware.android.pagernested;

import android.os.Bundle;
import android.support.v4.app.FragmentActivity;

public class ViewPagerIndicatorActivity extends FragmentActivity {
    @Override
    public void onCreate(Bundle savedInstanceState) {
        super.onCreate(savedInstanceState);

        if (getSupportFragmentManager().findFragmentById(android.R.id.content) ==
            null) {
            getSupportFragmentManager().beginTransaction()
```

## SWIPING WITH VIEWPAGER

---

```
        .add(android.R.id.content,
            new PagerFragment()).commit();
    }
}
```

This loads a PagerFragment, which contains most of the logic from our original activity:

```
package com.commonware.android.pagernested;

import android.os.Bundle;
import android.support.v4.app.Fragment;
import android.support.v4.view.PagerAdapter;
import android.support.v4.view.ViewPager;
import android.view.LayoutInflater;
import android.view.View;
import android.view.ViewGroup;

public class PagerFragment extends Fragment {
    @Override
    public View onCreateView(LayoutInflater inflater,
                             ViewGroup container,
                             Bundle savedInstanceState) {
        View result=inflater.inflate(R.layout.pager, container, false);
        ViewPager pager=(ViewPager)result.findViewById(R.id.pager);

        pager.setAdapter(buildAdapter());

        return(result);
    }

    private PagerAdapter buildAdapter() {
        return(new SampleAdapter(getActivity(), getChildFragmentManager()));
    }
}
```

The biggest difference is that our call to the constructor of SampleAdapter no longer uses `getSupportFragmentManager()`. Instead, it uses `getChildFragmentManager()`. This allows SampleAdapter to use fragments hosted by PagerFragment, rather than ones hosted by the activity as a whole.

No other code changes are required, and from the user's standpoint, there is no visible difference.

# **Tutorial #10 - Rigging Up a ViewPager**

A ViewPager is a fairly slick way to present a digital book. You can have individual chapters be accessed by horizontal swiping, with the prose within a chapter accessed by scrolling vertically. While not offering “page-at-a-time” models used by some book reader software, it is **much** simpler to set up.

So, that’s the approach we will use with EmPubLite. Which means, among other things, that we need to add a ViewPager to the app.

This is a continuation of the work we did in [the previous tutorial](#).

You can find [the results of the previous tutorial](#) and [the results of this tutorial](#) in [the book’s GitHub repository](#).

Note that if you are importing the previous code to begin work here, you will also need the [copy of ActionBarSherlock in this book’s GitHub repository](#), and to make sure that your imported EmPubLite project references the ActionBarSherlock project as a library.

## **Step #1: Add a ViewPager to the Layout**

Right now, the layout for EmPubLiteActivity just has a ProgressBar. We need to augment that to have our ViewPager as well, set up such that we can show either the ProgressBar (while we load the book) or the ViewPager as needed.

Unfortunately, this is the sort of change that the Eclipse drag-and-drop GUI building is not particularly well-suited for. Hence, even Eclipse users are going to have to dive into the layout XML this time.



## TUTORIAL #10 - RIGGING UP A VIEWPAGER

---

Open up `res/layout/main.xml` (and, if you are using Eclipse, switch to the “main.xml” sub-tab of the editor, to see the raw XML). As a child of the `<RelativeLayout>`, after the `<ProgressBar>`, add a `<android.support.v4.view.ViewPager>` element as follows:

```
<android.support.v4.view.ViewPager
    android:id="@+id/pager"
    android:layout_width="fill_parent"
    android:layout_height="fill_parent"
    android:visibility="gone"/>
```

This adds the `ViewPager`, also having it fill the parent, but with the visibility initially set to `gone`, meaning that the user will not see it.

The entire layout should now resemble:

```
<RelativeLayout xmlns:android="http://schemas.android.com/apk/res/android"
    xmlns:tools="http://schemas.android.com/tools"
    android:layout_width="match_parent"
    android:layout_height="match_parent"
    tools:context=".EmPubLiteActivity">

    <ProgressBar
        android:id="@+id/progressBar1"
        style="?android:attr/progressBarStyleLarge"
        android:layout_width="wrap_content"
        android:layout_height="wrap_content"
        android:layout_centerHorizontal="true"
        android:layout_centerVertical="true"/>

    <android.support.v4.view.ViewPager
        android:id="@+id/pager"
        android:layout_width="fill_parent"
        android:layout_height="fill_parent"
        android:visibility="gone"/>

</RelativeLayout>
```

## Step #2: Obtaining Our ViewPager

We will be referencing the `ViewPager` from a few places in the activity, so we may as well get a reference to it and hold onto it in a data member, for easy access.

Add a data member to `EmPubLiteActivity`:

```
private ViewPager pager=null;
```

---

## TUTORIAL #10 - RIGGING UP A VIEWPAGER

---

You will also need to add an import for `android.support.v4.view.ViewPager` to get this to compile.

Then, in `onCreate()`, after the call to `setContentView(R.layout.main)`, use `findViewById()` to retrieve the `ViewPager` and store it in the `pager` data member:

```
pager=(ViewPager)findViewById(R.id.pager);
```

If you are using Eclipse, you will see a warning that `pager` is not used – do not worry, as we will be using it soon enough.

### Step #3: Creating a ContentsAdapter

A `ViewPager` needs a `PagerAdapter` to populate its content, much like a `ListView` needs a `ListAdapter`. We cannot completely construct a `PagerAdapter` yet, as we still need to learn how to load up our book content from files. But, we can get part-way towards having a useful `PagerAdapter` now.

If you wish to make this change using Eclipse’s wizards and tools, follow the instructions in the “Eclipse” section below. Otherwise, follow the instructions in the “Outside of Eclipse” section (appears after the “Eclipse” section).

#### Eclipse

Right click over the `com.commonware.empublite` package in the `src/` folder of your project, and choose `New > Class` from the context menu. Fill in `ContentsAdapter` in the “Name” field. Then, click the “Browse...” button next to the “Superclass” field and find `FragmentManagerPagerAdapter` to set as the superclass. Then, click “Finish” on the new-class dialog to create the `ContentsAdapter` class.

This will immediately show an error in the Eclipse editor, as `FragmentManagerPagerAdapter` requires a public constructor, and we do not have one yet. So, add the following constructor implementation to the class:

```
public ContentsAdapter(SherlockFragmentActivity ctxt) {  
    super(ctxt.getSupportFragmentManager());  
}
```

This simply chains to the superclass, supplying the requisite `FragmentManager` instance, culled from our parent activity.

## TUTORIAL #10 - RIGGING UP A VIEWPAGER

---

You will need to import `com.actionbarsherlock.app.SherlockFragmentActivity` for this to compile.

### Outside of Eclipse

Create a `src/com/commonsware/empublite/ContentsAdapter.java` source file, with the following content:

```
package com.commonsware.empublite;

import android.support.v4.app.Fragment;
import android.support.v4.app.FragmentStatePagerAdapter;
import com.actionbarsherlock.app.SherlockFragmentActivity;

public class ContentsAdapter extends FragmentStatePagerAdapter {
    public ContentsAdapter(SherlockFragmentActivity ctxt) {
        super(ctxt.getSupportFragmentManager());
    }

    @Override
    public Fragment getItem(int position) {
        return null;
    }

    @Override
    public int getCount() {
        return 0;
    }
}
```

### Step #4: Setting Up the ViewPager

Let's add a few more lines to the bottom of `onCreate()` of `EmPubLiteActivity`, to set up `ContentsAdapter` and attach it to the `ViewPager`:

```
adapter=new ContentsAdapter(this);
pager.setAdapter(adapter);
findViewById(R.id.progressBar1).setVisibility(View.GONE);
findViewById(R.id.pager).setVisibility(View.VISIBLE);
```

This will require a new data member:

```
private ContentsAdapter adapter=null;
```

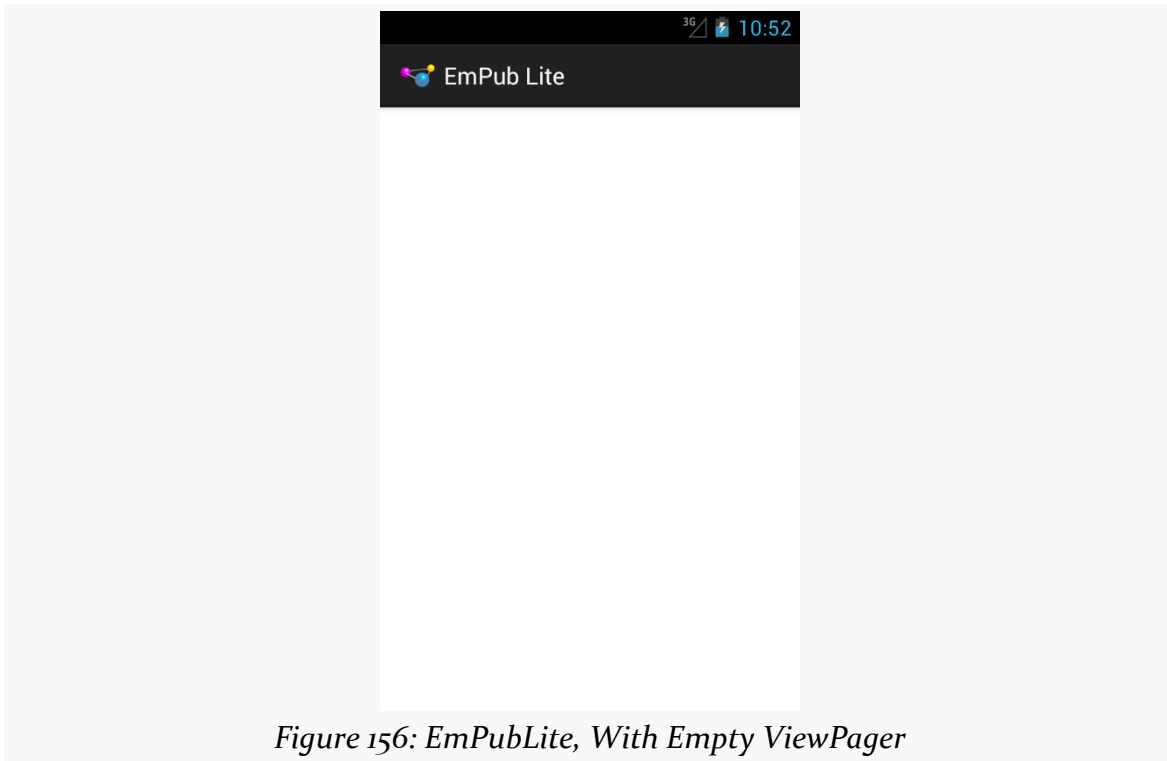
It will also require an import for `android.view.View`.

## TUTORIAL #10 - RIGGING UP A VIEWPAGER

---

What we are doing is creating our ContentsAdapter instance, associating it with the ViewPager, and toggling the visibility of the ProgressBar (making it GONE) and the ViewPager (making it VISIBLE).

The net effect, if you run this modified version of the app, is that we no longer see the ProgressBar. Instead, we have a big blank area, taken up by our empty ViewPager:



*Figure 156: EmPubLite, With Empty ViewPager*

The ViewPager is empty simply because our ContentsAdapter returned 0 from `getCount()`, indicating that there are no pages to be displayed.

## In Our Next Episode...

... we will [finish our “help” and “about” screens](#) in our tutorial project.



# Resource Sets and Configurations

---

Devices sometimes change while users are using them, in ways that our application will care about:

- The user might rotate the screen from portrait to landscape, or vice versa
- The user might put the device in a car or desk dock, or remove it from such a dock
- The user might put the device in a “netbook dock” that adds a full QWERTY keyboard, or remove it from such a dock
- The user might switch to a different language via the Settings application, returning to our running application afterwards
- And so on

In all of these cases, it is likely that we will want to change what resources we use. For example, our layout for a portrait screen may be too tall to use in landscape mode, so we would want to substitute in some other layout.

This chapter will explore how to provide alternative resources for these different scenarios — called “configuration changes” — and will explain what happens to our activities when the user changes the configuration while we are in the foreground.

## What’s a Configuration? And How Do They Change?

Different pieces of Android hardware can have different capabilities, such as:

- Different screen sizes
- Different screen densities (dots per inch)

- Different number and capabilities of cameras
- Different mix of radios (GSM? CDMA? GPS? Bluetooth? WiFi? NFC? something else?)
- And so on

Some of these, in the eyes of the core Android team, might drive the selection of resources, like layouts or drawables. Different screen sizes might drive the choice of layout. Different screen densities might drive the choice of drawable (using a higher-resolution image on a higher-density device). These are considered part of the device’s “configuration”.

Other differences — ones that do not drive the selection of resources — are not part of the device’s configuration but merely are “features” that some devices have and other devices do not. For example, cameras and Bluetooth and WiFi are features.

Some parts of a configuration will only vary based on different devices. A screen will not change density on the fly, for example. But some parts of a configuration can be changed during operation of the device, such as orientation (portrait vs. landscape) or language. When a configuration switches to something else, that is a “configuration change”, and Android provides special support for such events to help developers adjust their applications to match the new configuration.

## Configurations and Resource Sets

One set of resources may not fit all situations where your application may be used. One obvious area comes with string resources and dealing with internationalization (I18N) and localization (L10N). Putting strings all in one language works fine — probably at least for the developer — but only covers one language.

That is not the only scenario where resources might need to differ, though. Here are others:

1. *Screen orientation*: is the screen in a portrait orientation? Landscape? Is the screen square and, therefore, does not really have an orientation?
2. *Screen size*: is this something sized like a phone? A tablet? A television?
3. *Screen density*: how many dots per inch does the screen have? Will we need a higher-resolution edition of our icon so it does not appear too small?
4. *Touchscreen*: does the device have a touchscreen? If so, is the touchscreen set up to be used with a stylus or a finger?

5. *Keyboard*: what keyboard does the user have (QWERTY, numeric, neither), either now or as an option?
6. *Other input*: does the device have some other form of input, like a directional pad or click-wheel?

The way Android currently handles this is by having multiple resource directories, with the criteria for each embedded in their names.

Suppose, for example, you want to support strings in both English and Spanish. Normally, for a single-language setup, you would put your strings in a file named `res/values/strings.xml`. To support both English and Spanish, you would create two folders, `res/values-en/` and `res/values-es/`, where the value after the hyphen is the [ISO 639-1](#) two-letter code for the language you want. Your English-language strings would go in `res/values-en/strings.xml` and the Spanish ones in `res/values-es/strings.xml`. Android will choose the proper file based on the user's device settings.

An even better approach is for you to consider some language to be your default, and put those strings in `res/values/strings.xml`. Then, create other resource directories for your translations (e.g., `res/values-es/strings.xml` for Spanish). Android will try to match a specific language set of resources; failing that, it will fall back to the default of `res/values/strings.xml`. This way, if your app winds up on a device with a language that you do not expect, you at least serve up strings in your chosen default language. Otherwise, if there is no such default, you will wind up with a `ResourceNotFoundException`, and your application will crash.

This, therefore, is the bedrock resource set strategy: have a complete set of resources in the default directory (e.g., `res/layout/`), and override those resources in other resource sets tied to specific configurations as needed (e.g., `res/layout-land/`).

## Coping with Complexity

Where things start to get complicated is when you need to use multiple disparate criteria for your resources.

For example, suppose that you have drawable resources that are locale-dependent, such as a stop sign. You might want to have resource sets of drawables tied to language, so you can substitute in different images for different locales. However, you might also want to have those images vary by density, using higher-resolution



images on higher-density devices, so the images all come out around the same physical size.

To do that, you would wind up with directories with multiple resource set qualifiers, such as:

- `res/drawable-ldpi/`
- `res/drawable-mdpi/`
- `res/drawable-hdpi/`
- `res/drawable-xhdpi/`
- `res/drawable-en-rUK-ldpi/`
- `res/drawable-en-rUK-mdpi/`
- `res/drawable-en-rUK-hdpi/`
- `res/drawable-en-rUK-xhdpi/`
- And so on

(with the default language being, say, US English, using a US stop sign)

Once you get into these sorts of situations, though, a few rules come into play, such as:

1. The configuration options (e.g., `-en`) have a particular order of precedence, and they must appear in the directory name in that order. The [Android documentation](#) outlines the specific order in which these options can appear. For the purposes of this example, screen size is more important than screen orientation, which is more important than screen density, which is more important than whether or not the device has a keyboard.
2. There can only be one value of each configuration option category per directory.
3. Options are case sensitive

For example, you might want to have different layouts based upon screen size and orientation. Since screen size is more important than orientation in the resource system, the screen size would appear in the directory name ahead of the orientation, such as:

- `res/layout-xlarge-land/`
- `res/layout-xlarge/`
- `res/layout-land/`
- `res/layout/`

Android uses a specific algorithm for determining which, among a set of candidates, is the “right” resource directory to use for a given request:

- First, Android tosses out ones that are specifically invalid. So, for example, if the screen size of the device is “normal”, the `-large` directories would be dropped as candidates, since they call for some other size.
- Next, Android counts the number of matches for each folder, and only pays attention to those with the most matches.
- Finally, Android goes in the order of precedence of the options — in other words, it goes from left to right in the directory name.

In the above example, if we call `setContentView(R.layout.main)` on a device with an `-xlarge` screen held in the landscape orientation, Android will search the directories in the order shown above:

1. First, Android will use `res/layout-xlarge-land/main.xml`, if it exists
2. If not, Android will use `res/layout-xlarge/main.xml`, if it exists
3. If neither, Android will use `res/layout-land/main.xml`, if it exists
4. Finally, if nothing else matched, Android will use `res/layout/main.xml`, if it exists (and if it does not, it will raise a `ResourceNotFoundException`)

## Default Change Behavior

When you call methods in the Android SDK that load a resource (e.g., the aforementioned `setContentView(R.layout.main)`), Android will walk through those resource sets, find the right resource for the given request, and use it.

But what happens if the configuration changes *after* we asked for the resource? For example, what if the user was holding their device in portrait mode, then rotates the screen to landscape? We would want a `-land` version of our layouts, if such versions exist. And, since we already requested the resources, Android has no good way of handing us revised resources on the fly... except by forcing us to re-request those resources.

So, this is what Android does, by default, to our foreground activity, when the configuration changes on the fly.

### Destroy and Recreate the Activity

The biggest thing that Android does is destroy and recreate our activity. In other words:

- Android calls `onPause()`, `onStop()`, and `onDestroy()` on our original instance of the activity
- Android creates a brand new instance of the same activity class, using the same Intent that was used to create the original instance
- Android calls `onCreate()`, `onStart()`, and `onResume()` of the new activity instance
- The new activity appears on the screen

This may seem... invasive. You might not expect that Android would wipe out a perfectly good activity, just because the user flicked her wrist and rotated the screen of her phone. However, this is the only way Android has that guarantees that we will re-request all our resources.

### Rebuild the Fragments

If your activity is using fragments, the new instance of the activity will contain the same fragments that the old instance of the activity does. This includes both static and dynamic fragments.

By default, Android destroys and recreates the fragments, just as it destroys and recreates the activities. However, as we will see, we do have an option to tell Android to retain certain dynamic fragment instances — for those, it will have the new instance use the same fragment instances as were used by the old activity, instead of creating new instances from scratch.

### Recreate the Views

Regardless of whether or not Android recreates all of the fragments, it will call `onCreateView()` of all of the fragments (plus call `onDestroyView()` on the original set of fragments). In other words, Android recreates all of the widgets and containers, to pour them into the new activity instance.

### Retain Some Widget State

Android will hold onto the “instance state” of some of the widgets we have in our activity and fragments. Mostly, it holds onto obviously user mutable state, such as:

- What has been typed into an `EditText`
- Whether a `CompoundButton`, like a `CheckBox` or `RadioButton`, is checked or not
- Etc.

Android will collect this information from the widgets of the old activity instance, carry that data forward to the new activity instance, and update the new set of widgets to have that same state.

### Your Options for Configuration Changes

As noted, a configuration change is fairly invasive on your activity, replacing it outright with all new content (albeit with perhaps some information from the old activity’s widgets carried forward into the new activity’s widgets).

Hence, you have several possible approaches for handling configuration changes in any given activity.

#### Do Nothing

The easiest thing to do, of course, is to do nothing at all. If all your state is bound up in stuff Android handles automatically, you do not need to do anything more than the defaults.

For example, the `ViewPager/Fragments` demo from [the preceding chapter](#) works correctly “out of the box”. All of our “state” is tied up in `EditText` widgets, which Android handles automatically. So, we can type in stuff in a bunch of those widgets, rotate the screen (e.g., via `<Ctrl>-<F11>` in the emulator on a Windows or Linux PC), and our entered text is retained.

Alas, there are plenty of cases where the built-in behavior is either incomplete or simply incorrect, and we will need to do more work to make sure that our configuration changes are handled properly.

## Retain Your Fragments

The best approach nowadays for handling these sorts of configuration changes is to have Android retain a dynamic fragment.

Here, “retain” means that Android will keep the same fragment instance across the configuration change, detaching it from the original hosting activity and attaching it to a new hosting activity. Since it is the same fragment instance, anything contained inside that instance is itself retained and, therefore, is not lost when the activity is destroyed and recreated.

To see this in action, take a look at the [ConfigChange/Fragments](#) sample project.

The business logic for this demo (and for all the other demos in this chapter) is that we want to allow the user to pick a contact out of the roster of contacts found on their device or emulator. We will do that by having the user press a “Pick” button, at which time we will display an activity that will let the user pick the contact and return the result to us. Then, we will enable a “View” button, and let the user view the details of the selected contact. The key is that our selected contact needs to be retained across configuration changes — otherwise, the user will rotate the screen, and the activity will appear to forget about the chosen contact.

The activity itself just loads the dynamic fragment, following the recipe seen previously in this book:

```
package com.commonware.android.rotation.frag;

import android.os.Bundle;
import com.actionbarsherlock.app.SherlockFragmentActivity;

public class RotationFragmentDemo extends SherlockFragmentActivity {
    @Override
    public void onCreate(Bundle savedInstanceState) {
        super.onCreate(savedInstanceState);

        if
(getSupportFragmentManager().findFragmentById(android.R.id.content)==null) {
            getSupportFragmentManager().beginTransaction()
                .add(android.R.id.content,
                    new RotationFragment()).commit();
        }
    }
}
```

## RESOURCE SETS AND CONFIGURATIONS

---

The reason for checking for the fragment's existence should now be clearer. Since Android will automatically recreate (or retain) our fragments across configuration changes, we do not want to create a *second* copy of the same fragment when we already have an existing copy.

The fragment is going to use an `R.layout.main` layout resource, with two implementations. One, in `res/layout-land/`, will be used in landscape:

```
<?xml version="1.0" encoding="utf-8"?>
<LinearLayout xmlns:android="http://schemas.android.com/apk/res/android"
    android:orientation="horizontal"
    android:layout_width="fill_parent"
    android:layout_height="fill_parent"
    >
    <Button android:id="@+id/pick"
        android:layout_width="fill_parent"
        android:layout_height="fill_parent"
        android:layout_weight="1"
        android:text="@string/pick"
        android:enabled="true"
    />
    <Button android:id="@+id/view"
        android:layout_width="fill_parent"
        android:layout_height="fill_parent"
        android:layout_weight="1"
        android:text="@string/view"
        android:enabled="false"
    />
</LinearLayout>
```

The portrait edition, in `res/layout/`, is identical save for the orientation of the `LinearLayout`:

```
<?xml version="1.0" encoding="utf-8"?>
<LinearLayout xmlns:android="http://schemas.android.com/apk/res/android"
    android:orientation="vertical"
    android:layout_width="fill_parent"
    android:layout_height="fill_parent"
    >
    <Button android:id="@+id/pick"
        android:layout_width="fill_parent"
        android:layout_height="fill_parent"
        android:layout_weight="1"
        android:text="@string/pick"
        android:enabled="true"
    />
    <Button android:id="@+id/view"
        android:layout_width="fill_parent"
        android:layout_height="fill_parent"
        android:layout_weight="1"
        android:text="@string/view"
    />
```

## RESOURCE SETS AND CONFIGURATIONS

---

```
        android:enabled="false"  
    />  
</LinearLayout>
```

Here is the complete implementation of RotationFragment:

```
package com.commonware.android.rotation.frag;  
  
import android.app.Activity;  
import android.content.Intent;  
import android.net.Uri;  
import android.os.Bundle;  
import android.provider.ContactsContract;  
import android.view.LayoutInflater;  
import android.view.View;  
import android.view.ViewGroup;  
import com.actionbarsherlock.app.SherlockFragment;  
  
public class RotationFragment extends SherlockFragment implements  
    View.OnClickListener {  
    static final int PICK_REQUEST=1337;  
    Uri contact=null;  
  
    @Override  
    public View onCreateView(LayoutInflater inflater, ViewGroup parent,  
        Bundle savedInstanceState) {  
        setRetainInstance(true);  
  
        View result=inflater.inflate(R.layout.main, parent, false);  
        result.findViewById(R.id.pick).setOnClickListener(this);  
  
        View v=result.findViewById(R.id.view);  
  
        v.setOnClickListener(this);  
        v.setEnabled(contact != null);  
  
        return(result);  
    }  
  
    @Override  
    public void onActivityResult(int requestCode, int resultCode,  
        Intent data) {  
        if (requestCode == PICK_REQUEST) {  
            if (resultCode == Activity.RESULT_OK) {  
                contact=data.getData();  
                getView().findViewById(R.id.view).setEnabled(true);  
            }  
        }  
    }  
  
    @Override  
    public void onClick(View v) {
```

```
    if (v.getId() == R.id.pick) {
        pickContact(v);
    }
    else {
        viewContact(v);
    }
}

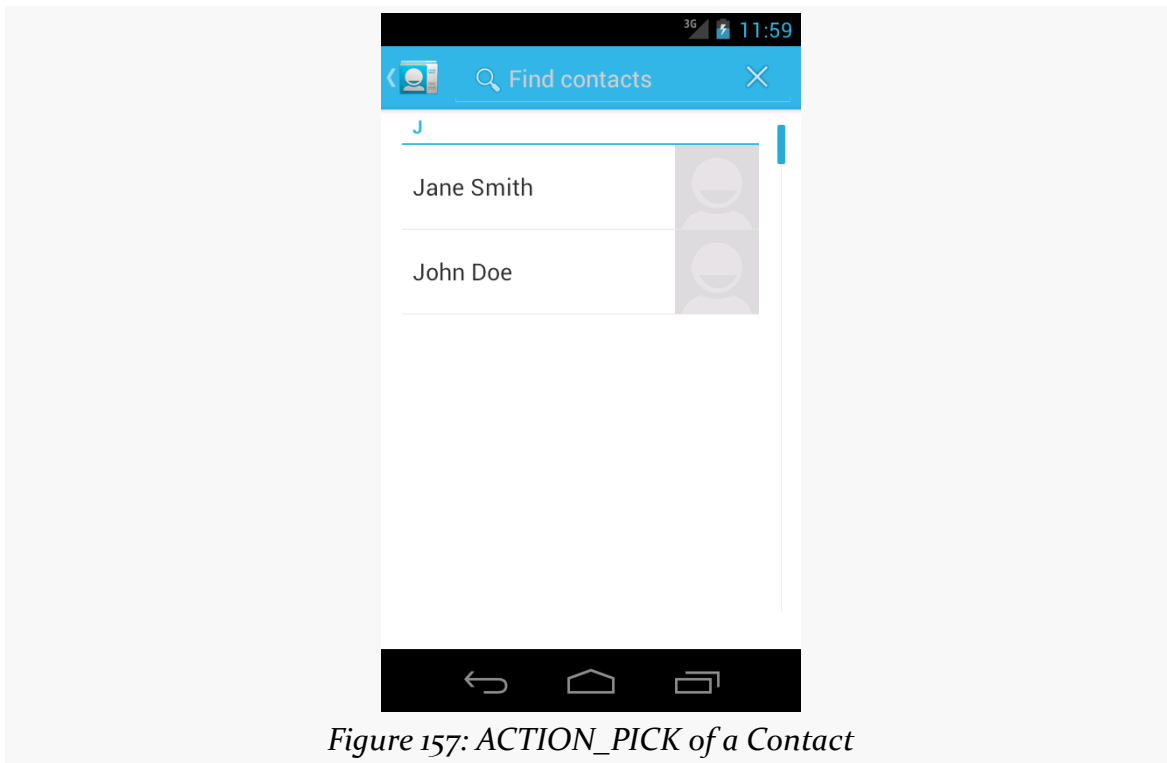
public void pickContact(View v) {
    Intent i=
        new Intent(Intent.ACTION_PICK,
            ContactsContract.Contacts.CONTENT_URI);

    startActivityForResult(i, PICK_REQUEST);
}

public void viewContact(View v) {
    startActivity(new Intent(Intent.ACTION_VIEW, contact));
}
}
```

In `onCreateView()`, we hook up the “Pick” button to a `pickContact()` method. There, we call `startActivityForResult()` with an `ACTION_PICK` Intent, indicating that we want to pick something from the `ContactsContract.Contacts.CONTENT_URI` collection of contacts. We will discuss `ContactsContract` in greater detail later in this book. For the moment, take it on faith that Android has such an `ACTION_PICK` activity, one that will display to the user the list of available contacts:





If the user picks a contact, control returns to our activity, with a call to `onActivityResult()`. `onActivityResult()` is passed:

- the unique ID we supplied to `startActivityForResult()`, to help identify this result from any others we might be receiving
- `RESULT_OK` if the user did pick a contact, or `RESULT_CANCELED` if the user abandoned the pick activity
- an `Intent` containing the result from the pick activity, which, in this case, will contain a `Uri` representing the selected contact, retrieved via `getData()`

We store that `Uri` in a data member, plus we enable the “View” button, which, when clicked, will bring up an `ACTION_VIEW` activity on the selected contact via its `Uri`:

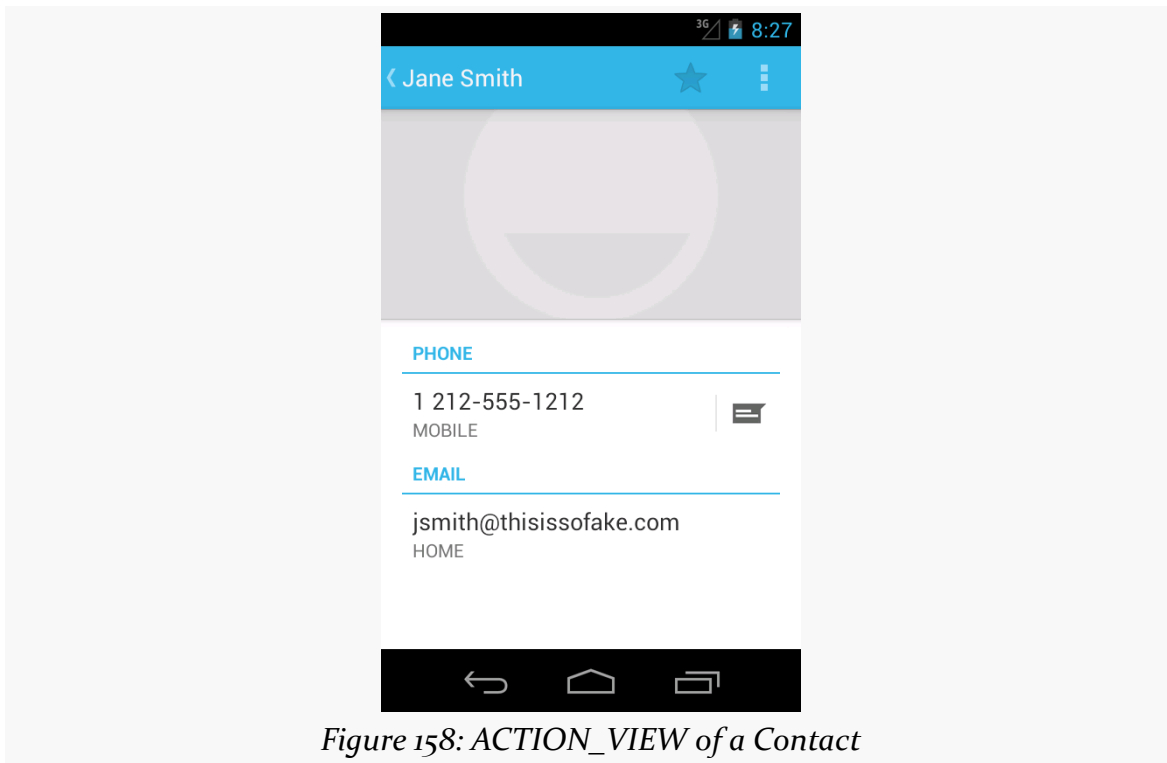


Figure 158: ACTION\_VIEW of a Contact

Up in `onCreateView()`, we called `setRetainInstance(true)`. This tells Android to keep this fragment instance across configuration changes. Hence, we can pick a contact in portrait mode, then rotate the screen (e.g., `<Ctrl>-<F11>` in the emulator on Windows or Linux), and view the contact in landscape mode. Even though the activity and the buttons were replaced as a result of the rotation, the fragment was not, and the fragment held onto the `Uri` of the selected contact.

Note that `setRetainInstance()` only works with dynamic fragments, not static fragments. Static fragments are always recreated when the activity is itself destroyed and recreated.

### Model Fragment

A variation on this theme is the “model fragment”. While fragments normally are focused on supplying portions of the UI to a user, that is not really a requirement. A model fragment is one that simply uses `setRetainInstance(true)` to ensure that it sticks around as configurations change. This fragment then holds onto any model data that its host activity needs, so as that activity gets destroyed and recreated, the model data stick around in the model fragment.

This is particularly useful for data that might not otherwise have a fragment home. For example, imagine an activity whose UI consists entirely of a `ViewPager`, (like the tutorial app). Even though that `ViewPager` might hold fragments, there will be many pages in most pagers. It may be simpler to add a separate, UI-less model fragment and have it hold the activity's data model for the `ViewPager`. This allows the activity to still be destroyed and recreated, and even allows the `ViewPager` to be destroyed and recreated, while still retaining the already-loaded data.

### Add to the Bundle

However, you may not be using fragments, in which case `setRetainInstance(true)` will not be available to you. In that case, you will have to turn to some alternative approaches.

The best of those is to use `onSaveInstanceState()` and `onRestoreInstanceState()`.

You can override `onSaveInstanceState()` in your activity. It is passed a `Bundle`, into which you can store data that should be maintained across the configuration change. The catch is that while `Bundle` looks a bit like it is a `HashMap`, it actually cannot hold arbitrary data types, which limits the sort of information you can retain via `onSaveInstanceState()`. `onSaveInstanceState()` is called around the time of `onPause()` and `onStop()`.

The widget state maintained automatically by Android is via the built-in implementation of `onSaveInstanceState()`. If you override it yourself, typically you will want to chain to the superclass to get this inherited behavior, in addition to putting things into the `Bundle` yourself.

That `Bundle` is passed back to you in two places:

- `onCreate()`
- `onRestoreInstanceState()`

Since `onCreate()` is called in many cases other than due to a configuration change, frequently the passed-in `Bundle` is null. `onRestoreInstanceState()`, on the other hand, is only called when there is a `Bundle` to be used.

To see how this works, take a look at the [ConfigChange/Bundle](#) sample project.

Here, `RotationBundleDemo` is an activity with all the same core business logic as was in our fragment in the preceding demo. Since the activity will be destroyed and

## RESOURCE SETS AND CONFIGURATIONS

---

recreated on a configuration change, we override `onSaveInstanceState()` and `onRestoreInstanceState()` to retain our contact, if one was selected prior to the configuration change:

```
@Override
protected void onSaveInstanceState(Bundle outState) {
    super.onSaveInstanceState(outState);

    if (contact != null) {
        outState.putString("contact", contact.toString());
    }
}

@Override
protected void onRestoreInstanceState(Bundle state) {
    String contactUri=state.getString("contact");

    if (contactUri != null) {
        contact=Uri.parse(contactUri);
        viewButton.setEnabled(contact != null);
    }
}
```

The big benefit of this approach is that `onSaveInstanceState()` is used for another scenario, beyond configuration changes.

Suppose, while the user is using one of your activities, a text message comes in. The user taps on the notification and goes into the text messaging client, while your activity is paused and stopped. While texting, the other party sends over a URL in one of the messages. The user taps on that URL to open up a Web browser. And, right at that moment, a phone call comes in.

Android may not have enough free RAM to handle launching the browser and the phone applications, because too many things are happening at once. Hence, Android may terminate *your* process, to free up RAM. Yet, it is entirely possible that the user could return to your activity via the BACK button.

If the user does return to your activity via BACK, Android will fork a fresh process for your application, will create a new instance of your activity, and will supply to that activity the `Bundle` from `onSaveInstanceState()` of the old activity. This way, you can help retain context from what the user had been doing, despite your entire process having been gone for a while.

### Retain Other Objects

The problem with `onSaveInstanceState()` is that you are limited to a `Bundle`. That's because this callback is also used in cases where your whole process might be terminated (e.g., low memory), so the data to be saved has to be something that can be serialized and has no dependencies upon your running process.

For some activities, that limitation is not a problem. For others, though, it is more annoying. Take an online chat, for example. You have no means of storing a socket in a `Bundle`, so by default, you will have to drop your connection to the chat server and re-establish it. That not only may be a performance hit, but it might also affect the chat itself, such as you appearing in the chat logs as disconnecting and reconnecting.

One way to get past this is to use `onRetainNonConfigurationInstance()` instead of `onSaveInstanceState()` for “light” changes like a rotation. Your activity's `onRetainNonConfigurationInstance()` callback can return an `Object`, which you can retrieve later via `getLastNonConfigurationInstance()`. The `Object` can be just about anything you want — typically, it will be some kind of “context” object holding activity state, such as running threads, open sockets, and the like. Your activity's `onCreate()` can call `getLastNonConfigurationInstance()` – if you get a non-null response, you now have your sockets and threads and whatnot.

The biggest limitation is that you do not want to put in the saved context anything that might reference a resource that will get swapped out, such as a `Drawable` loaded from a resource.

The second-biggest limitation is that you do not want to put in the saved context anything that has a reference back to your original activity instance. Otherwise, the new activity will hold an indirect reference back to the old activity, and the old activity will not be able to be garbage-collected.

The general strategy, therefore, is to use `onSaveInstanceState()` for everything that it can handle, since it covers other scenarios beyond configuration changes. Use `onRetainNonConfigurationInstance()` for everything else.

To see this approach, take a look at the [ConfigChange/Retain](#) sample project.

This is the same as the previous sample, except that `RotationRetainDemo` implements `onRetainNonConfigurationInstance()`, returning the `Uri` that represents our selected contact:

```
@Override
public Object onRetainNonConfigurationInstance() {
    return(contact);
}
```

In `onCreate()`, we call `getLastNonConfigurationInstance()`. This will either be `null` or our `Uri` from a preceding instance. In either case, we store the value in `contact` and use it:

```
@Override
public void onCreate(Bundle savedInstanceState) {
    super.onCreate(savedInstanceState);
    setContentView(R.layout.main);

    viewButton=(Button)findViewById(R.id.view);
    contact=(Uri)getLastNonConfigurationInstance();
    viewButton.setEnabled(contact != null);
}
```

### DIY

In a few cases, even `onRetainNonConfigurationInstance()` is insufficient, because transferring and re-applying the state would be too complex or too slow. Or, in some cases, the hardware will get in the way, such as when trying to use the Camera for taking pictures — a concept we will cover later in this book.

If you are completely desperate, you can tell Android to *not* destroy and recreate the activity on a configuration change... though this has its own set of consequences. To do this:

- Put an `android:configChanges` entry in your `AndroidManifest.xml` file, listing the configuration changes you want to handle yourself versus allowing Android to handle for you
- Implement `onConfigurationChanged()` in your Activity, which will be called when one of the configuration changes you listed in `android:configChanges` occurs

Now, for any configuration change you want, you can bypass the whole activity-destruction process and simply get a callback letting you know of the change.

For example, take a look at the [ConfigChange/DIY](#) sample project.

## RESOURCE SETS AND CONFIGURATIONS

---

In `AndroidManifest.xml`, we add the `android:configChanges` attribute to the `<activity>` element, indicating that we want to handle several configuration changes ourselves:

```
<activity
    android:name="RotationDIYDemo"
    android:configChanges="keyboardHidden|orientation|screenSize|smallestScreenSize"
    android:label="@string/app_name">
    <intent-filter>
        <action android:name="android.intent.action.MAIN"/>

        <category android:name="android.intent.category.LAUNCHER"/>
    </intent-filter>
</activity>
```

Many recipes for this will have you handle `orientation` and `keyboardHidden`. However, nowadays, you need to also handle `screenSize` and `smallestScreenSize`, if you have your `android:targetSdkVersion` set to 13 or higher. Note that this will require your build target to be set to 13 or higher.

Hence, for those particular configuration changes, Android will not destroy and recreate the activity, but instead will call `onConfigurationChanged()`. In the `RotationDIYDemo` implementation, this simply toggles the orientation of the `LinearLayout` to match the orientation of the device:

```
@Override
public void onConfigurationChanged(Configuration newConfig) {
    super.onConfigurationChanged(newConfig);

    LinearLayout container=(LinearLayout)findViewById(R.id.container);

    if (newConfig.orientation == Configuration.ORIENTATION_LANDSCAPE) {
        container.setOrientation(LinearLayout.HORIZONTAL);
    }
    else {
        container.setOrientation(LinearLayout.VERTICAL);
    }
}
```

Since the activity is not destroyed during a configuration change, we do not need to worry at all about the `Uri` of the selected contact — it is not going anywhere.

The problem with this implementation is twofold:

1. We are not handling all possible configuration changes. If the user, say, puts the device into a car dock, Android will destroy and recreate our activity, and we will lose our selected contact.
2. We might forget some resource that needs to be changed due to a configuration change. For example, if we start translating the strings used by the layouts, and we include `locale` in `android:configChanges`, we not only need to update the `LinearLayout` but also the captions of the `Button` widgets, since Android will not do that for us automatically.

It is these two problems that are why Google does not recommend the use of this technique unless absolutely necessary.

## Blocking Rotations

No doubt that you have seen some Android applications that simply ignore any attempt to rotate the screen. Many games work this way, operating purely in landscape mode, regardless of how the device is positioned.

To do this, add `android:screenOrientation="landscape"`, or possibly `android:screenOrientation="portrait"`, to your manifest.

Ideally, you choose landscape, as some devices (e.g., Google TV) can only *be* landscape.

Also note that Android *still* treats this as a configuration change, despite the fact that there is no visible change to the user. Hence, you still need to use one of the aforementioned techniques to handle this configuration change, along with any others (e.g., dock events, locale changes).





# Dealing with Threads

---

Users like snappy applications. Users do not like applications that feel sluggish.

The way to help your application feel snappy is to use the standard threading capabilities built into Android. This chapter will go through the issues involved with thread management in Android and will walk you through some of the options for keeping the user interface crisp and responsive.

## The Main Application Thread

When you call `setText()` on a `TextView`, you probably think that the screen is updated with the text you supply, right then and there.

You would be mistaken.

Rather, everything that modifies the widget-based UI goes through a message queue. Calls to `setText()` do not update the screen — they just place a message on a queue telling the operating system to update the screen. The operating system pops these messages off of this queue and does what the messages require.

The queue is processed by one thread, variously called the “main application thread” and the “UI thread”. So long as that thread can keep processing messages, the screen will update, user input will be handled, and so on.

However, the main application thread is also used for nearly all callbacks into your activity. Your `onCreate()`, `onClick()`, `onListItemClick()`, and similar methods are all called on the main application thread. While your code is executing in these methods, Android is not processing messages on the queue, and so the screen does not update, user input is not handled, and so on.

This, of course, is bad. So bad, that if you take more than a few seconds to do work on the main application thread, Android may display the dreaded “Application Not Responding” dialog (ANR for short), and your activity may be killed off.

Hence, you want to make sure that all of your work on the main application thread happens quickly. This means that anything slow should be done in a background thread, so as not to tie up the main application thread. This includes things like:

1. Internet access, such as sending data to a Web service or downloading an image
2. Significant file operations, since flash storage can be remarkably slow at times
3. Any sort of complex calculations

Fortunately, Android supports threads using the standard `Thread` class from Java, plus all of the wrappers and control structures you would expect, such as the `java.util.concurrent` class package.

However, there is one big limitation: you cannot modify the UI from a background thread. You can only modify the UI from the main application thread. If you call `setText()` on a `TextView` from a background thread, your application will crash, with an exception indicating that you are trying to modify the UI from a “non-UI thread” (i.e., a thread other than the main application thread).

This is a pain.

## Getting to the Background

Hence, you need to get long-running work moved into background threads, but those threads need to do something to arrange to update the UI using the main application thread.

There are various facilities in Android for helping with this.

Some are high-level frameworks for addressing this issue for major functional areas. The pre-eminent example of this is the `Loader` framework for retrieving information from databases, and we will examine this [in a later chapter](#).

Sometimes, there are asynchronous options built into other Android operations. For example, when we discuss `SharedPreferences` [in a later chapter](#), we will see that we can persist changes to those preferences synchronously or asynchronously.

And, there are a handful of low-level solutions for solving this problem, ones that you can apply for your own custom business logic.

## Asynching Feeling

One popular approach for handling this threading problem is to use `AsyncTask`. With `AsyncTask`, Android will handle all of the chores of coordinating separate work done on a background thread versus on the UI thread. Moreover, Android itself allocates and removes that background thread. And, it maintains a small work queue, further accentuating the “fire and forget” feel to `AsyncTask`.

### The Theory

There is a saying, popular in marketing circles: “When a man buys a 1/4” drill bit at a hardware store, he does not want a 1/4” drill bit — he wants 1/4” holes”. Hardware stores cannot sell holes, so they sell the next-best thing: devices (drills and drill bits) that make creating holes easy.

Similarly, Android developers who have struggled with background thread management do not strictly want background threads — they want work to be done off the UI thread, so users are not stuck waiting and activities do not get the dreaded “application not responding” (ANR) error. And while Android cannot magically cause work to not consume UI thread time, Android can offer things that make such background operations easier and more transparent. `AsyncTask` is one such example.

To use `AsyncTask`, you must:

1. Create a subclass of `AsyncTask`, commonly as a private inner class of something that uses the task (e.g., an activity)
2. Override one or more `AsyncTask` methods to accomplish the background work, plus whatever work associated with the task that needs to be done on the UI thread (e.g., update progress)
3. When needed, create an instance of the `AsyncTask` subclass and call `execute()` to have it begin doing its work

What you do *not* have to do is:

1. Create your own background thread
2. Terminate that background thread at an appropriate time
3. Call all sorts of methods to arrange for bits of processing to be done on the UI thread

### **AsyncTask, Generics, and Varargs**

Creating a subclass of `AsyncTask` is not quite as easy as, say, implementing the `Runnable` interface. `AsyncTask` uses generics, and so you need to specify three data types:

1. The type of information that is needed to process the task (e.g., URLs to download)
2. The type of information that is passed within the task to indicate progress
3. The type of information that is passed when the task is completed to the post-task code

What makes this all the more confusing is that the first two data types are actually used as varargs, meaning that an array of these types is used within your `AsyncTask` subclass.

This should become clearer as we work our way towards an example.

### **The Stages of AsyncTask**

There are four methods you can override in `AsyncTask` to accomplish your ends.

The one you must override, for the task class to be useful, is `doInBackground()`. This will be called by `AsyncTask` on a background thread. It can run as long as it needs to in order to accomplish whatever work needs to be done for this specific task. Note, though, that tasks are meant to be finite – using `AsyncTask` for an infinite loop is not recommended.

The `doInBackground()` method will receive, as parameters, a varargs array of the first of the three data types listed above — the data needed to process the task. So, if your task's mission is to download a collection of URLs, `doInBackground()` will receive those URLs to process.

The `doInBackground()` method must return a value of the third data type listed above — the result of the background work.

You may wish to override `onPreExecute()`. This method is called, from the UI thread, before the background thread executes `doInBackground()`. Here, you might initialize a `ProgressBar` or otherwise indicate that background work is commencing.

Also, you may wish to override `onPostExecute()`. This method is called, from the UI thread, after `doInBackground()` completes. It receives, as a parameter, the value returned by `doInBackground()` (e.g., success or failure flag). Here, you might dismiss the `ProgressBar` and make use of the work done in the background, such as updating the contents of a list.

In addition, you may wish to override `onProgressUpdate()`. If `doInBackground()` calls the task's `publishProgress()` method, the object(s) passed to that method are provided to `onProgressUpdate()`, but in the UI thread. That way, `onProgressUpdate()` can alert the user as to the progress that has been made on the background work. The `onProgressUpdate()` method will receive a varargs of the second data type from the above list — the data published by `doInBackground()` via `publishProgress()`.

### A Quick Note About Toasts

In the sample app that follows, we use a `Toast` to let the user know some work has been completed.

A `Toast` is a transient message, meaning that it displays and disappears on its own without user interaction. Moreover, it does not take focus away from the currently-active `Activity`, so if the user is busy writing the next *Great Programming Guide*, they will not have keystrokes be “eaten” by the message.

Since a `Toast` is transient, you have no way of knowing if the user even notices it. You get no acknowledgment from them, nor does the message stick around for a long time to pester the user. Hence, the `Toast` is mostly for advisory messages, such as indicating a long-running background task is completed, the battery has dropped to a low-but-not-too-low level, etc.

Making a `Toast` is fairly easy. The `Toast` class offers a static `makeText()` method that accepts a `String` (or string resource ID) and returns a `Toast` instance. The `makeText()` method also needs the `Activity` (or other `Context`) plus a duration. The duration is expressed in the form of the `LENGTH_SHORT` or `LENGTH_LONG` constants to

indicate, on a relative basis, how long the message should remain visible. Once your Toast is configured, call its `show()` method, and the message will be displayed.

### A Sample Task

As mentioned earlier, implementing an `AsyncTask` is not quite as easy as implementing a `Runnable`. However, once you get past the generics and varargs, it is not too bad.

To see an `AsyncTask` in action, this section will examine the [Threads/AsyncTask](#) sample project.

### The Fragment and its `AsyncTask`

We have a `SherlockListFragment`, named `AsyncDemoFragment`:

```
package com.commonware.android.async;

import java.util.ArrayList;
import android.os.AsyncTask;
import android.os.Bundle;
import android.os.SystemClock;
import android.widget.AdapterView;
import android.widget.Toast;
import com.actionbarsherlock.app.SherlockListFragment;

public class AsyncDemoFragment extends SherlockListFragment {
    private static final String[] items= { "lorem", "ipsum", "dolor",
        "sit", "amet", "consectetuer", "adipiscing", "elit", "morbi",
        "vel", "ligula", "vitae", "arcu", "aliquet", "mollis", "etiam",
        "vel", "erat", "placerat", "ante", "porttitor", "sodales",
        "pellentesque", "augue", "purus" };
    private ArrayList<String> model=null;
    private ArrayAdapter<String> adapter=null;

    @Override
    public void onActivityCreated(Bundle savedInstanceState) {
        super.onActivityCreated(savedInstanceState);

        setRetainInstance(true);

        if (model == null) {
            model=new ArrayList<String>();
            new AddStringTask().execute();
        }

        adapter=
            new ArrayAdapter<String>(getActivity(),
                android.R.layout.simple_list_item_1,
```

```
        model);

        listView.setScrollbarFadingEnabled(false);
        listView.setAdapter(adapter);
    }

    class AddStringTask extends AsyncTask<Void, String, Void> {
        @Override
        protected Void doInBackground(Void... unused) {
            for (String item : items) {
                publishProgress(item);
                SystemClock.sleep(400);
            }

            return(null);
        }

        @Override
        protected void onProgressUpdate(String... item) {
            adapter.add(item[0]);
        }

        @Override
        protected void onPostExecute(Void unused) {
            Toast.makeText(getActivity(), R.string.done, Toast.LENGTH_SHORT)
                .show();
        }
    }
}
```

This is another variation on the *lorem ipsum* list of words, used frequently throughout this book. This time, rather than simply hand the list of words to an `ArrayAdapter`, we simulate having to work to create these words in the background using `AddStringTask`, our `AsyncTask` implementation.

In `onActivityCreated()`, we call `setRetainInstance(true)`, so Android will retain this fragment across configuration changes, such as a screen rotation. We then examine a `model` data member. If it is `null`, we know that this is the first time our fragment has been used, so we initialize it to be an `ArrayList` of `String` values, plus kick off our `AsyncTask` (the `AddStringTask` inner class, described below). We then set up the adapter and attach it to the `ListView`, also preventing the `ListView` scrollbars from fading away as is their norm.

In the declaration of `AddStringTask`, we use the generics to set up the specific types of data we are going to leverage. Specifically:

1. We do not need any configuration information in this case, so our first type is `Void`



## DEALING WITH THREADS

---

2. We want to pass each string “generated” by our background task to `onProgressUpdate()`, so we can add it to our list, so our second type is `String`
3. We do not have any results, strictly speaking (beyond the updates), so our third type is `Void`

The `doInBackground()` method is invoked in a background thread. Hence, we can take as long as we like. In a production application, we would be, perhaps, iterating over a list of URLs and downloading each. Here, we iterate over our static list of *lorem ipsum* words, call `publishProgress()` for each, and then sleep 400 milliseconds to simulate real work being done.

Since we elected to have no configuration information, we should not need parameters to `doInBackground()`. However, the contract with `AsyncTask` says we need to accept a varargs of the first data type, which is why our method parameter is `Void...`

Since we elected to have no results, we should not need to return anything. Again, though, the contract with `AsyncTask` says we have to return an object of the third data type. Since that data type is `Void`, our returned object is `null`.

The `onProgressUpdate()` method is called on the UI thread, and we want to do something to let the user know we are progressing on loading up these strings. In this case, we simply add the string to the `ArrayAdapter`, so it gets appended to the end of the list.

The `onProgressUpdate()` method receives a `String... varargs` because that is the second data type in our class declaration. Since we are only passing one string per call to `publishProgress()`, we only need to examine the first entry in the varargs array.

The `onPostExecute()` method is called on the UI thread, and we want to do something to indicate that the background work is complete. In a real system, there may be some `ProgressBar` to dismiss or some animation to stop. Here, we simply raise a `Toast`.

Since we elected to have no results, we should not need any parameters. The contract with `AsyncTask` says we have to accept a single value of the third data type. Since that data type is `Void`, our method parameter is `Void` unused.

---

## DEALING WITH THREADS

---

To use `AddStringTask`, we simply create an instance and call `execute()` on it. That starts the chain of events eventually leading to the background thread doing its work.

If `AddStringsTask` required configuration parameters, we would have not used `Void` as our first data type, and the constructor would accept zero or more parameters of the defined type. Those values would eventually be passed to `doInBackground()`.

### The Activity and the Results

`AsyncDemo` is a `SherlockFragmentActivity` with the standard recipe for kicking off an instance of a dynamic fragment:

```
package com.commonware.android.async;

import android.os.Bundle;
import com.actionbarsherlock.app.SherlockFragmentActivity;

public class AsyncDemo extends SherlockFragmentActivity {
    @Override
    public void onCreate(Bundle savedInstanceState) {
        super.onCreate(savedInstanceState);

        if
(getSupportFragmentManager().findFragmentById(android.R.id.content)==null) {
            getSupportFragmentManager().beginTransaction()
                .add(android.R.id.content,
                    new AsyncDemoFragment()).commit();
        }
    }
}
```

If you build, install, and run this project, you will see the list being populated in “real time” over a few seconds, followed by a `Toast` indicating completion.

### Threads and Configuration Changes

One problem with the default destroy-and-create cycle that activities go through on a configuration change comes from background threads. If the activity has started some background work — through an `AsyncTask`, for example — and then the activity is destroyed and re-created, somehow the `AsyncTask` needs to know about this. Otherwise, the `AsyncTask` might well send updates and final results to the *old* activity, with the new activity none the wiser. In fact, the new activity might start up the background work *again*, wasting resources.

That is why, in the sample above, we are retaining the fragment instance. The fragment instance holds onto its data model (in this case, the `ArrayList` of nonsense words) and knows not to kick off a new `AsyncTask` just because the configuration changed. Moreover, we retain that data model, so the new `ListView` created due to the configuration change can work with a new adapter backed by the old data model, so we do not lose our existing set of nonsense words.

We also have to be very careful not to try referring to the activity (via `getActivity()` on the fragment) from our background thread (`doInBackground()`). Because, suppose that during the middle of the `doInBackground()` processing, the user rotates the screen. The activity we work with will change on the fly, on the main application thread, independently of the work being done in the background. The activity returned by `getActivity()` may not be in a useful state for us while this configuration change is going on.

However, it is safe for us to use `getActivity()` from `onPostExecute()`, and even from `onProgressUpdate()`.

Why?

Most callback methods in Android are driven by messages on the message queue being processed by the main application thread. Normally, this queue is being processed whenever the main application thread is not otherwise busy, such as running our code.

However, when a configuration change occurs, like a screen rotation, that no longer holds true.

Android guarantees that, while on the main application thread, `getActivity()` will return a valid `Activity`. Moreover, once the configuration change starts, no messages on the message queue will be processed until after `onCreate()` of the hosting activity (and `onActivityCreated()` of the fragment) have completed their work.

### Where Not to Use `AsyncTask`

`AsyncTask`, particularly in conjunction with a dynamic fragment, is a wonderful solution for most needs for a background thread.

The key word in that sentence is “most”.

AsyncTask manages a thread pool, from which it pulls the threads to be used by task instances. Thread pools assume that they will get their threads back after a reasonable period of time. Hence, AsyncTask is a poor choice when you do not know how long you need the thread (e.g., thread listening on a socket for a chat client, where you need the thread until the user exits the client).

### About the AsyncTask Thread Pool

Moreover, the thread pool that AsyncTask manages has varied in size.

In Android 1.5, it was a single thread.

In Android 1.6, it was expanded to support many parallel threads, probably more than you will ever need.

In Android 4.0, it has shrunk back to a single thread, if your `android:targetSdkVersion` is set to 13 or higher. This was to address concerns about:

- Forking too many threads and starving the CPU
- Developers thinking that there is an ordering dependency between forked tasks, when with the parallel execution there is none

If you wish, starting with API Level 11, you can supply your own Executor (from the `java.util.concurrent` package) that has whatever thread pool you wish, so you can manage this more yourself. In addition to the serialized, one-at-a-time Executor, there is a built-in Executor that implements the old thread pool, that you can use rather than rolling your own. We will examine this more in a later chapter on dealing with backwards-compatibility issues.

### Alternatives to AsyncTask

There are other ways of handling background threads without using AsyncTask:

- You can employ a Handler, which has a `handleMessage()` method that will process Message objects, dispatched from a background thread, on the main application thread
- You can supply a Runnable to be executed on the main application thread to `post()` on any View, or to `runOnUiThread()` on Activity

## DEALING WITH THREADS

---

- You can supply a Runnable, plus a delay period in milliseconds, to `postDelayed()` on any View, to run the Runnable on the main application thread after *at least* that number of millisecond has elapsed

Of these, the Runnable options are the easiest to use.

These can also be used to allow the main application thread to postpone work, to be done *later* on the main application thread. For example, you can use `postDelayed()` to set up a lightweight polling “loop” within an activity, without needing the overhead of an extra thread, such as the one created by `Timer` and `TimerTask`. To see how this works, let’s take a peek at the [Threads/PostDelayed](#) sample project.

This project contains a single activity, named `PostDelayedDemo`:

```
package com.commonware.android.post;

import android.app.Activity;
import android.os.Bundle;
import android.view.View;
import android.widget.Toast;

public class PostDelayedDemo extends Activity implements Runnable {
    private static final int PERIOD=5000;
    private View root=null;

    @Override
    protected void onCreate(Bundle savedInstanceState) {
        super.onCreate(savedInstanceState);
        setContentView(R.layout.main);
        root=findViewById(android.R.id.content);
    }

    @Override
    public void onResume() {
        super.onResume();

        run();
    }

    @Override
    public void onPause() {
        root.removeCallbacks(this);

        super.onPause();
    }

    @Override
    public void run() {
        Toast.makeText(PostDelayedDemo.this, "Who-hoo!", Toast.LENGTH_SHORT)
            .show();
    }
}
```

```
    root.postDelayed(this, PERIOD);  
  }  
}
```

We want to display a Toast every five seconds. To do this, in `onCreate()`, we get our hands on the container for an activity's UI, known as `android.R.id.content`, via `findViewById()`. Then, in `onResume()`, we call a `run()` method on our activity, which displays the Toast and calls `postDelayed()` to schedule *itself* (as an implementation of `Runnable`) to be run again in `PERIOD` milliseconds. While our activity is in the foreground, the Toast will appear every `PERIOD` milliseconds as a result. Once something else comes to the foreground — such as by the user pressing `BACK` — our `onPause()` method is called, where we call `removeCallbacks()` to “undo” the `postDelayed()` call.

## And Now, The Caveats

Background threads, while eminently possible using `AsyncTask` and kin, are not all happiness and warm puppies. Background threads not only add complexity, but they have real-world costs in terms of available memory, CPU, and battery life.

To that end, there is a wide range of scenarios you need to account for with your background thread, including:

1. The possibility that users will interact with your activity's UI while the background thread is chugging along. If the work that the background thread is doing is altered or invalidated by the user input, you will need to communicate this to the background thread. Android includes many classes in the `java.util.concurrent` package that will help you communicate safely with your background thread.
2. The possibility that the activity will be killed off while background work is going on. For example, after starting your activity, the user might have a call come in, followed by a text message, followed by a need to look up a contact... all of which might be sufficient to kick your activity out of memory.
3. The possibility that your user will get irritated if you chew up a lot of CPU time and battery life without giving any payback. Tactically, this means using `ProgressBar` or other means of letting the user know that something is happening. Strategically, this means you still need to be efficient at what you do — background threads are no panacea for sluggish or pointless code.
4. The possibility that you will encounter an error during background processing. For example, if you are gathering information off the Internet, the device might lose connectivity. Alerting the user of the problem via a

## DEALING WITH THREADS

---

Notification and shutting down the background thread may be your best option.

# Requesting Permissions

---

In the late 1990's, a wave of viruses spread through the Internet, delivered via email, using contact information culled from Microsoft Outlook. A virus would simply email copies of itself to each of the Outlook contacts that had an email address. This was possible because, at the time, Outlook did not take any steps to protect data from programs using the Outlook API, since that API was designed for ordinary developers, not virus authors.

Nowadays, many applications that hold onto contact data secure that data by requiring that a user explicitly grant rights for other programs to access the contact information. Those rights could be granted on a case-by-case basis or all at once at install time.

Android is no different, in that it requires permissions for applications to read or write contact data. Android's permission system is useful well beyond contact data, and for content providers and services beyond those supplied by the Android framework.

You, as an Android developer, will frequently need to ensure your applications have the appropriate permissions to do what you want to do with other applications' data. This chapter covers this topic.

You may also elect to require permissions for other applications to use your data or services, if you make those available to other Android components. This will be discussed [later in this book](#).



## Mother, May I?

Requesting the use of other applications' data or services requires the `uses-permission` element to be added to your `AndroidManifest.xml` file. Your manifest may have zero or more `uses-permission` elements, all as direct children of the root manifest element.

The `uses-permission` element takes a single attribute, `android:name`, which is the name of the permission your application requires:

```
<uses-permission android:name="android.permission.ACCESS_LOCATION" />
```

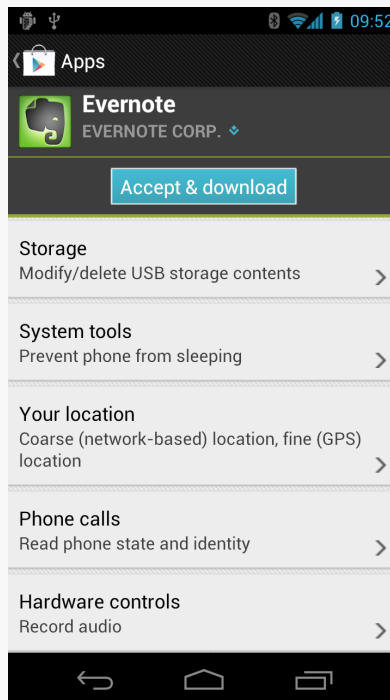
The stock system permissions all begin with `android.permission` and are listed in the Android SDK documentation for `Manifest.permission`. Third-party applications may have their own permissions, which hopefully they have documented for you. Here are some of the permissions we will see in this book:

1. `INTERNET`, if your application wishes to access the Internet through any means, from raw Java sockets through the `WebView` widget
2. `WRITE_EXTERNAL_STORAGE`, for writing data to external storage
3. `ACCESS_COARSE_LOCATION` and `ACCESS_FINE_LOCATION`, for determining where the device is
4. `CALL_PHONE`, to allow the application to place phone calls directly, without user intervention

Permissions are confirmed at the time the application is installed — the user will be prompted to confirm it is OK for your application to do what the permission calls for.

## REQUESTING PERMISSIONS

---



*Figure 159: Permission Confirmation Screen, on Android 4.0.3*

Hence, it is important for you to ask for as few permissions as possible and to justify those you ask for, so users do not elect to skip installing your application because you ask for too many unnecessary permissions. Note that users are not asked to confirm permissions when loading an application via USB, such as during development.

If you do not have the desired permission and try to do something that needs it, you should get a `SecurityException` informing you of the missing permission. Note that you will only fail on a permission check if you forgot to ask for the permission — it is impossible for your application to be running and *not* have been granted your requested permissions.

## New Permissions in Old Applications

Sometimes, Android introduces new permissions that govern behavior that formerly did not require permissions. `WRITE_EXTERNAL_STORAGE` is one example – originally, applications could write to external storage without any permission at all. Android 1.6 introduced `WRITE_EXTERNAL_STORAGE`, required before you can write to external storage. However, applications that were written before Android 1.6 could not

possibly request that permission, since it did not exist at the time. Breaking those applications would seem to be a harsh price for progress.

What Android does is “grandfather” in certain permissions for applications supporting earlier SDK versions.

In particular, if you have `<uses-sdk android:minSdkVersion="3">` in your manifest, saying that you support Android 1.5, your application will automatically request `WRITE_EXTERNAL_STORAGE` and `READ_PHONE_STATE`, even if you do not explicitly request those permissions. People installing your application on an Android 1.5 device will see these requests.

Eventually, when you drop support for the older version (e.g., switch to `<uses-sdk android:minSdkVersion="4">`), Android will no longer automatically request those permissions. Hence, if your code really *does* need those permissions, you will need to ask for them yourself.

## Permissions: Up Front Or Not At All

The permission system in Android is not especially flexible. Notably, you have to ask for all permissions you might ever need up front, and the user has to agree to all of them or abandon the installation of your app.

This means:

1. You cannot create optional permissions, ones the user could say “no, thanks” to, that your application could react to dynamically
2. You cannot request new permissions after installation, so even if a permission is only needed for some lightly-used feature, you have to ask for it anyway

Hence, it is important as you come up with the feature list for your app that you keep permissions in mind. Every additional permission that your request is a filter that will cost you some portion of your prospective audience. Certain combinations — such as `INTERNET` and `READ_CONTACTS` — will have a stronger effect, as users fear what the combination can do. You will need to decide for yourself if the additional users you will get from having the feature will be worth the cost of requiring the permissions the feature needs to operate.

## Signature Permissions

Some permissions listed in the SDK you can request but will not get. These permissions, such as BRICK, require your application to be signed by the same signing key as is used to sign the firmware. We will discuss these signing keys and how they work [in a later chapter](#).

Some permissions, like REBOOT, require that your application either be signed with the firmware's signing key *or* that your application be pre-installed on the firmware.

Unfortunately, the Android developer documentation does not tell you the requirements for any given permission. To find out, you will need to examine [the platform's AndroidManifest.xml file](#) and find your permission in there. For example, here is one edition's definition of the BRICK and REBOOT permissions:

```
<!-- Required to be able to disable the device (very dangerous!). -->
<permission android:name="android.permission.BRICK"
    android:label="@string/permlab_brick"
    android:description="@string/permdesc_brick"
    android:protectionLevel="signature" />

<!-- Required to be able to reboot the device. -->
<permission android:name="android.permission.REBOOT"
    android:label="@string/permlab_reboot"
    android:description="@string/permdesc_reboot"
    android:protectionLevel="signatureOrSystem" />
```

The BRICK permission has an android:protectionLevel of signature, meaning the app requesting the permission must have the same signing key as does the firmware. Instead, the REBOOT permission has signatureOrSystem, meaning that the app could just be installed as part of the firmware to hold this permission.

## Requiring Permissions

The XML elements shown from Android's own manifest are <permission> elements. These define new permissions to the system.

You can use <permission> elements to define your own custom permissions for use with your own apps. This would be important if you are planning on allowing third-party applications to integrate with yours and possibly retrieve data that you are storing. The user probably should “get a vote” on whether that data sharing is allowed. To do that, you could define a permission and declare that one or more of

## REQUESTING PERMISSIONS

---

your components (e.g., activities) are protected by that permission. Only third parties that request the permission via `<uses-permission>` will be able to use those components.

We will get into this scenario in greater detail [in a later chapter](#).

# Assets, Files, and Data Parsing

---

Android offers a few structured ways to store data, notably [SharedPreferences](#) and [local SQLite databases](#). And, of course, you are welcome to store your data “in the cloud” by using an [Internet-based service](#). We will get to all of those topics shortly.

Beyond that, though, Android allows you to work with plain old ordinary files, either ones baked into your app (“assets”) or ones on so-called internal or external storage.

To make those files work — and to consume data off of the Internet — you will likely need to employ a parser. Android ships with several choices for XML and JSON parsing, in addition to [third-party libraries](#) you can attempt to use.

This chapter focuses on assets, files, and parsers.

## Packaging Files with Your App

Let’s suppose you have some static data you want to ship with the application, such as a list of words for a spell-checker. Somehow, you need to bundle that data with the application, in a way you can get at it from Java code later on, or possibly in a way you can pass to another component (e.g., `WebView` for bundled HTML files).

There are three main options here: raw resources, XML resources, and assets.

### Raw Resources

One way to deploy a file like a spell-check catalog is to put the file in the `res/raw` directory, so it gets put in the Android application `.apk` file as part of the packaging process as a raw resource.

To access this file, you need to get yourself a `Resources` object. From an activity, that is as simple as calling `getResources()`. A `Resources` object offers `openRawResource()` to get an `InputStream` on the file you specify. Rather than a path, `openRawResource()` expects an integer identifier for the file as packaged. This works just like accessing widgets via `findViewById()` – if you put a file named `words.xml` in `res/raw`, the identifier is accessible in Java as `R.raw.words`.

Since you can only get an `InputStream`, you have no means of modifying this file. Hence, it is really only useful for static reference data. Moreover, since it is unchanging until the user installs an updated version of your application package, either the reference data has to be valid for the foreseeable future, or you will need to provide some means of updating the data. The simplest way to handle that is to use the reference data to bootstrap some other modifiable form of storage (e.g., a database), but this makes for two copies of the data in storage. An alternative is to keep the reference data as-is but keep modifications in a file or database, and merge them together when you need a complete picture of the information. For example, if your application ships a file of URLs, you could have a second file that tracks URLs added by the user or reference URLs that were deleted by the user.

### XML Resources

If, however, your file is in an XML format, you are better served not putting it in `res/raw/`, but rather in `res/xml/`. This is a directory for XML resources – resources known to be in XML format, but without any assumptions about what that XML represents.

To access that XML, you once again get a `Resources` object by calling `getResources()` on your `Activity` or other `Context`. Then, call `getXml()` on the `Resources` object, supplying the ID value of your XML resource (e.g., `R.xml.words`). This will return an `XmlResourceParser`, which implements the `XmlPullParser` interface. We will discuss how to use this parser, and the performance advantage of using XML resources, [later in this chapter](#).

As with raw resources, XML resources are read-only at runtime.

### Assets

Your third option is to package the data in the form of an asset. You can create an `assets/` directory at the root of your project directory, then place whatever files you want in there. Those are accessible at runtime by calling `getAssets()` on your

Activity or other Context, then calling `open()` with the path to the file (e.g., `assets/foo/index.html` would be retrieved via `open("foo/index.html")`). As with raw resources, this returns an `InputStream` on the file's contents. And, as with all types of resources, assets are read-only at runtime.

One benefit of using assets over raw resources is the `file://android_asset/Uri` prefix. You can use this to load an asset into a `WebView`. For example, for an asset located in `assets/foo/index.html` within your project, calling `loadUrl("file://android_asset/foo/index.html")` will load that HTML into the `WebView`.

Note that assets are compressed when the APK is packaged. Unfortunately, this compression mechanism has a 1MB file size limit. If you wish to package an asset that is bigger than 1MB, you either need to give it a file extension that will not be compressed (e.g., `.mp3`) or actually store a ZIP file of the asset (to avoid the automatic compression) and decompress it yourself at runtime, using the standard `java.util.zip` classes.

## Files and Android

On the whole, Android just uses normal Java file I/O for local files. You will use the same `File` and `InputStream` and `OutputWriter` and other classes that you have used time and again in your prior Java development work.

What is distinctive in Android is *where* you read and write. Akin to writing a Java Web app, you do not have read and write access to arbitrary locations. Instead, there are only a handful of directories to which you have any access, particularly when running on production hardware.

### Internal vs. External

Internal storage refers to your application's portion of the on-board, always-available flash storage. External storage refers to storage space that can be mounted by the user as a drive in Windows (or, possibly with some difficulty, as a volume in OS X or Linux).

On Android 1.x and 2.x, the big advantage of external storage is size. Some Android devices have very little internal storage (tens or hundreds of MB) that *all apps* must share. External storage, on the other hand, typically is on the order of GB of available free space.



However, on Android 1.x and 2.x, external storage is not always available – if it is mounted as a drive or volume on a host desktop or notebook, your app will not have access to external storage. We will examine this limitation in a bit more detail [later in this chapter](#).

### Standard vs. Cache

On both internal and external storage, you have the option of saving files as a cache, or on a more permanent basis. Files located in a cache directory may be deleted by the OS or third-party apps to free up storage space for the user. Files located outside of cache will remain unless manually deleted.

### Yours vs. Somebody Else's

Internal storage is on a per-application basis. Files you write to in your own internal storage cannot be read or written to by other applications... normally. Users who “root” their phones can run apps with superuser privileges and be able to access your internal storage. Most users do not root their phones, and so only your app will be able to access your internal storage files.

Files on external storage, though, are visible to all applications and the user. Anyone can read anything stored there, and any application that requests to can write or delete anything it wants.

## Working with Internal Storage

You have a few options for manipulating the contents of your app's portion of internal storage.

One possibility is to use `openFileInput()` and `openFileOutput()` on your `Activity` or other `Context` to get an `InputStream` and `OutputStream`, respectively. However, these methods do not accept file paths (e.g., `path/to/file.txt`), just simple filenames.

If you want to have a bit more flexibility, `getFilesDir()` and `getCacheDir()` return a `File` object pointing to the roots of your files and cache locations on internal storage, respectively. Given the `File`, you can create files and subdirectories as you see fit.

To see how this works, take a peek at the [Files/ReadWrite](#) sample project.

## ASSETS, FILES, AND DATA PARSING

---

This application implements an `EditorFragment`, containing a full-screen `EditText`, hosted by a `FilesDemoActivity` as a static fragment. There is a `CheckBox` in the action bar to toggle between using internal and external storage:

```
<menu xmlns:android="http://schemas.android.com/apk/res/android">
    <item
        android:id="@+id/location"
        android:actionLayout="@layout/action_location"
        android:showAsAction="always">
    </item>
    <item
        android:id="@+id/save"
        android:icon="@android:drawable/ic_menu_save"
        android:showAsAction="always|withText"
        android:title="@string/save">
    </item>
    <item
        android:id="@+id/saveBackground"
        android:icon="@android:drawable/ic_menu_save"
        android:showAsAction="never"
        android:title="@string/saveBackground">
    </item>
</menu>
```

We get at that `CheckBox` in `onCreateOptionsMenu()` of `EditorFragment`, storing it in a data member of the fragment:

```
@Override
public void onCreateOptionsMenu(Menu menu, MenuInflater inflater) {
    inflater.inflate(R.menu.actions, menu);
    external=(CheckBox)menu.findItem(R.id.location).getActionView();
}
```

When they go to work with the file (e.g., press a Save toolbar button), we use a `getTarget()` method to return a `File` object pointing at the file to be manipulated. In the case where the `CheckBox` is unchecked — meaning we are to use internal storage — `getTarget()` uses `getFilesDir()`:

```
private File getTarget() {
    File root=null;

    if (external!=null && external.isChecked()) {
        root=getActivity().getExternalFilesDir(null);
    }
    else {
        root=getActivity().getFilesDir();
    }
}
```

```
return(new File(root, FILENAME));
}
```

Note that the `CheckBox` may not yet exist, depending on the timing of `onCreateOptionsMenu()` and `onResume()`. That timing varies a bit by Android version.

Methods like `load()` then load that `File` by using standard Java file I/O:

```
private String load(File target) throws IOException {
    String result="";

    try {
        InputStream in=new FileInputStream(target);

        if (in != null) {
            InputStreamReader tmp=new InputStreamReader(in);
            BufferedReader reader=new BufferedReader(tmp);
            String str;
            StringBuilder buf=new StringBuilder();

            while ((str=reader.readLine()) != null) {
                buf.append(str + "\n");
            }

            in.close();
            result=buf.toString();
        }
    }
    catch (java.io.FileNotFoundException e) {
        // that's OK, we probably haven't created it yet
    }

    return(result);
}
```

The files stored in internal storage are accessible only to your application, by default. Other applications on the device have no rights to read, let alone write, to this space. However, bear in mind that some users “root” their Android phones, gaining superuser access. These users will be able to read and write whatever files they wish. As a result, please consider application-local files to be secure against malware but not necessarily secure against interested users.

## Working with External Storage

On most Android 1.x devices and some early Android 2.x devices, external storage came in the form of a micro SD card or the equivalent. On the remaining Android

2.x devices, external storage was part of the on-board flash, but housed in a separate partition from the internal storage. On most Android 3.0+ devices, external storage is now simply a special directory in the partition that holds internal storage.

Devices will have at least 1GB of external storage free when they ship to the user. That being said, many devices have much more than that, but the available size at any point could be smaller than 1GB, depending on how much data the user has stored.

### Where to Write

If you have files that are tied to your application that are simply too big to risk putting in internal storage, or if the user should be able to download the files off their device at will, you can use `getExternalFilesDir()`, available on any activity or other Context. This will give you a `File` object pointing to an automatically-created directory on external storage, unique for your application. While not secure against other applications, it does have one big advantage: when your application is uninstalled, these files are automatically deleted, just like the ones in the application-local file area. This method was added in API Level 8. This method takes one parameter — typically `null` — that indicates a particular type of file you are trying to save (or, later, load).

For example, the aforementioned `getTarget()` method of `EditorFragment` uses `getExternalFilesDir()` if the user has checked the `CheckBox` in the action bar:

```
private File getTarget() {
    File root=null;

    if (external!=null && external.isChecked()) {
        root=getActivity().getExternalFilesDir(null);
    }
    else {
        root=getActivity().getFilesDir();
    }

    return(new File(root, FILENAME));
}
```

There is also `getExternalCacheDir()`, which returns a `File` pointing at a directory that contains files that you would like to have, but if Android or a third-party app clears the cache, your app will continue to function normally.

If you have files that belong more to the user than to your app — pictures taken by the camera, downloaded MP3 files, etc. — a better solution is to use

`getExternalStoragePublicDirectory()`, available on the `Environment` class. This will give you a `File` object pointing to a directory set aside for a certain type of file, based on the type you pass into `getExternalStoragePublicDirectory()`. For example, you can ask for `DIRECTORY_MOVIES`, `DIRECTORY_MUSIC`, or `DIRECTORY_PICTURES` for storing MP4, MP3, or JPEG files, respectively. These files will be left behind when your application is uninstalled. This method was also added in API Level 8.

You will also find a `getExternalStorageDirectory()` method on `Environment`, pointing to the root of the external storage. This is no longer the preferred approach — the methods described above help keep the user's files better organized. However, if you are supporting older Android devices, you may need to use `getExternalStorageDirectory()`, simply because the newer options may not be available to you.

### When to Write

Starting with Android 1.6, you will also need to hold permissions to work with external storage (e.g., `WRITE_EXTERNAL_STORAGE`), as was described in [the preceding chapter](#). For example, here is the sample app's manifest, complete with the `<uses-permission>` element:

```
<?xml version="1.0" encoding="utf-8"?>
<manifest xmlns:android="http://schemas.android.com/apk/res/android"
    package="com.commonware.android.frw"
    android:versionCode="1"
    android:versionName="1.0">

    <uses-sdk
        android:minSdkVersion="9"
        android:targetSdkVersion="14"/>

    <supports-screens
        android:largeScreens="true"
        android:normalScreens="true"
        android:smallScreens="true"
        android:xlargeScreens="true"/>

    <uses-permission android:name="android.permission.WRITE_EXTERNAL_STORAGE"/>

    <application
        android:icon="@drawable/ic_launcher"
        android:label="@string/app_name"
        android:theme="@style/Theme.Sherlock"
        android:uiOptions="splitActionBarWhenNarrow">
        <activity
            android:name=".FilesDemoActivity"
```

```
    android:label="@string/app_name">
    <intent-filter>
        <action android:name="android.intent.action.MAIN" />

        <category android:name="android.intent.category.LAUNCHER" />
    </intent-filter>
    </activity>
</application>
</manifest>
```

Also, external storage may be tied up by the user having mounted it as a USB storage device. You can use `getExternalStorageState()` (a static method on `Environment`) to determine if external storage is presently available or not. On Android 3.0 and higher, this should be much less of an issue, as they changed how the external storage is used by the host PC — originally, this used USB Mass Storage Mode (think thumb drives) and now uses the USB Media Transfer Protocol (think MP3 players). With MTP, both the Android device and the PC it is connected to can have access to the files simultaneously; Mass Storage Mode would only allow the host PC access to the files if external storage is mounted.

### Letting the User See Your Files

The switch to MTP has one side-effect for Android developers: files you write to external storage may not be automatically visible to the user. At the time of this writing, the only files that will show up on the user's PC will be ones that have been indexed by the `MediaStore`. While the `MediaStore` is typically thought of as only indexing "media" (images, audio files, video files, etc.), it was given the added role in Android 3.0 of maintaining an index of *all* files for the purposes of MTP.

Your file that you place on external storage will not be indexed automatically simply by creating it and writing to it. Eventually, it will be indexed, though it may be quite some time for an automatic indexing pass to take place.

To force Android to index your file, you can use `scanFile()` on `MediaScannerConnection`:

```
String[] paths={pathToYourNewFileOnExternalStorage};
MediaScannerConnection.scanFile(this, paths, null, null);
```

The third parameter to `scanFile()` is an array of MIME types, to line up with the array of paths in the second parameter. If your file is some form of media, and you know the MIME type, supplying that will ensure that your media will be visible as

appropriate to the right apps (e.g., images in the Gallery app). Otherwise, Android will try to infer a MIME type from the file extension.

### Permissions for External Storage

Apps have long needed to hold the `WRITE_EXTERNAL_STORAGE` permission to be able to write to external storage.

Starting with Jelly Bean, though, you should consider requesting the `READ_EXTERNAL_STORAGE` permission as well, to be able to read external storage. If you hold `WRITE_EXTERNAL_STORAGE`, you do not also need `READ_EXTERNAL_STORAGE`. But, if you are reading external storage without writing it, you will need to hold `READ_EXTERNAL_STORAGE` sometime in the future. While this is not enforced by default, it is an option for users to turn on in Developer Options in Settings, and it will be enforced in future versions of Android.

However, the 4.1 and 4.2 emulators appear broken, insofar as they do not check the Developer Options preference, and therefore grants access to external storage even if you lack the permission. Hence, to truly test the behavior of this permission, you need appropriate hardware.

Also, please be aware that `READ_EXTERNAL_STORAGE` affects apps that might not realize that they are reading files from external storage, because they are being handed `Uri` values from an Intent or other sources, [such as a ContentProvider](#).

### Limits on External Storage Open Files

Many Android devices will have a per-process limit of 1024 open files, on any sort of storage. This is usually not a problem for developers.

On some devices — including probably all that are running Android 4.2 and higher — there is a *global* limit of 1024 open files on external storage. In other words, all running apps combined can only open 1024 files simultaneously on external storage.

This means that it is important for you to minimize how many open files on external storage you have at a time. Having a few open files is perfectly reasonable; having a few hundred open files is not.

## Multiple User Accounts

On Android 4.1 and earlier, each Android device was assumed to be used by just one person.

On Android 4.2 and higher, though, it is possible for the device owner to set up multiple user accounts. Each user gets their own section of internal and external storage for files, databases, `SharedPreferences`, and so forth. From your standpoint, it is as if the users are really on different devices, even though in reality it is all the same hardware.

However, this means that paths to internal and external storage now may vary by user. Hence, it is *very important* for you to use the appropriate methods, outlined in this chapter, for finding locations on internal storage (e.g., `getFilesDir()`) and external storage (e.g., `getExternalFilesDir()`).

Some blog posts, StackOverflow answers, and the like will show the use of hard-coded paths for these locations (e.g., `/sdcard` or `/mnt/sdcard` for the root of external storage). Hard-coding such paths was never a good idea. And, as of Android 4.2, those paths are simply wrong and will not work.

On Android 4.2 (and perhaps future versions), for the original user of the device, internal storage will wind up in the same location as before, but external storage will use a different path. For the second and subsequent users defined on the device, both internal and external storage will reside in different paths. The various methods, like `getFilesDir()`, will handle this transparently for you.

Note that, at the time of this writing, multiple accounts are not available on the emulators, only on hardware.

## Linux Filesystems: You Sync, You Win

Android is built atop a Linux kernel and uses Linux filesystems for holding its files. Classically, Android used YAFFS (Yet Another Flash File System), optimized for use on low-power devices for storing data to flash memory. Many devices still use YAFFS today.

YAFFS has one big problem: only one process can write to the filesystem at a time. For those of you into filesystems, rather than offering file-level locking, YAFFS has partition-level locking. This can become a bit of a bottleneck, particularly as



Android devices grow in power and start wanting to do more things at the same time like their desktop and notebook brethren.

Android 3.0 switched to ext4, another Linux filesystem aimed more at desktops/notebooks. Your applications will not directly perceive the difference. However, ext4 does a fair bit of buffering, and it can cause problems for applications that do not take this buffering into account. Linux application developers ran headlong into this in 2008–2009, when ext4 started to become popular. Android developers will need to think about it now... for your own file storage.

If you are using SQLite or SharedPreferences, you do not need to worry about this problem. Android (and SQLite, in the case of SQLite) handle all the buffering issues for you. If, however, you write your own files, you may wish to contemplate an extra step as you flush your data to disk. Specifically, you need to trigger a Linux system call known as `fsync()`, which tells the filesystem to ensure all buffers are written to disk.

If you are using `java.io.RandomAccessFile` in a synchronous mode, this step is handled for you as well, so you will not need to worry about it. However, Java developers tend to use `FileOutputStream`, which does not trigger an `fsync()`, even when you call `close()` on the stream. Instead, you call `getFD().sync()` on the `FileOutputStream` to trigger the `fsync()`. Note that this may be time-consuming, and so disk writes should be done off the main application thread wherever practical, such as via an `AsyncTask`.

This is why, in `EditorFragment`, our `save()` implementation looks like this:

```
private void save(String text, File target) throws IOException {
    FileOutputStream fos=new FileOutputStream(target);
    OutputStreamWriter out=new OutputStreamWriter(fos);

    out.write(text);
    out.flush();
    fos.getFD().sync();
    out.close();
}
```

## StrictMode: Avoiding Janky Code

Users are more likely to like your application if, to them, it feels responsive. Here, by “responsive”, we mean that it reacts swiftly and accurately to user operations, like taps and swipes.

Conversely, users are less likely to be happy with you if they perceive that your UI is “janky” — sluggish to respond to their requests. For example, maybe your lists do not scroll as smoothly as they would like, or tapping a button does not yield the immediate results they seek.

While threads and `AsyncTask` and the like can help, it may not always be obvious where you should be applying them. A full-scale performance analysis, using Traceview or similar Android tools, is certainly possible. However, there are a few standard sorts of things that developers do, sometimes quite by accident, on the main application thread that will tend to cause sluggishness:

1. Flash I/O, both for internal and external storage
2. Network I/O

However, even here, it may not be obvious that you are performing these operations on the main application thread. This is particularly true when the operations are really being done by Android’s code that you are simply calling.

That is where `StrictMode` comes in. Its mission is to help you determine when you are doing things on the main application thread that might cause a janky user experience.

`StrictMode` works on a set of policies. There are presently two categories of policies: VM policies and thread policies. The former represent bad coding practices that pertain to your entire application, notably leaking `SQLite Cursor` objects and kin. The latter represent things that are bad when performed on the main application thread, notably flash I/O and network I/O.

Each policy dictates what `StrictMode` should watch for (e.g., flash reads are OK but flash writes are not) and how `StrictMode` should react when you violate the rules, such as:

1. Log a message to `LogCat`
2. Display a dialog
3. Crash your application (seriously!)

The simplest thing to do is call the static `enableDefaults()` method on `StrictMode` from `onCreate()` of your first activity. This will set up normal operation, reporting all violations by simply logging to `LogCat`. However, you can set your own custom policies via `Builder` objects if you so choose.

## ASSETS, FILES, AND DATA PARSING

---

However, do not use `StrictMode` in production code. It is designed for use when you are building, testing, and debugging your application. It is not designed to be used in the field.

In `FilesDemoActivity`, in addition to loading `R.layout.main` with our `EditorFragment` statically defined, we configure `StrictMode`, if and only if we are building a debug version of the app and are on a version of Android that supports `StrictMode`:

```
package com.commonware.android.frw;

import android.os.Build;
import android.os.Bundle;
import android.os.StrictMode;
import com.actionbarsherlock.app.SherlockFragmentActivity;

public class FilesDemoActivity extends SherlockFragmentActivity {
    @Override
    public void onCreate(Bundle savedInstanceState) {
        super.onCreate(savedInstanceState);
        setContentView(R.layout.main);

        if (BuildConfig.DEBUG
            && Build.VERSION.SDK_INT >= Build.VERSION_CODES.GINGERBREAD) {
            StrictMode.setThreadPolicy(buildPolicy());
        }
    }

    private StrictMode.ThreadPolicy buildPolicy() {
        return(new StrictMode.ThreadPolicy.Builder().detectAll()
            .penaltyLog().build());
    }
}
```

Here, we are asking to flag all faults (`detectAll()`), logging any violations to `LogCat` (`penaltyLog()`).

If we press the “Save” action bar item, instead of going to the menu and using “Save in Background”, we will do disk I/O on the main application thread and generate `StrictMode` violations as a result:

```
04-19 11:13:41.522: D/StrictMode(1443): StrictMode policy violation;
~duration=5 ms: android.os.StrictMode$StrictModeDiskReadViolation:
policy=31 violation=2
04-19 11:13:41.522: D/StrictMode(1443): at
android.os.StrictMode$AndroidBlockGuardPolicy.onReadFromDisk(StrictMode.
java:1089)
04-19 11:13:41.522: D/StrictMode(1443): at
libcore.io.BlockGuardOs.open(BlockGuardOs.java:106)
```

## ASSETS, FILES, AND DATA PARSING

---

```
04-19 11:13:41.522: D/StrictMode(1443): at
libcore.io.IoBridge.open(IoBridge.java:390)
04-19 11:13:41.522: D/StrictMode(1443): at
java.io.FileOutputStream.<init>(FileOutputStream.java:88)
04-19 11:13:41.522: D/StrictMode(1443): at
java.io.FileOutputStream.<init>(FileOutputStream.java:73)
04-19 11:13:41.522: D/StrictMode(1443): at
com.commonware.android.frw.EditorFragment.save(EditorFragment.java:106)
04-19 11:13:41.522: D/StrictMode(1443): at
com.commonware.android.frw.EditorFragment.onOptionsItemSelected(EditorF
ragment.java:73)
04-19 11:13:41.522: D/StrictMode(1443): at
com.actionbarsherlock.app.SherlockFragment.onOptionsItemSelected(Sherloc
kFragment.java:67)
04-19 11:13:41.522: D/StrictMode(1443): at
android.support.v4.app.FragmentManagerImpl.dispatchOptionsItemSelected(F
ragmentManager.java:1919)
04-19 11:13:41.522: D/StrictMode(1443): at
android.support.v4.app.FragmentActivity.onMenuItemSelected(FragmentActiv
ity.java:357)
04-19 11:13:41.522: D/StrictMode(1443): at
com.actionbarsherlock.app.SherlockFragmentActivity.onMenuItemSelected(Sh
erlockFragmentActivity.java:288)
04-19 11:13:41.522: D/StrictMode(1443): at
com.actionbarsherlock.ActionBarSherlock.callbackOptionsItemSelected(Acti
onBarSherlock.java:586)
04-19 11:13:41.522: D/StrictMode(1443): at
com.actionbarsherlock.internal.ActionBarSherlockNative.dispatchOptionsIt
emSelected(ActionBarSherlockNative.java:78)
04-19 11:13:41.522: D/StrictMode(1443): at
com.actionbarsherlock.app.SherlockFragmentActivity.onMenuItemSelected(Sh
erlockFragmentActivity.java:191)
04-19 11:13:41.522: D/StrictMode(1443): at
com.android.internal.policy.impl.PhoneWindow.onMenuItemSelected(PhoneWin
dow.java:950)
04-19 11:13:41.522: D/StrictMode(1443): at
com.android.internal.view.menu.MenuBuilder.dispatchMenuItemSelected(Menu
Builder.java:735)
04-19 11:13:41.522: D/StrictMode(1443): at
com.android.internal.view.menu.MenuItemImpl.invoke(MenuItemImpl.java:149
)
04-19 11:13:41.522: D/StrictMode(1443): at
com.android.internal.view.menu.MenuBuilder.performItemAction(MenuBuilder
.java:874)
04-19 11:13:41.522: D/StrictMode(1443): at
com.android.internal.view.menu.ActionMenuView.invokeItem(ActionMenuView.
java:490)
04-19 11:13:41.522: D/StrictMode(1443): at
com.android.internal.view.menu.ActionMenuItemView.onClick(ActionMenuItem
View.java:108)
04-19 11:13:41.522: D/StrictMode(1443): at
android.view.View.performClick(View.java:3511)
04-19 11:13:41.522: D/StrictMode(1443): at
android.view.View$PerformClick.run(View.java:14105)
```

## ASSETS, FILES, AND DATA PARSING

---

```
04-19 11:13:41.522: D/StrictMode(1443): at
android.os.Handler.handleCallback(Handler.java:605)
04-19 11:13:41.522: D/StrictMode(1443): at
android.os.Handler.dispatchMessage(Handler.java:92)
04-19 11:13:41.522: D/StrictMode(1443): at
android.os.Looper.loop(Looper.java:137)
04-19 11:13:41.522: D/StrictMode(1443): at
android.app.ActivityThread.main(ActivityThread.java:4424)
04-19 11:13:41.522: D/StrictMode(1443): at
java.lang.reflect.Method.invokeNative(Native Method)
04-19 11:13:41.522: D/StrictMode(1443): at
java.lang.reflect.Method.invoke(Method.java:511)
04-19 11:13:41.522: D/StrictMode(1443): at
com.android.internal.os.ZygoteInit$MethodAndArgsCaller.run(ZygoteInit.ja
va:784)
04-19 11:13:41.522: D/StrictMode(1443): at
com.android.internal.os.ZygoteInit.main(ZygoteInit.java:551)
04-19 11:13:41.522: D/StrictMode(1443): at
dalvik.system.NativeStart.main(Native Method)
04-19 11:13:41.522: D/StrictMode(1443): StrictMode policy violation;
~duration=2 ms: android.os.StrictMode$StrictModeDiskWriteViolation:
policy=31 violation=1
04-19 11:13:41.522: D/StrictMode(1443): at
android.os.StrictMode$AndroidBlockGuardPolicy.onWriteToDisk(StrictMode.j
ava:1063)
04-19 11:13:41.522: D/StrictMode(1443): at
libcore.io.BlockGuardOs.write(BlockGuardOs.java:190)
04-19 11:13:41.522: D/StrictMode(1443): at
libcore.io.IoBridge.write(IoBridge.java:447)
04-19 11:13:41.522: D/StrictMode(1443): at
java.io.FileOutputStream.write(FileOutputStream.java:187)
04-19 11:13:41.522: D/StrictMode(1443): at
java.io.OutputStreamWriter.flushBytes(OutputStreamWriter.java:167)
04-19 11:13:41.522: D/StrictMode(1443): at
java.io.OutputStreamWriter.flush(OutputStreamWriter.java:158)
04-19 11:13:41.522: D/StrictMode(1443): at
com.commonware.android.frw.EditorFragment.save(EditorFragment.java:110)
04-19 11:13:41.522: D/StrictMode(1443): at
com.commonware.android.frw.EditorFragment.onOptionsItemSelected(EditorF
ragment.java:73)
04-19 11:13:41.522: D/StrictMode(1443): at
com.actionbarsherlock.app.SherlockFragment.onOptionsItemSelected(Sherloc
kFragment.java:67)
04-19 11:13:41.522: D/StrictMode(1443): at
android.support.v4.app.FragmentManagerImpl.dispatchOptionsItemSelected(F
ragmentManager.java:1919)
04-19 11:13:41.522: D/StrictMode(1443): at
android.support.v4.app.FragmentActivity.onMenuItemSelected(FragmentActiv
ity.java:357)
04-19 11:13:41.522: D/StrictMode(1443): at
com.actionbarsherlock.app.SherlockFragmentActivity.onMenuItemSelected(Sh
erlockFragmentActivity.java:288)
04-19 11:13:41.522: D/StrictMode(1443): at
com.actionbarsherlock.ActionBarSherlock.callbackOptionsItemSelected(Acti
```

## ASSETS, FILES, AND DATA PARSING

---

```
onBarSherlock.java:586)
04-19 11:13:41.522: D/StrictMode(1443): at
com.actionbarsherlock.internal.ActionBarSherlockNative.dispatchOptionsItem
Selected(ActionBarSherlockNative.java:78)
04-19 11:13:41.522: D/StrictMode(1443): at
com.actionbarsherlock.app.SherlockFragmentActivity.onMenuItemSelected(Sher
lockFragmentActivity.java:191)
04-19 11:13:41.522: D/StrictMode(1443): at
com.android.internal.policy.impl.PhoneWindow.onMenuItemSelected(PhoneWin
dow.java:950)
04-19 11:13:41.522: D/StrictMode(1443): at
com.android.internal.view.menu.MenuBuilder.dispatchMenuItemSelected(Menu
Builder.java:735)
04-19 11:13:41.522: D/StrictMode(1443): at
com.android.internal.view.menu.MenuItemImpl.invoke(MenuItemImpl.java:149
)
04-19 11:13:41.522: D/StrictMode(1443): at
com.android.internal.view.menu.MenuBuilder.performItemAction(MenuBuilder
.java:874)
04-19 11:13:41.522: D/StrictMode(1443): at
com.android.internal.view.menu.ActionMenuView.invokeItem(ActionMenuView.
java:490)
04-19 11:13:41.522: D/StrictMode(1443): at
com.android.internal.view.menu.ActionMenuItemView.onClick(ActionMenuItem
View.java:108)
04-19 11:13:41.522: D/StrictMode(1443): at
android.view.View.performClick(View.java:3511)
04-19 11:13:41.522: D/StrictMode(1443): at
android.view.View$PerformClick.run(View.java:14105)
04-19 11:13:41.522: D/StrictMode(1443): at
android.os.Handler.handleCallback(Handler.java:605)
04-19 11:13:41.522: D/StrictMode(1443): at
android.os.Handler.dispatchMessage(Handler.java:92)
04-19 11:13:41.522: D/StrictMode(1443): at
android.os.Looper.loop(Looper.java:137)
04-19 11:13:41.522: D/StrictMode(1443): at
android.app.ActivityThread.main(ActivityThread.java:4424)
04-19 11:13:41.522: D/StrictMode(1443): at
java.lang.reflect.Method.invokeNative(Native Method)
04-19 11:13:41.522: D/StrictMode(1443): at
java.lang.reflect.Method.invoke(Method.java:511)
04-19 11:13:41.522: D/StrictMode(1443): at
com.android.internal.os.ZygoteInit$MethodAndArgsCaller.run(ZygoteInit.ja
va:784)
04-19 11:13:41.522: D/StrictMode(1443): at
com.android.internal.os.ZygoteInit.main(ZygoteInit.java:551)
04-19 11:13:41.522: D/StrictMode(1443): at
dalvik.system.NativeStart.main(Native Method)
04-19 11:13:41.522: D/StrictMode(1443): StrictMode policy violation;
~duration=1 ms: android.os.StrictMode$StrictModeDiskWriteViolation:
policy=31 violation=1
04-19 11:13:41.522: D/StrictMode(1443): at
android.os.StrictMode$AndroidBlockGuardPolicy.onWriteToDisk(StrictMode.j
ava:1063)
```

## ASSETS, FILES, AND DATA PARSING

---

```
04-19 11:13:41.522: D/StrictMode(1443): at
libcore.io.BlockGuardOs.fsync(BlockGuardOs.java:96)
04-19 11:13:41.522: D/StrictMode(1443): at
java.io.FileDescriptor.sync(FileDescriptor.java:71)
04-19 11:13:41.522: D/StrictMode(1443): at
com.commonware.android.frw.EditorFragment.save(EditorFragment.java:111)
04-19 11:13:41.522: D/StrictMode(1443): at
com.commonware.android.frw.EditorFragment.onOptionsItemSelected(EditorF
ragment.java:73)
04-19 11:13:41.522: D/StrictMode(1443): at
com.actionbarsherlock.app.SherlockFragment.onOptionsItemSelected(Sherloc
kFragment.java:67)
04-19 11:13:41.522: D/StrictMode(1443): at
android.support.v4.app.FragmentManagerImpl.dispatchOptionsItemSelected(F
ragmentManager.java:1919)
04-19 11:13:41.522: D/StrictMode(1443): at
android.support.v4.app.FragmentActivity.onMenuItemSelected(FragmentActiv
ity.java:357)
04-19 11:13:41.522: D/StrictMode(1443): at
com.actionbarsherlock.app.SherlockFragmentActivity.onMenuItemSelected(Sh
erlockFragmentActivity.java:288)
04-19 11:13:41.522: D/StrictMode(1443): at
com.actionbarsherlock.ActionBarSherlock.callbackOptionsItemSelected(Acti
onBarSherlock.java:586)
04-19 11:13:41.522: D/StrictMode(1443): at
com.actionbarsherlock.internal.ActionBarSherlockNative.dispatchOptionsIt
emSelected(ActionBarSherlockNative.java:78)
04-19 11:13:41.522: D/StrictMode(1443): at
com.actionbarsherlock.app.SherlockFragmentActivity.onMenuItemSelected(Sh
erlockFragmentActivity.java:191)
04-19 11:13:41.522: D/StrictMode(1443): at
com.android.internal.policy.impl.PhoneWindow.onMenuItemSelected(PhoneWin
dow.java:950)
04-19 11:13:41.522: D/StrictMode(1443): at
com.android.internal.view.menu.MenuBuilder.dispatchMenuItemSelected(Menu
Builder.java:735)
04-19 11:13:41.522: D/StrictMode(1443): at
com.android.internal.view.menu.MenuItemImpl.invoke(MenuItemImpl.java:149
)
04-19 11:13:41.522: D/StrictMode(1443): at
com.android.internal.view.menu.MenuBuilder.performItemAction(MenuBuilder
.java:874)
04-19 11:13:41.522: D/StrictMode(1443): at
com.android.internal.view.menu.ActionMenuView.invokeItem(ActionMenuView.
java:490)
04-19 11:13:41.522: D/StrictMode(1443): at
com.android.internal.view.menu.ActionMenuItemView.onClick(ActionMenuItem
View.java:108)
04-19 11:13:41.522: D/StrictMode(1443): at
android.view.View.performClick(View.java:3511)
04-19 11:13:41.522: D/StrictMode(1443): at
android.view.View$PerformClick.run(View.java:14105)
04-19 11:13:41.522: D/StrictMode(1443): at
android.os.Handler.handleCallback(Handler.java:605)
```

```
04-19 11:13:41.522: D/StrictMode(1443): at
android.os.Handler.dispatchMessage(Handler.java:92)
04-19 11:13:41.522: D/StrictMode(1443): at
android.os.Looper.loop(Looper.java:137)
04-19 11:13:41.522: D/StrictMode(1443): at
android.app.ActivityThread.main(ActivityThread.java:4424)
04-19 11:13:41.522: D/StrictMode(1443): at
java.lang.reflect.Method.invokeNative(Native Method)
04-19 11:13:41.522: D/StrictMode(1443): at
java.lang.reflect.Method.invoke(Method.java:511)
04-19 11:13:41.522: D/StrictMode(1443): at
com.android.internal.os.ZygoteInit$MethodAndArgsCaller.run(ZygoteInit.ja
va:784)
04-19 11:13:41.522: D/StrictMode(1443): at
com.android.internal.os.ZygoteInit.main(ZygoteInit.java:551)
04-19 11:13:41.522: D/StrictMode(1443): at
dalvik.system.NativeStart.main(Native Method)
```

While wordy, and logged only at debug severity, this is enough to point out where in your code the violation occurred — in our case, in `onOptionsItemSelected()` of `EditorFragment`.

Note that `StrictMode` will also report leaked open files. For example, if you create a `FileOutputStream` on a `File` and fail to `close()` it later, when the `FileOutputStream` (and related objects) are garbage-collected, `StrictMode` will report to you the fact that you failed to close the stream. This is very useful to help you make sure that you are not leaking open files that may contribute to [exhausting the 1,024 open file limit on external storage](#).

## XML Parsing Options

Android supports a fairly standard implementation of the Java DOM and SAX APIs. If you have existing experience with these, or if you have code that already leverages them, feel free to use them.

Android also bakes in the `XmlPullParser` from [the xmlpull.org site](#). Like SAX, the `XmlPullParser` is an event-driven interface, compared to the DOM that builds up a complete data structure and hands you that result. Unlike SAX, which relies on a listener and callback methods, the `XmlPullParser` has you pull events off a queue, ignoring those you do not need and dispatching the rest as you see fit to the rest of your code.

The primary reason the `XmlPullParser` was put into Android was for XML-encoded resources. While you write plain-text XML during development, what is packaged in



your APK file is a so-called “binary XML” format, where angle brackets and quotation marks and such are replaced by bitfields. This helps compression a bit, but mostly this conversion is done to speed up parsing. Android’s XML resource parser can parse this “binary XML” approximately ten times faster than it can parse the equivalent plain-text XML. Hence, anything you put in an XML resource (`res/xml/`) will be parsed similarly quickly.

For plain-text XML content, the `XmlPullParser` is roughly equivalent, speed-wise, to SAX. All else being equal, lean towards SAX, simply because more developers will be familiar with it from classic Java development. However, if you really like the `XmlPullParser` interface, feel free to use it.

You are welcome to try a third-party XML parser JAR, but bear in mind [that there may be issues when trying to get it working in Android](#).

## JSON Parsing Options

Android has bundled the `org.json` classes into the SDK since the beginning, for use in parsing JSON. These classes have a DOM-style interface: you hand `JSONObject` a hunk of JSON, and it gives you an in-memory representation of the completely parsed result. This is handy but, like the DOM, a bit of a performance hog.

API Level 11 added `JSONReader`, based on Google’s GSON parser, as a “streaming” parser alternative. `JSONReader` is much more reminiscent of the `XmlPullParser`, in that you pull events out of the “reader” and process them. This can have significant performance advantages, particularly in terms of memory consumption, if you do not need the entire JSON data structure. However, this is only available on API Level 11 and higher.

Because `JSONReader` is a bit “late to the party”, there has been extensive work on getting other JSON parsers working on Android. The best third-party option today is [Jackson](#). Jackson offers a few APIs, and the streaming API reportedly works very nicely on Android with top-notch performance.

# **Tutorial #11 - Adding Simple Content**

---

Now that we have seen how to work with assets, we can start putting them to use, by defining some “help” and “about” HTML files and displaying them in their respective activities.

This is a continuation of the work we did in [the previous tutorial](#).

You can find [the results of the previous tutorial](#) and [the results of this tutorial](#) in [the book’s GitHub repository](#).

Note that if you are importing the previous code to begin work here, you will also need the [copy of ActionBarSherlock in this book’s GitHub repository](#), and to make sure that your imported EmPubLite project references the ActionBarSherlock project as a library.

## **Step #1: Adding Some Content**

Your project should already have an `assets/` folder. If not, create one. In Eclipse, you would do this by right-clicking over the project in the Package Explorer, choosing `New > Folder` from the context menu, filling in the name `assets` in the dialog, and clicking “Finish”.

In `assets/`, create a `misc/` sub-folder — Eclipse users would use the same technique as above, but start by right-clicking over the `assets/` folder instead of the project.

In `assets/misc/`, create two files, `about.html` and `help.html`. Eclipse users can create files by right-clicking over the folder, choosing `New > File` from the context menu, supplying the name of the file, and clicking “Finish”. The actual HTML content of these two files does not matter, so long as you can tell them apart when

looking at them. If you prefer, you can download sample [about.html](#) and [help.html](#) files from the application's GitHub repository, via the links.

Eclipse users should note that the default behavior of double-clicking on an HTML file in the IDE is to open it in some Eclipse-supplied internal browser. This is not especially useful. If you right-click over the file and choose Open With > Text Editor, from that point forward that specific file will be opened in an editor pane you can use to add or edit the HTML you want to have.

## Step #2: Create a SimpleContentFragment

Now, we need to arrange to load this content. `WebViewFragment` and `AbstractContentFragment` are fine and all, but neither know how to actually load anything. In `AbstractContentFragment`, this is handled by `getPage()`, which is an abstract method. So, let's create a `SimpleContentFragment` subclass of `AbstractContentFragment` that knows how to load files out of our project's assets.

If you wish to make this change using Eclipse's wizards and tools, follow the instructions in the "Eclipse" section below. Otherwise, follow the instructions in the "Outside of Eclipse" section (appears after the "Eclipse" section).

### Eclipse

Right click over the `com.commonware.empublite` package in the `src/` folder of your project, and choose New > Class from the context menu. Fill in `SimpleContentFragment` in the "Name" field. Then, click the "Browse..." button next to the "Superclass" field and find `AbstractContentFragment` to set as the superclass. Then, click "Finish" on the new-class dialog to create the `SimpleContentFragment` class.

Then, replace its contents with the following:

```
package com.commonware.empublite;

import android.os.Bundle;

public class SimpleContentFragment extends AbstractContentFragment {
    private static final String KEY_FILE="file";

    protected static SimpleContentFragment newInstance(String file) {
        SimpleContentFragment f=new SimpleContentFragment();

        Bundle args=new Bundle();
```

```
args.putString(KEY_FILE, file);
f.setArguments(args);

return(f);
}

@Override
String getPage() {
    return(getArguments().getString(KEY_FILE));
}
}
```

### Outside of Eclipse

Create a `src/com/commonsware/empublite/SimpleContentFragment.java` source file, with the content shown above.

## Step #3: Examining SimpleContentFragment

`SimpleContentFragment` does indeed override our `getPage()` abstract method. What it returns is a value out of the “arguments” `Bundle` supplied to the fragment — specifically the string identified as `KEY_FILE`.

`SimpleContentFragment` sets up those arguments via a `newInstance()` static factory method. This method creates an instance of `SimpleContentFragment`, takes a passed-in `String` (pointing to the file to load), puts it in a `Bundle` identified as `KEY_FILE`, hands the `Bundle` to the fragment as its arguments, and returns the newly-created `SimpleContentFragment`.

This means that anyone wanting to use `SimpleContentFragment` should use the factory method, to provide the path to the content to load.

## Step #4: Using SimpleContentFragment

Now, we need to use this fragment in an activity somewhere. We already set up a stub `SimpleContentActivity` for this purpose, but we left its implementation completely empty.

Now, open up `SimpleContentActivity` and fill in the following Java:

```
package com.commonsware.empublite;
```

## TUTORIAL #11 - ADDING SIMPLE CONTENT

---

```
import android.os.Bundle;
import android.support.v4.app.Fragment;
import com.actionbarsherlock.app.SherlockFragmentActivity;

public class SimpleContentActivity extends SherlockFragmentActivity {
    public static final String EXTRA_FILE="file";

    @Override
    public void onCreate(Bundle savedInstanceState) {
        super.onCreate(savedInstanceState);
        if (getSupportFragmentManager().findFragmentById(android.R.id.content) ==
null) {
            String file=getIntent().getStringExtra(EXTRA_FILE);
            Fragment f=SimpleContentFragment.newInstance(file);
            getSupportFragmentManager().beginTransaction()
                .add(android.R.id.content, f).commit();
        }
    }
}
```

In `onCreate()`, we follow the standard recipe for defining our fragment if (and only if) we were started new, rather than restarted after a configuration change, by seeing if the fragment already exists. If we do need to add the fragment, we retrieve a string extra from the Intent used to launch us (identified as `EXTRA_FILE`), create an instance of `SimpleContentFragment` using that value from the extra, and execute a `FragmentManager` transaction to add the `SimpleContentFragment` to our UI.

## Step #5: Launching Our Activities, For Real This Time

Now, what remains is to actually supply that `EXTRA_FILE` value, which we are not doing presently when we start up `SimpleContentActivity` from `EmPubLiteActivity`.

Modify `onOptionsItemSelected()` of `EmPubLiteActivity` to look like this:

```
@Override
public boolean onOptionsItemSelected(MenuItem item) {
    switch (item.getItemId()) {
        case android.R.id.home:
            return(true);

        case R.id.about:
            Intent i=new Intent(this, SimpleContentActivity.class);

            i.putExtra(SimpleContentActivity.EXTRA_FILE,
                "file:///android_asset/misc/about.html");
            startActivity(i);
    }
}
```

## TUTORIAL #11 - ADDING SIMPLE CONTENT

---

```
        return(true);

    case R.id.help:
        i=new Intent(this, SimpleContentActivity.class);
        i.putExtra(SimpleContentActivity.EXTRA_FILE,
            "file:///android_asset/misc/help.html");

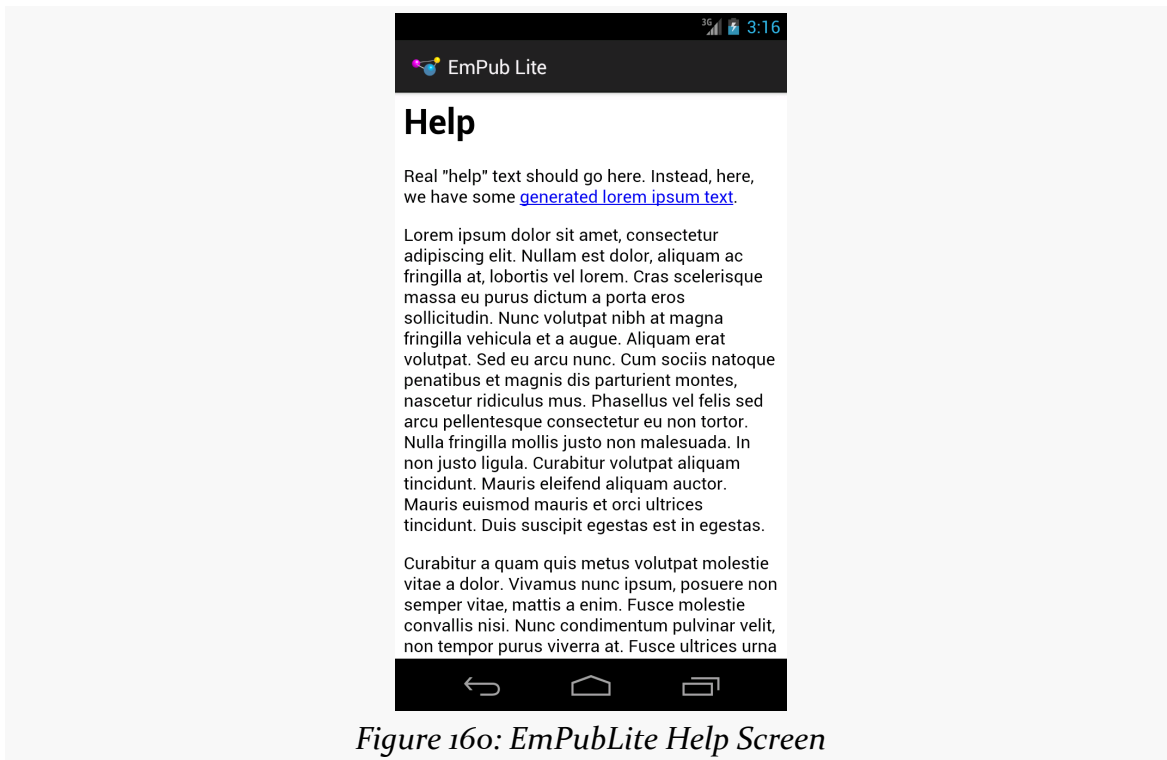
        startActivity(i);

        return(true);
    }

    return(super.onOptionsItemSelected(item));
}
```

You are adding the two `putExtra()` calls in the `R.id.about` and `R.id.help` branches of the switch statement. In both cases, we are using a quasi-URL with the prefix `file:///android_asset/`. This points to the root of our project's `assets/` folder. `WebView` knows how to interpret these URLs, to load files out of our assets directly.

Now, if you run the application and choose “Help” from the action bar overflow, you will see your help content on-screen:



*Figure 160: EmPubLite Help Screen*

## TUTORIAL #11 - ADDING SIMPLE CONTENT

---

Pressing BACK and choosing “About” from the action bar overflow will bring up your about content:



*Figure 161: EmPubLite About Screen*

## In Our Next Episode...

... we will [display the actual content of our book](#) in our tutorial project.

# Tutorial #12 - Displaying the Book

---

At this point, you are probably wondering when we are *ever* going to have our digital book reader let us read a digital book.

Now, in this tutorial, your patience will be rewarded.

This is a continuation of the work we did in [the previous tutorial](#).

You can find [the results of the previous tutorial](#) and [the results of this tutorial](#) in [the book's GitHub repository](#).

Note that if you are importing the previous code to begin work here, you will also need the [copy of ActionBarSherlock in this book's GitHub repository](#), and to make sure that your imported EmPubLite project references the ActionBarSherlock project as a library.

## Step #1: Adding a Book

First, we need a book. Expecting you to write a book as part of this tutorial would seem to be a bit excessive. So, instead, we will use an already-written book: [The War of the Worlds](#), by H. G. Wells, as distributed by [Project Gutenberg](#).

**EDITOR'S NOTE:** We realize that this choice of book may be seen as offensive by Martians, as it depicts them as warlike invaders with limited immune systems. Please understand that this book is a classic of Western literature and reflects the attitude of the times. If you have any concerns about this material, please contact us at [martians-so-do-not-exist@commonsware.com](mailto:martians-so-do-not-exist@commonsware.com).



Download <http://misc.commonsware.com/WarOfTheWorlds.zip> and unpack its contents (a book/ directory of files) into your assets/ folder of your project. Eclipse users can drag this book/ directory into the Package Manager and drop it in assets/ to copy the files to the proper location. You should wind up with assets/book/ and files inside of there.

In that directory, you will find some HTML and CSS files with the prose of the book, plus a contents.json file with metadata. We will examine this metadata in greater detail in the next section.

## Step #2: Defining Our Model

That contents.json file contains a bit of metadata about the contents of the book: the book's title and a roster of its "chapters":

```
{
  "title": "The War of the Worlds",
  "chapters": [
    {
      "file": "0.htm",
      "title": "Book One: Chapters 1-9"
    },
    {
      "file": "1.htm",
      "title": "Book One: Chapters 10-14"
    },
    {
      "file": "2.htm",
      "title": "Book One: Chapters 14-17"
    },
    {
      "file": "3.htm",
      "title": "Book Two: Chapters 1-7"
    },
    {
      "file": "4.htm",
      "title": "Book Two: Chapters 7-10"
    },
    {
      "file": "5.htm",
      "title": "Project Gutenberg"
    }
  ]
}
```

In the case of this book from Project Gutenberg, the assets/book/ directory contains five HTML files which EmPubLite will consider as "chapters", even though

## TUTORIAL #12 - DISPLAYING THE BOOK

---

each of those HTML files contains multiple chapters from the source material. You are welcome to reorganize that HTML if you wish, updating `contents.json` to match.

We need to load `contents.json` into memory, so `EmPubLite` knows how many chapters to display and where those chapters can be found. We will pour `contents.json` into a `BookContents` model object, leveraging the `org.json` parsing classes.

If you wish to make this change using Eclipse's wizards and tools, follow the instructions in the "Eclipse" section below. Otherwise, follow the instructions in the "Outside of Eclipse" section (appears after the "Eclipse" section).

### Eclipse

Right click over the `com.commonware.empublite` package in the `src/` folder of your project, and choose `New > Class` from the context menu. Fill in `BookContents` in the "Name" field. Leave the "Superclass" field alone, as `BookContents` has no explicit superclass. Then, click "Finish" on the new-class dialog to create the `BookContents` class.

Then, with `BookContents` open in the editor, paste in the following class definition:

```
package com.commonware.empublite;

import org.json.JSONArray;
import org.json.JSONObject;

public class BookContents {
    JSONObject raw=null;
    JSONArray chapters;

    BookContents(JSONObject raw) {
        this.raw=raw;
        chapters=raw.optJSONArray("chapters");
    }

    int getChapterCount() {
        return(chapters.length());
    }

    String getChapterFile(int position) {
        JSONObject chapter=chapters.optJSONObject(position);

        return(chapter.optString("file"));
    }
}
```

```
String getTitle() {  
    return(raw.optString("title"));  
}  
}
```

### Outside of Eclipse

Create a `src/com/commonsware/empublite/BookContents.java` source file, with the content shown above.

### Step #3: Examining Our Model

Our `BookContents` constructor takes a `JSONObject` parameter. This will be supplied by some other code that we have not yet written, and it will contain the entire `contents.json` structure. `JSONObject` behaves a bit like the XML DOM, in that it holds the entire parsed content in memory.

`BookContents` is partially a wrapper around the `JSONObject`, offering getters for specific bits of information, notably:

- `getChapterCount()` to identify the number of chapters (i.e., the size of the `JSONArray` created from our `chapters` array in the JSON)
- `getChapterFile()`, to return the relative path within `assets/book/` that represents our “chapter” of HTML
- `getTitle()` to retrieve the book title out of the object

### Step #4: Creating a ModelFragment

Something has to load that `BookContents`, ideally in the background, since reading an asset and parsing the JSON will take time.

Something has to hold onto that `BookContents`, so it can be used from `EmPubLiteActivity` and the various chapter fragments in the `ViewPager`.

In our case, we will use the “model fragment” approach outlined in [a previous chapter](#), with a new class, cunningly named `ModelFragment`.

If you wish to make this change using Eclipse’s wizards and tools, follow the instructions in the “Eclipse” section below. Otherwise, follow the instructions in the “Outside of Eclipse” section (appears after the “Eclipse” section).

### Eclipse

Right click over the `com.commonware.empublite` package in the `src/` folder of your project, and choose `New > Class` from the context menu. Fill in `ModelFragment` in the “Name” field. Then, click the “Browse...” button next to the “Superclass” field and find `SherlockFragment` to set as the superclass. Then, click “Finish” on the new-class dialog to create the `ModelFragment` class.

Finally, paste in the following definition for `ModelFragment`:

```
package com.commonware.empublite;

import android.annotation.TargetApi;
import android.content.Context;
import android.os.AsyncTask;
import android.os.Build;
import android.os.Bundle;
import android.util.Log;
import java.io.BufferedReader;
import java.io.InputStream;
import java.io.InputStreamReader;
import com.actionbarsherlock.app.SherlockFragment;
import org.json.JSONObject;

public class ModelFragment extends SherlockFragment {
    private BookContents contents=null;
    private ContentsLoadTask contentsTask=null;

    @Override
    public void onActivityCreated(Bundle savedInstanceState) {
        super.onActivityCreated(savedInstanceState);

        setRetainInstance(true);
        deliverModel();
    }

    synchronized private void deliverModel() {
        if (contents != null) {
            ((EmPubLiteActivity) getActivity()).setupPager(contents);
        }
        else {
            if (contents == null && contentsTask == null) {
                contentsTask=new ContentsLoadTask();
                executeAsyncTask(contentsTask,
                    getActivity().getApplicationContext());
            }
        }
    }

    @TargetApi(11)
    static public <T> void executeAsyncTask(AsyncTask<T, ?, ?> task,
```

## TUTORIAL #12 - DISPLAYING THE BOOK

---

```
        T... params) {
    if (Build.VERSION.SDK_INT >= Build.VERSION_CODES.HONEYCOMB) {
        task.executeOnExecutor(AsyncTask.THREAD_POOL_EXECUTOR, params);
    }
    else {
        task.execute(params);
    }
}

private class ContentsLoadTask extends AsyncTask<Context, Void, Void> {
    private BookContents localContents=null;
    private Exception e=null;

    @Override
    protected Void doInBackground(Context... ctxt) {
        try {
            StringBuilder buf=new StringBuilder();
            InputStream json=ctxt[0].getAssets().open("book/contents.json");
            BufferedReader in=
                new BufferedReader(new InputStreamReader(json));
            String str;

            while ((str=in.readLine()) != null) {
                buf.append(str);
            }

            in.close();

            localContents=new BookContents(new JSONObject(buf.toString()));
        }
        catch (Exception e) {
            this.e=e;
        }

        return(null);
    }

    @Override
    public void onPostExecute(Void arg0) {
        if (e == null) {
            ModelFragment.this.contents=localContents;
            ModelFragment.this.contentsTask=null;
            deliverModel();
        }
        else {
            Log.e(getClass().getSimpleName(), "Exception loading contents",
                e);
        }
    }
}
}
```

Note that Eclipse is going to complain that a non-existent `setupPager()` is being called, but we will fix that later in this chapter.

### Outside of Eclipse

Create a `src/com/commonsware/empublite/ModelFragment.java` source file, with the content shown above.

## Step #5: Examining the ModelFragment

The point behind `ModelFragment` is to load our data (asynchronously) and hold onto it, using the retained-fragment pattern.

The catch is that even though we are retaining the fragment and holding onto the model data, the activity housing this fragment will still be destroyed and recreated on a configuration change, like a screen rotation. So, the first time our fragment is used, we need to load the content; the second and subsequent times the fragment is used, we need to simply hand over the already-loaded content. Combine that with the (slight) possibility that the user might rotate the screen before we completed loading the content the first time, and things can get a wee bit complicated.

`ModelFragment` overrides `onActivityCreated()`, to get control once `EmPubLiteActivity` has created the `ViewPager` and so on. Here, we call `setRetainInstance(true)`, so the work we do to load the `BookContents` does not evaporate, and we call a `deliverModel()` method.

The `deliverModel()` method is responsible for determining if we have our model data, handing that over to the activity (via `setupPager()`) if we do, or starting a `ContentsLoadTask` if we do not.

Starting a `ContentsLoadTask` is delegated to a static `executeAsyncTask()` method that is designed to work around the limitation established in API Level 14, where `AsyncTask` becomes serialized, with only one task executing at a time. While we only *have* one task at the moment, that will change soon enough. And, while we have our `android:targetSdkVersion` set to 11, and therefore the serialized `AsyncTask` behavior should not take effect (that requires a value of 14 or higher), it is good form to start addressing this sooner rather than later. The details of what `executeAsyncTask()` is doing and how it is doing it will be covered in [a later chapter](#).

## TUTORIAL #12 - DISPLAYING THE BOOK

---

You may notice that we are calling `executeAsyncTask()` with a parameter of `getActivity().getApplicationContext().getApplicationContext()`. `getApplicationContext()` returns a singleton `Context` object (actually an instance of an `Application`). This is useful in cases where we need a `Context` that will be around all the time. It is unsafe for us to reference an `Activity` in a background thread, as the `Activity` could conceivably be destroyed while the thread is in operation. The `Application` will not be destroyed so long as our process is running, so it is safer to use from a background thread.

The `ContentsLoadTask` itself is an `AsyncTask`, much akin to others we have seen so far in this book. In `doInBackground()`, we read in `assets/book/contents.json` by means of an `AssetManager` (obtained from the `Context` via `getAssets()`) and its `open()` method. This returns an `InputStream`, which we stream into a `StringBuilder`. We then parse that as JSON using `JSONObject`, passing the result into a `BookContents` instance.

In `onPostExecute()`, we take advantage of the fact that this is called on the main application thread, meaning we are not executing anything else on the main application thread at the time. So, it is safe for us to update our contents and `contentsTask` data members, plus trigger a call to `deliverModel()`, which will pass the `BookContents` along to the `EmPubLiteActivity`. If something went wrong during the JSON load, and we had an exception, `doInBackground()` saves that in a data member of the `ContentsLoadTask`. `onPostExecute()` could arrange to display the error message to the user — for simplicity, we are only logging it to `LogCat` at the moment.

## Step #6: Supplying the Content

Now, we need to add that missing `setupPager()` method on `EmPubLiteActivity`. Define the method, taking a `BookContents` as a parameter, and returning `void`:

```
void setupPager(BookContents contents) {  
}
```

Move these four lines from `onCreate()` to `setupPager()`:

```
adapter=new ContentsAdapter(this);  
pager.setAdapter(adapter);  
  
findViewById(R.id.progressBar1).setVisibility(View.GONE);  
findViewById(R.id.pager).setVisibility(View.VISIBLE);
```

## TUTORIAL #12 - DISPLAYING THE BOOK

---

Finally, pass the `BookContents` to the `ContentsAdapter` constructor as the second parameter, despite the fact that Eclipse will complain because we have not implemented that yet (we will shortly). You should wind up with a `setupPager()` that resembles:

```
void setupPager(BookContents contents) {
    adapter=new ContentsAdapter(this, contents);
    pager.setAdapter(adapter);

    findViewById(R.id.progressBar1).setVisibility(View.GONE);
    findViewById(R.id.pager).setVisibility(View.VISIBLE);
}
```

We also need to add some code to set up the `ModelFragment` — it will not magically appear on its own. So, the first time we create an `EmPubLiteActivity`, we want to create our `ModelFragment`. To do that, define a static data member named `MODEL`:

```
private static final String MODEL="model";
```

Then, modify `onCreate()` to see if we already have the fragment before creating one:

```
@Override
protected void onCreate(Bundle savedInstanceState) {
    super.onCreate(savedInstanceState);

    if (getSupportFragmentManager().findFragmentByTag(MODEL) == null) {
        getSupportFragmentManager().beginTransaction()
            .add(new ModelFragment(), MODEL)
            .commit();
    }

    setContentView(R.layout.main);

    pager=(ViewPager)findViewById(R.id.pager);
}
```

### Step #7: Adapting the Content

Finally, we need to update `ContentsAdapter` to actually use the `BookContents` and display the prose on the screen.

First, add a `BookContents` data member to `ContentsAdapter`:

```
private BookContents contents=null;
```



## TUTORIAL #12 - DISPLAYING THE BOOK

---

Then, add the BookContents parameter to the constructor, assigning it to the new data member:

```
public ContentsAdapter(SherlockFragmentActivity ctxt,
                      BookContents contents) {
    super(ctxt.getSupportFragmentManager());

    this.contents=contents;
}
```

Next, update getCount() to use the getChapterCount() of our BookContents:

```
@Override
public int getCount() {
    return(contents.getChapterCount());
}
```

Finally, modify getItem() to retrieve the relative path for a given chapter from the BookContents and create a SimpleContentFragment on the complete file:///android\_asset path to the file in question:

```
@Override
public Fragment getItem(int position) {
    String path=contents.getChapterFile(position);

    return(SimpleContentFragment.newInstance("file:///android_asset/book/"
        + path));
}
```

If you run the result in a device or emulator, you will see the book content appear:

## TUTORIAL #12 - DISPLAYING THE BOOK

---

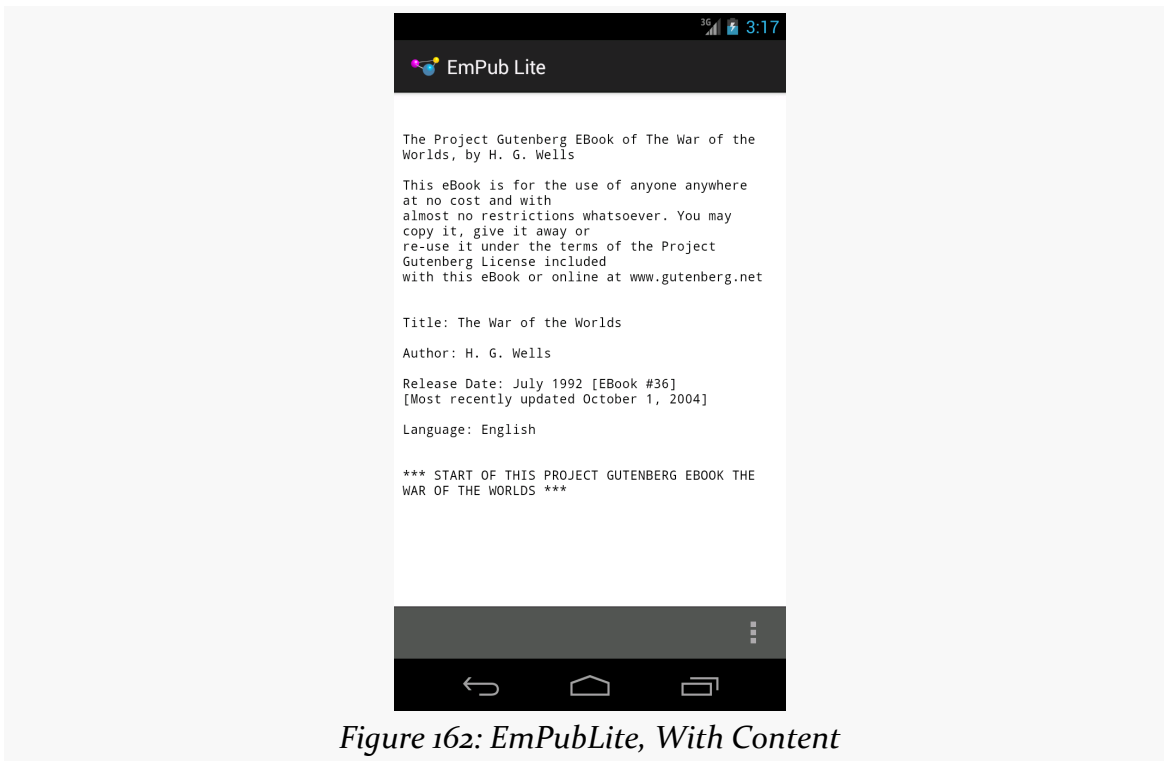


Figure 162: EmPubLite, With Content

Swiping left and right will take you to the other chapters in the book.

### Step #8: Going Home, Again

We can now take advantage of the icon in the action bar (a.k.a., the “home affordance”), using it to bring us back to the first chapter. While the first chapter in our book is not very distinctive compared to the other chapters, you might have a table of contents or a cover or something as the first “chapter”.

The big thing that you need to do to support this is add one line to our `android.R.id.home` portion of the `switch()` in `onOptionsItemSelected()`, telling the `ViewPager` to go back to the first page:

```
case android.R.id.home:
    pager.setCurrentItem(0, false);
    return(true);
```

You also need to teach the action bar to support taps on this “home affordance”, by adding this line to the bottom of your `onCreate()` of `EmPubLiteActivity`:

## TUTORIAL #12 - DISPLAYING THE BOOK

---

```
getSupportActionBar().setHomeButtonEnabled(true);
```

If you run this on a device or emulator, swipe to some later chapter, then tap the icon in the upper-left corner, you will be returned to the first chapter.

### In Our Next Episode...

... we will allow the user to [manipulate some preferences](#) in our tutorial project.

# Using Preferences

---

Android has many different ways for you to store data for long-term use by your activity. The simplest ones to use are `SharedPreferences` and simple files.

Android allows activities and applications to keep preferences, in the form of key/value pairs (akin to a `Map`), that will hang around between invocations of an activity. As the name suggests, the primary purpose is for you to store user-specified configuration details, such as the last feed the user looked at in your feed reader, or what sort order to use by default on a list, or whatever. Of course, you can store in the preferences whatever you like, so long as it is keyed by a `String` and has a primitive value (`boolean`, `String`, etc.)

Preferences can either be for a single activity or shared among all activities in an application. Other components, such as services, also can work with shared preferences.

## Getting What You Want

To get access to the preferences, you have three APIs to choose from:

- `getPreferences()` from within your `Activity`, to access activity-specific preferences
- `getSharedPreferences()` from within your `Activity` (or other application `Context`), to access application-level preferences
- `getDefaultSharedPreferences()`, on `PreferenceManager`, to get the shared preferences that work in concert with Android's overall preference framework

The first two take a security mode parameter — the right answer here is `MODE_PRIVATE`, so no other applications can access the file. The `getSharedPreferences()` method also takes a name of a set of preferences — `getPreferences()` effectively calls `getSharedPreferences()` with the activity's class name as the preference set name. The `getDefaultSharedPreferences()` method takes the `Context` for the preferences (e.g., your `Activity`).

All of those methods return an instance of `SharedPreferences`, which offers a series of getters to access named preferences, returning a suitably-typed result (e.g., `getBoolean()` to return a boolean preference). The getters also take a default value, which is returned if there is no preference set under the specified key.

Unless you have a good reason to do otherwise, you are best served using the third option above — `getDefaultSharedPreferences()` — as that will give you the `SharedPreferences` object that works with a `PreferenceActivity` by default, as will be described [later in this chapter](#).

## Stating Your Preference

Given the appropriate `SharedPreferences` object, you can use `edit()` to get an “editor” for the preferences. This object has a set of setters that mirror the getters on the parent `SharedPreferences` object. It also has:

1. `remove()` to get rid of a single named preference
2. `clear()` to get rid of all preferences
3. `apply()` or `commit()` to persist your changes made via the editor

The last one is important — if you modify preferences via the editor and fail to save the changes, those changes will evaporate once the editor goes out of scope. `commit()` is a blocking call, while `apply()` works asynchronously. Ideally, use `apply()` where possible, though it was only added in Android 2.3, so it may not be available to you if you are aiming to support earlier versions of Android than that.

Conversely, since the preferences object supports live changes, if one part of your application (say, an activity) modifies shared preferences, another part of your application (say, a service) will have access to the changed value immediately.

## Introducing PreferenceActivity

You could roll your own activity to collect preferences from the user. On the whole, this is a bad idea. Instead, use preference XML resources and a PreferenceActivity.

Why?

One of the common complaints about Android developers is that they lack discipline, not following any standards or conventions inherent in the platform. For other operating systems, the device manufacturer might prevent you from distributing apps that violate their human interface guidelines. With Android, that is not the case — but this is not a blanket permission to do whatever you want. Where there is a standard or convention, please follow it, so that users will feel more comfortable with your app and their device.

Using a PreferenceActivity for collecting preferences is one such convention.

The linchpin to the preferences framework and PreferenceActivity is yet another set of XML data structures. You can describe your application's preferences in XML files stored in your project's `res/xml/` directory. Given that, Android can present a pleasant UI for manipulating those preferences, which are then stored in the SharedPreferences you get back from `getDefaultSharedPreferences()`.

To see how all of this works, take a look at the [Prefs/FragmentsBC](#) sample project.

### What We Are Aiming For

This project's main activity hosts a `TableLayout`, into which we will load the values of five preferences:

```
<?xml version="1.0" encoding="utf-8"?>
<TableLayout xmlns:android="http://schemas.android.com/apk/res/android"
    android:layout_width="fill_parent"
    android:layout_height="fill_parent">

    <TableRow>

        <TextView
            style="@style/label"
            android:text="@string/checkbox"/>

        <TextView
            android:id="@+id/checkbox"
            style="@style/value"/>
```

```
</TableRow>
<TableRow>
    <TextView
        style="@style/label"
        android:text="@string/ringtone"/>
    <TextView
        android:id="@+id/ringtone"
        style="@style/value"/>
</TableRow>
<TableRow>
    <TextView
        style="@style/label"
        android:text="@string/checkbox2"/>
    <TextView
        android:id="@+id/checkbox2"
        style="@style/value"/>
</TableRow>
<TableRow>
    <TextView
        style="@style/label"
        android:text="@string/text"/>
    <TextView
        android:id="@+id/text"
        style="@style/value"/>
</TableRow>
<TableRow>
    <TextView
        style="@style/label"
        android:text="@string/list"/>
    <TextView
        android:id="@+id/list"
        style="@style/value"/>
</TableRow>
</TableLayout>
```

The above layout is used by PreferenceContentsFragment, which populates the right-hand column of TextView widgets at runtime in onResume(), pulling the values from the default SharedPreferences for our application:

## USING PREFERENCES

---

```
package com.commonware.android.preffragsbc;

import android.content.SharedPreferences;
import android.os.Bundle;
import android.preference.PreferenceManager;
import android.view.LayoutInflater;
import android.view.View;
import android.view.ViewGroup;
import android.widget.TextView;
import com.actionbarsherlock.app.SherlockFragment;

public class PreferenceContentsFragment extends SherlockFragment {
    private TextView checkbox=null;
    private TextView ringtone=null;
    private TextView checkbox2=null;
    private TextView text=null;
    private TextView list=null;

    @Override
    public View onCreateView(LayoutInflater inflater, ViewGroup parent,
        Bundle savedInstanceState) {
        View result=inflater.inflate(R.layout.content, parent, false);

        checkbox=(TextView)result.findViewById(R.id.checkbox);
        ringtone=(TextView)result.findViewById(R.id.ringtone);
        checkbox2=(TextView)result.findViewById(R.id.checkbox2);
        text=(TextView)result.findViewById(R.id.text);
        list=(TextView)result.findViewById(R.id.list);

        return(result);
    }

    @Override
    public void onResume() {
        super.onResume();

        SharedPreferences prefs=
            PreferenceManager.getDefaultSharedPreferences(getActivity());

        checkbox.setText(new Boolean(prefs.getBoolean("checkbox",
false)).toString());
        ringtone.setText(prefs.getString("ringtone", "<unset>"));
        checkbox2.setText(new Boolean(prefs.getBoolean("checkbox2",
false)).toString());
        text.setText(prefs.getString("text", "<unset>"));
        list.setText(prefs.getString("list", "<unset>"));
    }
}
```

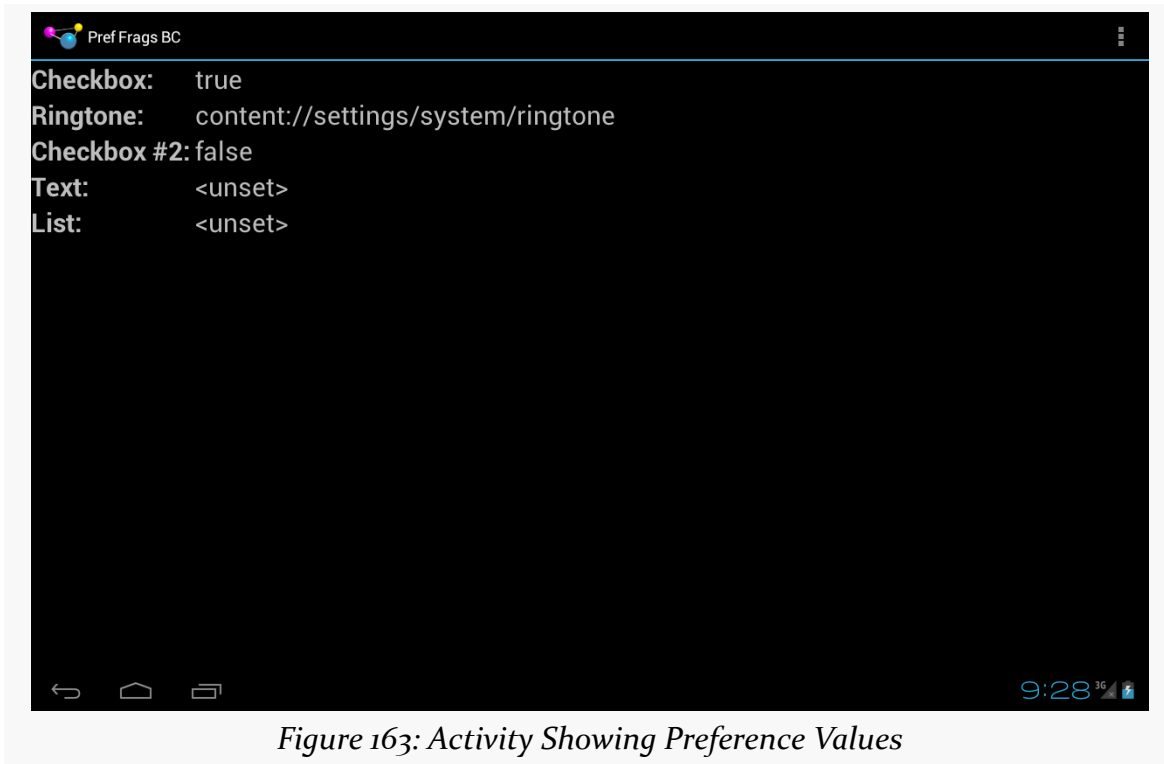
The main activity, `FragmentDemo`, simply loads `res/layout/main.xml`, which contains a `<fragment>` element pointing at `PreferenceContentsFragment`. It also defines an options menu, which we will examine later in this section.



## USING PREFERENCES

---

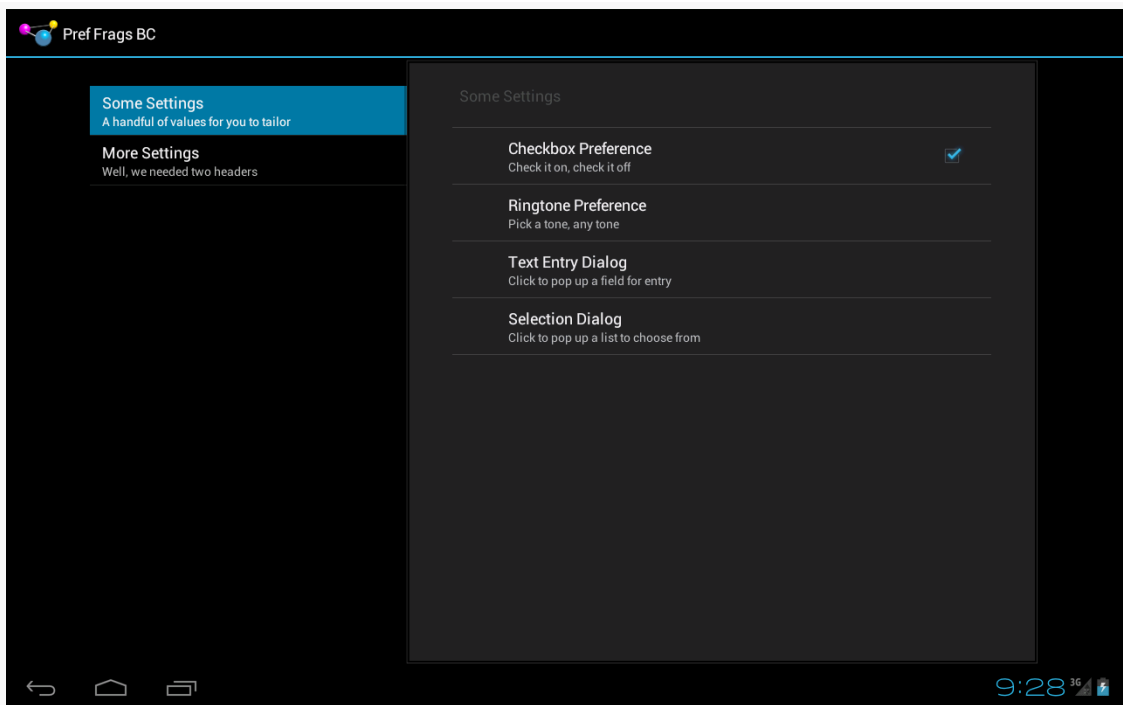
The result is an activity showing the default values of the preferences when it is first run, since we have not set any values yet:



*Figure 163: Activity Showing Preference Values*

We will also have two flavors of a `PreferenceActivity`, to collect the preferences from the user. Those preferences will be divided into two “preference headers”, following the two-pane preference UI adopted with Android 3.0:

## USING PREFERENCES

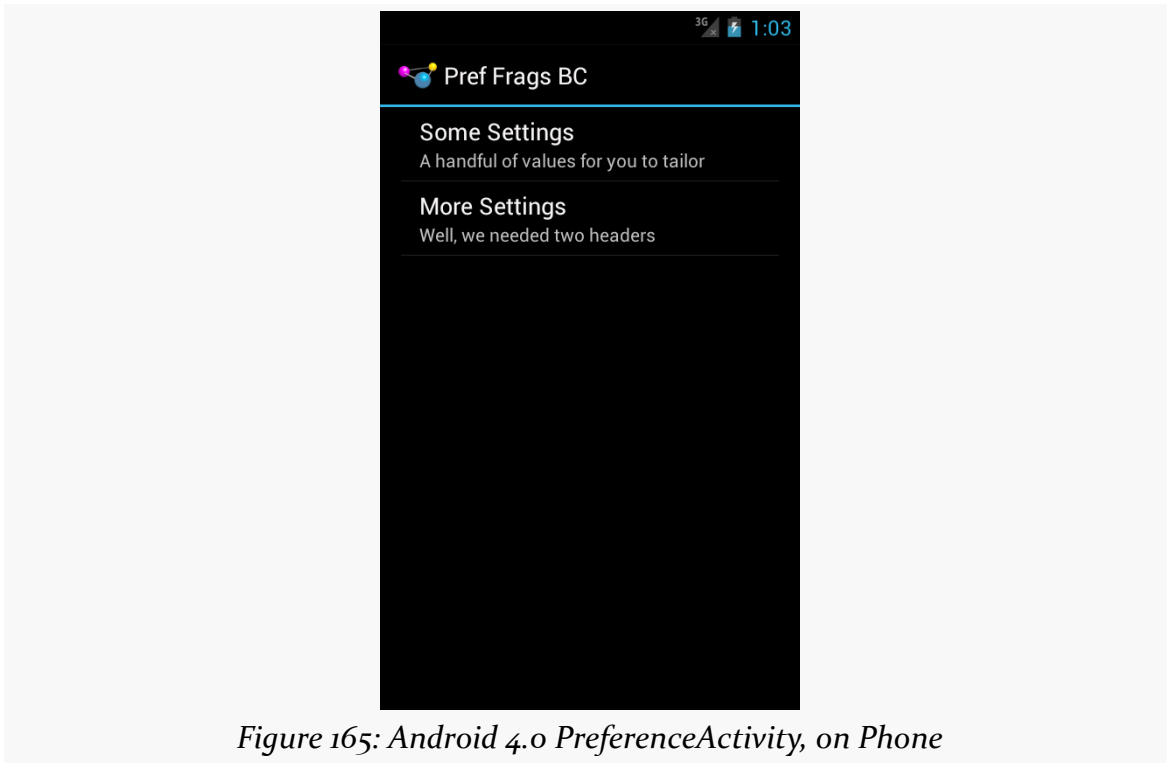


*Figure 164: Android 4.0 PreferenceActivity, on Tablet*

On a phone-sized screen, those panes become two separate screens, the first showing the list of headers:

## USING PREFERENCES

---

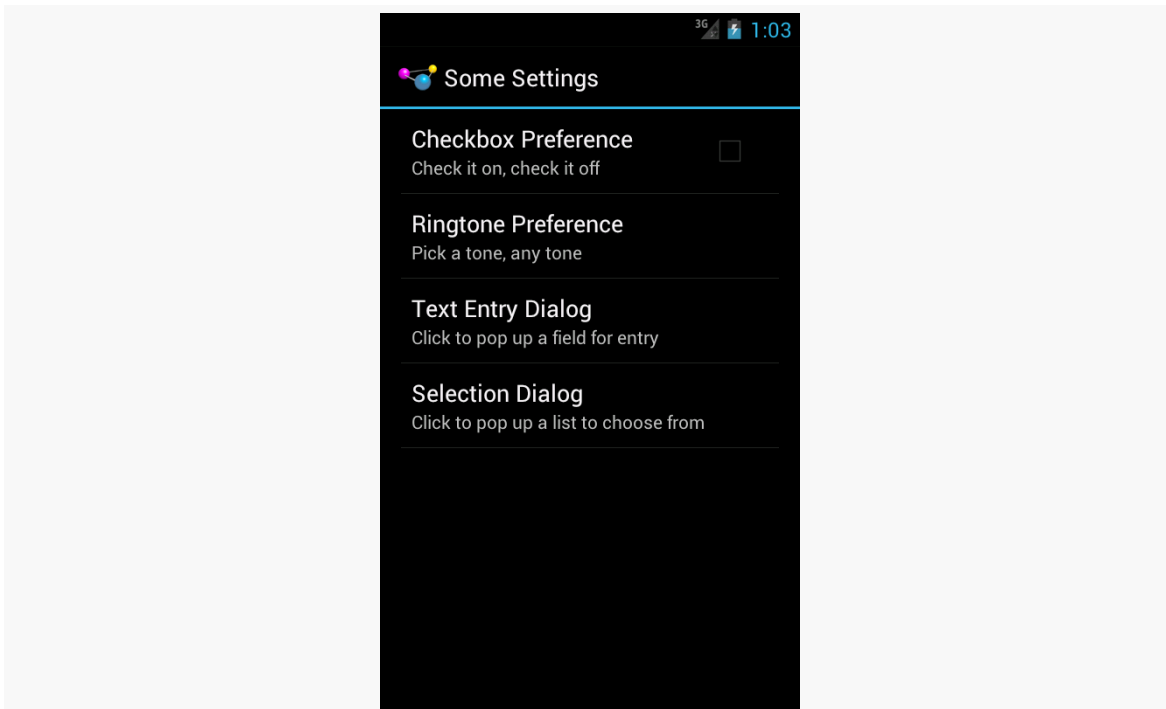


*Figure 165: Android 4.0 PreferenceActivity, on Phone*

and the second showing the contents of a specific header:

## USING PREFERENCES

---



*Figure 166: Android 4.0 PreferenceActivity, on Phone, Showing Second Preference Header*

On Android 1.x and 2.x, where preference headers do not exist, we will instead show all of the preferences in one long list:

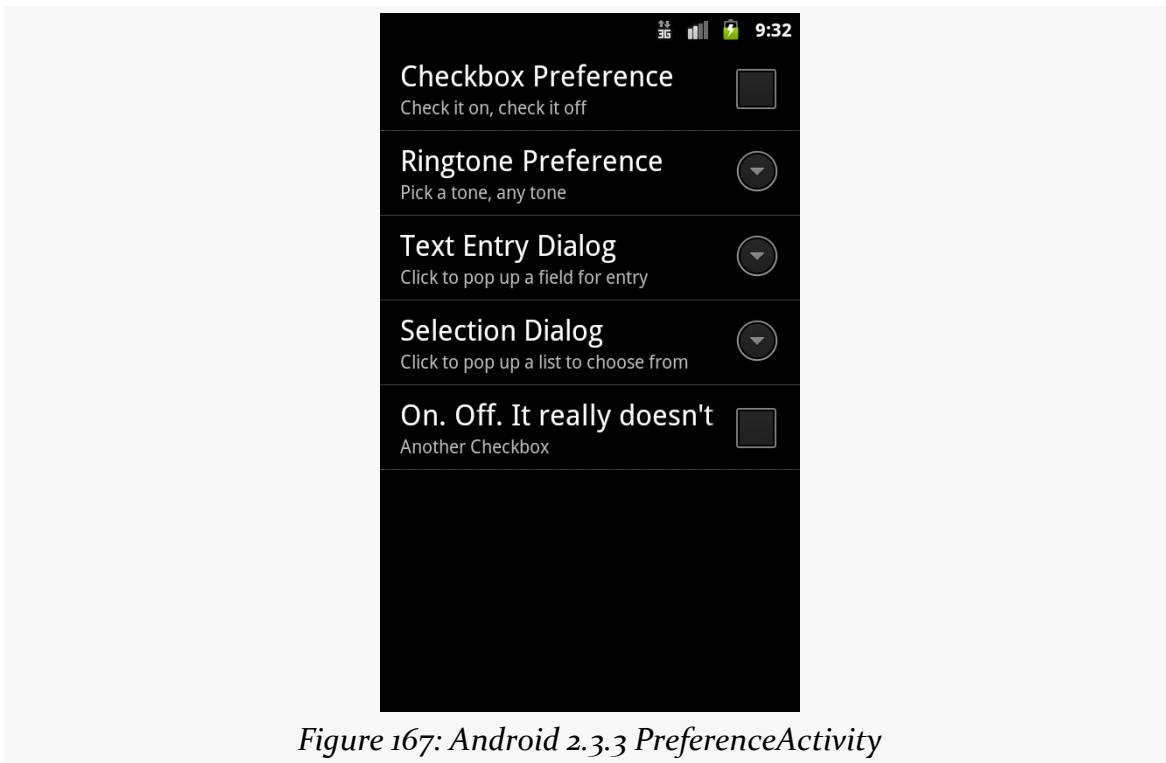


Figure 167: Android 2.3.3 PreferenceActivity

### Defining Your Preferences

First, you need to tell Android what preferences you are trying to collect from the user.

To do this, you will need to add a `res/xml/` directory to your project, if one does not already exist. Then, for each preference header, you will want an XML file in `res/xml/` to contain the definition of the preferences you want to appear in that header.

The root element of this XML file will be `<PreferenceScreen>`, and it will contain child elements, one per preference.

For example, here is the second preference header's preferences, from `res/xml/preference2.xml`:

```
<PreferenceScreen xmlns:android="http://schemas.android.com/apk/res/android">
  <CheckBoxPreference
    android:key="checkbox2"
    android:summary="@string/pref5summary"
    android:title="@string/pref5title" />
```

```
</PreferenceScreen>
```

There is a single `<CheckBoxPreference>` element inside the `<PreferenceScreen>`, allowing the user to toggle a boolean value via a `CheckBox` widget.

Each preference element has three attributes at minimum:

1. `android:key`, which is the key you use to look up the value in the `SharedPreferences` object via methods like `getInt()`
2. `android:title`, which is a few words identifying this preference to the user
3. `android:summary`, which is a short sentence explaining what the user is to supply for this preference

We will examine more preference elements [later in this chapter](#).

### Defining Your Preference Headers

There is another XML resource you will need to define, one containing details about your preference headers. In this sample project, that is found in `res/xml/preference_headers.xml`:

```
<preference-headers xmlns:android="http://schemas.android.com/apk/res/android">
  <header
    android:fragment="com.commonware.android.preffragsbc.StockPreferenceFragment"
    android:summary="@string/header1summary"
    android:title="@string/header1title">
    <extra
      android:name="resource"
      android:value="preferences"/>
  </header>
  <header
    android:fragment="com.commonware.android.preffragsbc.StockPreferenceFragment"
    android:summary="@string/header2summary"
    android:title="@string/header2title">
    <extra
      android:name="resource"
      android:value="preferences2"/>
  </header>
</preference-headers>
```

Here, your root element is `<preference-headers>`, containing a series of `<header>` elements. Each `<header>` contains at least three attributes:

## USING PREFERENCES

---

1. `android:fragment`, which identifies the Java class implementing the `PreferenceFragment` to use for this header, as is described in the next section
2. `android:title`, which is a few words identifying this header to the user
3. `android:summary`, which is a short sentence explaining what the user will find inside of this header

You can, if you wish, include one or more `<extra>` child elements inside the `<header>` element. These values will be put into the “arguments” `Bundle` that your `PreferenceFragment` can retrieve via `getArguments()`. In this sample code, each `<header>` has an `<extra>`, named `resource`, whose value is the base name of the XML file containing the preferences for that header — we will see what that is used for shortly.

### Creating Your PreferenceFragments

Preference XML, on API Level 11 and higher, is loaded by an implementation of `PreferenceFragment`. The mission of `PreferenceFragment` is to call `addPreferencesFromResource()` in `onCreate()`, supplying the resource ID of the preference XML to load for a particular preference header (e.g., `R.xml.preference2`).

There are two ways you can go about doing this. One is to create a dedicated `PreferenceFragment` subclass per preference header. The other is to create a single reusable `PreferenceFragment` implementation that can load up the preference XML for any preference header.

That is the approach we are using here in this sample application, via a stock `PreferenceFragment` implementation named, cunningly, `StockPreferenceFragment`:

```
package com.commonware.android.preffragsbc;

import android.os.Bundle;
import android.preference.PreferenceFragment;

public class StockPreferenceFragment extends PreferenceFragment {
    @Override
    public void onCreate(Bundle savedInstanceState) {
        super.onCreate(savedInstanceState);

        int res=
            getActivity().getResources()
                .getIdentifier(getArguments().getString("resource"),
                    "xml",
                    getActivity().getPackageName());
```

## USING PREFERENCES

---

```
        addPreferencesFromResource(res);  
    }  
}
```

`StockPreferenceFragment` does what it is supposed to: call `addPreferencesFromResource()` in `onCreate()` with the resource ID of the preferences to load. However, rather than hard-coding a resource ID, as we normally would, we look it up at runtime.

The `<extra>` elements in our preference header XML supply the name of the preference XML to be loaded. We get that name via the arguments `Bundle (getArguments().getString("resource"))`.

To look up a resource ID at runtime, we can use the `Resources` object, available from our activity via a call to `getResources()`. `Resources` has a method, `getIdentifier()`, that will return a resource ID given three pieces of information:

1. The base name of the resource (in our case, the value retrieved from the `<extra>` element)
2. The type of the resource (e.g., "xml")
3. The package holding the resource (in our case, our own package, retrieved from our activity via `getPackageName()`)

Note that `getIdentifier()` uses reflection to find this value, and so there is some overhead in the process. Do not use `getIdentifier()` in a long loop – cache the value instead.

The net is that `StockPreferenceFragment` loads the preference XML described in the `<extra>` element, so we do not need to create separate `PreferenceFragment` implementations per preference header.

### Creating Your PreferenceActivity

In an ideal world, the Android Support package would have an implementation of `PreferenceActivity` that uses preference headers and supports older versions of Android. In an ideal world, authors of Android books would have great hair. Hence, it is not an ideal world.

This causes some difficulty, insofar as API Level 11's `PreferenceActivity` would really like to use preference headers, and previous API levels do not support them at all.



## USING PREFERENCES

---

Hence, we have to get a bit creative in our own PreferenceActivity, here named EditPreferences:

```
package com.commonware.android.preffragsbc;

import java.util.List;
import android.os.Build;
import android.os.Bundle;
import com.actionbarsherlock.app.SherlockPreferenceActivity;

public class EditPreferences extends SherlockPreferenceActivity {
    @SuppressWarnings("deprecation")
    @Override
    public void onCreate(Bundle savedInstanceState) {
        super.onCreate(savedInstanceState);

        if (Build.VERSION.SDK_INT < Build.VERSION_CODES.HONEYCOMB) {
            addPreferencesFromResource(R.xml.preferences);
            addPreferencesFromResource(R.xml.preferences2);
        }

        @Override
        public void onBuildHeaders(List<Header> target) {
            loadHeadersFromResource(R.xml.preference_headers, target);
        }
    }
}
```

Our onCreate() entry point is called no matter what version of Android we are running on. However, for API Level 11+, there is a different callback, onBuildHeaders(), that we use to supply the preference headers, via a call to loadHeadersFromResource().

onBuildHeaders() will *only* be called on API Level 11 and higher. Hence, there is no danger in having that method exist on older devices — it will simply be ignored.

However, on older devices, we must arrange to set up the preferences some other way. The original way to define preferences for a PreferenceActivity was to call addPreferencesFromResource(), once for each preference XML file, identifying the preferences to load. Hence, we have a pair of addPreferencesFromResource() calls in onCreate() to load our preference XML.

However, we do *not* want to go through that code block if we are on API Level 11+, as we will wind up with duplicated preferences: one set from the addPreferencesFromResource() calls and one set from the onBuildHeaders() logic. Hence, we wrap the addPreferencesFromResource() calls in a version guard block. The android.os.Build class has an inner class named VERSION, which itself has a

static data member named `SDK_INT`, which returns the API level that the device is running. We can compare this to `Build.VERSION_CODES.HONEYCOMB` to see if we are on API Level 11 or something older, and *only* use `addPreferencesFromResource()` if we are on older devices.

We will see this version guard block technique in greater detail [in a later chapter](#).

But, the net result is that our `PreferenceActivity` loads up the preferences to show to the user, using the preference header style on API Level 11 and up, and using a single list of preferences on older versions of Android.

## Types of Preferences

There are a variety of subclasses of `Preference` in the Android SDK for use with `PreferenceActivity`. This section will outline the major ones as of Android 4.0.3.

### CheckBoxPreference and SwitchPreference

The sample application shown above has a pair of `CheckBoxPreference` elements, one per preference XML file. A `CheckBoxPreference` is an “inline” preference, in that the widget the user interacts with (in this case, a `CheckBox`) is part of the preference screen itself, rather than contained in a separate dialog.

`SwitchPreference` is functionally equivalent to `CheckBoxPreference`, insofar as both collect boolean values from the user. The difference is that `SwitchPreference` uses a `Switch` widget that the user slides left and right to toggle between “on” and “off” states.

### EditTextPreference

`EditTextPreference`, when tapped by the user, pops up a dialog that contains an `EditText` widget. You can configure this widget via attributes on the `<EditTextPreference>` element — in addition to standard preference attributes like `android:key`, you can include any attribute understood by `EditText`, such as `android:inputType`.

The value stored in the `SharedPreferences` is a string.

### RingtonePreference

RingtonePreference pops up a dialog with a list of ringtones installed on the device or emulator. However, note that the Android emulator does not come with any ringtones at the present time.

In addition to the standard preference attributes, you can include `android:showDefault`, indicating that the list should contain a “Default ringtone” option. If the user chooses this ringtone, they are effectively choosing the same ringtone that they have set up for incoming phone calls.

You can also use `android:showSilent`, which allows the user to choose a “Silence” pseudo-ringtone, to indicate not to play any ringtone.

For example, `res/xml/preferences.xml` from the sample project contains a RingtonePreference:

```
<RingtonePreference
    android:key="ringtone"
    android:showDefault="true"
    android:showSilent="true"
    android:summary="@string/pref2summary"
    android:title="@string/pref2title"/>
```

The value stored in the SharedPreferences is a string, specifically the string representation of a Uri pointing to a ContentProvider that can serve up the ringtone for playback. The use of ContentProvider will be covered [in a later chapter](#), and playing back media like ringtones will be covered [in another later chapter](#).

### ListPreference and MultiSelectListPreference

Visually, a ListPreference looks just like RingtonePreference, except that you control what goes into the list. You do this by specifying a pair of string-array resources in your preference XML.

String resources hold individual strings; string array resources hold a collection of strings. Typically, you will find string array resources in `res/values/arrays.xml` and related resource sets for translation. The `<string-array>` element has the `name` attribute to identify the resource, along with child `<item>` elements for the individual strings in the array.

## USING PREFERENCES

---

For example, the sample application profiled in this chapter has a pair of string array resources in `res/values/arrays.xml`:

```
<?xml version="1.0" encoding="utf-8"?>
<resources>
  <string-array name="cities">
    <item>Philadelphia</item>
    <item>Pittsburgh</item>
    <item>Allentown/Bethlehem</item>
    <item>Erie</item>
    <item>Reading</item>
    <item>Scranton</item>
    <item>Lancaster</item>
    <item>Altoona</item>
    <item>Harrisburg</item>
  </string-array>
  <string-array name="airport_codes">
    <item>PHL</item>
    <item>PIT</item>
    <item>ABE</item>
    <item>ERI</item>
    <item>RDG</item>
    <item>AVP</item>
    <item>LNS</item>
    <item>A00</item>
    <item>MDT</item>
  </string-array>
</resources>
```

One of these (`cities`) will be the values the user sees in the list, and is associated with our preference via the `android:entries` attribute. The other (`airport_codes`) will be the *corresponding* values stored in the `SharedPreferences` as a string, and is associated with our preference via the `android:entryValues` attribute:

```
<ListPreference
  android:dialogTitle="@string/listdialogtitle"
  android:entries="@array/cities"
  android:entryValues="@array/airport_codes"
  android:key="list"
  android:summary="@string/pref4summary"
  android:title="@string/pref4title"/>
```

We also use `android:dialogTitle` to provide the caption for the dialog:

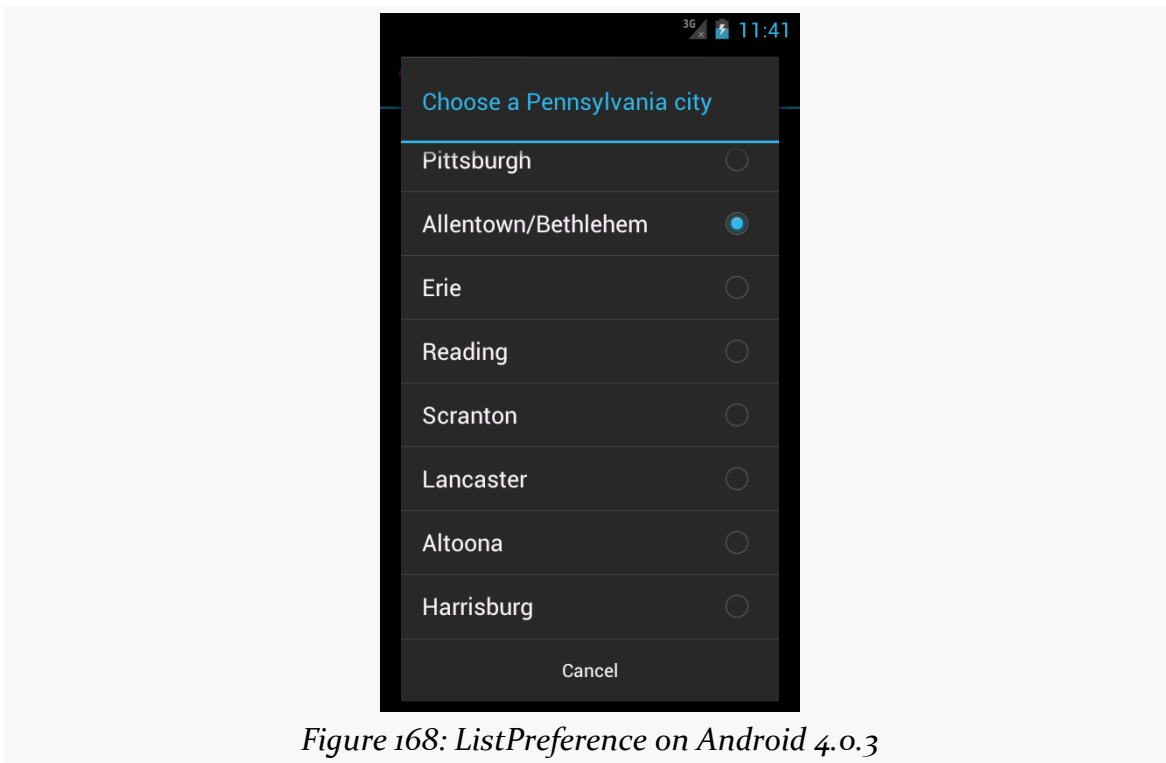


Figure 168: *ListPreference* on Android 4.0.3

When the user chooses a value (e.g., “Allentown/Bethlehem”), the corresponding value out of the other string array resource is stored in the `SharedPreferences` (e.g., “ABE”).

`MultiSelectListPreference` works much the same way, except:

- The list contains checkboxes, not radio buttons
- The user can check multiple items
- The result is stored in a “string set” in the `SharedPreferences`, retrieved via `getStringSet()`
- It is only available on API Level 11 and higher

## Intents for Headers or Preferences

If you have the need to collect some preferences that are beyond what the standard preferences can handle, you have some choices.

---

## USING PREFERENCES

---

One is to create a custom Preference. Extending `DialogPreference` to create your own Preference implementation is not especially hard. However, it does constrain you to something that can fit in a dialog.

Another option is to specify an `<intent>` element as a child of a `<header>` element. When the user taps on this header, your specified Intent is used with `startActivity()`, giving you a gateway to your own activity for collecting things that are beyond what the preference UI can handle. For example, you could have the following `<header>`:

```
<header android:icon="@drawable/something"
        android:title="Fancy Stuff"
        android:summary="Click here to transcend your
plane of existence">
  <intent android:action="com.commonware.android.MY_CUSTOM_ACTION" />
</header>
```

Then, so long as you have an activity with an `<intent-filter>` specifying your desired action (`com.commonware.android.MY_CUSTOM_ACTION`), that activity will get control when the user taps on the associated header.

## Conditional Headers

The two-tier, headers-and-preferences approach is fine and helps to organize large rosters of preferences. However, it does tend to steer developers in the direction of displaying headers *all of the time*. For many apps, that is rather pointless, because there are too few preferences to collect to warrant having more than one header.

One alternative approach is to use the headers on larger devices, but skip them on smaller devices. That way, the user does not have to tap past a single-item `ListFragment` just to get to the actual preferences to adjust.

This is a wee bit tricky to implement. However, you have two options for how to accomplish it.

(The author would like to thank Richard Le Mesurier, whose question on this topic spurred the development of this section and its samples)

### Option #1: Do Not Define the Headers

The basic plan in the first approach is to have smarts in `onBuildHeaders()` to handle this. `onBuildHeaders()` is the callback that Android invokes on our

## USING PREFERENCES

---

PreferenceActivity to let us define the headers to use in the master-detail pattern. If we want to have headers, we would supply them here; if we want to skip the headers, we would instead fall back to the classic (and, admittedly, deprecated) `addPreferencesFromResource()` method to load up some preference XML.

There is an `isMultiPane()` method on PreferenceActivity, starting with API Level 11, that will tell you if the activity will render with two fragments (master+detail) or not. In principle, this would be ideal to use. Unfortunately, it does not seem to be designed to be called from `onBuildHeaders()`. Similarly, `addPreferencesFromResource()` does not seem to be callable from `onBuildHeaders()`. Both are due to timing: `onBuildHeaders()` is called in the middle of the PreferenceActivity `onCreate()` processing.

So, we have to do some fancy footwork.

By examining [the source code to PreferenceActivity](#), you will see that the logic that drives the single-pane vs. dual-pane UI decision boils down to:

```
onIsHidingHeaders() || !onIsMultiPane()
```

If that expression returns true, we are in single-pane mode; otherwise, we are in dual-pane mode. `onIsHidingHeaders()` will normally return false, while `onIsMultiPane()` will return either true or false based upon screen size.

So, we can leverage this information in a PreferenceActivity to conditionally load our headers, as seen in the EditPreferences class in the [Prefs/SingleHeader](#) sample project:

```
package com.commonware.android.pref1header;

import java.util.List;
import android.os.Build;
import android.os.Bundle;
import com.actionbarsherlock.app.SherlockPreferenceActivity;

public class EditPreferences extends SherlockPreferenceActivity {
    private boolean needResource=false;

    @SuppressWarnings("deprecation")
    @Override
    public void onCreate(Bundle savedInstanceState) {
        super.onCreate(savedInstanceState);

        if (needResource
            || Build.VERSION.SDK_INT < Build.VERSION_CODES.HONEYCOMB) {
            addPreferencesFromResource(R.xml.preferences);
        }
    }
}
```

```
    }  
  }  
  
  @Override  
  public void onBuildHeaders(List<Header> target) {  
    if (onIsHidingHeaders() || !onIsMultiPane()) {  
      needResource=true;  
    }  
    else {  
      loadHeadersFromResource(R.xml.preference_headers, target);  
    }  
  }  
}
```

Here, if we are in dual-pane mode, `onBuildHeaders()` populates the headers as normal. If, though, we are in single-pane mode, we skip that step and make note that we need to do some more work in `onCreate()`.

Then, in `onCreate()`, if we did not load our headers, *or* if we are on API Level 10 or below, we use the classic `addPreferencesFromResource()` method.

The net result is that on Android 3.0+ tablets, we get the dual-pane, master-detail look with our one header, but on smaller devices (regardless of version), we roll straight to the preferences themselves.

## Option #2: Go Directly to the Fragment

The advantage of the above approach is that it works with Android's own logic of whether to display the master-detail fragments or just one at a time. However, that logic — the fact that `onIsHidingHeaders() || !onIsMultiPane()` determines the look of the activity — is not documented, and therefore may change in future Android releases.

Another option is to launch your `PreferenceActivity` in such a way that tells Android to skip showing the headers. On the plus side, this approach is better documented and therefore perhaps more stable. However, it requires you to have your own rules for whether or not the master-detail perspective is likely to be seen.

To see how this works, take a look at the [Prefs/SingleHeader2](#) sample project.

To determine whether or not we wish to show the preference headers, we use a boolean resource, `R.bool.suppressHeaders`, defined both in `res/values/bools.xml`:



## USING PREFERENCES

---

```
<resources>
  <bool name="suppressHeader">true</bool>
</resources>
```

and in `res/values-large/bools.xml`:

```
<resources>
  <bool name="suppressHeader">false</bool>
</resources>
```

Our `EditPreferences` class is the same implementation as in the original sample for this chapter, except that we only load up the single XML resource's worth of preferences:

```
package com.commonware.android.pref1header;

import java.util.List;
import android.os.Build;
import android.os.Bundle;
import com.actionbarsherlock.app.SherlockPreferenceActivity;

public class EditPreferences extends SherlockPreferenceActivity {
    @SuppressWarnings("deprecation")
    @Override
    public void onCreate(Bundle savedInstanceState) {
        super.onCreate(savedInstanceState);

        if (Build.VERSION.SDK_INT < Build.VERSION_CODES.HONEYCOMB) {
            addPreferencesFromResource(R.xml.preferences);
        }

        @Override
        public void onBuildHeaders(List<Header> target) {
            loadHeadersFromResource(R.xml.preference_headers, target);
        }
    }
}
```

However, there is a change in our main activity (`FragmentManager`). Before, when the user chose the “Settings” action bar overflow item, we would just call `startActivity()` to bring up `EditPreferences`. Now, we delegate that work to an `editPrefs()` method on `FragmentManager`, which will have the smarts to control *how* we bring up the `EditPreferences` activity:

```
private void editPrefs() {
    Intent i=new Intent(this, EditPreferences.class);
```

## USING PREFERENCES

---

```
if (Build.VERSION.SDK_INT >= Build.VERSION_CODES.HONEYCOMB
    && getResources().getBoolean(R.bool.suppressHeader)) {
    i.putExtra(PreferenceActivity.EXTRA_NO_HEADERS, true);
    i.putExtra(PreferenceActivity.EXTRA_SHOW_FRAGMENT,
        StockPreferenceFragment.class.getName());

    Bundle b=new Bundle();

    b.putString("resource", "preferences");

    i.putExtra(PreferenceActivity.EXTRA_SHOW_FRAGMENT_ARGUMENTS, b);
}

startActivity(i);
}
```

If we are on API Level 10 or below, where we do not have preference fragments, we start up `EditPreferences` as before. If `R.bool.suppressHeader` is false – as it will be on -large and -xlarge screens — we also start up `EditPreferences` as before. But, if `R.bool.suppressHeader` is true, then we will add three extras to our Intent:

- `EXTRA_NO_HEADERS`, set to true, to indicate that we do not want the headers to be displayed
- `EXTRA_SHOW_FRAGMENT`, set to the fully-qualified class name of the `PreferenceFragment` to be displayed, here obtained by calling `getName()` on the `Class` object for `StockPreferenceFragment`
- `EXTRA_SHOW_FRAGMENT_ARGUMENTS`, set to a `Bundle` containing the same values that would ordinarily be loaded from the `<extra>` elements in the preference header XML resource (in our case, the name of the preference XML resource to load)

Those three extras will be automatically handled by `PreferenceActivity` (on API Level 11+) and will have the effect of directly taking the user to our one-and-only fragment, bypassing the headers.



# **Tutorial #13 - Using Some Preferences**

Now that we have the core reading functionality working, we can start to add other features for the user.

One common thing in Android applications is to collect preferences from the user, tailoring the way the app behaves. In the case of EmPubLite, we will initially track two preferences:

- Whether the user wants to return to the book on the same chapter (page in the `ViewPager`) that they were on when they last were reading the book
- Whether the user wants us to keep the screen on, so they do not have to keep tapping the screen to prevent Android's automatic sleep mode from kicking in

In this tutorial, we will collect and use these two preferences.

This is a continuation of the work we did in [the previous tutorial](#).

You can find [the results of the previous tutorial](#) and [the results of this tutorial](#) in [the book's GitHub repository](#).

Note that if you are importing the previous code to begin work here, you will also need the [copy of ActionBarSherlock in this book's GitHub repository](#), and to make sure that your imported EmPubLite project references the ActionBarSherlock project as a library.

## Step #1: Adding a StockPreferenceFragment

In [the preceding chapter](#), we saw StockPreferenceFragment, which simply loads a <PreferenceScreen> bit of XML for us. This is simpler than rolling our own custom PreferenceFragment implementations, so let's use it.

If you wish to make this change using Eclipse's structured resource editor, follow the instructions in the "Eclipse" section below. Otherwise, follow the instructions in the "Outside of Eclipse" section (appears after the "Eclipse" section).

### Eclipse

Right click over the com.commonware.empublite package in the src/ folder of your project, and choose New > Class from the context menu. Fill in StockPreferenceFragment in the "Name" field. Click the "Browse..." button next to the "Superclass" field and find PreferenceFragment to set as the superclass. Then, click "Finish" on the new-class dialog to create the StockPreferenceFragment class.

Then, with StockPreferenceFragment open in the editor, paste in the following class definition:

```
package com.commonware.empublite;

import android.annotation.TargetApi;
import android.os.Bundle;
import android.preference.PreferenceFragment;

@TargetApi(11)
public class StockPreferenceFragment extends PreferenceFragment {
    @Override
    public void onCreate(Bundle savedInstanceState) {
        super.onCreate(savedInstanceState);

        int res=getActivity()
            .getResources()
            .getIdentifier(getArguments().getString("resource"),
                "xml",
                getActivity().getPackageName());

        addPreferencesFromResource(res);
    }
}
```

### Outside of Eclipse

Create a `src/com/commonsware/empublite/StockPreferenceFragment.java` source file, with the content shown above.

## Step #2: Defining the Preference XML Files

We need two XML files to define what preferences we wish to collect. One will define the preference headers (the left column of the two-pane tablet preference UI). The other will define the preferences that we wish to collect for the one header we will define.

If you wish to make this change using Eclipse's wizards and tools, follow the instructions in the "Eclipse" section below. Otherwise, follow the instructions in the "Outside of Eclipse" section (appears after the "Eclipse" section).

### Eclipse

Double-click on the `res/values/strings.xml` file in your Package Explorer. Use the "Add..." button to define a new string resource, with a name of `prefdesc` and a value of `Settings` for use of `EmPubLite`. Then, use the "Add..." button again to define another string resource, with a name of `preftitle` and a value of `Display and Navigation`. Repeat the process with four more string resources:

- `lastpositionsummary` = Save the last chapter you were viewing and open up on that chapter when re-opening the app
- `lastpositiontitle` = Save Last Position
- `keepscreenon_summary` = Keep the screen powered on while the reader is in the foreground
- `keepscreenon_title` = Keep Screen On

Right-click over the `res/` folder, and choose `New > Folder` from the context menu. Fill in `xml` as the folder name, then click "Finish" to create the folder.

Right-click over the `xml/` folder, and choose `New > File` from the context menu. Fill in `preference_headers.xml` as the name, then click "Finish" to create the file. Switch to the `preference_headers.xml` sub-tab of the newly-opened editor and paste in the following:

```
<preference-headers xmlns:android="http://schemas.android.com/apk/res/android">
```

## TUTORIAL #13 - USING SOME PREFERENCES

---

```
<header
  android:fragment="com.commonware.empublite.StockPreferenceFragment"
  android:summary="@string/prefdesc"
  android:title="@string/preftitle">
  <extra
    android:name="resource"
    android:value="pref_display"/>
</header>
</preference-headers>
```

Note that while the code listing may show the root element wrapping onto a second line, it really should be all on one line.

Right-click over the xml folder, and choose New > File from the context menu. Fill in pref\_display.xml as the name, then click “Finish” to create the file. Switch to the pref\_display.xml sub-tab of the newly-opened editor and paste in the following:

```
<PreferenceScreen xmlns:android="http://schemas.android.com/apk/res/android"
  xmlns:empub="http://schemas.android.com/apk/res-auto">

  <CheckBoxPreference
    android:defaultValue="false"
    android:key="saveLastPosition"
    android:summary="@string/lastpositionsummary"
    android:title="@string/lastpositiontitle"/>
  <CheckBoxPreference
    android:defaultValue="false"
    android:key="keepScreenOn"
    android:summary="@string/keepscreenon_summary"
    android:title="@string/keepscreenon_title"/>

</PreferenceScreen>
```

Note that while the code listing may show the root element wrapping onto a second line, it really should be all on one line.

### Outside of Eclipse

Add six new <string> elements to res/values/strings.xml:

```
<string name="prefdesc">Settings for use of EmPubLite</string>
<string name="preftitle">Display and Navigation</string>
<string name="lastpositiontitle">Save Last Position</string>
<string name="lastpositionsummary">Save the last chapter you were viewing and
open up on that chapter when re-opening the app</string>
<string name="keepscreenon_summary">Keep the screen powered on while the reader
is in the foreground</string>
<string name="keepscreenon_title">Keep Screen On</string>
```

Then, create a `res/xml/` directory in your project. In there, create a `preference_headers.xml` file with the XML from the first code listing in the “Eclipse” section above. Also create a `pref_display.xml` file with the XML from the second code listing in the “Eclipse” section above.

### Step #3: Creating Our PreferenceActivity

We now need an implementation of `SherlockPreferenceActivity` to load our preference XML, using just `pref_display.xml` on pre-API Level 11 devices and using the full set of XML on API Level 11+ devices. We will use an implementation nearly identical to the one shown in [the previous chapter](#).

If you wish to make this change using Eclipse’s wizards and tools, follow the instructions in the “Eclipse” section below. Otherwise, follow the instructions in the “Outside of Eclipse” section (appears after the “Eclipse” section).

#### Eclipse

Right click over the `com.commonware.empublite` package in the `src/` folder of your project, and choose `New > Class` from the context menu. Fill in Preferences in the “Name” field. Click the “Browse...” button next to the “Superclass” field and find `SherlockPreferenceActivity` to set as the superclass. Then, click “Finish” on the new-class dialog to create the Preferences class.

Then, with Preferences open in the editor, paste in the following class definition:

```
package com.commonware.empublite;

import java.util.List;
import android.os.Build;
import android.os.Bundle;
import com.actionbarsherlock.app.SherlockPreferenceActivity;

public class Preferences extends SherlockPreferenceActivity {
    @SuppressWarnings("deprecation")
    @Override
    public void onCreate(Bundle savedInstanceState) {
        super.onCreate(savedInstanceState);

        if (Build.VERSION.SDK_INT < Build.VERSION_CODES.HONEYCOMB) {
            addPreferencesFromResource(R.xml.pref_display);
        }
    }

    @Override
```



## TUTORIAL #13 - USING SOME PREFERENCES

---

```
public void onBuildHeaders(List<Header> target) {
    loadHeadersFromResource(R.xml.preference_headers, target);
}
}
```

Eclipse will complain about `addPreferencesFromResource()` being deprecated – despite the fact that we are only using it on older Android API levels – if we do not have the `@SuppressWarnings("deprecation")` annotation on the `onCreate()` method.

Then, open up `AndroidManifest.xml` in Eclipse and switch to the “Application” sub-tab. Scroll down to the “Application Nodes” list and click the “Add...” button, choosing to add a new activity. Click the “Browse...” button next to “Name” and pick the Preferences class. Then save your changes (e.g., `<Ctrl>-<S>`).

### Outside of Eclipse

Create a `src/com/commonsware/empublite/Preferences.java` source file, with the content shown above.

Also, add the following element as a child of the `<application>` element in your `AndroidManifest.xml` file:

```
<activity android:name="Preferences">
</activity>
```

## Step #4: Adding To Our Action Bar

Of course, having this activity does us no good if we cannot start it up, so we need to add another hook to our action bar configuration for that.

If you wish to make this change using Eclipse’s wizards and tools, follow the instructions in the “Eclipse” section below. Otherwise, follow the instructions in the “Outside of Eclipse” section (appears after the “Eclipse” section).

### Eclipse

Double-click on the `res/menu/options.xml` file in your project. Click the “Add...” button to add a new menu item. Give it the following details:

- Id of `@+id/settings`

## TUTORIAL #13 - USING SOME PREFERENCES

---

- Title of `@string/settings` (using the “Browse...” button to define a new string, with a value of Settings)
- Icon of `@android:drawable/ic_menu_preferences`
- “Show as action” of never

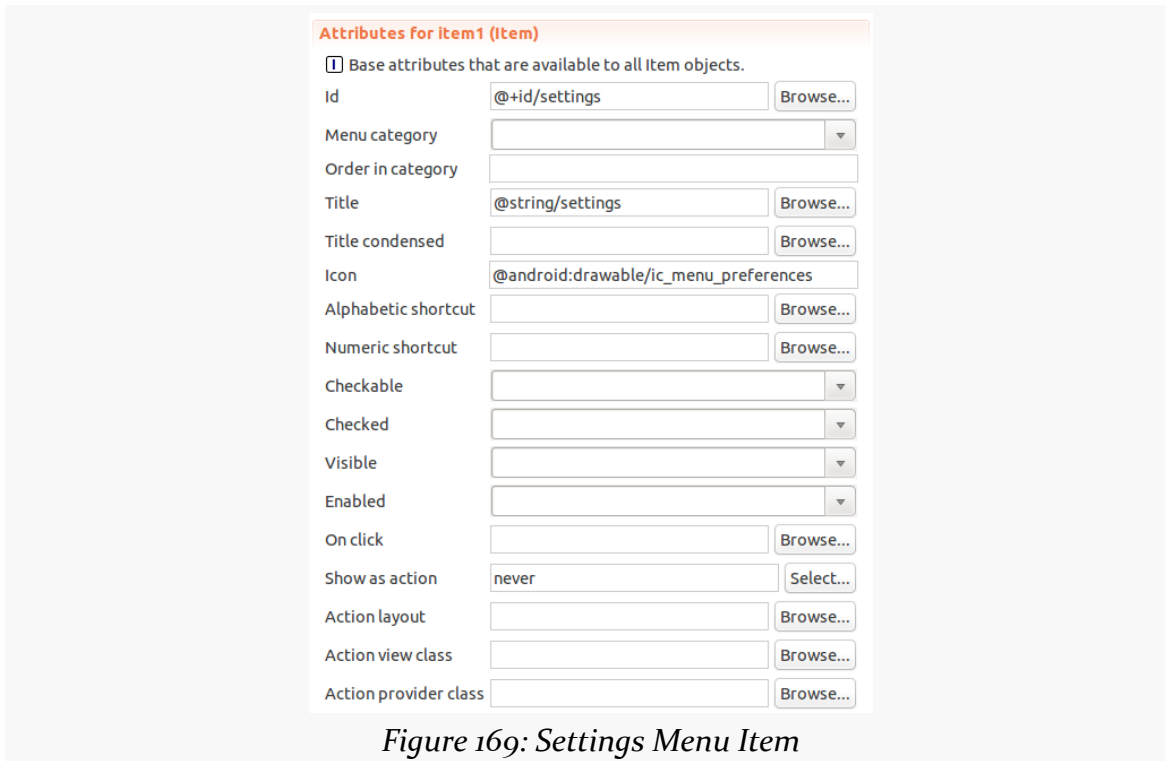


Figure 169: Settings Menu Item

Use the “Up” and “Down” buttons to move this new menu item to be the first one in the list.

### Outside of Eclipse

Add the following XML element to `res/menu/options.xml` as the first child of the `<menu>` root element:

```
<item
  android:id="@+id/settings"
  android:icon="@android:drawable/ic_menu_preferences"
  android:showAsAction="never"
  android:title="@string/settings">
</item>
```

You will also need to add a settings string resource, with a value of Settings.

## Step #5: Launching the PreferenceActivity

The only thing yet needed to allow the user to get to the preferences is to add another case to the switch() statement in onOptionsItemSelected() of EmPubLiteActivity:

```
case R.id.settings:  
    startActivity(new Intent(this, Preferences.class));  
    return(true);
```

Now, if you run this in an emulator or device, you will see the new option in the action bar overflow:

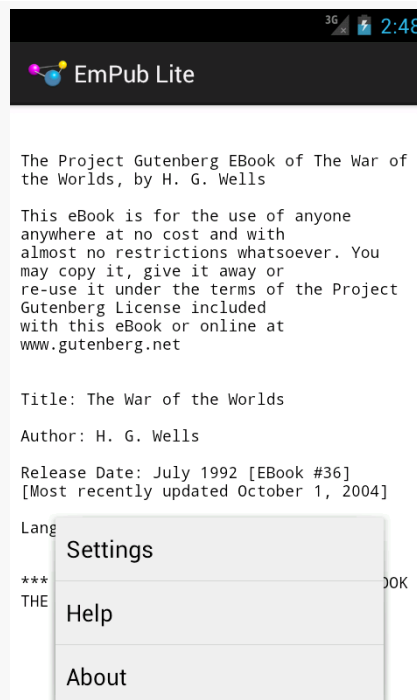
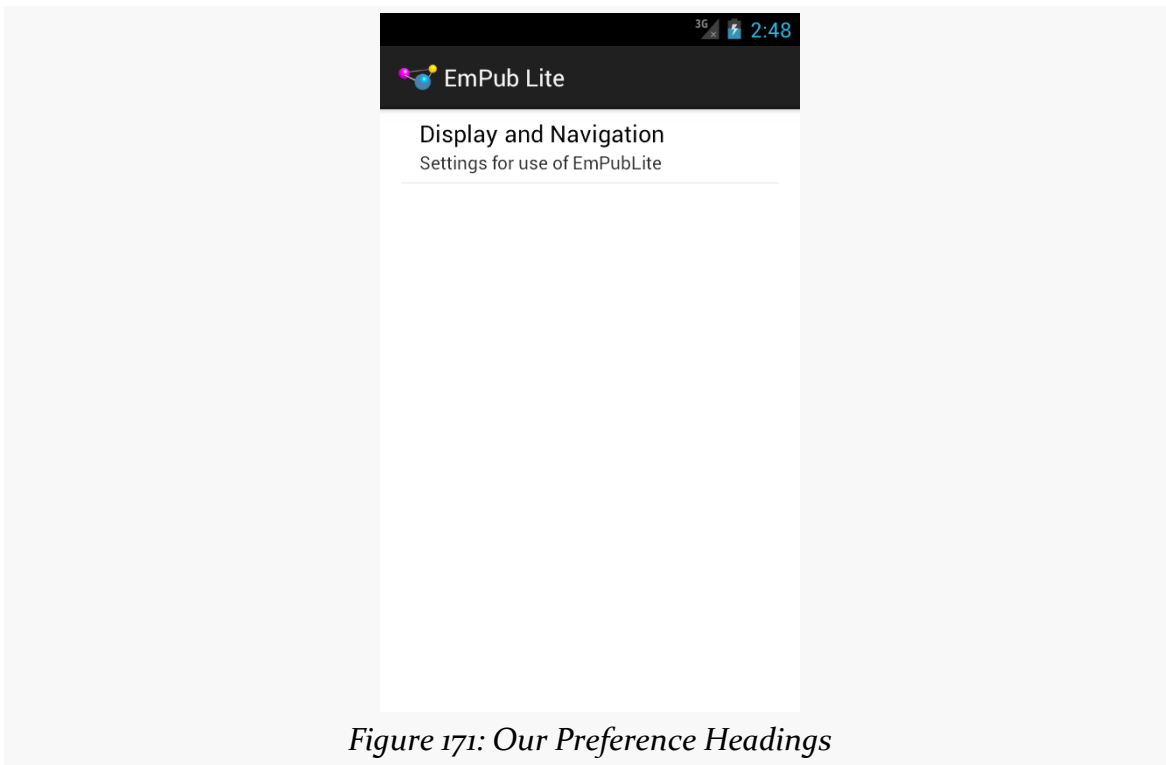


Figure 170: EmPubLite, With Revised Action Bar

Choosing the “Settings” option brings up the list of preference headings:

## TUTORIAL #13 - USING SOME PREFERENCES

---

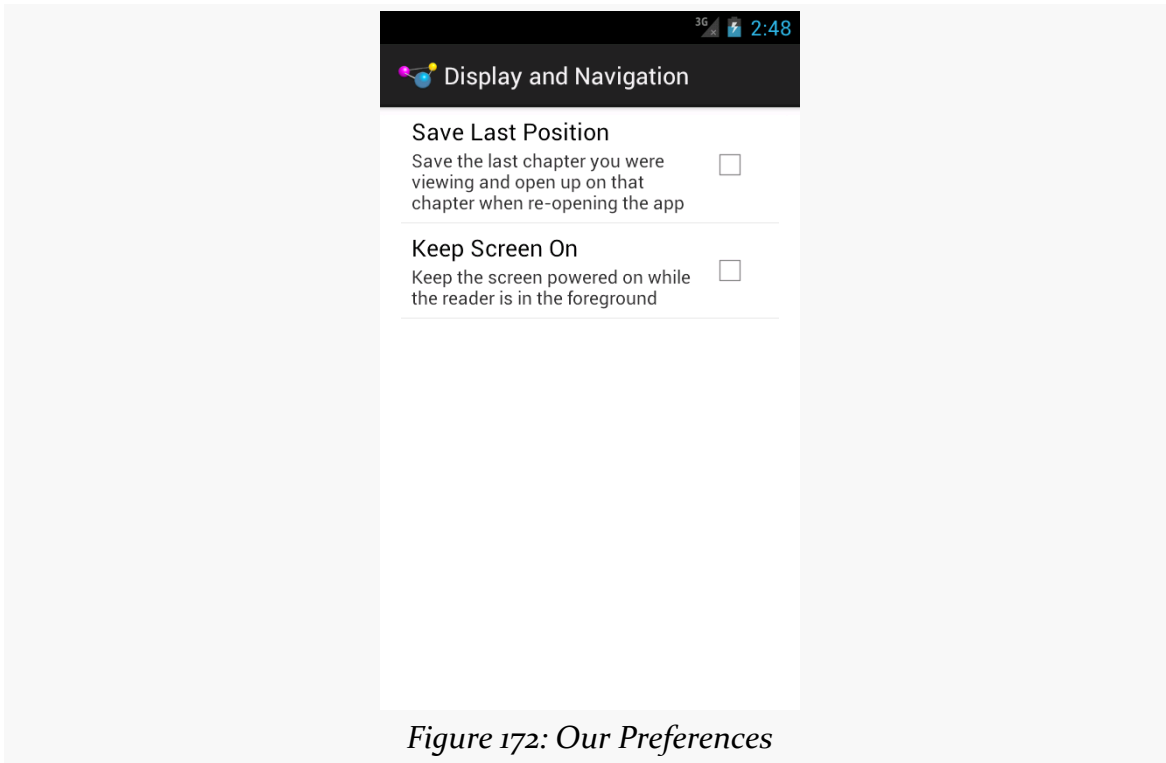


*Figure 171: Our Preference Headings*

Tapping on the “Display & Navigation” heading brings up our two preferences:

## TUTORIAL #13 - USING SOME PREFERENCES

---



On a tablet, we see the headings and the selected headings' worth of preferences at the same time:

## TUTORIAL #13 - USING SOME PREFERENCES



### Step #6: Loading Our Preferences

Collecting those preferences is one thing. Actually *using* them requires yet more work.

Our first step is to load our `SharedPreferences` object. This will read the persisted preferences and make them available to us for examination (and, as we will see, modification). Any changes made to those preferences — say, from the Preferences activity — will be automatically reflected in the loaded `SharedPreferences`.

However, since the persisted preferences are *persisted* — meaning that they are stored in a file — we need to try to load them in the background. Our `ModelFragment` already has some load-the-data-in-the-background logic, so we can extend that to set up the `SharedPreferences`.

Open up `ModelFragment` and add two more data members to the class:

```
private SharedPreferences prefs=null;
private PrefsLoadTask prefsTask=null;
```

## TUTORIAL #13 - USING SOME PREFERENCES

---

We will need to define that PrefsLoadTask as follows:

```
private class PrefsLoadTask extends AsyncTask<Context, Void, Void> {
    SharedPreferences localPrefs=null;

    @Override
    protected Void doInBackground(Context... ctxt) {
        localPrefs=PreferenceManager.getDefaultSharedPreferences(ctxt[0]);
        localPrefs.getAll();

        return(null);
    }

    @Override
    public void onPostExecute(Void arg0) {
        ModelFragment.this.prefs=localPrefs;
        ModelFragment.this.prefsTask=null;
        deliverModel();
    }
}
```

Here, we call `getDefaultSharedPreferences()` in `doInBackground()`. We also call `getAll()` on the `SharedPreferences` object, to make sure that it is fully loaded from disk, in case Android has an optimization that lazy-loads the preference data on first use. In `onPostExecute()`, we store the resulting `SharedPreferences` in a data member, clear our `prefsTask` data member (indicating that we are done with the load), and call `deliverModel()`.

The `deliverModel()` method will also need to be adjusted, to hand over the `SharedPreferences` to the `EmPubLiteActivity`:

```
synchronized private void deliverModel() {
    if (prefs != null && contents != null) {
        ((EmPubLiteActivity)getActivity()).setupPager(prefs, contents);
    }
    else {
        if (prefs == null && prefsTask == null) {
            prefsTask=new PrefsLoadTask();
            executeAsyncTask(prefsTask,
                getActivity().getApplicationContext());
        }

        if (contents == null && contentsTask == null) {
            contentsTask=new ContentsLoadTask();
            executeAsyncTask(contentsTask,
                getActivity().getApplicationContext());
        }
    }
}
```

## TUTORIAL #13 - USING SOME PREFERENCES

---

Here, we initialize either or both of our tasks if we do not have our data (e.g., when `deliverModel()` is first called), and we only pass the data to the activity when we have both the `BookContents` and the `SharedPreferences`.

Of course, `setupPager()` in `EmPubLiteActivity` needs to be updated to match:

```
void setupPager(SharedPreferences prefs, BookContents contents) {
    this.prefs=prefs;

    adapter=new ContentsAdapter(this, contents);
    pager.setAdapter(adapter);

    findViewById(R.id.progressBar1).setVisibility(View.GONE);
    findViewById(R.id.pager).setVisibility(View.VISIBLE);
}
```

This will require a `SharedPreferences` data member to be added to `EmPubLiteActivity` as well:

```
private SharedPreferences prefs=null;
```

### Step #7: Saving the Last-Read Position

The one preference is to restore our current page in the `ViewPager` when the user later re-opens the app. To make that work, we need to start saving the current page as the user leaves the app. And, we may as well use our freshly-minted `SharedPreferences` to store this value.

We need a key under which we will store this value in the `SharedPreferences`, so add a new static data member to `EmPubLiteActivity`:

```
private static final String PREF_LAST_POSITION="lastPosition";
```

Then, add the following implementation of `onPause()` to `EmPubLiteActivity`:

```
@Override
public void onPause() {
    if (prefs != null) {
        int position=pager.getCurrentItem();
        prefs.edit().putInt(PREF_LAST_POSITION, position).apply();
    }
    super.onPause();
}
```



---

## TUTORIAL #13 - USING SOME PREFERENCES

---

Here, we check to see that we have the `SharedPreferences` loaded — odds are that we do, but we cannot be certain. If we do have access to the `SharedPreferences`, we find out the current position within the `ViewPager` via `getCurrentItem()` (e.g., 0 for the first page). We then obtain a `SharedPreferences.Editor` and use it to save this position value in the `SharedPreferences`, keyed as `PREF_LAST_POSITION`, using `apply()` to persist the changes. Since this project has API Level 9 as the minimum SDK version, it is safe for us to use `apply()` instead of the older synchronous `commit()`.

### Step #8: Restoring the Last-Read Position

Now that we are saving this position data, we can start to use it.

Our preference XML has our key to the “Save Last Position” preference, but we need it in Java code as well, so add another static data member to `EmPubLiteActivity`:

```
private static final String PREF_SAVE_LAST_POSITION="saveLastPosition";
```

Add the following lines to `setUpPager()` in `EmPubLiteActivity`:

```
if (prefs.getBoolean(PREF_SAVE_LAST_POSITION, false)) {  
    pager.setCurrentItem(prefs.getInt(PREF_LAST_POSITION, 0));  
}
```

Here, we check to see if the user has enabled having us restore the last-saved position (defaulting to `false`). If the user has, we retrieve the last-saved position (defaulting to 0, or the first page), and call `setCurrentItem()` on the `ViewPager` to shift to that particular page.

If you run this in a device or emulator, check the “Save Last Position” preference checkbox, flip ahead a couple of chapters, exit the app via the `BACK` button, and go back into the app, you will see that you are taken back to the chapter you were last reading.

### Step #9: Keeping the Screen On

Our other preference is whether or not the screen should stay on, without user input, while we are reading the book. The bare-bones implementation of this requires just two lines of additional code.

## TUTORIAL #13 - USING SOME PREFERENCES

---

First, we need to define another static data member on `EmPubLiteActivity`, this time with the key for our keep-screen-on preference:

```
private static final String PREF_KEEP_SCREEN_ON="keepScreenOn";
```

Then, add one more line to `setupPager()` in `EmPubLiteActivity`:

```
pager.setKeepScreenOn(prefs.getBoolean(PREF_KEEP_SCREEN_ON, false));
```

`setKeepScreenOn()`, called on any `View`, will keep the screen lit and active without continuous user input, so long as that `View` is on the screen.

This approach is somewhat limited, in that we are only setting this during the call to `setupPager()`. If the user changes the preference value, that change would only take effect when the activity was restarted (e.g., user rotates the screen, user exits the app via `BACK` and returns later).

The simplest way for us to have this take more immediate effect is to realize that `EmPubLiteActivity` will be paused and stopped when the Preferences activity is on the screen, and will be started and resumed when the user is done adjusting preferences. So, we can simply override `onResume()` to also update the screen-on setting:

```
@Override
public void onResume() {
    super.onResume();
    if (prefs != null) {
        pager.setKeepScreenOn(prefs.getBoolean(PREF_KEEP_SCREEN_ON, false));
    }
}
```

Of course, we may not *have* the `SharedPreferences` yet, when the app is first starting up, so we avoid making any changes in that case.

If you run this on a device (note: *not* an emulator), you can play with this preference and see the changes in the screen's behavior.

## In Our Next Episode...

... we will allow the user to [write, save, and delete notes](#) for the currently-viewed chapter, using a database.



# SQLite Databases

---

Besides `SharedPreferences` and your own file structures, the third primary means of persisting data locally on Android is via SQLite. For many applications, SQLite is the app's backbone, whether it is used directly or via some third-party wrapper.

This chapter will focus on how you can directly work with SQLite to store relational data.

## Introducing SQLite

[SQLite](#) is a very popular embedded database, as it combines a clean SQL interface with a very small memory footprint and decent speed. Moreover, it is public domain, so everyone can use it. Lots of firms (Adobe, Apple, Google, Sun, Symbian) and open source projects (Mozilla, PHP, Python) all ship products with SQLite.

For Android, SQLite is “baked into” the Android runtime, so every Android application can create SQLite databases. Since SQLite uses a SQL interface, it is fairly straightforward to use for people with experience in other SQL-based databases. However, its native API is not JDBC, and JDBC might be too much overhead for a memory-limited device like a phone, anyway. Hence, Android programmers have a different API to learn — the good news being is that it is not that difficult.

This chapter will cover the basics of SQLite use in the context of working on Android. It by no means is a thorough coverage of SQLite as a whole. If you want to learn more about SQLite and how to use it in environments other than Android, a fine book is [The Definitive Guide to SQLite](#) by Michael Owens.

### Thinking About Schemas

SQLite is a typical relational database, containing tables (themselves consisting of rows and columns), indexes, and so on. Your application will need its own set of tables and so forth for holding whatever data you wish to hold. This structure is generally referred to as a “schema”.

It is likely that your schema will need to change over time. You might add new tables or columns in support of new features. Or, you might significantly reorganize your data structure and wind up dropping some tables while moving the data into new ones.

As a result, when you ship an update to your application to your users, not only will your Java code change, but the *expectations* of that Java code will change as well, with respect to what your database schema will look like. Version 1 of your app will use your original schema, but by the time you ship, say, version 5 of the app, you might need an adjusted schema.

Android has facilities to assist you with handling changing database schemas, mostly centered around the `SQLiteOpenHelper` class.

### Start with a Helper

`SQLiteOpenHelper` is designed to consolidate your code related to two very common problems:

1. What happens the very first time when your app is run on a device after it is installed? At this point, we do not yet have a database, and so you will need to create your tables, indexes, starter data, and so on.
2. What happens the very first time when an upgraded version of your app is run on a device, where the upgraded version is expecting a newer database schema? Your database will still be on the old schema from the older edition of the app. You will need to have a chance to alter the database schema to match the needs of the rest of your app.

`SQLiteOpenHelper` wraps up the logic to create and upgrade a database, per your specifications, as needed by your application. You will need to create a custom subclass of `SQLiteOpenHelper`, implementing three methods at minimum:

## SQLITE DATABASES

---

1. The constructor, chaining upward to the SQLiteOpenHelper constructor. This takes the Context (e.g., an Activity), the name of the database, an optional cursor factory (typically, just pass null), and an integer representing the version of the database schema you are using (typically start at 1 and increment from there).
2. onCreate(), called when there is no database and your app needs one, which passes you a SQLiteDatabase object, pointing at a newly-created database, that you use to populate with tables and initial data, as appropriate.
3. onUpgrade(), called when the schema version you are seeking does not match the schema version of the database, which passes you a SQLiteDatabase object and the old and new version numbers, so you can figure out how best to convert the database from the old schema to the new one.

To see how all this SQLite stuff works in practice, we will examine the [Database/Constants](#) sample application. This application pulls a bunch of gravitational constants from the SensorManager class, puts them in a database table, displays them in a SherlockListFragment, and allows the user to add new ones via the action bar.

First, we need a SQLiteOpenHelper subclass, here named DatabaseHelper.

The DatabaseHelper constructor chains to the superclass and supplies the name of the database (held in a DATABASE\_NAME static data member) and the version number of our database schema (held in SCHEMA):

```
public class DatabaseHelper extends SQLiteOpenHelper {
    private static final String DATABASE_NAME="constants.db";
    private static final int SCHEMA=1;
    static final String TITLE="title";
    static final String VALUE="value";
    static final String TABLE="constants";

    public DatabaseHelper(Context context) {
        super(context, DATABASE_NAME, null, SCHEMA);
    }
}
```

We also need an onCreate() method, which will be called and passed a SQLiteDatabase object when a database needs to be newly created. Below you will see the DatabaseHelper implementation of onCreate(), though we will get into how it is using the SQLiteDatabase object more later in this chapter:

```
@Override
public void onCreate(SQLiteDatabase db) {
```

## SQLITE DATABASES

---

```
try {
    db.beginTransaction();
    db.execSQL("CREATE TABLE constants (_id INTEGER PRIMARY KEY AUTOINCREMENT,
title TEXT, value REAL);");

    ContentValues cv=new ContentValues();

    cv.put(TITLE, "Gravity, Death Star I");
    cv.put(VALUE, SensorManager.GRAVITY_DEATH_STAR_I);
    db.insert("constants", TITLE, cv);

    cv.put(TITLE, "Gravity, Earth");
    cv.put(VALUE, SensorManager.GRAVITY_EARTH);
    db.insert("constants", TITLE, cv);

    cv.put(TITLE, "Gravity, Jupiter");
    cv.put(VALUE, SensorManager.GRAVITY_JUPITER);
    db.insert("constants", TITLE, cv);

    cv.put(TITLE, "Gravity, Mars");
    cv.put(VALUE, SensorManager.GRAVITY_MARS);
    db.insert("constants", TITLE, cv);

    cv.put(TITLE, "Gravity, Mercury");
    cv.put(VALUE, SensorManager.GRAVITY_MERCURY);
    db.insert("constants", TITLE, cv);

    cv.put(TITLE, "Gravity, Moon");
    cv.put(VALUE, SensorManager.GRAVITY_MOON);
    db.insert("constants", TITLE, cv);

    cv.put(TITLE, "Gravity, Neptune");
    cv.put(VALUE, SensorManager.GRAVITY_NEPTUNE);
    db.insert("constants", TITLE, cv);

    cv.put(TITLE, "Gravity, Pluto");
    cv.put(VALUE, SensorManager.GRAVITY_PLUTO);
    db.insert("constants", TITLE, cv);

    cv.put(TITLE, "Gravity, Saturn");
    cv.put(VALUE, SensorManager.GRAVITY_SATURN);
    db.insert("constants", TITLE, cv);

    cv.put(TITLE, "Gravity, Sun");
    cv.put(VALUE, SensorManager.GRAVITY_SUN);
    db.insert("constants", TITLE, cv);

    cv.put(TITLE, "Gravity, The Island");
    cv.put(VALUE, SensorManager.GRAVITY_THE_ISLAND);
    db.insert("constants", TITLE, cv);

    cv.put(TITLE, "Gravity, Uranus");
    cv.put(VALUE, SensorManager.GRAVITY_URANUS);
    db.insert("constants", TITLE, cv);
}
```

## SQLITE DATABASES

---

```
cv.put(TITLE, "Gravity, Venus");
cv.put(VALUE, SensorManager.GRAVITY_VENUS);
db.insert("constants", TITLE, cv);

db.setTransactionSuccessful();
}
finally {
    db.endTransaction();
}
}
```

Suffice it to say for the moment that it is creating a constants table and inserting several rows into it, all wrapped in a transaction.

We also need `onUpgrade()`... even though it should never be called right now:

```
@Override
public void onUpgrade(SQLiteDatabase db, int oldVersion,
    int newVersion) {
    throw new RuntimeException("How did we get here?");
}
```

After all, right now, we only have one version of our schema (1) and therefore will have no need to upgrade. If, in the future, we change `SCHEMA` to a higher value (e.g., 2), and we upgrade our app on a device that had previously been run with our earlier schema, *then* we will be called with `onUpgrade()`. We are passed the old and new schema versions, so we know what needs to be upgraded.

Bear in mind that users do not necessarily have to take on each of your application updates, and so you might find that a user skipped a schema version:

- You release an app on Monday, with schema version 1
- A user installs your app on Tuesday and runs it, creating a database via `onCreate()`
- You release an upgraded app on Wednesday, with schema version 2
- You release yet another upgrade on Thursday, with schema version 3
- The user installs your upgrade, now needing a schema version 3 database instead of the version 1 presently on the device, triggering a call to `onUpgrade()`

There are two other methods you can elect to override in your `SQLiteOpenHelper`, if you feel the need:



- You can override `onOpen()`, to get control when somebody opens this database. Usually, this is not required.
- Android 3.0 introduced `onDowngrade()`, which will be called if the code requests an older schema than what is in the database presently. This is the converse of `onUpgrade()` — if your version numbers differ, one of these two methods will be invoked. Since normally you are moving forward with updates, you can usually skip `onDowngrade()`.

### Employing Your Helper

To use your `SQLiteOpenHelper` subclass, create and hold onto an instance of it. Then, when you need a `SQLiteDatabase` object to do queries or data modifications, ask your `SQLiteOpenHelper` to `getReadableDatabase()` or `getWritableDatabase()`, depending upon whether or not you will be changing its contents.

For example, the `ConstantsFragment` from the sample app creates a `DatabaseHelper` instance in `onActivityCreated()` and holds onto it in a data member:

```
public class ConstantsFragment extends SherlockListFragment implements
    DialogInterface.OnClickListener {
    private DatabaseHelper db=null;

    @Override
    public void onActivityCreated(Bundle savedInstanceState) {
        super.onActivityCreated(savedInstanceState);

        setHasOptionsMenu(true);
        setRetainInstance(true);

        db=new DatabaseHelper(getActivity());
        new LoadCursorTask().execute();
    }
}
```

When you are done with the database (e.g., your activity is being closed), simply call `close()` on your `SQLiteOpenHelper` to release your connection, as `ConstantsFragment` does (among other things) in `onDestroy()`:

```
@Override
public void onDestroy() {
    super.onDestroy();

    ((CursorAdapter)getListAdapter()).getCursor().close();
    db.close();
}
```

### Where to Hold a Helper

For trivial apps, like the one profiled in this chapter, holding a `SQLiteOpenHelper` in a data member of your one-and-only activity is fine.

If, however, you have multiple components — such as multiple activities — all needing to use the database, you are much better served having a *singleton instance* of your `SQLiteOpenHelper`, compared to having each activity have its own instance.

The reason is threading.

You really should do your database I/O on background threads. Opening a database is cheap, but working with it (queries, inserts, etc.) is not. The `SQLiteDatabase` object managed by `SQLiteOpenHelper` is thread-safe... so long as all threads are using the same instance.

For singleton objects that depend upon a `Context`, like `SQLiteOpenHelper`, rather than create the object using a garden-variety `Context` like an `Activity`, you really should create it with an `Application`. There is a singleton instance of a `Context`, in the form of the `Application` subclass, created in your process moments after it is started. You can retrieve this singleton by calling `getApplicationContext()` on any other `Context`. The advantage of using `Application` is memory leaks: if you put a `SQLiteOpenHelper` in a singleton, and use, say, an `Activity` to create it, then the `Activity` might not be able to be garbage-collected, because the `SQLiteOpenHelper` keeps a strong reference to it. Since `Application` is itself a singleton (and, hence, is “pre-leaked”, so to speak), the risks of a memory leak diminish significantly.

So, instead of:

```
db=new DatabaseHelper(getActivity());
```

in a fragment, with `db` as a data member, you might have:

```
db=new DatabaseHelper(getActivity().getApplicationContext());
```

with `db` as a static data member, shared by multiple activities or other components. We will examine this pattern in greater detail later in this book.

## Getting Data Out

One popular thing to do with a database is to get data out of it. Android has a few ways you can execute a query on a SQLiteDatabase (from your SQLiteOpenHelper), along with some classes, like CursorAdapter, to help you use the results you get back.

### Your Query Options

In most cases, your simplest option for executing a query is to call `rawQuery()` on the SQLiteDatabase. This takes two parameters:

- A SQL SELECT statement (or anything else that returns a result set), optionally with `?` characters in the WHERE clause (or ORDER BY or similar clauses) representing parameters to be bound at runtime
- An optional String array of the parameters to be used to replace the `?` characters in the query

If you do not use the `?` position parameter syntax in your query, you are welcome to pass `null` as the second parameter to `rawQuery()`.

The nice thing about `rawQuery()` is that any valid SQL syntax works, so long as it returns a result set. You are welcome to use joins, sub-selects, and so on without issue.

There are two other query options — `query()` and `SQLiteQueryBuilder`. These both build up a SQL SELECT statement from its component parts (e.g., name of the table to query, WHERE clause and positional parameters). These are more cumbersome to use, particularly with complex SELECT statements. Mostly, they would be used in cases where, for one reason or another, you do not know the precise query at compile time and find it easier to use these facilities to construct the query from parts at runtime.

For example, ConstantsFragment has a `doQuery()` method that uses `rawQuery()`:

```
private Cursor doQuery() {
    return(db.getReadableDatabase().rawQuery("SELECT _id, title, value "
                                             + "FROM constants ORDER BY
title",
                                             null));
}
```

### What Is a Cursor?

All three of these give you a Cursor when you are done. In Android, a Cursor represents the entire result set of the query — all the rows and all the columns that the query returned. In this respect, it is reminiscent of a “client-side cursor” from toolkits like ODBC, JDBC, etc.

As such, a Cursor can be quite the memory hog. Please `close()` the Cursor when you are done with it, to free up the heap space it consumes and make that memory available to the rest of your application.

### Using the Cursor Manually

With the Cursor, you can:

1. Find out how many rows are in the result set via `getCount()`
2. Iterate over the rows via `moveToFirst()`, `moveToNext()`, and `isAfterLast()`
3. Find out the names of the columns via `getColumnNames()`, convert those into column numbers via `getColumnIndex()`, and get values for the current row for a given column via methods like `getString()`, `getInt()`, etc.

For example, here we iterate over a fictitious `widgets` table’s rows:

```
Cursor result=
    db.rawQuery("SELECT _id, name, inventory FROM widgets", null);

while (result.moveToNext()) {
    int id=result.getInt(0);
    String name=result.getString(1);
    int inventory=result.getInt(2);

    // do something useful with these
}

result.close();
```

### Introducing CursorAdapter

Another way to use a Cursor is to wrap it in a CursorAdapter. Just as ArrayAdapter adapts arrays, CursorAdapter adapts Cursor objects, making their data available to an AdapterView like a ListView.

## SQLITE DATABASES

---

The easiest way to set one of these up is to use `SimpleCursorAdapter`, which extends `CursorAdapter` and provides some boilerplate logic for taking values out of columns and putting them into row View objects for a `ListView` (or other `AdapterView`). The sample app does just that:

```
@SuppressWarnings("deprecation")
@Override
public void onPostExecute(Void arg0) {
    SimpleCursorAdapter adapter;

    if (Build.VERSION.SDK_INT >= Build.VERSION_CODES.HONEYCOMB) {
        adapter = new SimpleCursorAdapter(getActivity(), R.layout.row,
            constantsCursor, new String[] {
                DatabaseHelper.TITLE,
                DatabaseHelper.VALUE },
            new int[] { R.id.title, R.id.value },
            0);
    }
    else {
        adapter = new SimpleCursorAdapter(getActivity(), R.layout.row,
            constantsCursor, new String[] {
                DatabaseHelper.TITLE,
                DatabaseHelper.VALUE },
            new int[] { R.id.title, R.id.value });
    }

    setListAdapter(adapter);
}
```

Here, we are telling `SimpleCursorAdapter` to take rows out of a `Cursor` named `constantsCursor`, turning each into an inflated `R.layout.row` `ViewGroup`, in this case, a `RelativeLayout` holding a pair of `TextView` widgets:

```
<?xml version="1.0" encoding="utf-8"?>
<RelativeLayout xmlns:android="http://schemas.android.com/apk/res/android"
    android:layout_width="fill_parent"
    android:layout_height="wrap_content">

    <TextView
        android:id="@+id/title"
        android:layout_width="wrap_content"
        android:layout_height="wrap_content"
        android:layout_alignParentLeft="true"
        android:textSize="20sp"
        android:textStyle="bold"/>

    <TextView
        android:id="@+id/value"
        android:layout_width="wrap_content"
        android:layout_height="wrap_content"
        android:layout_alignParentRight="true">
```

```
android:textSize="20sp"  
android:textStyle="bold"/>
```

```
</RelativeLayout>
```

For each row in the Cursor, the columns named `title` and `value` (represented by `TITLE` and `VALUE` constants on `DatabaseHelper`) are to be poured into their respective `TextView` widgets (`R.id.title` and `R.id.value`).

We use two different versions of the `SimpleCursorAdapter` constructor because one was deprecated in API Level 11. We use the `Build` class to detect which API level we are on and choose the right constructor accordingly. We will go into this technique in greater detail [in a later chapter](#).

Note, though, that if you are going to use `CursorAdapter` or its subclasses (like `SimpleCursorAdapter`), your result set of your query *must* contain an integer column named `_id` that is unique for the result set. This “id” value is then supplied to methods like `onListItemClick()`, to identify what item the user clicked upon in the `AdapterView`. Note that this requirement is on the result set in the `Cursor`, so if you have a suitable column in a table that is not named `_id`, you can rename it in your query (e.g., `SELECT key AS _id, ...`).

Also note that you cannot `close()` the `Cursor` used by a `CursorAdapter` until you no longer need the `CursorAdapter`. That is why we do not close the `Cursor` until `onDestroy()` of the fragment:

```
@Override  
public void onDestroy() {  
    super.onDestroy();  
  
    ((CursorAdapter)getListAdapter()).getCursor().close();  
    db.close();  
}
```

We retrieve the `Cursor` from the `CursorAdapter`, which we get by calling `getListAdapter()` on the fragment.

### Getting Data Out, Asynchronously

Ideally, queries are done on a background thread, as they may take some time.

One approach for doing that is to use an `AsyncTask`. In the sample application, `ConstantsFragment` kicks off a `LoadCursorTask` in `onActivityCreated()` (shown

## SQLITE DATABASES

---

above). LoadCursorTask is responsible for doing the query (via the doQuery() method shown above) and putting the results in the ListView inside the fragment:

```
private class LoadCursorTask extends AsyncTask<Void, Void, Void> {
    private Cursor constantsCursor=null;

    @Override
    protected Void doInBackground(Void... params) {
        constantsCursor=doQuery();
        constantsCursor.getCount();

        return(null);
    }

    @SuppressWarnings("deprecation")
    @Override
    public void onPostExecute(Void arg0) {
        SimpleCursorAdapter adapter;

        if (Build.VERSION.SDK_INT>=Build.VERSION_CODES.HONEYCOMB) {
            adapter=new SimpleCursorAdapter(getActivity(), R.layout.row,
                constantsCursor, new String[] {
                    DatabaseHelper.TITLE,
                    DatabaseHelper.VALUE },
                new int[] { R.id.title, R.id.value },
                0);
        }
        else {
            adapter=new SimpleCursorAdapter(getActivity(), R.layout.row,
                constantsCursor, new String[] {
                    DatabaseHelper.TITLE,
                    DatabaseHelper.VALUE },
                new int[] { R.id.title, R.id.value });
        }

        setListAdapter(adapter);
    }
}
```

We execute the actual query in doInBackground(), holding onto it in a data member of the LoadCursorTask. We also call getCount() on the Cursor, to force it to actually perform the query — rawQuery() returns the Cursor, but the query is not actually executed until we do something that needs the result set.

onPostExecute() then wraps it in a SimpleCursorAdapter and attaches it to the ListView via setListAdapter() on our SherlockListFragment.

This way, the UI will not be frozen while the query is being executed, yet we only update the UI from the main application thread.

Also note that the first time we try using the `SQLiteOpenHelper` is in our background thread. `SQLiteOpenHelper` will not try creating our database (e.g., for a new app install) until we call `getReadableDatabase()` or `getWritableDatabase()`. Hence, `onCreate()` (or, later, `onUpgrade()`) of our `SQLiteOpenHelper` will wind up being called on the background thread as well, meaning that the time spent creating (or upgrading) the database also does not freeze the UI.

## The Rest of the CRUD

To get data out of a database, it is generally useful to put data into it in the first place. The sample app starts by loading in data when the database is created (in `onCreate()` of `DatabaseHelper`), plus has an action bar item to allow the user to add other constants as needed.

In this section, we will examine in further detail how we manipulate the database, for both the write aspects of CRUD (create-read-update-delete) and for DDL operations (creating tables, creating indexes, etc.).

### The Primary Option: `execSQL()`

For creating your tables and indexes, you will need to call `execSQL()` on your `SQLiteDatabase`, providing the DDL statement you wish to apply against the database. Barring a database error, this method returns nothing.

So, for example, you can call `execSQL()` to create the constants table, as shown in the `DatabaseHelper` `onCreate()` method:

```
db.execSQL("CREATE TABLE constants (_id INTEGER PRIMARY KEY AUTOINCREMENT, title TEXT, value REAL);");
```

This will create a table, named `constants`, with a primary key column named `_id` that is an auto-incremented integer (i.e., SQLite will assign the value for you when you insert rows), plus two data columns: `title` (text) and `value` (a float, or “real” in SQLite terms). SQLite will automatically create an index for you on your primary key column — you could add other indexes here via some `CREATE INDEX` statements, if you so chose to.

Most likely, you will create tables and indexes when you first create the database, or possibly when the database needs upgrading to accommodate a new release of your application. If you do not change your table schemas, you might never drop your



tables or indexes, but if you do, just use `execSQL()` to invoke `DROP INDEX` and `DROP TABLE` statements as needed.

### Alternative Options

For inserts, updates, and deletes of data, you have two choices. You can always use `execSQL()`, just like you did for creating the tables. The `execSQL()` method works for any SQL that does not return results, so it can handle `INSERT`, `UPDATE`, `DELETE`, etc. just fine.

Your alternative is to use the `insert()`, `update()`, and `delete()` methods on the `SQLiteDatabase` object, which eliminate much of the SQL syntax required to do basic operations.

For example, here we `insert()` a new row into our `constants` table, again from `onCreate()` of `DatabaseHelper`:

```
ContentValues cv=new ContentValues();  
  
cv.put(TITLE, "Gravity, Death Star I");  
cv.put(VALUE, SensorManager.GRAVITY_DEATH_STAR_I);  
db.insert("constants", TITLE, cv);
```

These methods make use of `ContentValues` objects, which implement a `Map`-esque interface, albeit one that has additional methods for working with `SQLite` types. For example, in addition to `get()` to retrieve a value by its key, you have `getAsInteger()`, `getAsString()`, and so forth.

The `insert()` method takes the name of the table, the name of one column as the “null column hack”, and a `ContentValues` with the initial values you want put into this row. The “null column hack” is for the case where the `ContentValues` instance is empty — the column named as the “null column hack” will be explicitly assigned the value `NULL` in the SQL `INSERT` statement generated by `insert()`. This is required due to a quirk in `SQLite`’s support for the SQL `INSERT` statement.

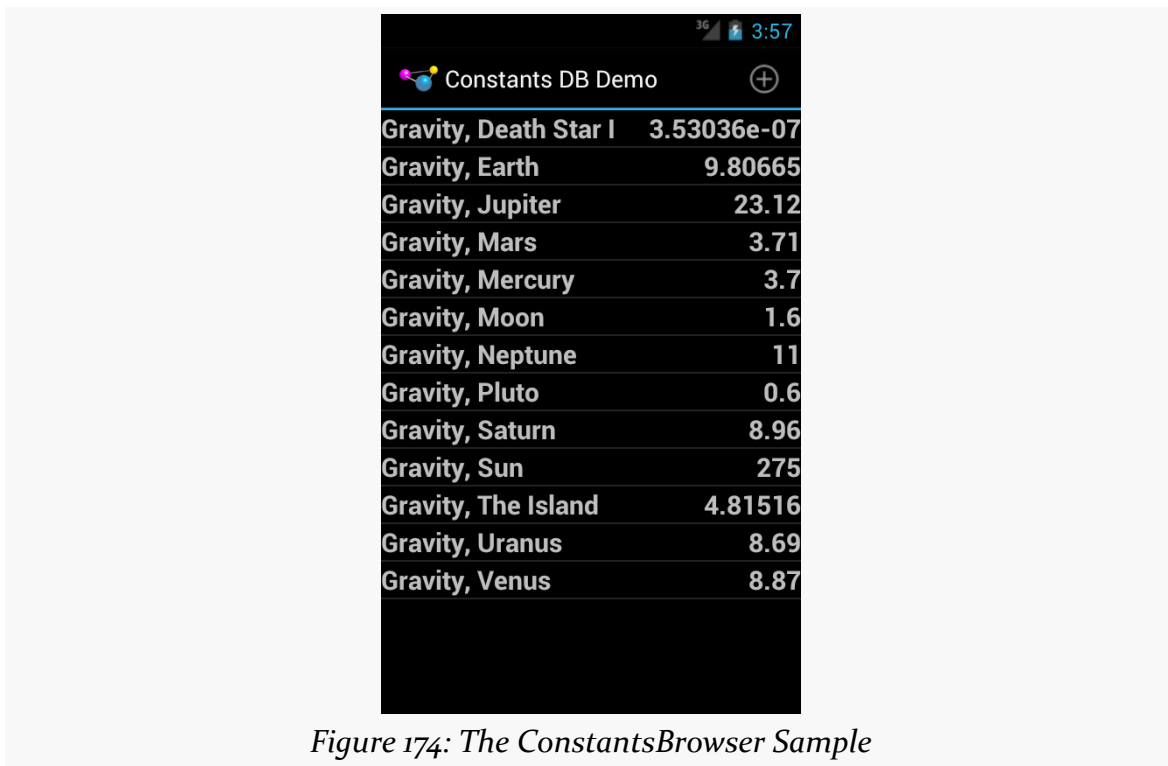
The `update()` method takes the name of the table, a `ContentValues` representing the columns and replacement values to use, an optional `WHERE` clause, and an optional list of parameters to fill into the `WHERE` clause, to replace any embedded question marks (?). Since `update()` only replaces columns with fixed values, versus ones computed based on other information, you may need to use `execSQL()` to accomplish some ends. The `WHERE` clause and parameter list works akin to the positional SQL parameters you may be used to from other SQL APIs.

The `delete()` method works akin to `update()`, taking the name of the table, the optional `WHERE` clause, and the corresponding parameters to fill into the `WHERE` clause.

### Asynchronous CRUD and UI Updates

Just as querying a database should be done on a background thread, so should modifying a database. This is why it is important to make the first time you request a `SQLiteDatabase` from a `SQLiteOpenHelper` be on a background thread, in case `onCreate()` or `onUpgrade()` are needed.

The same thing holds true if you need to update the database during normal operation of your app. For example, the sample application has an “add” action bar item in the upper-right corner of the screen:



Clicking on that brings up a dialog — a technique we will discuss later in this book:

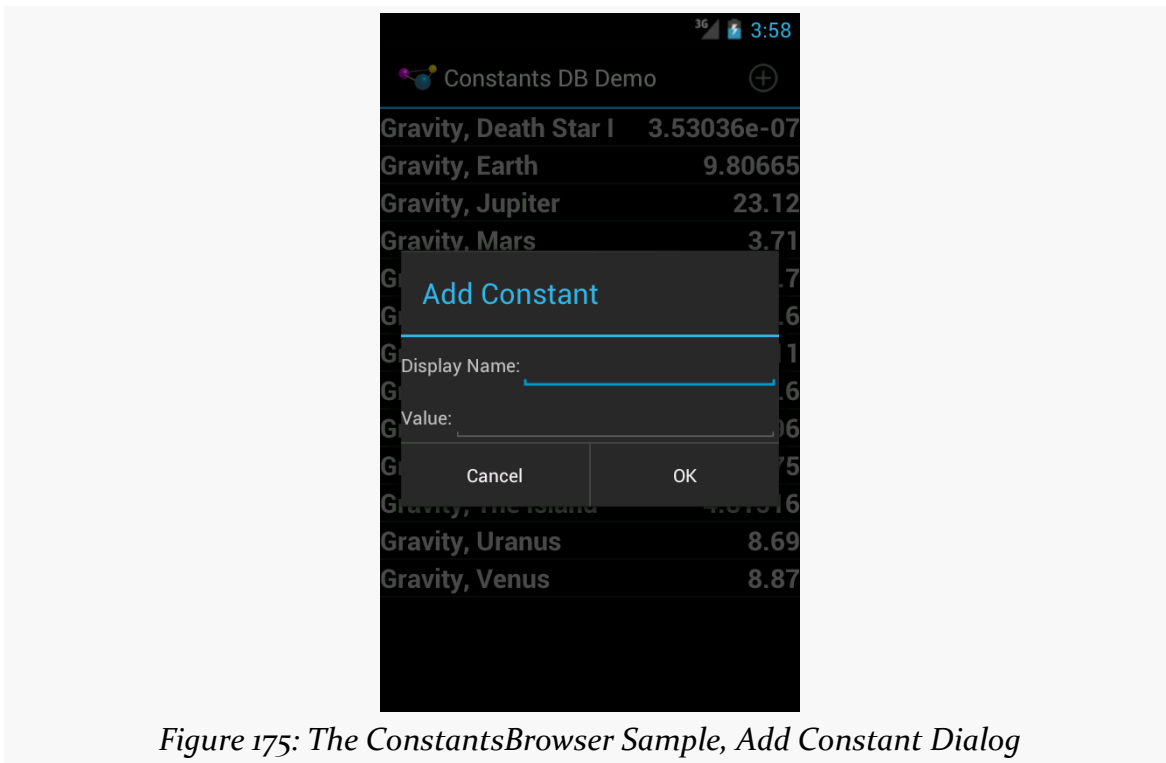


Figure 175: The ConstantsBrowser Sample, Add Constant Dialog

If the user fills in a constant and clicks the “OK” button, we need to insert a new record in the database. That is handled via an `InsertTask`:

```
private class InsertTask extends AsyncTask<ContentValues, Void, Void> {
    private Cursor constantsCursor=null;

    @Override
    protected Void doInBackground(ContentValues... values) {
        db.getWritableDatabase().insert(DatabaseHelper.TABLE,
                                       DatabaseHelper.TITLE, values[0]);

        constantsCursor=doQuery();
        constantsCursor.getCount();

        return(null);
    }

    @Override
    public void onPostExecute(Void arg0) {
        ((CursorAdapter)getListAdapter()).changeCursor(constantsCursor);
    }
}
```

The `InsertTask` is supplied a `ContentValues` object with our title and value, just as we used in `onCreate()` of `DatabaseHelper`. In `doInBackground()`, we get a

writable database from `DatabaseHelper` and perform the `insert()` call, so the database I/O does not tie up the main application thread.

However, in `doInBackground()`, we *also* call `doQuery()` again. This retrieves a fresh `Cursor` with the new roster of constants... including the one we just inserted. As with `LoadCursorTask`, we execute `doQuery()` in `doInBackground()` to keep the database I/O off the main application thread.

Then, in `onPostExecute()`, we can safely update the UI with the new `Cursor`. We do this by calling `changeCursor()` on our `CursorAdapter`, retrieved from the fragment via `getListAdapter()`. `changeCursor()` will swap out our old `Cursor` in our `SimpleCursorAdapter` with the new one, automatically updating the `ListView` along the way.

### Setting Transaction Bounds

By default, each SQL statement executes in its own transaction — this is fairly typical behavior for a SQL database, and SQLite is no exception.

There are two reasons why you might want to have your own transaction bounds, larger than a single statement:

1. The classic “we need the statements to succeed or fail as a whole” rationale, for maintaining data integrity
2. Performance, as each transaction involves disk I/O and, as has been noted, disk I/O can be rather slow

The basic recipe for your own transactions is:

```
try {
    db.beginTransaction();

    // several SQL statements in here

    db.setTransactionSuccessful();
}
finally {
    db.endTransaction();
}
```

`beginTransaction()` marks the fact that you want a transaction.  
`setTransactionSuccessful()` indicates that you want the transaction to commit.  
However, the actual `COMMIT` or `ROLLBACK` does not occur until `endTransaction()`. In

the normal case, `setTransactionSuccessful()` does get called, and `endTransaction()` performs a `COMMIT`. If, however, one of your SQL statements fails (e.g., violates a foreign key constraint), the `setTransactionSuccessful()` call is skipped, so `endTransaction()` will do a `ROLLBACK`.

## Hey, What About Hibernate?

Those of you with significant Java backgrounds outside of Android are probably pounding your head against your desk right about now. Outside of a few conveniences like `SQLiteOpenHelper` and `CursorAdapter`, Android's approach to database I/O feels a bit like classic JDBC. Java developers, having experienced the pain of raw JDBC, created various wrappers around it, the most prominent of which is an ORM (object-relational mapper) called Hibernate.

Alas, Hibernate is designed for servers, not mobile devices. It is a little bit heavyweight, and it is designed for use with JDBC, not Android's SQLite classes.

Android did not include any sort of ORM in the beginning for two main reasons:

1. To keep the firmware size as small as possible, as smaller firmware can lead to less-expensive devices
2. To eliminate the ORM overhead (e.g., reflection), which would have been too much for early Android versions on early Android devices

The Android ecosystem has come up with alternatives, the most popular of which being [ORMLite](#), which supports both classic JDBC and Android's SQLite classes. So, if you are used to using an ORM, you may want to investigate these sorts of solutions — they just are not built into Android itself.

## Visit the Trails!

If you are interested in exposing your database contents to a third-party application, you may wish to read up on [ContentProvider](#).

The trails also have chapters on [encrypted databases using SQLCipher](#) and [shipping pre-packaged databases with your app](#).

# Tutorial #14 - Saving Notes

---

It would be nice if the user could add some personal notes to the chapter that she is reading, whether that serves as commentary, points to be researched, complaints about the author's hair (or lack thereof), or whatever.

So, in this chapter, we will add a new fragment and new activity to allow the user to add notes per chapter, via a large `EditText` widget. Those notes will be stored in a SQLite database.

This is a continuation of the work we did in [the previous tutorial](#).

You can find [the results of the previous tutorial](#) and [the results of this tutorial](#) in [the book's GitHub repository](#).

Note that if you are importing the previous code to begin work here, you will also need the [copy of ActionBarSherlock in this book's GitHub repository](#), and to make sure that your imported `EmPubLite` project references the `ActionBarSherlock` project as a library.

## Step #1: Adding a DatabaseHelper

The first step for working with SQLite is to add an implementation of `SQLiteOpenHelper`, which we will do here, named `DatabaseHelper`.

If you wish to make this change using Eclipse's wizards and tools, follow the instructions in the "Eclipse" section below. Otherwise, follow the instructions in the "Outside of Eclipse" section (appears after the "Eclipse" section).

### Eclipse

Open `res/values/strings.xml` and add a new string resource, named `on_upgrade_error`, with a value of `This should not be called`.

Then, right click over the `com.commonware.empublite` package in the `src/` folder of your project, and choose `New > Class` from the context menu. Fill in `DatabaseHelper` in the “Name” field. Click the “Browse...” button next to the “Superclass” field and find `SQLiteOpenHelper` to set as the superclass. Then, click “Finish” on the new-class dialog to create the `DatabaseHelper` class.

Then, with `DatabaseHelper` open in the editor, paste in the following class definition:

```
package com.commonware.empublite;

import android.content.Context;
import android.database.Cursor;
import android.database.sqlite.SQLiteDatabase;
import android.database.sqlite.SQLiteOpenHelper;
import android.os.AsyncTask;

public class DatabaseHelper extends SQLiteOpenHelper {
    private static final String DATABASE_NAME="empublite.db";
    private static final int SCHEMA_VERSION=1;
    private static DatabaseHelper singleton=null;
    private Context ctxt=null;

    synchronized static DatabaseHelper getInstance(Context ctxt) {
        if (singleton == null) {
            singleton=new DatabaseHelper(ctxt.getApplicationContext());
        }

        return(singleton);
    }

    private DatabaseHelper(Context ctxt) {
        super(ctxt, DATABASE_NAME, null, SCHEMA_VERSION);
        this.ctxt=ctxt;
    }

    @Override
    public void onCreate(SQLiteDatabase db) {
        try {
            db.beginTransaction();
            db.execSQL("CREATE TABLE notes (position INTEGER PRIMARY KEY, prose
TEXT);");
            db.setTransactionSuccessful();
        }
        finally {
```

```
        db.endTransaction();
    }
}

@Override
public void onUpgrade(SQLiteDatabase db, int oldVersion,
    int newVersion) {
    throw new RuntimeException(
        ctxt.getString(R.string.on_upgrade_error));
}
}
```

### Outside of Eclipse

Create a `src/com/commonsware/empublite/DatabaseHelper.java` source file, with the content shown above. Also, add a new string resource, named `on_upgrade_error`, with a value of `This should not be called`.

## Step #2: Examining DatabaseHelper

Our initial version of `DatabaseHelper` has a few things:

- It has the constructor, supplying to the superclass the name of the database file (`DATABASE_NAME`) and the revision number of our schema (`SCHEMA_VERSION`). It also holds onto the supplied `Context` for use later in this chapter. Note that the constructor is private, as we are using the singleton pattern, so only `DatabaseHelper` should be able to create `DatabaseHelper` instances.
- It has the `onCreate()` method, invoked the first time we run the app on a device or emulator, to let us populate the database. Here, we use `execSQL()` to define a notes with a position column (indicating our chapter) and a prose column (what the user types in as the note). We wrap this in our own transaction for illustration purposes, though in this case, since there is only one SQL statement, it is not strictly necessary.
- It has the `onUpgrade()` method, needed because `SQLiteOpenHelper` is abstract, so our app will not compile without an implementation. Until we revise our schema, though, this method should never be called, so we raise a `RuntimeException` in the off chance that it is called unexpectedly.
- It has a static `DatabaseHelper` singleton instance and a `getInstance()` method to lazy-initialize it.

As noted in [the chapter on databases](#), it is important to ensure that all threads are accessing the same `SQLiteDatabase` object, for thread safety. That usually means you



hold onto a single `SQLiteOpenHelper` object. And, in our case, we might want to get at this database from more than one activity. Hence, we go with the singleton approach, so everyone works with the same `DatabaseHelper` instance.

### Step #3: Creating a NoteFragment

Having a database is nice and all, but we need to work on the UI to allow users to enter notes. To do that, we will start with a `NoteFragment`.

If you wish to make this change using Eclipse's wizards and tools, follow the instructions in the "Eclipse" section below. Otherwise, follow the instructions in the "Outside of Eclipse" section (appears after the "Eclipse" section).

#### Eclipse

Right click over the `res/layout/` directory in your project, and choose `New > File` from the context menu. Give the file a name of `editor.xml`. Then, in the Graphical Layout sub-tab of the Eclipse layout editor, click on the "Text Fields" section of the tool palette, and drag a "Multiline Text" widget into the layout. Give it an ID of `@+id/editor`. Change the "Layout height" and "Layout width" to be `match_parent`. Change the Gravity to be `top|left`. Finally, change the Hint to be a new string resource (named `hint`) with a value of `Enter notes here`.

Then, right click over the `com.commonware.empublite` package in the `src/` folder of your project, and choose `New > Class` from the context menu. Fill in `NoteFragment` in the "Name" field. Click the "Browse..." button next to the "Superclass" field and find `SherlockFragment` to set as the superclass. Then, click "Finish" on the new-class dialog to create the `NoteFragment` class.

Then, with `NoteFragment` open in the editor, paste in the following class definition:

```
package com.commonware.empublite;

import android.os.Bundle;
import android.view.LayoutInflater;
import android.view.View;
import android.view.ViewGroup;
import android.widget.EditText;
import com.actionbarsherlock.app.SherlockFragment;
import com.actionbarsherlock.view.Menu;
import com.actionbarsherlock.view.MenuInflater;
import com.actionbarsherlock.view.MenuItem;
```

## TUTORIAL #14 - SAVING NOTES

---

```
public class NoteFragment extends SherlockFragment {
    private static final String KEY_POSITION="position";
    private EditText editor=null;

    static NoteFragment newInstance(int position) {
        NoteFragment frag=new NoteFragment();
        Bundle args=new Bundle();

        args.putInt(KEY_POSITION, position);
        frag.setArguments(args);

        return(frag);
    }

    @Override
    public View onCreateView(LayoutInflater inflater,
                             ViewGroup container,
                             Bundle savedInstanceState) {
        View result=inflater.inflate(R.layout.editor, container, false);
        int position=getArguments().getInt(KEY_POSITION, -1);

        editor=(EditText)result.findViewById(R.id.editor);

        return(result);
    }
}
```

### Outside of Eclipse

Create a src/com/commonsware/empublite/NoteFragment.java source file, with the content shown in the code listing in the “Eclipse” section above.

Then, create a res/layout/editor.xml file with the following XML:

```
<EditText xmlns:android="http://schemas.android.com/apk/res/android"
    android:id="@+id/editor"
    android:layout_width="match_parent"
    android:layout_height="match_parent"
    android:gravity="left|top"
    android:hint="@string/hint"/>
```

You will also need to add a new <string> element in your res/values/strings.xml file, with a name of hint and a value like Enter notes here.

### Step #4: Examining NoteFragment

Our NoteFragment is fairly straightforward and is reminiscent of the SimpleContentFragment we created in [Tutorial #1](#).

NoteFragment has a newInstance() static factory method. This method creates an instance of NoteFragment, takes a passed-in int (identifying the chapter for which we are creating a note), puts it in a Bundle identified as KEY\_POSITION, hands the Bundle to the fragment as its arguments, and returns the newly-created NoteFragment.

In onCreateView(), we inflate the R.layout.editor resource that we defined and get our hands on our EditText widget for later use.

### Step #5: Creating the NoteActivity

Having a fragment without displaying it is fairly pointless, so we need something to load a NoteFragment. Particularly for phones, the simplest answer is to create a NoteActivity for that, paralleling the relationship between SimpleContentFragment and SimpleContentActivity.

If you wish to make this change using Eclipse's wizards and tools, follow the instructions in the "Eclipse" section below. Otherwise, follow the instructions in the "Outside of Eclipse" section (appears after the "Eclipse" section).

#### Eclipse

Right click over the com.commonware.empublite package in the src/ folder of your project, and choose New > Class from the context menu. Fill in NoteActivity in the "Name" field. Click the "Browse..." button next to the "Superclass" field and find SherlockFragmentActivity to set as the superclass. Then, click "Finish" on the new-class dialog to create the NoteActivity class.

Then, with NoteActivity open in the editor, paste in the following class definition:

```
package com.commonware.empublite;

import android.os.Bundle;
import android.support.v4.app.Fragment;
import com.actionbarsherlock.app.SherlockFragmentActivity;

public class NoteActivity extends SherlockFragmentActivity {
    public static final String EXTRA_POSITION="position";

    @Override
    public void onCreate(Bundle savedInstanceState) {
        super.onCreate(savedInstanceState);

        if
```

## TUTORIAL #14 - SAVING NOTES

---

```
(getSupportFragmentManager().findFragmentById(android.R.id.content)==null) {
    int position=getIntent().getIntExtra(EXTRA_POSITION, -1);

    if (position>=0) {
        Fragment f=NoteFragment.newInstance(position);

        getSupportFragmentManager().beginTransaction()
            .add(android.R.id.content, f).commit();
    }
}
}
```

As you can see, this is a fairly trivial activity. In `onCreate()`, if we are being created anew, we execute a `FragmentManager` to add a `NoteFragment` to our activity, pouring it into the full screen (`android.R.id.content`). However, we expect that we will be passed an `Intent` extra with the position (`EXTRA_POSITION`), which we pass along to the `NoteFragment` factory method.

You will also need to add a new activity node to the list of nodes in the `Application` sub-tab of `AndroidManifest.xml`, pointing to `NoteActivity`, following the same approach that we used for other activities in this application.

### Outside of Eclipse

Create a `src/com/commonsware/empublite/NoteActivity.java` source file, with the content shown in the code listing in the “Eclipse” section above. Also add the corresponding `<activity>` element in the manifest:

```
<activity android:name="NoteActivity"/>
```

## Step #6: Loading and Saving Notes

So, we have a database, a fragment, and an activity. If we started up the activity, the user could type in some notes... which would not be stored, nor loaded, from the database. Hence, we have a bit more work to do before we let the user into this UI.

In addition, since database I/O can be slow, we really need to ensure that we are loading and saving our notes asynchronously. In particular, we need to allow the `NoteFragment` to load a note, yet get that note’s prose back via some sort of asynchronous mechanism, rather than having some sort of blocking call.

## TUTORIAL #14 - SAVING NOTES

---

In this tutorial, we will isolate much of the database-handling logic on the DatabaseHelper, beyond what is required by the SQLiteOpenHelper abstract class.

To that end, let us first set up an interface, NoteListener, defined as an inner interface of DatabaseHelper:

```
interface NoteListener {
    void setNote(String note);
}
```

For the asynchronous work, we can use our good friend AsyncTask. First, let us load a note from the database, by defining a GetNoteTask as an inner class of our DatabaseHelper:

```
private class GetNoteTask extends AsyncTask<Integer, Void, String> {
    private NoteListener listener=null;

    GetNoteTask(NoteListener listener) {
        this.listener=listener;
    }

    @Override
    protected String doInBackground(Integer... params) {
        String[] args= { params[0].toString() };

        Cursor c=
            getReadableDatabase().rawQuery("SELECT prose FROM notes WHERE
position=?",
                                           args);

        c.moveToFirst();

        if (c.isAfterLast()) {
            return(null);
        }

        String result=c.getString(0);

        c.close();

        return(result);
    }

    @Override
    public void onPostExecute(String prose) {
        listener.setNote(prose);
    }
}
```

## TUTORIAL #14 - SAVING NOTES

---

This is a regular inner class, not a static inner class, which should cause you to pause for a moment — a regular inner class can be dangerous with configuration changes. However, in this case, this is an inner class of our DatabaseHelper, which is a singleton and will be unaffected directly by any configuration changes.

GetNoteTask will need two pieces of data:

- the position (i.e., chapter) whose notes we need to load, which will be supplied as an Integer to `doInBackground()` by way of `execute()`, and
- a `NoteListener` that we can supply the loaded prose to, which `GetNoteTask` takes in its constructor

Our `doInBackground()` gets a readable database from `DatabaseHelper` and proceeds to use `rawQuery()` to retrieve the prose, given the position, returning `null` if there is no such note (e.g., the user is trying to edit the note for a chapter for the first time). The prose is returned by `doInBackground()` and supplied to `onPostExecute()`, which turns around and calls `setNote()` on our `NoteListener` to pass it along to the UI on the main application thread.

Similarly, we will need a `SaveNoteTask` as an inner class of `DatabaseHelper`:

```
private class SaveNoteTask extends AsyncTask<Void, Void, Void> {
    private int position;
    private String note=null;

    SaveNoteTask(int position, String note) {
        this.position=position;
        this.note=note;
    }

    @Override
    protected Void doInBackground(Void... params) {
        String[] args= { String.valueOf(position), note };

        getWritableDatabase().execSQL("INSERT OR REPLACE INTO notes (position,
prose) VALUES (?, ?)",
                                   args);

        return(null);
    }
}
```

In this case, we need both the position and the note to be saved, which `SaveNoteTask` collects in its constructor. In `doInBackground()`, we use SQLite's `INSERT OR REPLACE` SQL statement to either `INSERT` a new note or `UPDATE` an existing note, based on the supplied position. We could avoid this by tracking

## TUTORIAL #14 - SAVING NOTES

---

whether or not we had a note from our `GetNoteTask` and using the `insert()` and `update()` methods on `SQLiteDatabase`, but the `INSERT OR REPLACE` approach is a bit more concise in this case.

To invoke those tasks, we can create methods on `DatabaseHelper`:

```
void getNoteAsync(int position, NoteListener listener) {
    ModelFragment.executeAsyncTask(new GetNoteTask(listener), position);
}

void saveNoteAsync(int position, String note) {
    ModelFragment.executeAsyncTask(new SaveNoteTask(position, note));
}
```

These methods use the static `executeAsyncTask()` method on `ModelFragment` that uses `execute()` or `executeOnExecutor()` as appropriate.

Over in `NoteFragment`, we need to use our new `getNoteAsync()` method to load the note for use in our `EditText`. To that end, add the following statement to the `onCreateView()` in `NoteFragment`, just before the return:

```
DatabaseHelper.getInstance(getActivity()).getNoteAsync(position,
                                                       this);
```

Here, we retrieve our singleton `DatabaseHelper` and tell it to load our note, passing the results to ourselves as the `NoteListener`.

For that to work, though, we will need to add implements `DatabaseHelper.NoteListener` to the class declaration:

```
public class NoteFragment extends SherlockFragment implements
    DatabaseHelper.NoteListener {
```

That, in turn, requires us to implement `setNote()`:

```
@Override
public void setNote(String note) {
    editor.setText(note);
}
```

The net result is that we load our note, asynchronously, into our `EditText`.

However, we also need to save our notes. The simplest UI approach for this is to automatically save the notes when the fragment is no longer in the foreground, by

## TUTORIAL #14 - SAVING NOTES

---

implementing `onPause()`. So, add the following `onPause()` implementation to `NoteFragment`:

```
@Override
public void onPause() {
    int position=getArguments().getInt(KEY_POSITION, -1);

    DatabaseHelper.getInstance(getActivity())
        .saveNoteAsync(position, editor.getText().toString());

    super.onPause();
}
```

All we do is retrieve our position and ask our `DatabaseHelper` to save the note asynchronously, supplying the note prose itself from the `EditText` widget.

### Step #7: Add Notes to the Action Bar

Now, we can let our user actually start working with the notes, by giving them a way to get to the `NoteActivity`.

Specifically, we can add a notes entry to our `res/menu/options.xml` resource, to have a new toolbar button appear on our main activity's action bar:

```
<menu xmlns:android="http://schemas.android.com/apk/res/android">

    <item
        android:id="@+id/notes"
        android:icon="@android:drawable/ic_menu_edit"
        android:showAsAction="ifRoom|withText"
        android:title="@string/notes">
    </item>
    <item
        android:id="@+id/settings"
        android:icon="@android:drawable/ic_menu_preferences"
        android:showAsAction="never"
        android:title="@string/settings">
    </item>
    <item
        android:id="@+id/help"
        android:icon="@android:drawable/ic_menu_help"
        android:showAsAction="never"
        android:title="@string/help">
    </item>
    <item
        android:id="@+id/about"
        android:icon="@android:drawable/ic_menu_info_details"
        android:showAsAction="never"
        android:title="@string/about">
    </item>
</menu>
```



## TUTORIAL #14 - SAVING NOTES

---

```
</item>
</menu>
```

Eclipse users can add this via the structured editor for `res/menu/options.xml`, following the instructions used for other action bar items.

Note that this menu definition requires a new string resource, named `notes`, with a value like `Notes`.

Then, in `EmPubLiteActivity`, add the following case to the switch statement in `onOptionsItemSelected()`:

```
case R.id.notes:
    Intent i=new Intent(this, NoteActivity.class);
    i.putExtra(NoteActivity.EXTRA_POSITION, pager.getCurrentItem());
    startActivity(i);
    return(true);
```

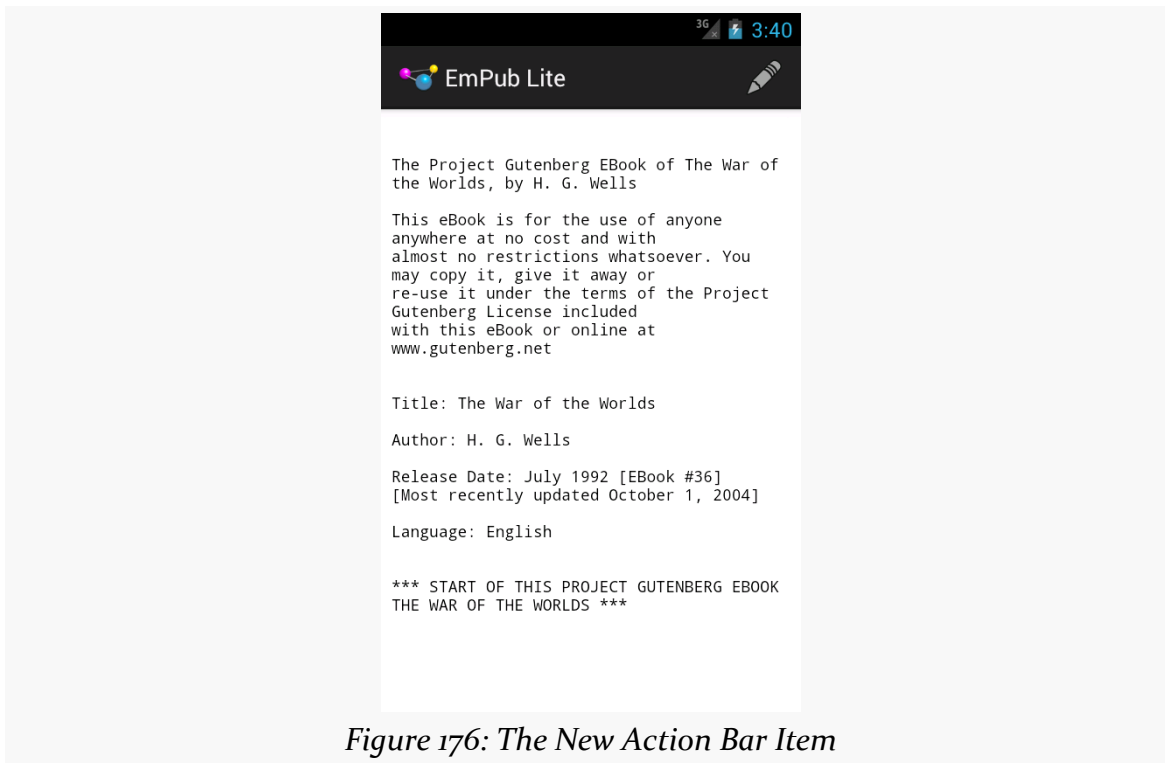
Note that depending on where you place this, you will need to remove one existing declaration of `Intent i` from one of the case blocks, whichever comes second.

Here, we get the currently-viewed position from the `ViewPager` and pass that as the `EXTRA_POSITION` extra to `NoteActivity`.

If you build and run the app on a device or emulator, you will see the new toolbar button in the action bar:

## TUTORIAL #14 - SAVING NOTES

---



*Figure 176: The New Action Bar Item*

Tapping that will bring up the notes for whatever chapter you are on. Entering in some notes and pressing BACK to exit the activity will save those notes, which you will see again if you tap the action bar toolbar button again. If you change the notes, pressing BACK will save the changed notes in the database, to be viewed again later when you go back into the notes for that chapter.

### Step #8: Support Deleting Notes

So, we can now add and edit notes. However, the only way we can “delete” a note is to blank out the EditText. While that works, it would be nice to offer a cleaner delete option.

First, we need to add some more logic to DatabaseHelper to delete notes. As with getting and saving notes, this will involve an AsyncTask and a method to execute an instance of that task.

With that in mind, add the following inner class to DatabaseHelper:

```
private class DeleteNoteTask extends AsyncTask<Integer, Void, Void> {  
    @Override
```

## TUTORIAL #14 - SAVING NOTES

---

```
protected Void doInBackground(Integer... params) {
    String[] args= { params[0].toString() };

    getWritableDatabase().execSQL("DELETE FROM notes WHERE position=?",
                                  args);

    return(null);
}
}
```

Here, given the position (supplied as an Integer to `doInBackground()`), we execute a DELETE statement to get rid of it. This could also have been implemented using the `delete()` method on `SQLiteDatabase`.

Then, add a `deleteNoteAsync()` method to `DatabaseHelper`, to invoke our `DeleteNoteTask`:

```
void deleteNoteAsync(int position) {
    ModelFragment.executeAsyncTask(new DeleteNoteTask(), position);
}
```

Our full `DatabaseHelper` at this point should look like:

```
package com.commonware.empublite;

import android.content.Context;
import android.database.Cursor;
import android.database.sqlite.SQLiteDatabase;
import android.database.sqlite.SQLiteOpenHelper;
import android.os.AsyncTask;

public class DatabaseHelper extends SQLiteOpenHelper {
    private static final String DATABASE_NAME="empublite.db";
    private static final int SCHEMA_VERSION=1;
    private static DatabaseHelper singleton=null;
    private Context ctxt=null;

    synchronized static DatabaseHelper getInstance(Context ctxt) {
        if (singleton == null) {
            singleton=new DatabaseHelper(ctxt.getApplicationContext());
        }

        return(singleton);
    }

    private DatabaseHelper(Context ctxt) {
        super(ctxt, DATABASE_NAME, null, SCHEMA_VERSION);
        this.ctxt=ctxt;
    }

    @Override
```

## TUTORIAL #14 - SAVING NOTES

---

```
public void onCreate(SQLiteDatabase db) {
    try {
        db.beginTransaction();
        db.execSQL("CREATE TABLE notes (position INTEGER PRIMARY KEY, prose
TEXT);");
        db.setTransactionSuccessful();
    }
    finally {
        db.endTransaction();
    }
}

@Override
public void onUpgrade(SQLiteDatabase db, int oldVersion,
    int newVersion) {
    throw new RuntimeException(
        ctxt.getString(R.string.on_upgrade_error));
}

void getNoteAsync(int position, NoteListener listener) {
    ModelFragment.executeAsyncTask(new GetNoteTask(listener), position);
}

void saveNoteAsync(int position, String note) {
    ModelFragment.executeAsyncTask(new SaveNoteTask(position, note));
}

void deleteNoteAsync(int position) {
    ModelFragment.executeAsyncTask(new DeleteNoteTask(), position);
}

interface NoteListener {
    void setNote(String note);
}

private class GetNoteTask extends AsyncTask<Integer, Void, String> {
    private NoteListener listener=null;

    GetNoteTask(NoteListener listener) {
        this.listener=listener;
    }

    @Override
    protected String doInBackground(Integer... params) {
        String[] args= { params[0].toString() };

        Cursor c=
            getReadableDatabase().rawQuery("SELECT prose FROM notes WHERE
position=?",
                args);

        c.moveToFirst();

        if (c.isAfterLast()) {
```

## TUTORIAL #14 - SAVING NOTES

---

```
        return(null);
    }

    String result=c.getString(0);

    c.close();

    return(result);
}

@Override
public void onPostExecute(String prose) {
    listener.setNote(prose);
}
}

private class SaveNoteTask extends AsyncTask<Void, Void, Void> {
    private int position;
    private String note=null;

    SaveNoteTask(int position, String note) {
        this.position=position;
        this.note=note;
    }

    @Override
    protected Void doInBackground(Void... params) {
        String[] args= { String.valueOf(position), note };

        getWritableDatabase().execSQL("INSERT OR REPLACE INTO notes (position,
prose) VALUES (?, ?)",
                                     args);

        return(null);
    }
}

private class DeleteNoteTask extends AsyncTask<Integer, Void, Void> {
    @Override
    protected Void doInBackground(Integer... params) {
        String[] args= { params[0].toString() };

        getWritableDatabase().execSQL("DELETE FROM notes WHERE position=?",
                                     args);

        return(null);
    }
}
}
```

Next, let's create a new resource, `res/menu/notes.xml`, to configure the action bar for the activity hosting our `NoteFragment`:

## TUTORIAL #14 - SAVING NOTES

---

```
<menu xmlns:android="http://schemas.android.com/apk/res/android">
    <item
        android:id="@+id/delete"
        android:icon="@android:drawable/ic_menu_delete"
        android:showAsAction="ifRoom|withText"
        android:title="@string/delete">
    </item>
</menu>
```

This simply defines a single action bar item, with an ID of delete.

Eclipse users can right-click over the `res/menu/` directory and choose `New > File` from the context menu, filling in `notes.xml` as the file name. Then, use the structured resource editor to add a new menu resource, with an ID of `delete`, an icon of `@android:drawable/ic_menu_delete`, and a title that consists of a new delete string resource (with a value of `Delete`). Also, mark this new item as `ifRoom|withText` for the “Show as action” item.

To let Android know that our `NoteFragment` wishes to participate in the action bar, we need to call `setHasOptionsMenu(true)` at some point. The easiest place to put that would be in our `onCreateView()` implementation in `NoteFragment`:

```
@Override
public View onCreateView(LayoutInflater inflater,
                        ViewGroup container,
                        Bundle savedInstanceState) {
    View result=inflater.inflate(R.layout.editor, container, false);
    int position=getArguments().getInt(KEY_POSITION, -1);

    editor=(EditText)result.findViewById(R.id.editor);
    DatabaseHelper.getInstance(getActivity()).getNoteAsync(position,
                                                            this);

    setHasOptionsMenu(true);

    return(result);
}
```

That will trigger a call to `onCreateOptionsMenu()`, which we will need to add to `NoteFragment`:

```
@Override
public void onCreateOptionsMenu(Menu menu, MenuInflater inflater) {
    inflater.inflate(R.menu.notes, menu);

    super.onCreateOptionsMenu(menu, inflater);
}
```

## TUTORIAL #14 - SAVING NOTES

---

This just inflates our new resource for use in the options menu.

If the user taps on that toolbar button, `onOptionsItemSelected()` will be called, so we will need to add that as well to `NoteFragment`:

```
@Override
public boolean onOptionsItemSelected(MenuItem item) {
    if (item.getItemId() == R.id.delete) {
        int position=getArguments().getInt(KEY_POSITION, -1);

        isDeleted=true;
        DatabaseHelper.getInstance(getActivity())
            .deleteNoteAsync(position);

        ((NoteActivity)getActivity()).closeNotes();

        return(true);
    }

    return(super.onOptionsItemSelected(item));
}
```

Here, if the user tapped the delete item, we update an `isDeleted` data member to track that our note is now deleted, plus use the new `deleteNoteAsync()` method on `DatabaseHelper` to actually get rid of the note. We also call a `closeNotes()` method on our hosting activity to indicate that we are no longer needed on the screen (since the note is deleted).

For this to build, we will need to add `isDeleted` to `NoteFragment` as a data member:

```
private boolean isDeleted=false;
```

The reason for tracking `isDeleted` is for `onPause()`, so when our fragment leaves the foreground, we do not inadvertently save it again. So, update `onPause()` to only do its work if `isDeleted` is false:

```
@Override
public void onPause() {
    if (!isDeleted) {
        int position=getArguments().getInt(KEY_POSITION, -1);

        DatabaseHelper.getInstance(getActivity())
            .saveNoteAsync(position, editor.getText().toString());
    }

    super.onPause();
}
```

## TUTORIAL #14 - SAVING NOTES

---

The complete NoteFragment, at this point, should look like:

```
package com.commonware.empublite;

import android.os.Bundle;
import android.view.LayoutInflater;
import android.view.View;
import android.view.ViewGroup;
import android.widget.EditText;
import com.actionbarsherlock.app.SherlockFragment;
import com.actionbarsherlock.view.Menu;
import com.actionbarsherlock.view.MenuInflater;
import com.actionbarsherlock.view.MenuItem;

public class NoteFragment extends SherlockFragment implements
    DatabaseHelper.NoteListener {
    private static final String KEY_POSITION="position";
    private EditText editor=null;
    private boolean isDeleted=false;

    static NoteFragment newInstance(int position) {
        NoteFragment frag=new NoteFragment();
        Bundle args=new Bundle();

        args.putInt(KEY_POSITION, position);
        frag.setArguments(args);

        return(frag);
    }

    @Override
    public View onCreateView(LayoutInflater inflater,
        ViewGroup container,
        Bundle savedInstanceState) {
        View result=inflater.inflate(R.layout.editor, container, false);
        int position=getArguments().getInt(KEY_POSITION, -1);

        editor=(EditText)result.findViewById(R.id.editor);
        DatabaseHelper.getInstance(getActivity()).getNoteAsync(position,
            this);

        setHasOptionsMenu(true);

        return(result);
    }

    @Override
    public void onPause() {
        if (!isDeleted) {
            int position=getArguments().getInt(KEY_POSITION, -1);

            DatabaseHelper.getInstance(getActivity())
                .saveNoteAsync(position, editor.getText().toString());
        }
    }
}
```



## TUTORIAL #14 - SAVING NOTES

---

```
    super.onPause();
}

@Override
public void onCreateOptionsMenu(Menu menu, MenuInflater inflater) {
    inflater.inflate(R.menu.notes, menu);

    super.onCreateOptionsMenu(menu, inflater);
}

@Override
public boolean onOptionsItemSelected(MenuItem item) {
    if (item.getItemId() == R.id.delete) {
        int position=getArguments().getInt(KEY_POSITION, -1);

        isDeleted=true;
        DatabaseHelper.getInstance(getActivity())
            .deleteNoteAsync(position);

        ((NoteActivity)getActivity()).closeNotes();

        return(true);
    }

    return(super.onOptionsItemSelected(item));
}

@Override
public void setNote(String note) {
    editor.setText(note);
}
}
```

However, we also need to implement `closeNotes()` on `NoteActivity`, as we are trying to call that from `onOptionsItemSelected()`:

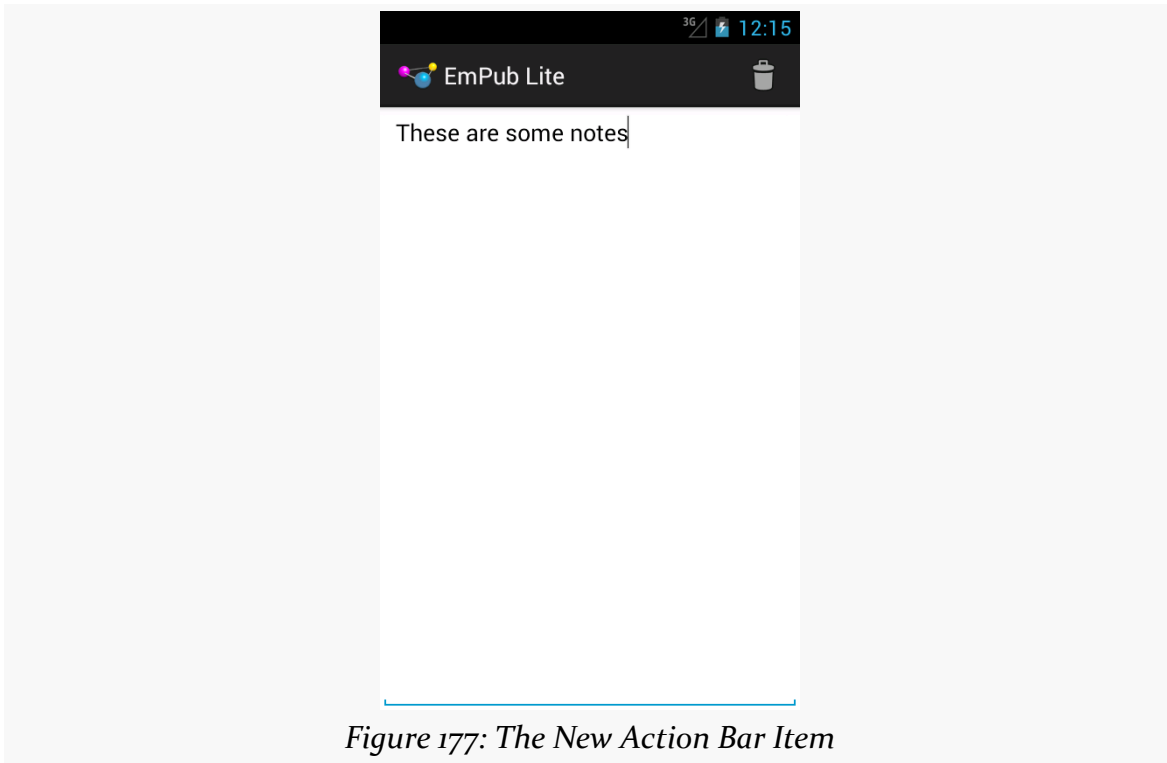
```
void closeNotes() {
    finish();
}
```

Here, we just call `finish()` to get rid of the activity and return us to `EmPubLiteActivity`.

If you run this in a device or emulator, and you go into the notes, you will see our delete toolbar button:

## TUTORIAL #14 - SAVING NOTES

---



*Figure 177: The New Action Bar Item*

Tapping that toolbar button will delete the note (if there is one) and close the activity, returning you to the book.

### **In Our Next Episode...**

... we will allow the user to [share a chapter's notes](#) with somebody else.



# Internet Access

---

The expectation is that most, if not all, Android devices will have built-in Internet access. That could be WiFi, cellular data services (EDGE, 3G, etc.), or possibly something else entirely. Regardless, most people — or at least those with a data plan or WiFi access — will be able to get to the Internet from their Android phone.

Not surprisingly, the Android platform gives developers a wide range of ways to make use of this Internet access. Some offer high-level access, such as the integrated WebKit browser component (WebView) we saw in an [earlier chapter](#). If you want, you can drop all the way down to using raw sockets. Or, in between, you can leverage APIs — both on-device and from 3rd-party JARs — that give you access to specific protocols: HTTP, XMPP, SMTP, and so on.

The emphasis of this book is on the higher-level forms of access: the [WebKit component](#) and Internet-access APIs, as busy coders should be trying to reuse existing components versus rolling one's own on-the-wire protocol wherever possible.

## DIY HTTP

In many cases, your only viable option for accessing some Web service or other HTTP-based resource is to do the request yourself. The preferred API for doing this nowadays in Android is to use the classic `java.net` classes for HTTP operation, centered around `URLConnection`. There is quite a bit of material on this already published, as these classes have been in Java for a long time. The focus here is in showing how this works in an Android context.

### Introducing the Sample

In this section, we will take a look at the [Internet/Weather](#) sample project. This project does several things:

- It requests our location from `LocationManager`, specifically using GPS
- It retrieves the weather for our location from the US National Weather Service (NWS) for the latitude and longitude we get from `LocationManager`
- It parses the XML received from the NWS, generates a Web page in response, and displays that Web page in a `WebView` widget

Later in this book, we will examine the `LocationManager` portion of this sample. For the moment, we will focus on the Internet access.

### Asking Permission

To do anything with the Internet (or a local network) from your app, you need to hold the `INTERNET` permission. This includes cases where you use things like `WebView` — if your *process* needs network access, you need the `INTERNET` permission.

Hence, the manifest for our sample project contains the requisite `<uses-permission>` declaration:

```
<uses-permission android:name="android.permission.INTERNET"/>
```

### A Task for Updating

We have an activity (`WeatherDemo`) which follows the standard load-the-dynamic-fragment pattern seen throughout this book, this time setting up `WeatherFragment`:

```
package com.commonware.android.weather;

import android.os.Bundle;
import com.actionbarsherlock.app.SherlockFragmentActivity;

public class WeatherDemo extends SherlockFragmentActivity {
    @Override
    public void onCreate(Bundle savedInstanceState) {
        super.onCreate(savedInstanceState);

        if
(getSupportFragmentManager().findFragmentById(android.R.id.content)==null) {
            getSupportFragmentManager().beginTransaction()
                .add(android.R.id.content,
```

## INTERNET ACCESS

---

```
        new WeatherFragment().commit();
    }
}
```

Eventually, when we get a GPS fix, the `onLocationChanged()` method of `WeatherFragment` will be called — we will get into the details of how this occurs later in this book when we cover `LocationManager`. Suffice it to say that it happens, and more importantly, it happens on the main application thread.

We do not want to do Internet access on the main application thread, as we have no idea if it will complete quickly.

So, we set up an `AsyncTask`, named `FetchForecastTask`, and execute an instance of it:

```
@Override
public void onLocationChanged(Location location) {
    FetchForecastTask task=new FetchForecastTask();

    task.execute(location);
}
```

The `Location` object supplied to `onLocationChanged()` will contain, among other things, our latitude (`getLatitude()`) and longitude (`getLongitude()`) in decimal degrees as Java double values.

The `doInBackground()` of `FetchForecastTask` is where we can do all the downloading and parsing of our Web service call:

```
class FetchForecastTask extends AsyncTask<Location, Void, String> {
    Exception e=null;

    @Override
    protected String doInBackground(Location... locs) {
        String page=null;

        try {
            Location loc=locs[0];
            String url=
                String.format(template, loc.getLatitude(),
                    loc.getLongitude());

            page=generatePage(buildForecasts(getForecastXML(url)));
        }
        catch (Exception e) {
            this.e=e;
        }
    }
}
```

```
        return(page);
    }

    @Override
    protected void onPostExecute(String page) {
        if (e == null) {
            getWebView().loadDataWithBaseURL(null, page, "text/html",
                "UTF-8", null);
        }
        else {
            Log.e(getClass().getSimpleName(), "Exception fetching data", e);
            Toast.makeText(getActivity(),
                String.format(getString(R.string.error),
                    e.toString()), Toast.LENGTH_LONG)
                .show();
        }
    }
}
```

We need to synthesize a URL to access that NWS REST endpoint for getting a forecast based upon latitude and longitude. A template of that URL is held in a string resource named `R.string.url` (too long to reprint here) and is stored in a data member named `template` up in `onCreate()`:

```
template=getActivity().getString(R.string.url);
```

We use the `String.format()` method to pour our latitude and longitude from the `Location` object into the template to get a fully-qualified URL (fortunately, floating-point numbers do not need to be URL-encoded).

We then execute a series of methods, defined on the fragment, to handle the actual Web service call:

- `getForecastXML()` makes the HTTP request and retrieves the XML from the NWS REST endpoint
- `buildForecasts()` parses that XML into a series of `Forecast` objects
- `generatePage()` takes the `Forecast` objects and crafts a Web page to display the forecast

However, these might fail with an `Exception` (e.g., no connectivity, malformed XML). If one does, we hold onto the `Exception` in a data member of `FetchForecastTask`, so we can use it in `onPostExecute()` on the main application thread.

## Doing the Internet Thing

The `getForecastXML()` method uses a fairly typical recipe for fetching data off the Internet from an HTTP URL using `URLConnection`:

```
private String getForecastXML(String path) throws IOException {
    BufferedReader reader=null;

    try {
        URL url=new URL(path);
        HttpURLConnection c=(HttpURLConnection)url.openConnection();

        c.setRequestMethod("GET");
        c.setReadTimeout(15000);
        c.connect();

        reader=
            new BufferedReader(new InputStreamReader(c.getInputStream()));

        StringBuilder buf=new StringBuilder();
        String line=null;

        while ((line=reader.readLine()) != null) {
            buf.append(line + "\n");
        }

        return(buf.toString());
    }
    finally {
        if (reader != null) {
            reader.close();
        }
    }
}
```

We give the connection the URL, the verb (GET), and a 15-second timeout, then execute the request and use a `StringBuilder` to get the response back as a `String`. If this fails for any reason, it will raise an `Exception`, which will be caught by `FetchForecastTask`.

## Dealing with the Result

The `buildForecasts()` method uses the DOM to parse the rather bizarre XML format returned by the NWS REST endpoint:

```
private ArrayList<Forecast> buildForecasts(String raw)
    throws Exception {
    ArrayList<Forecast> forecasts=new ArrayList<Forecast>();
    DocumentBuilder builder=
```



```
        DocumentBuilderFactory.newInstance().newDocumentBuilder();
        Document doc=builder.parse(new InputSource(new StringReader(raw)));
        NodeList times=doc.getElementsByTagName("start-valid-time");

        for (int i=0; i < times.getLength(); i++) {
            Element time=(Element)times.item(i);
            Forecast forecast=new Forecast();

            forecasts.add(forecast);
            forecast.setTime(time.getFirstChild().getNodeValue());
        }

        NodeList temps=doc.getElementsByTagName("value");

        for (int i=0; i < temps.getLength(); i++) {
            Element temp=(Element)temps.item(i);
            Forecast forecast=forecasts.get(i);

            forecast.setTemp(new Integer(temp.getFirstChild().getNodeValue()));
        }

        NodeList icons=doc.getElementsByTagName("icon-link");

        for (int i=0; i < icons.getLength(); i++) {
            Element icon=(Element)icons.item(i);
            Forecast forecast=forecasts.get(i);

            forecast.setIcon(icon.getFirstChild().getNodeValue());
        }

        return(forecasts);
    }
}
```

(using SAX might be faster in this case — the proof of this is left as an exercise to the reader)

That XML is converted into a series of Forecast objects, representing the triple of time, projected temperature, and a code identifying the projected weather. That code maps to a series of icons up on the NWS Web site.

The generatePage() method takes those Forecast objects and generates a trivial HTML page with a table containing the results.

Back in our FetchForecastTask, onPostExecute() loads that HTML into a WebView via loadDataWithBaseURL(). The WebView comes from our parent class, WebViewFragment, a port of the native WebViewFragment from Android that works on Android 2.x and ActionBarSherlock, as the native WebViewFragment only exists on API Level 11 and higher:

## INTERNET ACCESS

---

```
import android.os.Build;
import android.os.Bundle;
import android.view.LayoutInflater;
import android.view.View;
import android.view.ViewGroup;
import android.webkit.WebView;
import com.actionbarsherlock.app.SherlockFragment;

/**
 * A fragment that displays a WebView.
 * <p>
 * The WebView is automatically paused or resumed when the
 * Fragment is paused or resumed.
 */
public class WebViewFragment extends SherlockFragment {
    private WebView mWebView;
    private boolean mIsWebViewAvailable;

    public WebViewFragment() {
    }

    /**
     * Called to instantiate the view. Creates and returns the
     * WebView.
     */
    @Override
    public View onCreateView(LayoutInflater inflater,
                             ViewGroup container,
                             Bundle savedInstanceState) {
        if (mWebView != null) {
            mWebView.destroy();
        }

        mWebView=new WebView(getActivity());
        mIsWebViewAvailable=true;
        return mWebView;
    }

    /**
     * Called when the fragment is visible to the user and
     * actively running. Resumes the WebView.
     */
    @TargetApi(11)
    @Override
    public void onPause() {
        super.onPause();

        if (Build.VERSION.SDK_INT >= Build.VERSION_CODES.HONEYCOMB) {
            mWebView.onPause();
        }
    }

    /**
     * Called when the fragment is no longer resumed. Pauses

```

```
* the WebView.
*/
@TargetApi(11)
@Override
public void onResume() {
    if (Build.VERSION.SDK_INT >= Build.VERSION_CODES.HONEYCOMB) {
        mWebView.onResume();
    }

    super.onResume();
}

/**
 * Called when the WebView has been detached from the
 * fragment. The WebView is no longer available after this
 * time.
 */
@Override
public void onDestroyView() {
    mIsWebViewAvailable=false;
    super.onDestroyView();
}

/**
 * Called when the fragment is no longer in use. Destroys
 * the internal state of the WebView.
 */
@Override
public void onDestroy() {
    if (mWebView != null) {
        mWebView.destroy();
        mWebView=null;
    }
    super.onDestroy();
}

/**
 * Gets the WebView.
 */
public WebView getWebView() {
    return mIsWebViewAvailable ? mWebView : null;
}
}
```

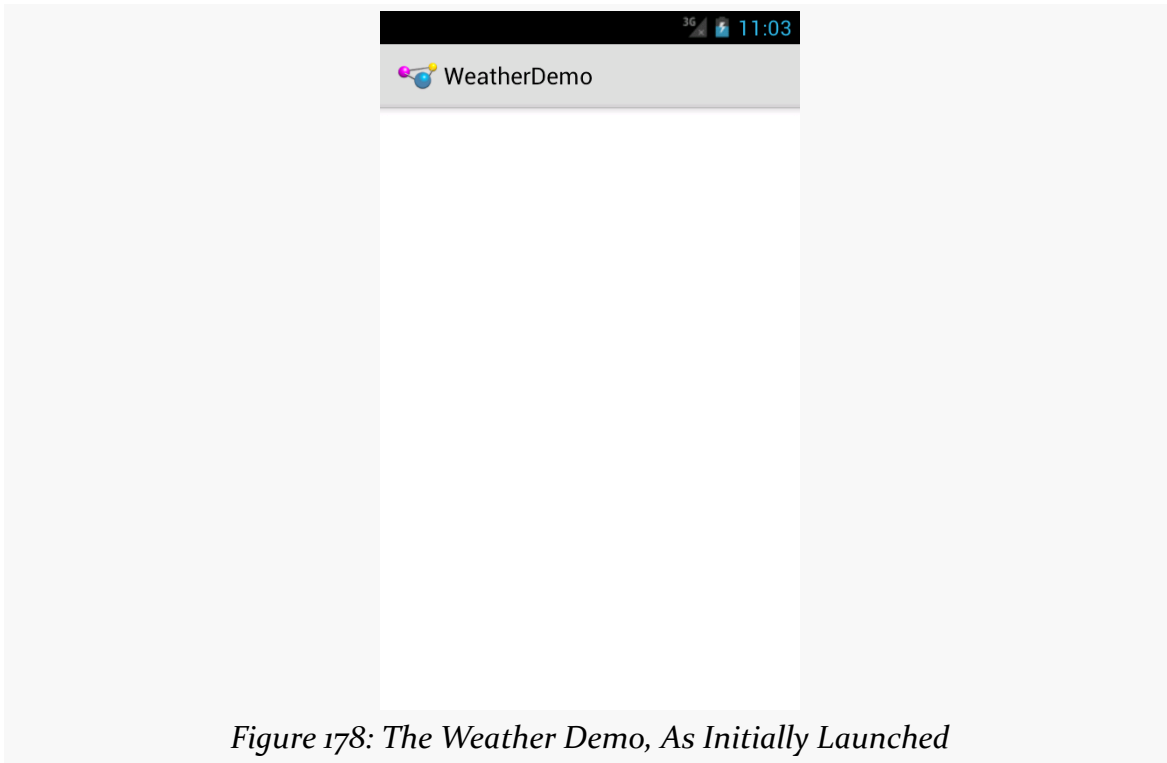
If we encountered an Exception, though, `onPostExecute()` logs the stack trace to LogCat, plus displays a Toast to let the user know of our difficulty.

### Running the Sample

When you run the sample, initially it will appear as though the forecast is heavy fog, or perhaps a blizzard:

## INTERNET ACCESS

---

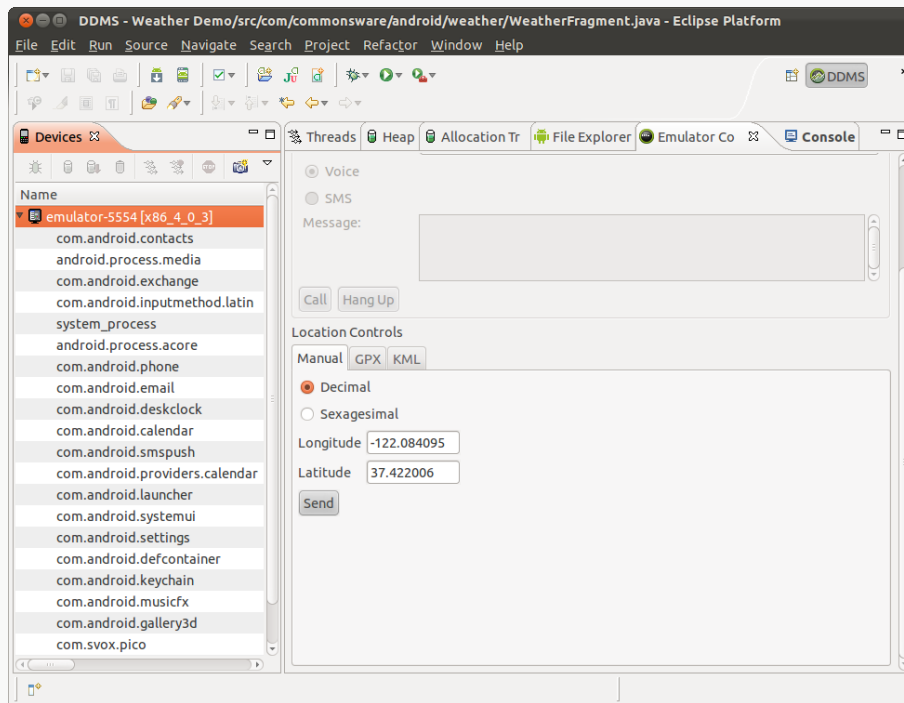


*Figure 178: The Weather Demo, As Initially Launched*

That is because Android is waiting on a GPS fix. If you are running on an actual piece of Android hardware with an enabled GPS receiver (and you live within the area covered by the US National Weather Service's REST API), you should get a forecast shortly.

If you are testing on an emulator, you can fake a GPS fix via DDMS. In Eclipse, go to the DDMS perspective, click on your emulator in the Devices tool, then click on the Emulator Control tool and scroll down to the Location Controls:

## INTERNET ACCESS



*Figure 179: The DDMS Perspective, with Location Controls*

Here, you can fill in a longitude and latitude (pay attention to the order!), then click “Send”. The fields are filled in by default with the location of the Google headquarters in Mountain View, CA, so simply clicking “Send” will bring up the weather forecast for the Googleplex:

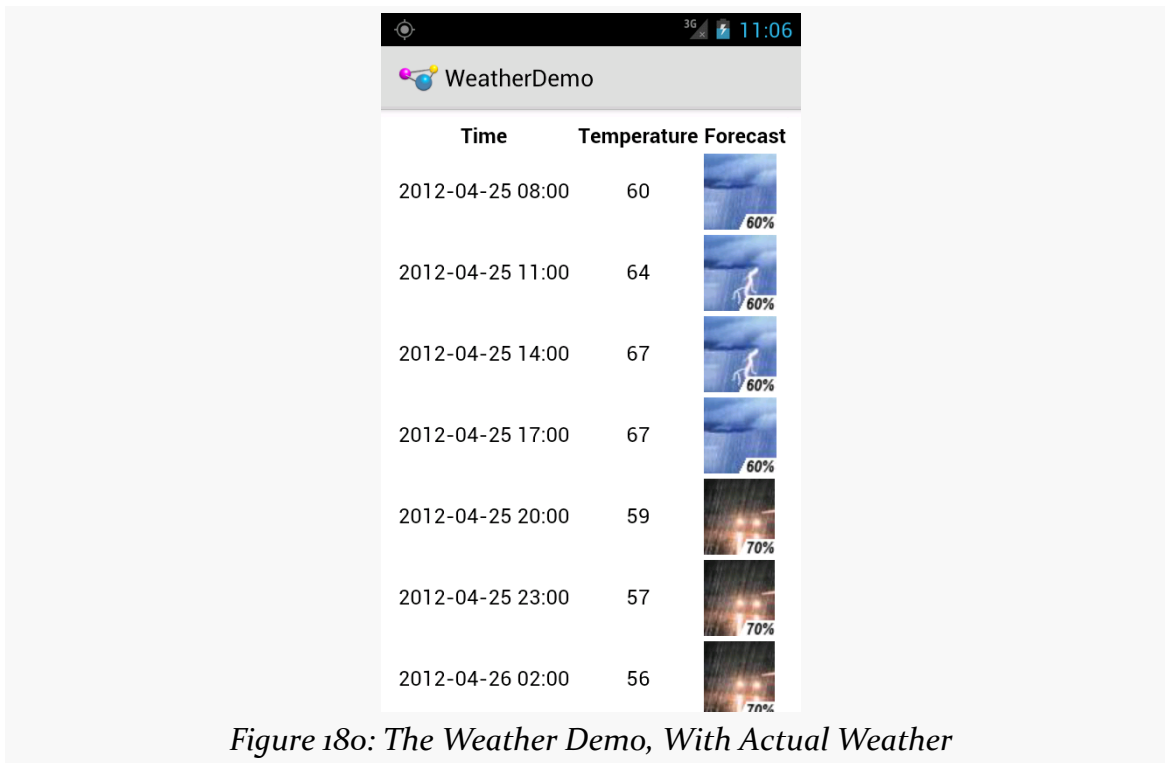


Figure 180: The Weather Demo, With Actual Weather

## What Android Brings to the Table

Google has augmented `URLConnection` to do more stuff to help developers. Notably:

- It automatically uses GZip compression on requests, adding the appropriate HTTP header and automatically decompressing any compressed responses (added in Android 2.3)
- It uses [Server Name Indication](#) to help work with several HTTPS hosts sharing a single IP address
- API Level 13 (Android 4.0) added an `HttpResponseCache` implementation of the `java.net.ResponseCache` base class, that can be installed to offer transparent caching of your HTTP requests.

## Testing with StrictMode

`StrictMode`, mentioned in [the chapter on files](#), can also report on performing network I/O on the main application thread. More importantly, on Android 4.0 and

higher, the emulator will, by default, crash your app if you try to perform network I/O on the main application thread.

Hence, it is generally a good idea to test your app, either using `StrictMode` yourself or using a suitable emulator, to make sure that you are not performing network I/O on the main application thread.

### What About HttpClient?

Android also contains a mostly-complete copy of version 4.0.2beta of the [Apache HttpClient library](#). Many developers use this, as they prefer the richer API offered by this library over the somewhat more clunky approach used by `java.net`. And, truth be told, this was the more stable option prior to Android 2.3.

There are a few reasons why this is no longer recommended, for Android 2.3 and beyond:

- The core Android team is better able to add capabilities to the `java.net` implementation while maintaining backwards compatibility, because its API is more narrow.
- The problems previously experienced on Android with the `java.net` implementation have largely been fixed.
- The Apache HttpClient project continuously evolves its API. This means that Android will continue to fall further and further behind the latest-and-greatest from Apache, as Android insists on maintaining the best possible backwards compatibility and therefore cannot take on newer-but-different HttpClient versions.

That being said, you are welcome to use HttpClient if you are not concerned about these limitations.

### HTTP via DownloadManager

If your objective is to download some large file, you may be better served by using the `DownloadManager` added to Android 2.3, as it handles a lot of low-level complexities for you. For example, if you start a download on WiFi, and the user leaves the building and the device fails over to some form of mobile data, you need to reconnect to the server and either start the download again or use some content negotiation to pick up from where you left off. `DownloadManager` handles that.

However, `DownloadManager` is dependent upon some broadcast Intent objects, a technique we have not discussed yet, so we will delay covering `DownloadManager` until [the next chapter](#).

## Using Third-Party JARs

To some extent, the best answer is to not write the code yourself, but rather use some existing JAR that handles both the Internet I/O and any required data parsing. This is commonplace when accessing public Web services — either because the firm behind the Web service has released a JAR, or because somebody in the community has released a JAR for that Web service.

Examples include:

- Using [JTwitter](#) to access Twitter's API
- Using [Amazon's JAR](#) to access various AWS APIs, including S3, SimpleDB, and SQS
- Using the [Dropbox SDK](#) for accessing DropBox folders and files

However, beyond the [classic potential JAR problems](#), you may encounter another when it comes to using JARs for accessing Internet services: versioning. For example:

- JTwitter bundles the `org.json` classes in its JAR, which will be superseded by Android's own copy, and if the JTwitter version of the classes have a different API, JTwitter could crash.
- Libraries dependent upon `HttpClient` might be dependent upon a version with a different API (e.g., 4.1.1) than is in Android (4.0.2 beta).

Try to find JARs that have been tested on Android and are clearly supported as such by their author. Lacking that, try to find JARs that are open source, so you can tweak their implementation if needed to add Android support.

## SSL

The traditional approach to securing HTTP operations is by means of SSL. Android supports SSL, much as ordinary Java does. Most of the time, you can just allow Android to do its thing with respect to SSL, and you will be fine. However, there may be times when you have to play a more direct role in SSL communications, to handle arbitrary SSL-encrypted endpoints, or to help ensure that your app is not the victim of a man-in-the-middle attack.



### Basic SSL Operation

Generally speaking, SSL “just works”, for ordinary sites with ordinary certificates.

If you use an `https:` URL with `URLConnection`, `HttpClient`, or `WebView`, SSL handshaking will happen automatically, and assuming the certificates check out OK, you will get your result, just as if you had requested an `http:` URL.

However, `DownloadManager` only recently added support for SSL. Originally, requesting a download via `DownloadManager` with an `https:` scheme would result in `java.lang.IllegalArgumentException: Can only download HTTP URIs`. As of Android 4.0, SSL is supported. Hence, you need to be careful about making SSL requests via `DownloadManager` to ensure that you are only doing that on a relatively recent version of Android.

### Certificate Verification

The first challenge comes in verifying the SSL certificate.

You can roughly divide SSL certificates into three types:

- Those issued by a certificate authority (CA) that is recognized by Android (e.g., VeriSign) or was issued by a downstream CA whose upstream CA is one recognized by Android
- Those issued by a CA that is not recognized by Android
- Self-signed certificates, whether used temporarily (e.g., during development) or in production

Android can only transparently handle the first set, where the root CA for the certificate is one recognized by Android. And, for better and for worse, the roster of CAs recognized by Android varies between OS versions, as Google updates the OS cacerts roster.

If you encounter an SSL certificate that cannot be verified by Android, you will get a `javax.net.ssl.SSLException: Not trusted server certificate exception` from `URLConnection` and `HttpClient`, and you will need to decide for yourself how to handle that.

### Custom TrustManager

The right solution is to build your own TrustManager that implements your business policies.

For example, if you want to validate a self-signed SSL certificate, you can implement a TrustManager that does so, by having a custom TrustStore. A TrustStore is a set of certificates (from a CA or self-signed) that a TrustManager can validate against. Nikolay Elenkov has [an excellent writeup and sample code](#) of implementing such a TrustStore. He also demonstrates how to have a composite TrustManager, one that uses the system's TrustManager and your own (e.g., configured with your custom TrustStore), so certificates that are validated by *either* TrustManager are considered to be valid.

If you are trying to use this technique to validate certificates from a CA that is not recognized by Android, you may need to use Mr. Elenkov's technique with multiple certificates, representing the upstream chain to the root CA.

### Wildcard Certificates

Some certificates are difficult to validate, because they use wildcards.

For example, Amazon S3 is a file storage and serving “cloud” solution from Amazon.com. They allow you to define “buckets” containing “objects”, where each object then has its own URL. That URL is based on the name of the bucket and the name of the object. One option is for you to have the domain name of the URL be based on the name of the bucket, leaving the path to be solely the name of the object. This works, even with SSL, but Amazon needed to use a “wildcard SSL certificate”, one that matches \*.s3.amazonaws.com, not just a single domain name. By default, this will fail on Android, as Android's stock TrustManager will not validate wildcards for multiple domain name segments (e.g., http://misc.commonsware.com.s3.amazonaws.com/foo.txt). You will get an exception akin to:

```
javax.net.ssl.SSLHandshakeException: java.security.cert.CertificateException:  
No subject alternative DNS name matching misc.commonsware.com.s3.amazonaws.com  
found
```

However, you could write a WildcardTrustManager or some such that relies on the system TrustManager to validate the rest of the certificate, while you validate the

domain name matches the expected value. The OpenDJ project has [a series of available TrustManager implementations](#), including one that supports wildcards.

### **Anti-Pattern: Disabling SSL Certificate Validation**

You will find various blog posts, StackOverflow answers, and the like that suggest that you simply disable SSL certificate validation, by implementing an “accept-all” TrustManager. Such a TrustManager basically implements the interface with empty stubs for methods like `checkServerTrusted()`, not throwing any exceptions.

Technically, this works. And, *if* you are using this only early on in development and *if* you swear upon a stack of \$RELIGIOUS\_TEXTS that you will replace this hack by the time you go to production, it is difficult to complain about this technique.

However, in production, ignoring SSL certificate validation errors opens your app up to man-in-the-middle attacks.

### **About That Man in the Middle**

Man-in-the-middle attacks are a common way of trying to intercept SSL encrypted communications. The “man” in the “middle” might be a proxy server, a different Web site you wind up communicating with via DNS poisoning, etc. The objective of the “man” is to pretend to be the actual Web site or Web service you are trying to communicate with. If your app “falls for it”, your app will open an encrypted channel to the attacker, not your site, and the attacker will have access to the unencrypted data you send over that channel.

Unfortunately, Android apps have a long history of being victims of man-in-the-middle attacks.

Fahl, Harbach, Muders, and Smith of the Leibniz University of Hannover, and Baumgärtner and Freisleben of the Philipps University of Marburg, conducted research on this problem. Their results, as reported in their paper, [“Why Eve and Mallory Love Android: An Analysis of Android SSL \(In\)Security”](#), is depressing. One in six surveyed apps explicitly ignored SSL certificate validation issues, mostly by means of do-nothing TrustManager implementations as noted above. Out of a selected 100 apps, 41 could be successfully attacked using man-in-the-middle techniques, yielding a treasure trove of credit card information, account credentials for all the major social networks, and so forth.

Their paper outlines a few ways in which apps can screw up SSL management — the following sections outline some of them.

### Disabling SSL Certificate Validation

As mentioned above, if you disable SSL certificate validation, by implementing and using a do-nothing TrustManager, you are wide open for man-in-the-middle attacks. A simple transparent proxy server can pretend to be the real endpoint — apps ignoring SSL validation entirely will trust that the transparent proxy is the real endpoint and, therefore, perform SSL key exchange with the proxy rather than the real site. The proxy, as a result, gets access to everything the app sends.

### Ignoring Domain Names

A related flaw is when you disable hostname verification. The “common name” (CN) of the SSL certificate should reflect the domain name being requested. Requesting `https://www.foo.com/something` and receiving an SSL certificate for `xkcdhatguy.com` would be indicative of a mis-configured Web server at best and a man-in-the-middle attack at worst.

By default, this is checked, and if there is no match, you will get errors like:

```
javax.net.ssl.SSLException: hostname in certificate didn't match: <...>
```

where the ... is replaced by whatever domain name you were requesting.

But some developers disable this check. Perhaps during development they were accessing the server using a private IP address, and they were getting SSLExceptions when trying to access that server. It is very important to allow Android to check the hostname for you, which is the default behavior.

### Hacked CAs

The truly scary issue is when the problem stems from the CA itself.

Comodo, TURKTRUST, and other certificate authorities have been hacked, where nefarious parties gained the ability to create arbitrary certificates backed by the CA. For example, in [the TURKTRUST case](#), Google found that somebody had created a \*.google.com certificate that had TURKTRUST as the root CA. Any browser — or Android app — that implicitly trusted TURKTRUST-issued certificates would

believe that this certificate was genuine. This is the ultimate in man-in-the-middle attacks, as code that is ordinarily fairly well-written will believe the CA and therefore happily communicate with the attacker.

### Certificate Memorizing

If your app needs to connect to arbitrary SSL servers — perhaps ones configured by the user (e.g., email client) or are intrinsic to the app's usage (e.g., URLs in a Web browser) — detecting man-in-the-middle attacks boils down to proper SSL certificate validation... and praying for no hacked CA certificates.

However, one way to incrementally improve security is to use certificate memorizing. With this technique, each time you see a certificate that you have not seen before, or perhaps a different certificate for a site visited previously, you ask the user to confirm that it is OK to proceed. Technically savvy users may be able to deduce whether the certificate is indeed genuine; slightly less-savvy users might simply contact the site to see if this is expected behavior. The downside is that technically unsophisticated users might be baffled by the question of whether or not they should accept the certificate and may take their confusion out on you, the developer of the app that is asking the question.

You can write your own `TrustManager` that maintains a roster of recognized certificates and takes steps for unrecognized ones. You can also try [an existing implementation of a memorizing `TrustManager`](#).

### Pinning

One way to limit the possible damage from hacked CAs is to recognize that most apps do not need to communicate with arbitrary servers. Web browsers, email clients, chat clients, and the like might need to be able to communicate with whatever server the user elects to configure. But many apps just need to communicate back to their developer's own server, such as a native client adjunct to a regular Web app.

In this case, the app does not need to accept arbitrary SSL certificates. The developer knows the actual SSL certificate used by the developer's server, so the developer can arrange to accept only that one certificate. Or, the developer knows the CA that they get their SSL certificates from and can only accept certificates issued by that CA, and not other CAs. This reduces security a bit, but makes it

easier for you to handle SSL certificate expiration and replacement without major headaches.

This technique is referred to as “[pinning](#)”. Chrome is perhaps the most well-known implementer of pinning: when you access services like Gmail from Chrome, Google (who wrote the browser) knows the valid certificates for Google (who wrote the server) and can toss out anything that is invalid... such as the TURKTRUST fake certificate mentioned earlier in this chapter.

Nikolay Elenkov has another [blog post](#) outlining certificate pinning support in Android 4.2. Moxie Marlinspike has an [implementation of pinning](#), with a description in a [blog post](#). And, the Guardian Project has an implementation of pinning in StrongTrustManager, discussed in the next section.

### OnionKit

[The Guardian Project](#) has released an Android library project called [OnionKit](#), designed to help boost Internet security for Android applications. It offers two major features: a replacement TrustManager called StrongTrustManager, and Tor integration.

StrongTrustManager offers pinning, as described in [the previous section](#), along with a custom set of root certificates, based upon the certificates used by the Debian Linux distribution. The custom set of root certificates addresses one annoyance with Android: Android’s set of root certificates varies by OS version (and, occasionally, by device due to changes from a device manufacturer). StrongTrustManager puts *you* in control of the root certificates that are used, so you can eliminate roots that you no longer trust (e.g., TURKTRUST), as you can tailor the root certificates that StrongTrustManager uses by means of [the CACertMan utility](#), also published by the Guardian Project.

OnionKit takes matters a step farther and helps your application integrate with Orbot, a Tor proxy. [Tor \(“The Onion Router”\)](#) is designed to help with anonymity, having your Internet requests go through a series of Tor routers before actually connecting to your targeted server through some Tor endpoint. Tor is used for everything from mitigating Web site tracking to helping dissidents bypass national firewalls. OnionKit helps your app:

- Detect if Orbot is installed, and help the user install it if it is not
- Detect if Orbot is running, and help you start it if it is not

## INTERNET ACCESS

---

- Make HTTP requests by means of Orbot instead of directly over the Internet

Note that we will see the Guardian Project again later in this book, as they were the initial developers of [SQLCipher for Android](#), a means by which you can readily use an encrypted database in your Android apps.

# Intents, Intent Filters, Broadcasts, and Broadcast Receivers

---

We have seen Intent objects briefly, in our discussion of [having multiple activities in our application](#). However, we really did not dive into too much of the details about those Intent objects, and they can be used in other ways besides starting up an activity. In this chapter, we will examine Intent and their filters, plus another channel of the Intent message bus: the broadcast Intent.

## What’s Your Intent?

When Sir Tim Berners-Lee cooked up the Hypertext Transfer Protocol — HTTP — he set up a system of verbs plus addresses in the form of URLs. The address indicated a resource, such as a Web page, graphic, or server-side program. The verb indicated what should be done: GET to retrieve it, POST to send form data to it for processing, etc.

An Intent is similar, in that it represents an action plus context. There are more actions and more components to the context with Intent than there are with HTTP verbs and resources, but the concept is still the same.

Just as a Web browser knows how to process a verb+URL pair, Android knows how to find activities or other application logic that will handle a given Intent.

## Pieces of Intents

The two most important pieces of an Intent are the action and what Android refers to as the “data”. These are almost exactly analogous to HTTP verbs and URLs — the action is the verb, and the “data” is a `Uri`, such as `http://commonsware.com`



representing an HTTP URL to some balding guy's Web site. Actions are constants, such as `ACTION_VIEW` (to bring up a viewer for the resource) or `ACTION_EDIT` (to edit the resource).

If you were to create an Intent combining `ACTION_VIEW` with a content Uri of `http://commonsware.com`, and pass that Intent to Android via `startActivity()`, Android would know to find and open an activity capable of viewing that resource.

There are other criteria you can place inside an Intent, besides the action and “data” Uri, such as:

1. Categories. Your “main” activity will be in the `LAUNCHER` category, indicating it should show up on the launcher menu. Other activities will probably be in the `DEFAULT` or `ALTERNATIVE` categories.
2. A MIME type, indicating the type of resource you want to operate on.
3. A component, which is to say, the class of the activity that is supposed to receive this Intent.
4. “Extras”, which is a `Bundle` of other information you want to pass along to the receiver with the Intent, that the recipient might want to take advantage of. What pieces of information a given recipient can use is up to the recipient and (hopefully) is well-documented.

You will find rosters of the standard actions, categories, and extras in the Android SDK documentation for the Intent class.

### Intent Routing

As noted above, if you specify the target component in your Intent, Android has no doubt where the Intent is supposed to be routed to — it will launch the named activity. This might be OK if the target recipient (e.g., the activity to be started) is in your application. It definitely is not recommended for invoking functionality in other applications. Component names, by and large, are considered private to the application and are subject to change. Actions, Uri templates, and MIME types are the preferred ways of identifying capabilities you wish third-party code to supply.

If you do not specify the target component, then Android has to figure out what recipients are eligible to receive the Intent. For example, Android will take the Intent you supply to `startActivity()` and find the activities that might support it. Note the use of the plural “activities”, as a broadly-written intent might well resolve to several activities. That is the... ummm... intent (pardon the pun), as you will see [later in this chapter](#). This routing approach is referred to as implicit routing.

Basically, there are three rules, all of which must be true for a given activity to be eligible for a given Intent:

- The activity must support the specified action
- The activity must support the stated MIME type (if supplied)
- The activity must support all of the categories named in the Intent

The upshot is that you want to make your Intent specific enough to find the right recipient, and no more specific than that.

This will become clearer as we work through some examples throughout this chapter.

### Stating Your Intent(ions)

All Android components that wish to be started via an Intent must declare Intent filters, so Android knows which intents should go to that component. A common approach for this is to add one or more `<intent-filter>` elements to your `AndroidManifest.xml` file, inside the element for the component that should respond to the Intent.

For example, all of the sample projects in this book have an `<intent-filter>` on an `<activity>` that looks like this:

```
<intent-filter>  
  <action android:name="android.intent.action.MAIN" />  
  <category android:name="android.intent.category.LAUNCHER" />  
</intent-filter>
```

Here, we declare that this activity:

1. Is the main activity for this application
2. It is in the LAUNCHER category, meaning it gets an icon in anything that thinks of itself as a “launcher”, such as the home screen

You are welcome to have more than one action or more than one category in your Intent filters. That indicates that the associated component (e.g., activity) handles multiple different sorts of Intent patterns.

## Responding to Implicit Intents

We saw in the chapter on multiple activities how one activity can start another via an explicit Intent, identifying the particular activity to be started:

```
startActivity(new Intent(this, OtherActivity.class));
```

In that case, OtherActivity does not need an `<intent-filter>` in the manifest. It will automatically respond when somebody explicitly identifies it as the desired activity.

However, what if you want to respond to an implicit Intent, one that focuses on an action string and other values? Then you *will* need an `<intent-filter>` in the manifest.

For example, take a look at the [Intents/FauxSender](#) sample project.

Here, we have an activity, FauxSender, set up to respond to an ACTION\_SEND Intent, specifically for content that has the MIME type of text/plain:

```
<activity
  android:name="FauxSender"
  android:label="@string/app_name"
  android:theme="@android:style/Theme.NoDisplay">
  <intent-filter android:label="@string/app_name">
    <action android:name="android.intent.action.SEND"/>

    <data android:mimeType="text/plain"/>

    <category android:name="android.intent.category.DEFAULT"/>
  </intent-filter>
</activity>
```

The call to `startActivity()` will always add the DEFAULT category if no other category is specified, which is why our `<intent-filter>` also filters on that category.

Hence, if somebody on the system calls `startActivity()` on an ACTION\_SEND Intent with a MIME type of text/plain, our FauxSender activity might get control. We will explain the use of the term “might” in the next section.

The [documentation for ACTION\\_SEND](#) indicates that a standard extra on the Intent is EXTRA\_TEXT, representing the text to be sent. There might also be an EXTRA\_SUBJECT, representing a subject line, if the “send” operation might have such a concept, such as an email client.

## INTENTS, INTENT FILTERS, BROADCASTS, AND BROADCAST RECEIVERS

---

FauxSender can retrieve those extras and make use of them:

```
package com.commonware.android.fsender;

import android.app.Activity;
import android.content.Intent;
import android.os.Bundle;
import android.text.TextUtils;
import android.widget.Toast;

public class FauxSender extends Activity {
    @Override
    public void onCreate(Bundle savedInstanceState) {
        super.onCreate(savedInstanceState);

        String msg=getIntent().getStringExtra(Intent.EXTRA_TEXT);

        if (TextUtils.isEmpty(msg)) {
            msg=getIntent().getStringExtra(Intent.EXTRA_SUBJECT);
        }

        if (TextUtils.isEmpty(msg)) {
            Toast.makeText(this, R.string.no_message_supplied,
                Toast.LENGTH_LONG).show();
        }
        else {
            Toast.makeText(this, msg, Toast.LENGTH_LONG).show();
        }

        finish();
    }
}
```

Here, we use `TextUtils.isEmpty()` to detect if an extra is either null or has an empty string as its value. If `EXTRA_TEXT` is supplied, we show it in a Toast. Otherwise, we use `EXTRA_SUBJECT` if it is supplied, and if that is also missing, we show a stock message from a string resource.

The activity then immediately calls `finish()` from `onCreate()` to get rid of itself. That, coupled with `android:theme="@android:style/Theme.NoDisplay"` in the `<activity>` element, means that the activity will have no user interface, beyond the Toast. If run from the launcher, you will still see the launcher behind the Toast:

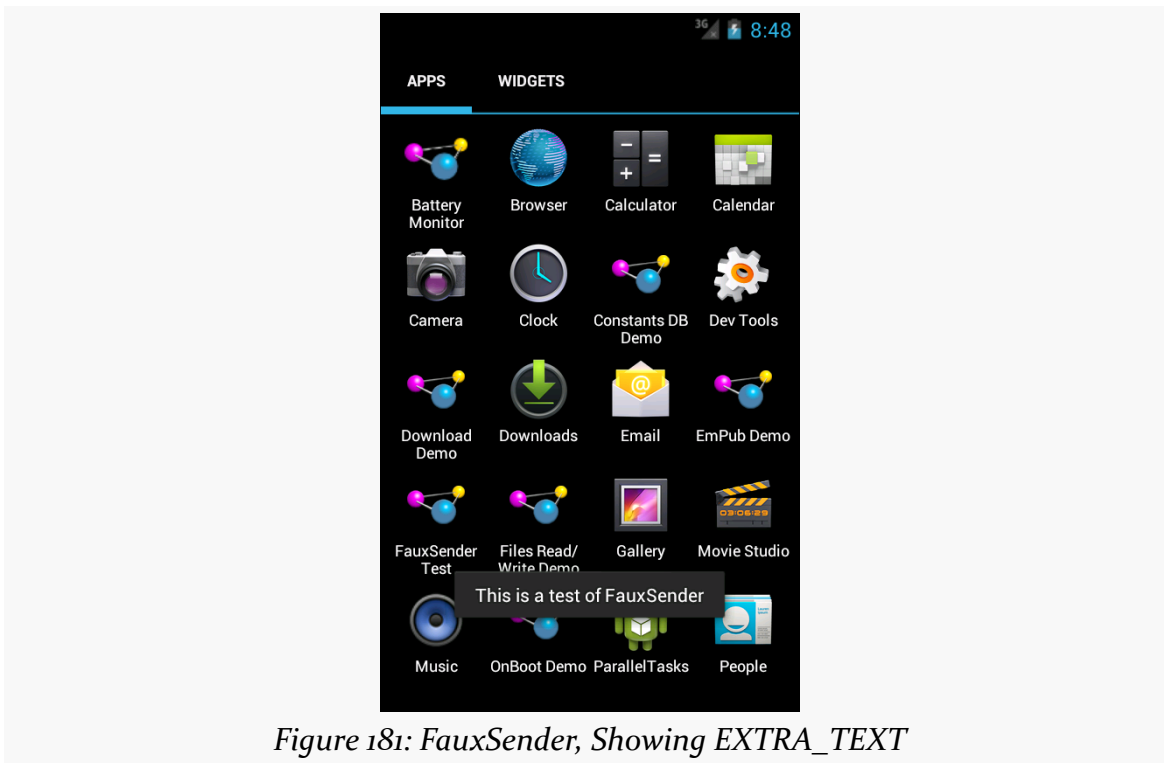


Figure 181: FauxSender, Showing EXTRA\_TEXT

## Requesting Implicit Intents

To send something via ACTION\_SEND, you first set up the Intent, containing whatever information you want to send in EXTRA\_TEXT, such as this code from the FauxSenderTest activity:

```
Intent i=new Intent(Intent.ACTION_SEND);  
i.setType("text/plain");  
i.putExtra(Intent.EXTRA_SUBJECT, R.string.share_subject);  
i.putExtra(Intent.EXTRA_TEXT, theMessage);
```

(where theMessage is a passed-in parameter to the method containing this code fragment)

If we call startActivity() on this Intent directly, there are three possible outcomes, described in the following sections.

### Zero Matches

It is possible, though unlikely, that there are no activities at all on the device that will be able to handle this Intent. In that case, we crash with an `ActivityNotFoundException`. This is a `RuntimeException`, which is why we do not have to keep wrapping all our `startActivity()` calls in `try/catch` blocks. However, if we might start something that does not exist, we really should catch that exception... or avoid the call in the first place. Detecting up front whether there will be any matches for our activity is a topic that will be discussed later in this book.

### One Match

It is possible that there will be exactly one matching activity. In that case, the activity in question starts up and takes over the foreground. This is what we see with the explicit Intent.

### Many Matches, Default Behavior

It is possible that there will be more than one matching activity. In that case, by default, the user will be presented with a so-called “chooser” dialog box:

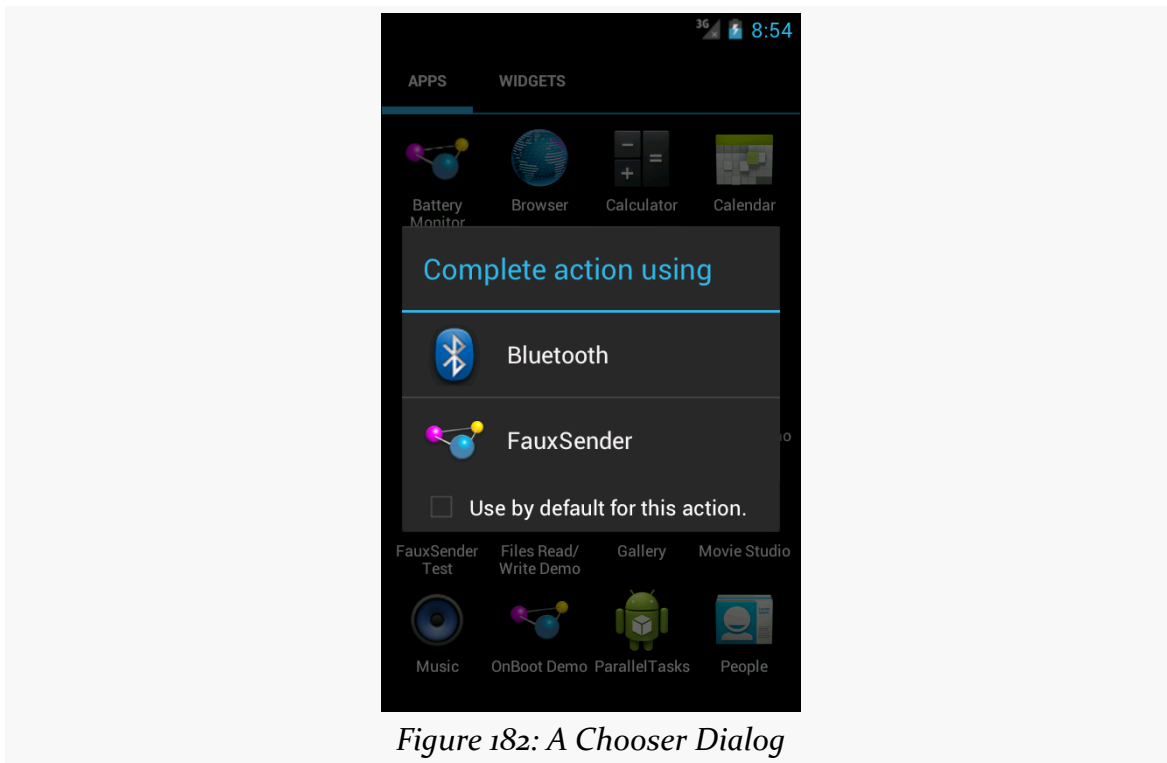


Figure 182: A Chooser Dialog

The user can tap on either of those two items in the list to have that particular activity be the one to process this event. And, if the user checks the “Use by default for this action” checkbox, and we invoke the same basic Intent again (same action, same MIME type, same categories, same Uri scheme), whatever the user chooses *now* will be used again automatically, bypassing the chooser.

### The Chooser Override

For many Intent patterns, the notion of the user choosing a default makes perfect sense. For example, if the user installs another Web browser, until they check that checkbox, every time they go to view a Web page, they will be presented with a chooser, to choose among the installed browsers. This can get annoying quickly.

However, ACTION\_SEND is one of those cases where the default checkbox is usually inappropriate. Just because the user on Monday chose to send something via Bluetooth and accidentally checked that checkbox does not mean that every day thereafter, they *always* want *every* ACTION\_SEND to go via Bluetooth, instead of Gmail or Email or Facebook or Twitter or any other ACTION\_SEND-capable apps they may have installed.

## INTENTS, INTENT FILTERS, BROADCASTS, AND BROADCAST RECEIVERS

---

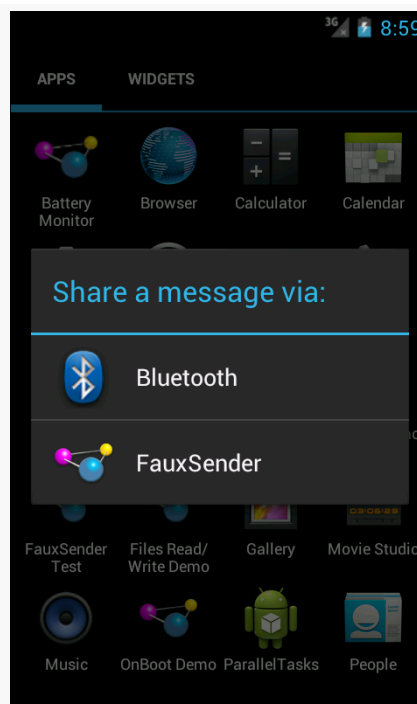
You can elect to force a chooser to display, regardless of the state of that checkbox. To do this, instead of calling `startActivity()` on the Intent directly, you wrap the Intent in another Intent returned by the `createChooser()` static method on Intent itself:

```
void sendIt(String theMessage) {
    Intent i=new Intent(Intent.ACTION_SEND);

    i.setType("text/plain");
    i.putExtra(Intent.EXTRA_SUBJECT, R.string.share_subject);
    i.putExtra(Intent.EXTRA_TEXT, theMessage);

    startActivity(Intent.createChooser(i,
        getString(R.string.share_title)));
}
```

The second parameter to `createChooser()` is a message to appear at the top of the dialog box:



*Figure 183: Your Tailored Chooser Dialog*

Notice the lack of the default checkbox — not only must the user make a choice now, but also they cannot make a default choice for the future, either.



## Broadcasts and Receivers

One channel of the Intent message bus is used to start activities. A second channel of the Intent message bus is used to send broadcasts. As the name suggests, a broadcast Intent is one that — by default — is published to any and all applications on the device that wish to tune in.

### Sending a Simple Broadcast

The simplest way to send a broadcast Intent is to create the Intent you want, then call `sendBroadcast()`.

That's it.

At that point, Android will scan through everything set up to tune into a broadcast matching your Intent, typically filtering just on the action string. Anyone set up to receive this broadcast will, indeed, receive it, using a `BroadcastReceiver`.

### Receiving a Broadcast: In an Activity

To receive such a broadcast in an activity, you will need to do four things.

First, you will need to create an instance of your own subclass of `BroadcastReceiver`. The only method you need to (or should) implement is `onReceive()`, which will be passed the Intent that was broadcast, along with a `Context` object that, in this case, you will typically ignore.

Second, you will need to create an instance of an `IntentFilter` object, describing the sorts of broadcasts you want to receive. Most of these filters are set up to watch for a single broadcast Intent action, in which case the simple constructor suffices:

```
new IntentFilter(ACTION_CAMERA_BUTTON)
```

Third, you will need to call `registerReceiver()`, typically from `onResume()` of your activity or fragment, supplying your `BroadcastReceiver` and your `IntentFilter`.

Fourth, you will need to call `unregisterReceiver()`, typically from `onPause()` of your activity or fragment, supplying the same `BroadcastReceiver` instance you provided to `registerReceiver()`.

In between the calls to `registerReceiver()` and `unregisterReceiver()`, you will receive any broadcasts matching the `IntentFilter`.

The biggest downside to this approach is that some activity has to register the receiver. Sometimes, you want to receive broadcasts even when there is no activity around. To do that, you will need to use a different technique: registering the receiver in the manifest.

### Receiving a Broadcast: Via the Manifest

You can also tell Android about broadcasts you wish to receive by adding a `<receiver>` element to your manifest, identifying the class that implements your `BroadcastReceiver` (via the `android:name` attribute), plus an `<intent-filter>` that describes the broadcast(s) you wish to receive.

The good news is that this `BroadcastReceiver` will be available for broadcasts occurring at any time. There is no assumption that you have an activity already running that called `registerReceiver()`.

The bad news is that the instance of the `BroadcastReceiver` used by Android to process a broadcast will live for only so long as it takes to execute the `onReceive()` method. At that point, the `BroadcastReceiver` is discarded. Hence, it is not safe for a manifest-registered `BroadcastReceiver` to do anything that needs to run after `onReceive()` itself processes, such as forking a thread.

More bad news: `onReceive()` is called on the main application thread — the same main application thread that handles the UI of all of your activities. And, you are subject to the same limitations as are your activity lifecycle methods and anything else called on the main application thread:

- Any time spent in `onReceive()` will freeze your UI, if you happen to have a foreground activity
- If you spend too long in `onReceive()`, Android will terminate your `BroadcastReceiver` without waiting for `onReceive()` to complete

This makes using a manifest-registered `BroadcastReceiver` a bit tricky. If the work to be done is very quick, just implement it in `onReceive()`. Otherwise, you will probably need to pair this `BroadcastReceiver` with a component known as an `IntentService`, which we will examine [in the next chapter](#).

## Example System Broadcasts

There are many, many broadcasts sent out by Android itself, which you can tune into if you see fit. Many, but not all, of these are documented on the `Intent` class. The values in the “Constants” table that have “Broadcast Action” leading off their description are action strings used for system broadcasts. There are other such broadcast actions scattered around the SDK, though, so do not assume that they are all documented on `Intent`.

The following sections will examine two of these broadcasts, to see how the `BroadcastReceiver` works in action.

### At Boot Time

A popular request is to have code get control when the device is powered on. This is doable but somewhat dangerous, in that too many on-boot requests slow down the device startup and may make things sluggish for the user.

In order to be notified when the device has completed its system boot process, you will need to request the `RECEIVE_BOOT_COMPLETED` permission. Without this, even if you arrange to receive the boot broadcast `Intent`, it will not be dispatched to your receiver.

As the Android documentation describes it:

Though holding this permission does not have any security implications, it can have a negative impact on the user experience by increasing the amount of time it takes the system to start and allowing applications to have themselves running without the user being aware of them. As such, you must explicitly declare your use of this facility to make that visible to the user.

We also need to register our `BroadcastReceiver` in the manifest — by the time an activity would call `registerReceiver()`, the boot will have long since occurred.

For example, let us examine the [Intents/OnBoot](#) sample project.

In our manifest, we request the needed permission and register our `BroadcastReceiver`, along with an activity:

## INTENTS, INTENT FILTERS, BROADCASTS, AND BROADCAST RECEIVERS

---

```
<?xml version="1.0" encoding="utf-8"?>
<manifest xmlns:android="http://schemas.android.com/apk/res/android"
    package="com.commonware.android.sysevents.boot"
    android:versionCode="1"
    android:versionName="1.0">

    <uses-sdk
        android:minSdkVersion="7"
        android:targetSdkVersion="11"/>

    <supports-screens
        android:largeScreens="false"
        android:normalScreens="true"
        android:smallScreens="false"/>

    <uses-permission android:name="android.permission.RECEIVE_BOOT_COMPLETED"/>

    <application
        android:icon="@drawable/ic_launcher"
        android:label="@string/app_name">
        <receiver android:name=".OnBootReceiver">
            <intent-filter>
                <action android:name="android.intent.action.BOOT_COMPLETED"/>
            </intent-filter>
        </receiver>

        <activity
            android:name="BootstrapActivity"
            android:theme="@android:style/Theme.NoDisplay">
            <intent-filter>
                <action android:name="android.intent.action.MAIN"/>

                <category android:name="android.intent.category.LAUNCHER"/>
            </intent-filter>
        </activity>
    </application>
</manifest>
```

The OnBootCompleted BroadcastReceiver simply logs a message to LogCat:

```
package com.commonware.android.sysevents.boot;

import android.content.BroadcastReceiver;
import android.content.Context;
import android.content.Intent;
import android.util.Log;

public class OnBootReceiver extends BroadcastReceiver {
    @Override
    public void onReceive(Context context, Intent intent) {
        Log.d(getClass().getSimpleName(), "Hi, Mom!");
    }
}
```

```
}  
}
```

To test this on Android 3.0 and earlier, simply install the application and reboot the device — you will see the message appear in LogCat.

However, on Android 3.1 and higher, the user must first manually launch some activity before any manifest-registered `BroadcastReceiver` objects will be used. Hence, if you were to just install the application and reboot the device, nothing would happen. The little `BootstrapActivity` is merely there for the user to launch, so that the `ACTION_BOOT_COMPLETED` `BroadcastReceiver` will start working.

### On Battery State Changes

One theme with system events is to use them to help make your users happier by reducing your impacts on the device while the device is not in a great state. Most applications are impacted by battery life. Dead batteries run no apps. Hence, knowing the battery level may be important for your app.

There is an `ACTION_BATTERY_CHANGED` Intent that gets broadcast as the battery status changes, both in terms of charge (e.g., 80% charged) and charging (e.g., the device is now plugged into AC power). You simply need to register to receive this Intent when it is broadcast, then take appropriate steps.

One of the limitations of `ACTION_BATTERY_CHANGED` is that you have to use `registerReceiver()` to set up a `BroadcastReceiver` to get this Intent when broadcast. You cannot use a manifest-declared receiver. There are separate `ACTION_BATTERY_LOW` and `ACTION_BATTERY_OK` broadcasts that you *can* receive from a manifest-registered receiver, but they are broadcast far less frequently, only when the battery level falls below or rises above some undocumented “low” threshold.

To demonstrate `ACTION_BATTERY_CHANGED`, take a peek at the [Intents/OnBattery](#) sample project.

In there, you will find a `res/layout/batt.xml` resource containing a `ProgressBar`, a `TextView`, and an `ImageView`, to serve as a battery monitor:

```
<?xml version="1.0" encoding="utf-8"?>  
<LinearLayout xmlns:android="http://schemas.android.com/apk/res/android"  
    android:layout_width="match_parent"  
    android:layout_height="match_parent"  
    android:orientation="vertical">
```

## INTENTS, INTENT FILTERS, BROADCASTS, AND BROADCAST RECEIVERS

---

```
<ProgressBar
    android:id="@+id/bar"
    style="?android:attr/progressBarStyleHorizontal"
    android:layout_width="match_parent"
    android:layout_height="wrap_content"/>

<LinearLayout
    android:layout_width="match_parent"
    android:layout_height="wrap_content"
    android:orientation="horizontal">

    <TextView
        android:id="@+id/level"
        android:layout_width="0px"
        android:layout_height="wrap_content"
        android:layout_weight="1"
        android:textSize="16pt"/>

    <ImageView
        android:id="@+id/status"
        android:layout_width="0px"
        android:layout_height="wrap_content"
        android:layout_weight="1"/>
</LinearLayout>
</LinearLayout>
```

This layout is used by a BatteryFragment, which registers to receive the ACTION\_BATTERY\_CHANGED Intent in onResume() and unregisters in onPause():

```
package com.commonware.android.battmon;

import android.content.BroadcastReceiver;
import android.content.Context;
import android.content.Intent;
import android.content.IntentFilter;
import android.os.BatteryManager;
import android.os.Bundle;
import android.view.LayoutInflater;
import android.view.View;
import android.view.ViewGroup;
import android.widget.ImageView;
import android.widget.ProgressBar;
import android.widget.TextView;
import com.actionbarsherlock.app.SherlockFragment;

public class BatteryFragment extends SherlockFragment {
    private ProgressBar bar=null;
    private ImageView status=null;
    private TextView level=null;

    @Override
    public View onCreateView(LayoutInflater inflater, ViewGroup parent,
```

## INTENTS, INTENT FILTERS, BROADCASTS, AND BROADCAST RECEIVERS

---

```
        Bundle savedInstanceState) {
    View result=inflater.inflate(R.layout.batt, parent, false);

    bar=(ProgressBar)result.findViewById(R.id.bar);
    status=(ImageView)result.findViewById(R.id.status);
    level=(TextView)result.findViewById(R.id.level);

    return(result);
}

@Override
public void onResume() {
    super.onResume();

    IntentFilter f=new IntentFilter(Intent.ACTION_BATTERY_CHANGED);

    getActivity().registerReceiver(onBattery, f);
}

@Override
public void onPause() {
    getActivity().unregisterReceiver(onBattery);

    super.onPause();
}

BroadcastReceiver onBattery=new BroadcastReceiver() {
    public void onReceive(Context context, Intent intent) {
        int pct=
            100 * intent.getIntExtra(BatteryManager.EXTRA_LEVEL, 1)
            / intent.getIntExtra(BatteryManager.EXTRA_SCALE, 1);

        bar.setProgress(pct);
        level.setText(String.valueOf(pct));

        switch (intent.getIntExtra(BatteryManager.EXTRA_STATUS, -1)) {
            case BatteryManager.BATTERY_STATUS_CHARGING:
                status.setImageResource(R.drawable.charging);
                break;

            case BatteryManager.BATTERY_STATUS_FULL:
                int plugged=
                    intent.getIntExtra(BatteryManager.EXTRA_PLUGGED, -1);

                if (plugged == BatteryManager.BATTERY_PLUGGED_AC
                    || plugged == BatteryManager.BATTERY_PLUGGED_USB) {
                    status.setImageResource(R.drawable.full);
                }
                else {
                    status.setImageResource(R.drawable.unplugged);
                }
                break;

            default:
```

## INTENTS, INTENT FILTERS, BROADCASTS, AND BROADCAST RECEIVERS

---

```
        status.setImageResource(R.drawable.unplugged);
        break;
    }
}
};
}
```

The key to ACTION\_BATTERY\_CHANGED is in the “extras”. Many extras are packaged in the Intent, to describe the current state of the battery, such as the following constants defined on the BatteryManager class:

- EXTRA\_HEALTH, which should generally be BATTERY\_HEALTH\_GOOD
- EXTRA\_LEVEL, which is the proportion of battery life remaining as an integer, specified on the scale described by the EXTRA\_SCALE value
- EXTRA\_PLUGGED, which will indicate if the device is plugged into AC power (BATTERY\_PLUGGED\_AC) or USB power (BATTERY\_PLUGGED\_USB)
- EXTRA\_SCALE, which indicates the maximum possible value of level (e.g., 100, indicating that level is a percentage of charge remaining)
- EXTRA\_STATUS, which will tell you if the battery is charging (BATTERY\_STATUS\_CHARGING), full (BATTERY\_STATUS\_FULL), or discharging (BATTERY\_STATUS\_DISCHARGING)
- EXTRA\_TECHNOLOGY, which indicates what sort of battery is installed (e.g., "Li-Ion")
- EXTRA\_TEMPERATURE, which tells you how warm the battery is, in tenths of a degree Celsius (e.g., 213 is 21.3 degrees Celsius)
- EXTRA\_VOLTAGE, indicating the current voltage being delivered by the battery, in millivolts

In the case of BatteryFragment, when we receive an ACTION\_BATTERY\_CHANGED Intent, we do three things:

1. We compute the percentage of battery life remaining, by dividing the level by the scale
2. We update the ProgressBar and TextView to display the battery life as a percentage
3. We display an icon, with the icon selection depending on whether we are charging (status is BATTERY\_STATUS\_CHARGING), full but on the charger (status is BATTERY\_STATUS\_FULL and plugged is BATTERY\_PLUGGED\_AC or BATTERY\_PLUGGED\_USB), or are not plugged in

If you plug this into a device, it will show you the device’s charge level:



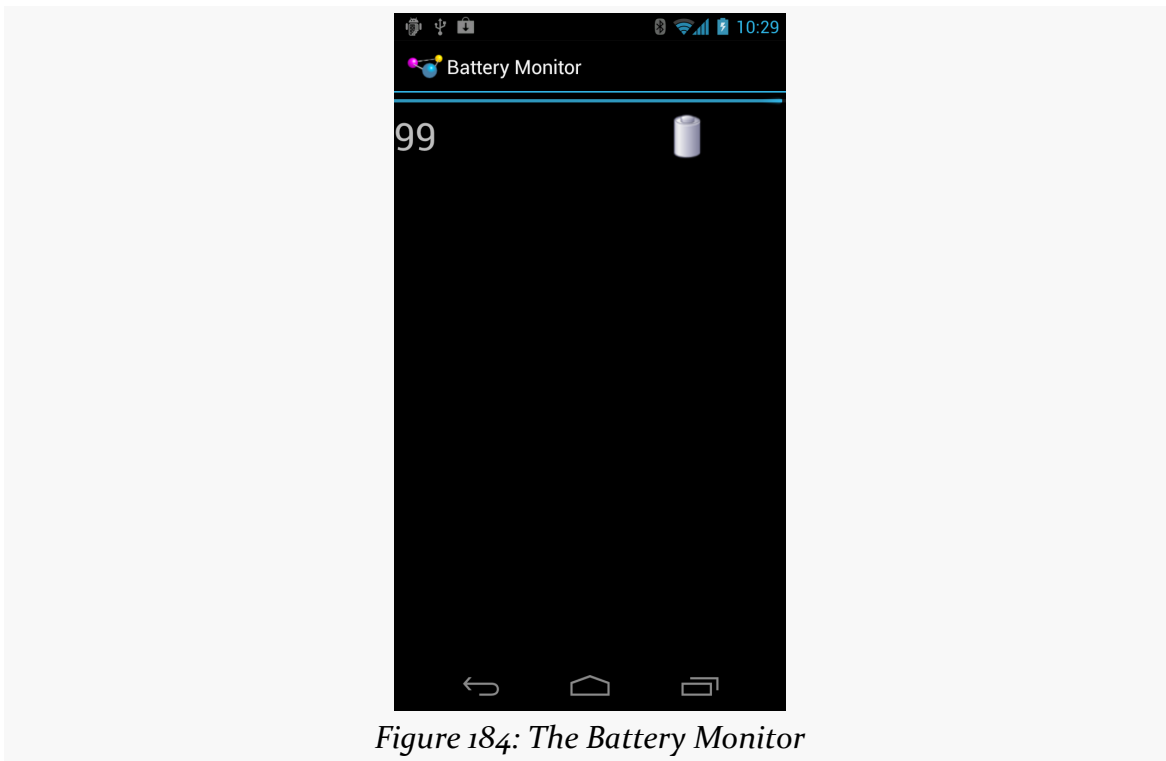


Figure 184: The Battery Monitor

### Sticky Intents and the Battery

Android has a notion of “sticky broadcast Intents”. Normally, a broadcast Intent will be delivered to interested parties and then discarded. A sticky broadcast Intent is delivered to interested parties and retained until the next matching Intent is broadcast. Applications can call `registerReceiver()` with an `IntentFilter` that matches the sticky broadcast, but with a null `BroadcastReceiver`, and get the sticky Intent back as a result of the `registerReceiver()` call.

This may sound confusing. Let’s look at this in the context of the battery.

Earlier in this section, you saw how to register for `ACTION_BATTERY_CHANGED` to get information about the battery delivered to you. You can also, though, get the latest battery information without registering a receiver. Just create an `IntentFilter` to match `ACTION_BATTERY_CHANGED` (as shown above) and call `registerReceiver()` with that filter and a null `BroadcastReceiver`. The Intent you get back from `registerReceiver()` is the last `ACTION_BATTERY_CHANGED` Intent that was broadcast, with the same extras. Hence, you can use this to get the current (or near-current) battery status, rather than having to bother registering an actual `BroadcastReceiver`.

### Battery and the Emulator

Your emulator does not really have a battery. If you run this sample application on an emulator, you will see, by default, that your device has 50% fake charge remaining and that it is being charged. However, it is charged infinitely slowly, as it will not climb past 50%... at least, not without help.

While the emulator will only show fixed battery characteristics, you can change what those values are, through the highly advanced user interface known as `telnet`.

You may have noticed that your emulator title bar consists of the name of your AVD plus a number, frequently 5554. That number is not merely some engineer's favorite number. It is also an open port, on your emulator, to which you can `telnet` into, on `localhost` (127.0.0.1) on your development machine.

There are many commands you can issue to the emulator by means of `telnet`. To change the battery level, use `power capacity NN`, where `NN` is the percentage of battery life remaining that you wish the emulator to return. If you do that while you have an `ACTION_BATTERY_CHANGED` `BroadcastReceiver` registered, the receiver will receive a broadcast `Intent`, informing you of the change.

You can also experiment with some of the other power subcommands (e.g., `power ac on` or `power ac off`), or other commands (e.g., `geo`, to send simulated GPS fixes, just as you can do from `DDMS`).

### Downloading Files

Android 2.3 introduced a `DownloadManager`, designed to handle a lot of the complexities of downloading larger files, such as:

1. Determining whether the user is on WiFi or mobile data, and if so, whether the download should occur
2. Handling when the user, previously on WiFi, moves out of range of the access point and “fails over” to mobile data
3. Ensuring the device stays awake while the download proceeds

`DownloadManager` itself is less complicated than the alternative of writing all of it yourself. However, it does present a few challenges. In this section, we will examine the [Internet/Download](#) sample project, one that uses `DownloadManager`.

### The Permissions

To use `DownloadManager`, you will need to hold the `INTERNET` permission. You will also need the `WRITE_EXTERNAL_STORAGE` permission, as `DownloadManager` can only download to external storage.

For example, here is the manifest for the Internet/Download application, where we request these two permissions:

```
<?xml version="1.0" encoding="utf-8"?>
<manifest xmlns:android="http://schemas.android.com/apk/res/android"
    package="com.commonware.android.downmgr"
    android:versionCode="1"
    android:versionName="1.0">

    <supports-screens
        android:anyDensity="true"
        android:largeScreens="true"
        android:normalScreens="true"
        android:smallScreens="true"/>

    <uses-sdk
        android:minSdkVersion="9"
        android:targetSdkVersion="14"/>

    <uses-permission android:name="android.permission.INTERNET"/>
    <uses-permission android:name="android.permission.WRITE_EXTERNAL_STORAGE"/>

    <application
        android:icon="@drawable/ic_launcher"
        android:label="@string/app_name"
        android:theme="@style/Theme.Sherlock">
        <activity
            android:name=".DownloadDemo"
            android:label="@string/app_name">
            <intent-filter>
                <action android:name="android.intent.action.MAIN"/>

                <category android:name="android.intent.category.LAUNCHER"/>
            </intent-filter>
        </activity>
    </application>
</manifest>
```

Note that the manifest also has `android:minSdkVersion="9"`, because that was the API level in which the `DownloadManager` was introduced.

## The Layout

Our sample application has a simple layout, consisting of three buttons:

1. One to kick off a download
2. One to query the status of a download
3. One to display a system-supplied activity containing the roster of downloaded files

```
<?xml version="1.0" encoding="utf-8"?>
<LinearLayout
  xmlns:android="http://schemas.android.com/apk/res/android"
  android:orientation="vertical"
  android:layout_width="fill_parent"
  android:layout_height="fill_parent"
  >
  <Button
    android:id="@+id/start"
    android:text="@string/start_download"
    android:layout_width="fill_parent"
    android:layout_height="0dip"
    android:layout_weight="1"
  />
  <Button
    android:id="@+id/query"
    android:text="@string/query_status"
    android:layout_width="fill_parent"
    android:layout_height="0dip"
    android:layout_weight="1"
    android:enabled="false"
  />
  <Button android:id="@+id/view"
    android:text="@string/view_log"
    android:layout_width="fill_parent"
    android:layout_height="0dip"
    android:layout_weight="1"
  />
</LinearLayout>
```

## Requesting the Download

To kick off a download, we first need to get access to the `DownloadManager`. This is a so-called “system service”. You can call `getSystemService()` on any activity (or other `Context`), provide it the identifier of the system service you want, and receive the system service object back. However, since `getSystemService()` supports a wide range of these objects, you need to cast it to the proper type for the service you requested.

## INTENTS, INTENT FILTERS, BROADCASTS, AND BROADCAST RECEIVERS

---

So, for example, here is a line from `onCreateView()` of the `DownloadFragment` where we get the `DownloadManager`:

```
@Override
public View onCreateView(LayoutInflater inflater, ViewGroup parent,
                        Bundle savedInstanceState) {
    mgr=
(DownloadManager) getActivity().getSystemService(Context.DOWNLOAD_SERVICE);

    View result=inflater.inflate(R.layout.main, parent, false);

    query=result.findViewById(R.id.query);
    query.setOnClickListener(this);
    start=result.findViewById(R.id.start);
    start.setOnClickListener(this);

    result.findViewById(R.id.view).setOnClickListener(this);

    return(result);
}
```

Most of these managers have no `close()` or `release()` or `goAwayPlease()` sort of methods — you can just use them and let garbage collection take care of cleaning them up.

Given the manager, we can now call an `enqueue()` method to request a download. The name is relevant — do not assume that your download will begin immediately, though often times it will. The `enqueue()` method takes a `DownloadManager.Request` object as a parameter. The `Request` object uses the builder pattern, in that most methods return the `Request` itself, so you can chain a series of calls together with less typing.

For example, the top-most button in our layout is tied to a `startDownload()` method in `DownloadFragment`, shown below:

```
private void startDownload(View v) {
    Uri uri=Uri.parse("http://commonsware.com/misc/test.mp4");

    Environment.getExternalStoragePublicDirectory(Environment.DIRECTORY_DOWNLOADS)
        .mkdirs();

    DownloadManager.Request req=new DownloadManager.Request(uri);

    req.setAllowedNetworkTypes(DownloadManager.Request.NETWORK_WIFI
                               | DownloadManager.Request.NETWORK_MOBILE)
        .setAllowedOverRoaming(false)
        .setTitle("Demo");
}
```

```
.setDescription("Something useful. No, really.")
.setDestinationInExternalPublicDir(Environment.DIRECTORY_DOWNLOADS,
    "test.mp4");

lastDownload=mgr.enqueue(req);
```

We are downloading a sample MP4 file, and we want to download it to the external storage area. To do the latter, we are using `getExternalStoragePublicDirectory()` on `Environment`, which gives us a directory suitable for storing a certain class of content. In this case, we are going to store the download in the `Environment.DIRECTORY_DOWNLOADS`, though we could just as easily have chosen `Environment.DIRECTORY_MOVIES`, since we are downloading a video clip. Note that the `File` object returned by `getExternalStoragePublicDirectory()` may point to a not-yet-created directory, which is why we call `mkdirs()` on it, to ensure the directory exists.

We then create the `DownloadManager.Request` object, with the following attributes:

1. We are downloading the specific URL we want, courtesy of the `Uri` supplied to the `Request` constructor
2. We are willing to use either mobile data or WiFi for the download (`setAllowedNetworkTypes()`), but we do not want the download to incur roaming charges (`setAllowedOverRoaming()`)
3. We want the file downloaded as `test.mp4` in the downloads area on the external storage (`setDestinationInExternalPublicDir()`)

We also provide a name (`setTitle()`) and description (`setDescription()`), which are used as part of the notification drawer entry for this download. The user will see these when they slide down the drawer while the download is progressing.

The `enqueue()` method returns an ID of this download, which we hold onto for use in querying the download status.

### Keeping Track of Download Status

If the user presses the Query Status button, we want to find out the details of how the download is progressing. To do that, we can call `query()` on the `DownloadManager`. The `query()` method takes a `DownloadManager.Query` object, describing what download(s) you are interested in. In our case, we use the value we got from the `enqueue()` method when the user requested the download:

```
private void queryStatus(View v) {
    Cursor c=
```

## INTENTS, INTENT FILTERS, BROADCASTS, AND BROADCAST RECEIVERS

---

```
mgr.query(new DownloadManager.Query().setFilterById(lastDownload));

if (c == null) {
    Toast.makeText(getActivity(), R.string.download_not_found,
        Toast.LENGTH_LONG).show();
}
else {
    c.moveToFirst();

    Log.d(getClass().getName(),
        "COLUMN_ID: "
        + c.getLong(c.getColumnIndex(DownloadManager.COLUMN_ID)));
    Log.d(getClass().getName(),
        "COLUMN_BYTES_DOWNLOADED_SO_FAR: "
        +
c.getLong(c.getColumnIndex(DownloadManager.COLUMN_BYTES_DOWNLOADED_SO_FAR)));
    Log.d(getClass().getName(),
        "COLUMN_LAST_MODIFIED_TIMESTAMP: "
        +
c.getLong(c.getColumnIndex(DownloadManager.COLUMN_LAST_MODIFIED_TIMESTAMP)));
    Log.d(getClass().getName(),
        "COLUMN_LOCAL_URI: "
        +
c.getString(c.getColumnIndex(DownloadManager.COLUMN_LOCAL_URI)));
    Log.d(getClass().getName(),
        "COLUMN_STATUS: "
        + c.getInt(c.getColumnIndex(DownloadManager.COLUMN_STATUS)));
    Log.d(getClass().getName(),
        "COLUMN_REASON: "
        + c.getInt(c.getColumnIndex(DownloadManager.COLUMN_REASON)));

    Toast.makeText(getActivity(), statusMessage(c), Toast.LENGTH_LONG)
        .show();
}
}
```

The `query()` method returns a `Cursor`, containing a series of columns representing the details about our download. There is a series of constants on the `DownloadManager` class outlining what is possible. In our case, we retrieve (and dump to `LogCat`):

1. The ID of the download (`COLUMN_ID`)
2. The amount of data that has been downloaded to date (`COLUMN_BYTES_DOWNLOADED_SO_FAR`)
3. What the last-modified timestamp is on the download (`COLUMN_LAST_MODIFIED_TIMESTAMP`)
4. Where the file is being saved to locally (`COLUMN_LOCAL_URI`)
5. What the actual status is (`COLUMN_STATUS`)
6. What the reason is for that status (`COLUMN_REASON`)

Note that `COLUMN_LOCAL_URI` may be unavailable, if the user has deleted the downloaded file between when the download completed and the time you try to access the column.

There are a number of possible status codes (e.g., `STATUS_FAILED`, `STATUS_SUCCESSFUL`, `STATUS_RUNNING`). Some, like `STATUS_FAILED`, may have an accompanying reason to provide more details.

### OK, So Why Is This In This Chapter?

To find out about the results of the download, we need to register a `BroadcastReceiver`, to watch for two actions used by `DownloadManager`:

1. `ACTION_DOWNLOAD_COMPLETE`, to let us know when the download is done
2. `ACTION_NOTIFICATION_CLICKED`, to let us know if the user taps on the Notification displayed on the user's device related to our download

So, in `onResume()` of our fragment, we register a single `BroadcastReceiver` for both of those events:

```
@Override
public void onResume() {
    super.onResume();

    IntentFilter f=
        new IntentFilter(DownloadManager.ACTION_DOWNLOAD_COMPLETE);

    f.addAction(DownloadManager.ACTION_NOTIFICATION_CLICKED);

    getActivity().registerReceiver(onEvent, f);
}
```

That `BroadcastReceiver` is unregistered in `onPause()`:

```
@Override
public void onPause() {
    getActivity().unregisterReceiver(onEvent);

    super.onPause();
}
```

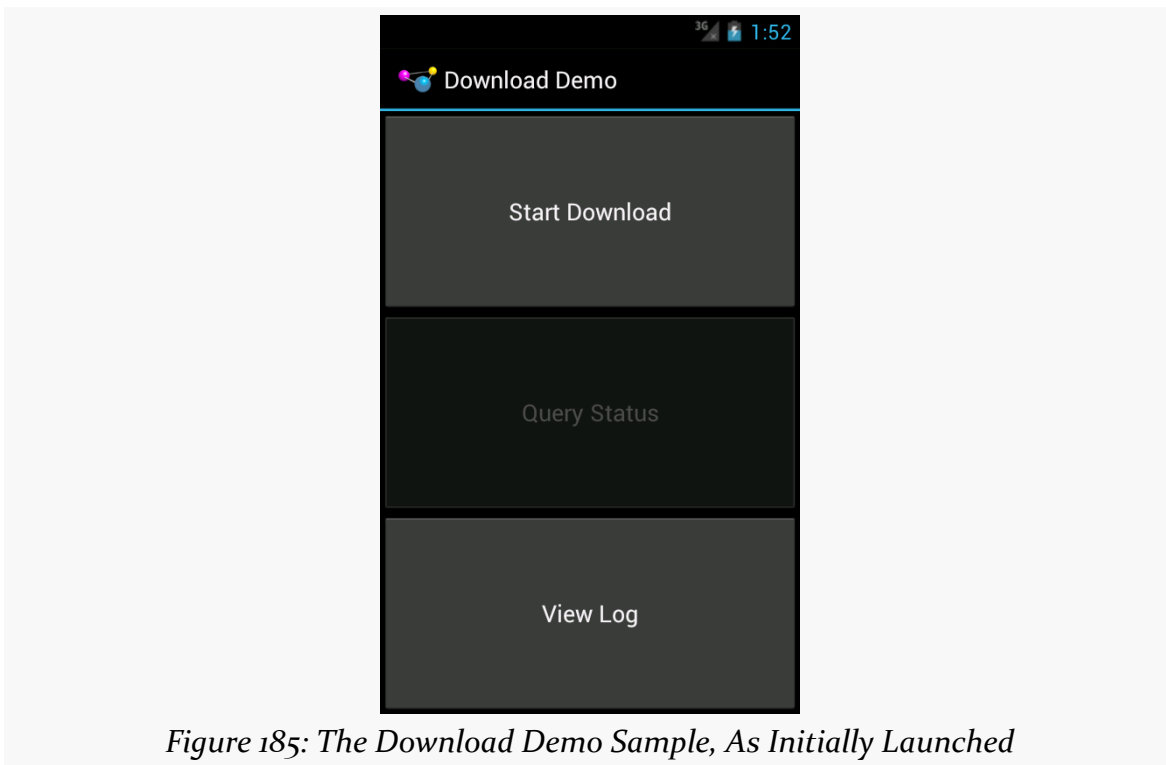
The `BroadcastReceiver` implementation examines the action string of the incoming `Intent` (via a call to `getAction()`) and either displays a `Toast` (for `ACTION_NOTIFICATION_CLICKED`) or enables the start-download `Button`:



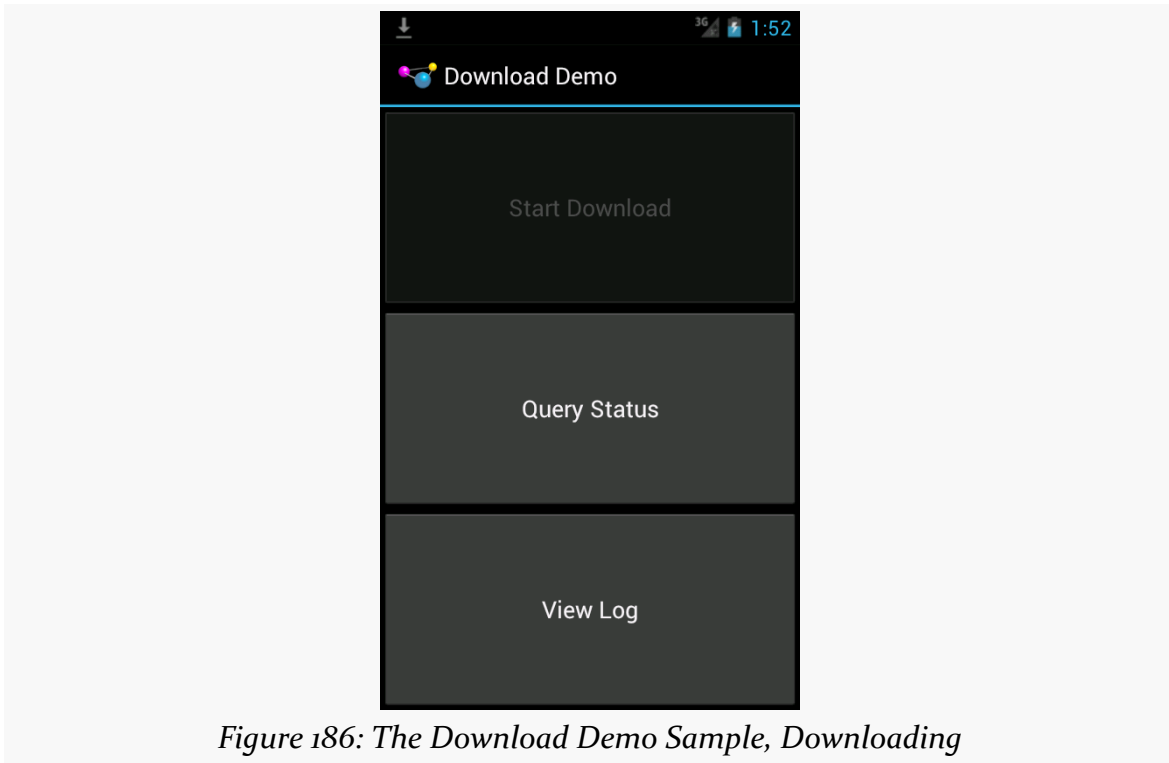
```
private BroadcastReceiver onEvent=new BroadcastReceiver() {
    public void onReceive(Context ctxt, Intent i) {
        if (DownloadManager.ACTION_NOTIFICATION_CLICKED.equals(i.getAction())) {
            Toast.makeText(ctxt, R.string.hi, Toast.LENGTH_LONG).show();
        }
        else {
            start.setEnabled(true);
        }
    }
};
```

### What the User Sees

The user, upon launching the application, sees our three pretty buttons:

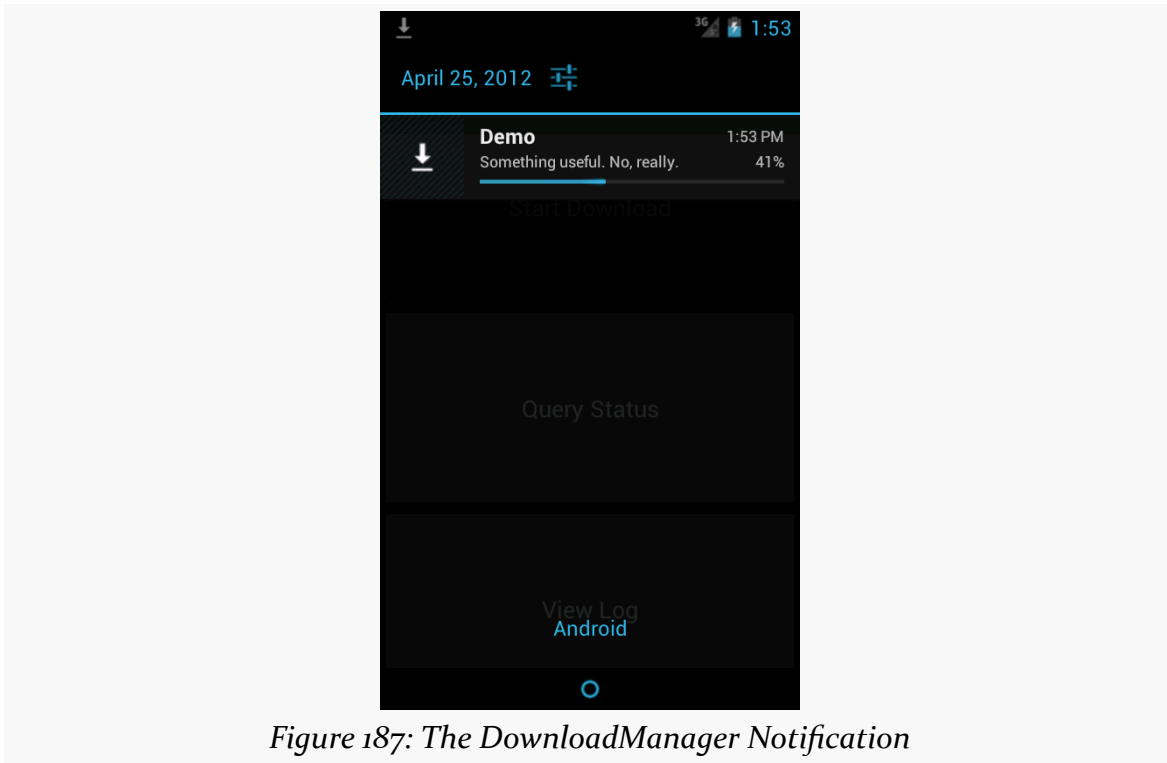


Clicking the first disables the button while the download is going on, and a download icon appears in the status bar (though it is a bit difficult to see, given the poor contrast between Android's icon and Android's status bar):



*Figure 186: The Download Demo Sample, Downloading*

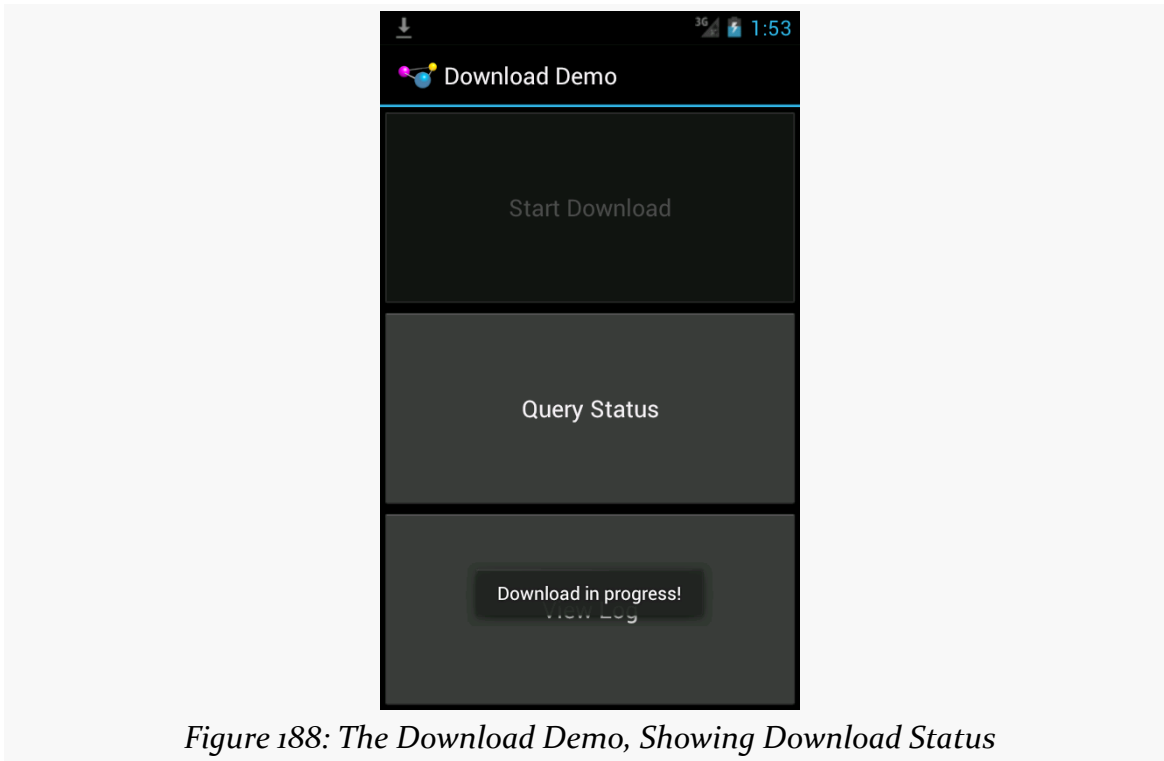
Sliding down the notification drawer shows the user the progress in the form of a ProgressBar widget:



*Figure 187: The DownloadManager Notification*

Tapping on the entry in the notification drawer returns control to our original activity, where they see a Toast, raised by our BroadcastReceiver.

If they tap the middle button during the download, a different Toast will appear indicating that the download is in progress:



Additional details are also dumped to LogCat, visible via DDMS or `adb logcat`:

```
12-10 08:45:01.289: DEBUG/com.commonware.android.download.DownloadDemo(372):  
COLUMN_ID: 12  
12-10 08:45:01.289: DEBUG/com.commonware.android.download.DownloadDemo(372):  
COLUMN_BYTES_DOWNLOADED_SO_FAR: 615400  
12-10 08:45:01.289: DEBUG/com.commonware.android.download.DownloadDemo(372):  
COLUMN_LAST_MODIFIED_TIMESTAMP: 1291988696232  
12-10 08:45:01.289: DEBUG/com.commonware.android.download.DownloadDemo(372):  
COLUMN_LOCAL_URI: file:///mnt/sdcard/Download/test.mp4  
12-10 08:45:01.299: DEBUG/com.commonware.android.download.DownloadDemo(372):  
COLUMN_STATUS: 2  
12-10 08:45:01.299: DEBUG/com.commonware.android.download.DownloadDemo(372):  
COLUMN_REASON: 0
```

Once the download is complete, tapping the middle button will indicate that the download is, indeed, complete, and final information about the download is emitted to LogCat:

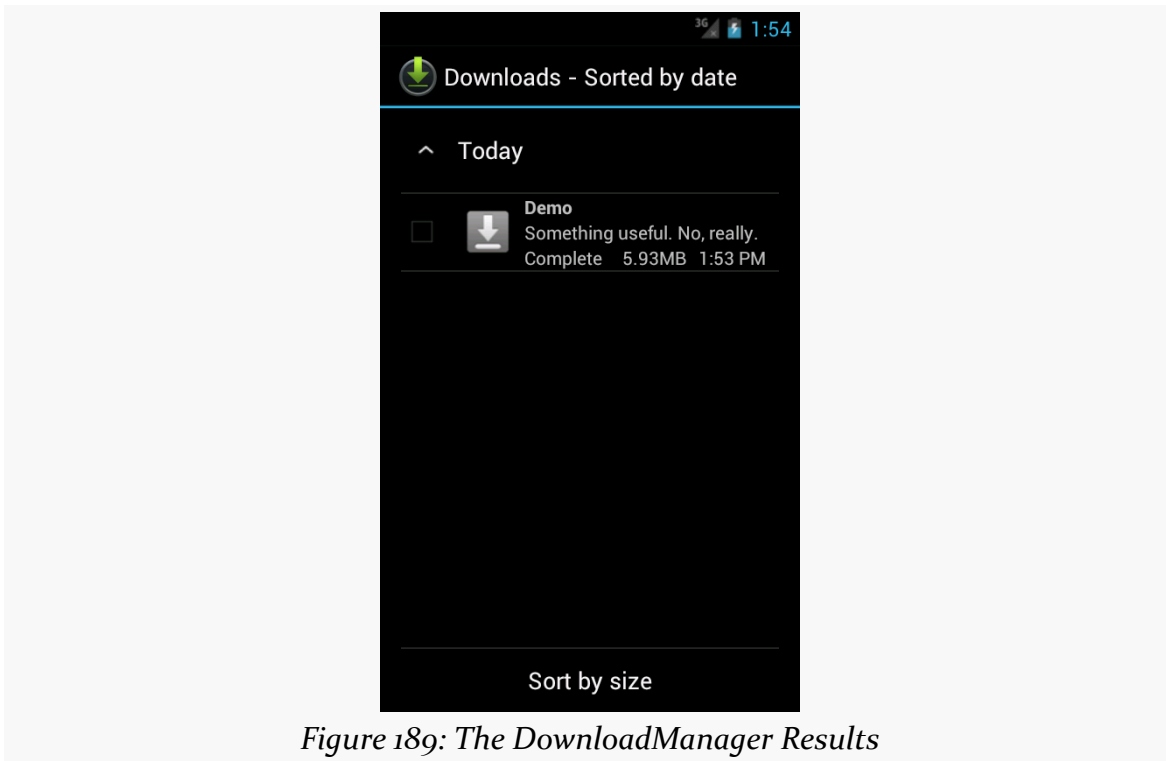
```
12-10 08:49:27.360: DEBUG/com.commonware.android.download.DownloadDemo(372):  
COLUMN_ID: 12  
12-10 08:49:27.360: DEBUG/com.commonware.android.download.DownloadDemo(372):  
COLUMN_BYTES_DOWNLOADED_SO_FAR: 6219229  
12-10 08:49:27.370: DEBUG/com.commonware.android.download.DownloadDemo(372):
```

## INTENTS, INTENT FILTERS, BROADCASTS, AND BROADCAST RECEIVERS

---

```
COLUMN_LAST_MODIFIED_TIMESTAMP: 1291988713409
12-10 08:49:27.370: DEBUG/com.commonware.android.download.DownloadDemo(372):
COLUMN_LOCAL_URI: file:///mnt/sdcard/Download/test.mp4
12-10 08:49:27.370: DEBUG/com.commonware.android.download.DownloadDemo(372):
COLUMN_STATUS: 8
12-10 08:49:27.370: DEBUG/com.commonware.android.download.DownloadDemo(372):
COLUMN_REASON: 0
```

Tapping the bottom button brings up the activity displaying all downloads, including both successes and failures:



*Figure 189: The DownloadManager Results*

And, of course, the file is downloaded. In the emulator, our chosen location maps to `/mnt/sdcard/Downloads/test.mp4`.

### Limitations

`DownloadManager` works with HTTP URLs, but not HTTPS (SSL) URLs, on Android 2.3. Android 3.0 and newer appear to support HTTPS.

If you display the list of all downloads, and your download is among them, it is a really good idea to make sure that some activity (perhaps one of yours) is able to respond to an `ACTION_VIEW` Intent on that download's MIME type. Otherwise, when

the user taps on the entry in the list, they will get a Toast indicating that there is nothing available to view the download. This may confuse users. Alternatively, use `setVisibleInDownloadsUi()` on your request, passing in `false`, to suppress it from this list.

## Keeping It Local

A broadcast Intent, by default and nearly by definition, is broadcast. Anything on the device could have a receiver “tuned in” to listen for such broadcasts. While you can use `setPackage()` on Intent to restrict the distribution, the broadcast still goes through the standard broadcast mechanism, which involves transferring the Intent to an OS process, which then does the actual broadcasting. Hence, a broadcast Intent has some overhead.

Yet, there are times when using broadcasts within an app is handy, but it would be nice to avoid the overhead. To help with this the core Android team added `LocalBroadcastManager` to the Android Support package, to provide an in-process way of doing broadcasts with the standard Intent, `IntentFilter`, and `BroadcastReceiver` classes, yet with less overhead.

## Using LocalBroadcastManager

Let’s see `LocalBroadcastManager` in action via the [Intents/Local](#) sample project.

Here, our `LocalActivity` sends a command to a `NoticeService` from `onCreate()`:

```
@Override
public void onCreate(Bundle savedInstanceState) {
    super.onCreate(savedInstanceState);
    setContentView(R.layout.main);

    notice=(TextView)findViewById(R.id.notice);
    startService(new Intent(this, NoticeService.class));
}
```

The `NoticeService` simply delays five seconds, then sends a local broadcast using `LocalBroadcastManager`:

```
package com.commonware.android.localcast;

import android.app.IntentService;
import android.content.Intent;
import android.os.SystemClock;
import android.support.v4.content.LocalBroadcastManager;
```

## INTENTS, INTENT FILTERS, BROADCASTS, AND BROADCAST RECEIVERS

---

```
public class NoticeService extends IntentService {
    public static final String BROADCAST=
        "com.commonware.android.localcast.NoticeService.BROADCAST";
    private static Intent broadcast=new Intent(BROADCAST);

    public NoticeService() {
        super("NoticeService");
    }

    @Override
    protected void onHandleIntent(Intent intent) {
        SystemClock.sleep(5000);
        LocalBroadcastManager.getInstance(this).sendBroadcast(broadcast);
    }
}
```

Specifically, you get at your process' singleton instance of LocalBroadcastManager by calling `getInstance()` on the LocalBroadcastManager class.

Our LocalActivity registers for this local broadcast in `onResume()`, once again using `getInstance()` on LocalBroadcastManager:

```
@Override
public void onResume() {
    super.onResume();

    IntentFilter filter=new IntentFilter(NoticeService.BROADCAST);

    LocalBroadcastManager.getInstance(this).registerReceiver(onNotice,
        filter);
}
```

LocalActivity unregisters for this broadcast in `onPause()`:

```
@Override
public void onPause() {
    super.onPause();

    LocalBroadcastManager.getInstance(this).unregisterReceiver(onNotice);
}
```

The BroadcastReceiver simply updates a TextView with the current date and time:

```
private BroadcastReceiver onNotice=new BroadcastReceiver() {
    public void onReceive(Context ctxt, Intent i) {
        notice.setText(new Date().toString());
    }
};
```

If you start up this activity, you will see a “(waiting...)” bit of placeholder text for about five seconds, before having that be replaced by the current date and time.

The `BroadcastReceiver`, the `IntentFilter`, and the `Intent` being broadcast are the same as we would use with full broadcasts. It is merely how we are using them — via `LocalBroadcastManager` — that dictates they are local to our process versus the standard device-wide broadcasts.

### Reference, Not Value

When you send a “real” broadcast `Intent`, your `Intent` is converted into a byte array (courtesy of the `Parcelable` interface) and transmitted to other processes. This occurs even if the recipient of the `Intent` is within your own process — that is what makes `LocalBroadcastManager` faster, as it avoids the inter-process communication.

However, since `LocalBroadcastManager` does not need to send your `Intent` between processes, that means it does not turn your `Intent` into a byte array. Instead, it just passes the `Intent` along to any registered `BroadcastReceiver` with a matching `IntentFilter`. In effect, while “real” broadcasts are pass-by-value, local broadcasts are pass-by-reference.

This can have subtle side effects.

For example, there are a few ways that you can put a collection into an `Intent` extra, such as `putStringArrayListExtra()`. This takes an `ArrayList` as a parameter. With a real broadcast, once you send the broadcast, it does not matter what happens to the original `ArrayList` — the rest of the system is working off of a copy. With a local broadcast, though, the `Intent` holds onto the `ArrayList` you supplied via the setter. If you change that `ArrayList` elsewhere (e.g., clear it for reuse), the recipient of the `Intent` will see those changes.

Similarly, if you put a `Parcelable` object in an extra, the `Intent` holds onto the actual object while it is being broadcast locally, whereas a real broadcast would have resulted in a copy. If you change the object while the broadcast is in progress, the recipient of the broadcast will see those changes.

This can be a feature, not a bug, when used properly. But, regardless, it is a non-trivial difference, one that you will need to keep in mind.



### Limitations of Local

While `LocalBroadcastManager` is certainly useful, it has some serious limitations.

The biggest is that it is purely local. While traditional broadcasts can either be internal (via `setPackage()`) or device-wide, `LocalBroadcastManager` only handles the local case. Hence, anything that might involve other processes, such as a `PendingIntent`, will not use `LocalBroadcastManager`. For example, you cannot register a receiver through `LocalBroadcastManager`, then use a `getBroadcast()` `PendingIntent` to try to reach that `BroadcastReceiver`. The `PendingIntent` will use the regular broadcast Intent mechanism, which the local-only receiver will not respond to.

Similarly, since a manifest-registered `BroadcastReceiver` is spawned via the operating system upon receipt of a matching true broadcast, you cannot use such receivers with `LocalBroadcastManager`. Only a `BroadcastReceiver` registered via `registerReceiver()` on the `LocalBroadcastManager` will use the `LocalBroadcastManager`. For example, you cannot implement the Activity-or-Notification pattern that we will see [later in this book](#) via `LocalBroadcastManager`.

Also, `LocalBroadcastManager` does not offer ordered or sticky broadcasts.

# Tutorial #15 - Sharing Your Notes

---

Perhaps you would like to get your notes off of our book reader app and into someplace else, or perhaps you would like to share them with somebody else. Either way, we can do that using an `ACTION_SEND` operation, to allow the user to choose how to “send” the notes, such as sending them by email or uploading them to some third-party note service.

This is a continuation of the work we did in [the previous tutorial](#).

You can find [the results of the previous tutorial](#) and [the results of this tutorial](#) in [the book's GitHub repository](#).

Note that if you are importing the previous code to begin work here, you will also need the [copy of ActionBarSherlock in this book's GitHub repository](#), and to make sure that your imported EmPubLite project references the ActionBarSherlock project as a library.

## Step #1: Adding a Share Action Bar Item

First, we need to allow the user to indicate that they want to “share” the note displayed in the current `NoteFragment`. By putting an action bar item on the activity where the `NoteFragment` is displayed, we do not need to worry about letting the user choose which note to send — we simply send whichever note they happen to be viewing or editing.

Modify `res/menu/notes.xml` to add in the new share toolbar button:

```
<menu xmlns:android="http://schemas.android.com/apk/res/android">
  <item
```

---

## TUTORIAL #15 - SHARING YOUR NOTES

---

```
        android:id="@+id/share"
        android:icon="@android:drawable/ic_menu_share"
        android:showAsAction="ifRoom|withText"
        android:title="@string/share">
    </item>
    <item
        android:id="@+id/delete"
        android:icon="@android:drawable/ic_menu_delete"
        android:showAsAction="ifRoom|withText"
        android:title="@string/delete">
    </item>
</menu>
```

Eclipse users can add this via the structured editor for `res/menu/notes.xml`, following the instructions used for other action bar items.

Note that this menu definition requires a new string resource, named `share`, with a value like `Share`.

### Step #2: Sharing the Note

To actually share the note, we need to start up a new activity using `ACTION_SEND`. A fragment *could* start up this activity, knowing that the activity is one from a third party and therefore never would be composited within one of our activities by way of fragments. However, to keep things clean, let's delegate the work for sending the note to the hosting activity, so all `startActivity()` calls are outside of the fragment.

With that in mind, add the following `sendNotes()` method to `NoteActivity`:

```
void sendNotes(String prose) {
    Intent i=new Intent(Intent.ACTION_SEND);

    i.setType("text/plain");
    i.putExtra(Intent.EXTRA_TEXT, prose);

    startActivity(Intent.createChooser(i,
                                     getString(R.string.share_title)));
}
```

We create an `ACTION_SEND` Intent, fill in our note into `EXTRA_TEXT`, set the MIME type to be `text/plain` (since it is unlikely that our user will be entering HTML source code or something as the note), then call `startActivity()` on the Intent returned by `createChooser()`.

Note that this method requires a new string resource, named `share_title`, with a value like `Share Notes`.

### Step #3: Tying Them Together

To tie these pieces together, we need to implement logic to handle our new action bar item and call `sendNotes()`. To that end, modify the `onOptionsItemSelected()` implementation on `NoteFragment` to include the this logic, via an `else if` block:

```
@Override
public boolean onOptionsItemSelected(MenuItem item) {
    if (item.getItemId() == R.id.delete) {
        int position=getArguments().getInt(KEY_POSITION, -1);

        isDeleted=true;
        DatabaseHelper.getInstance(getActivity())
            .deleteNoteAsync(position);

        ((NoteActivity)getActivity()).closeNotes();

        return(true);
    }
    else if (item.getItemId() == R.id.share) {
        ((NoteActivity)getActivity()).sendNotes(editor.getText()
            .toString());

        return(true);
    }

    return(super.onOptionsItemSelected(item));
}
```

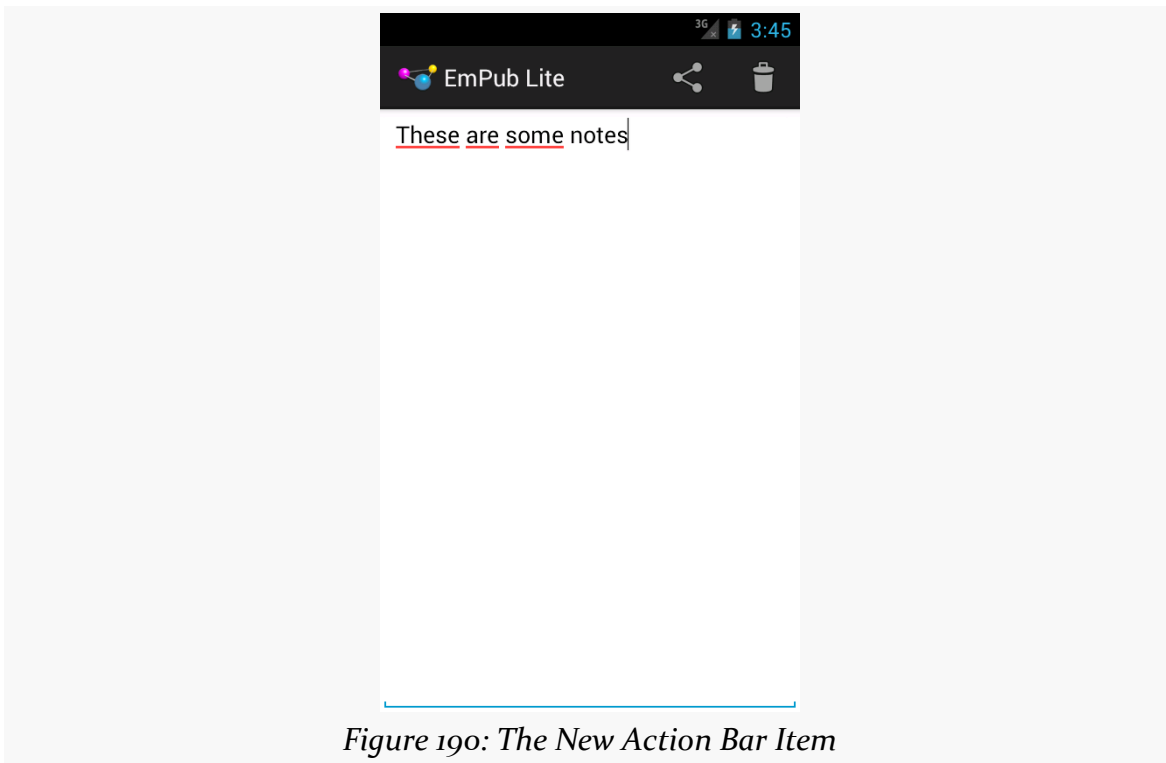
All we do is call `sendNotes()` on the hosting activity, using the current contents of the `EditText` as the notes, so any not-yet-persisted changes are still shared.

### Step #4: Testing the Result

If you run this on a device, navigate to a note, you will see the new action bar item:

## TUTORIAL #15 - SHARING YOUR NOTES

---



*Figure 190: The New Action Bar Item*

If you tap on that, you should get a chooser of various things that know how to send plain text.

Unfortunately, your emulator may have nothing that can handle this Intent. If that is the case, you will crash with an `ActivityNotFoundException`. To get past this, if you enter `http://goo.gl/w113e` in your emulator's browser, that should allow you to download and install a copy of the APK from the [Intents/FauxSender](#) sample project that we covered [earlier in this book](#). When the download is complete (which should be very quick), open up the notification drawer and tap on the “download complete” notification. This should begin the installation process. Depending on your Android version, you may also need to “allow installation of non-Market apps” — after fixing this, you can use the Downloads app on the emulator to try installing the APK again. Once FauxSender is installed, it will respond to your attempts to share a note.

## In Our Next Episode...

... we will allow the user to [update the book's contents](#) over the Internet.

# Services and the Command Pattern

---

As noted previously, Android services are for long-running processes that may need to keep running even when decoupled from any activity. Examples include playing music even if the “player” activity gets garbage-collected, polling the Internet for RSS/Atom feed updates, and maintaining an online chat connection even if the chat client loses focus due to an incoming phone call.

Services are created when manually started (via an API call) or when some activity tries connecting to the service via inter-process communication (IPC). Services will live until specifically shut down or until Android is desperate for RAM and destroys them prematurely. Running for a long time has its costs, though, so services need to be careful not to use too much CPU or keep radios active too much of the time, lest the service cause the device’s battery to get used up too quickly.

This chapter outlines the basic theory behind creating and consuming services, including a look at the “command pattern” for services.

## Why Services?

Services are a “Swiss Army knife” for a wide range of functions that do not require direct access to an activity’s user interface, such as:

1. Performing operations that need to continue even if the user leaves the application’s activities, like a long download (as seen with the Android Market) or playing music (as seen with Android music apps)
2. Performing operations that need to exist regardless of activities coming and going, such as maintaining a chat connection in support of a chat application

3. Providing a local API to remote APIs, such as might be provided by a Web service
4. Performing periodic work without user intervention, akin to cron jobs or Windows scheduled tasks

Even things like home screen app widgets often involve a service to assist with long-running work.

Many applications will not need any services. Very few applications will need more than one. However, the service is a powerful tool for an Android developer's toolbox and is a subject with which any qualified Android developer should be familiar.

## Setting Up a Service

Creating a service implementation shares many characteristics with building an activity. You inherit from an Android-supplied base class, override some lifecycle methods, and hook the service into the system via the manifest.

### The Service Class

Just as an activity in your application extends either `Activity` or an Android-supplied `Activity` subclass, a service in your application extends either `Service` or an Android-supplied `Service` subclass. The most common `Service` subclass is `IntentService`, used primarily for the command pattern, described [later in this chapter](#). That being said, many services simply extend `Service`.

### Lifecycle Methods

Just as activities have `onCreate()`, `onResume()`, `onPause()` and kin, `Service` implementations have their own lifecycle methods, such as:

- `onCreate()`, which, as with activities, is called when the service process is created, by any means
- `onStartCommand()`, which is called each time the service is sent a command via `startService()`
- `onBind()`, which is called whenever a client binds to the service via `bindService()`
- `onDestroy()` which is called as the service is being shut down

As with activities, services initialize whatever they need in `onCreate()` and clean up those items in `onDestroy()`. And, as with activities, the `onDestroy()` method of a service might not be called, if Android terminates the entire application process, such as for emergency RAM reclamation.

The `onStartCommand()` and `onBind()` lifecycle methods will be implemented based on your choice of communicating to the client, as will be explained [later in this chapter](#).

### Manifest Entry

Finally, you need to add the service to your `AndroidManifest.xml` file, for it to be recognized as an available service for use. That is simply a matter of adding a `<service>` element as a child of the application element, providing `android:name` to reference your service class.

Since the service class is in the same Java namespace as everything else in this application, we can use the shorthand ("`WeatherService`" or "`.WeatherService`") to reference our class.

For example, here is a manifest showing the `<service>` element:

```
<?xml version="1.0" encoding="utf-8"?>
<manifest xmlns:android="http://schemas.android.com/apk/res/android"
    package="com.commonware.android.fakeplayer"
    android:versionCode="1"
    android:versionName="1.0">

    <supports-screens
        android:anyDensity="true"
        android:largeScreens="true"
        android:normalScreens="true"
        android:smallScreens="true"/>

    <uses-sdk
        android:minSdkVersion="7"
        android:targetSdkVersion="14"/>

    <application
        android:icon="@drawable/ic_launcher"
        android:label="@string/app_name"
        android:theme="@style/Theme.Sherlock">
        <activity
            android:name="FakePlayer"
            android:label="@string/app_name">
            <intent-filter>
                <action android:name="android.intent.action.MAIN"/>
            </intent-filter>
        </activity>
    </application>
</manifest>
```



```
        <category android:name="android.intent.category.LAUNCHER"/>
    </intent-filter>
</activity>

    <service android:name="PlayerService"/>
</application>

</manifest>
```

## Communicating To Services

Clients of services — frequently activities, though not necessarily — have two main ways to send requests or information to a service. One approach is to send a command, which creates no lasting connection to the service. The other approach is to bind to the service, establishing a bi-directional communications channel that lasts as long as the client needs it.

### Sending Commands with `startService()`

The simplest way to work with a service is to call `startService()`. The `startService()` method takes an `Intent` parameter, much like `startActivity()` does. In fact, the `Intent` supplied to `startService()` has the same two-part role as it does with `startActivity()`:

1. Identify the service to communicate with
2. Supply parameters, in the form of `Intent` extras, to tell the service what it is supposed to do

For a local service — the focus of this book — the simplest form of `Intent` is one that identifies the class that implements the `Intent` (e.g., `new Intent(this, MyService.class);`).

The call to `startService()` is asynchronous, so the client will not block. The service will be created if it is not already running, and it will receive the `Intent` via a call to the `onStartCommand()` lifecycle method. The service can do whatever it needs to in `onStartCommand()`, but since `onStartCommand()` is called on the main application thread, it should do its work very quickly. Anything that might take a while should be delegated to a background thread.

The `onStartCommand()` method can return one of several values, mostly to indicate to Android what should happen if the service's process should be killed while it is running. The most likely return values are:

1. `START_STICKY`, meaning that the service should be moved back into the started state (as if `onStartCommand()` had been called), but do not re-deliver the Intent to `onStartCommand()`
2. `START_REDELIVER_INTENT`, meaning that the service should be restarted via a call to `onStartCommand()`, supplying the same Intent as was delivered this time
3. `START_NOT_STICKY`, meaning that the service should remain stopped until explicitly started by application code

By default, calling `startService()` not only sends the command, but tells Android to keep the service running until something tells it to stop. One way to stop a service is to call `stopService()`, supplying the same Intent used with `startService()`, or at least one that is equivalent (e.g., identifies the same class). At that point, the service will stop and will be destroyed. Note that `stopService()` does not employ any sort of reference counting, so three calls to `startService()` will result in a single service running, which will be stopped by a call to `stopService()`.

Another possibility for stopping a service is to have the service call `stopSelf()` on itself. You might do this if you use `startService()` to have a service begin running and doing some work on a background thread, then having the service stop itself when that background work is completed.

### Binding to Services

Another approach to communicating with a service is to use the binding pattern. Here, instead of packaging commands to be sent via an Intent, you can obtain an actual API from the service, with whatever data types, return values, and so on that you wish. You then invoke that API no different than you would on some local object.

The benefit is the richer API. The cost is that binding is more complex to set up and more complex to maintain, particularly across configuration changes.

We will discuss the binding pattern later in this book.

## Scenario: The Music Player

Most audio player applications in Android — for music, audiobooks, or whatever — do not require the user to remain in the player application itself. Rather, the user can go on and do other things with their device, with the audio playing in the background.

The sample project reviewed in this section is [Service/FakePlayer](#).

### The Design

We will use `startService()`, since we want the service to run even when the activity starting it has been destroyed. However, we will use a regular `Service`, rather than an `IntentService`. An `IntentService` is designed to do work and stop itself, whereas in this case, we want the user to be able to stop the music playback when the user wants to.

Since music playback is outside the scope of this chapter, the service will simply stub out those particular operations.

### The Service Implementation

Here is the implementation of this `Service`, named `PlayerService`:

```
package com.commonware.android.fakeplayer;

import android.app.Service;
import android.content.Intent;
import android.os.IBinder;
import android.util.Log;

public class PlayerService extends Service {
    public static final String EXTRA_PLAYLIST="EXTRA_PLAYLIST";
    public static final String EXTRA_SHUFFLE="EXTRA_SHUFFLE";
    private boolean isPlaying=false;

    @Override
    public int onStartCommand(Intent intent, int flags, int startId) {
        String playlist=intent.getStringExtra(EXTRA_PLAYLIST);
        boolean useShuffle=intent.getBooleanExtra(EXTRA_SHUFFLE, false);

        play(playlist, useShuffle);

        return(START_NOT_STICKY);
    }
}
```

```
@Override
public void onDestroy() {
    stop();
}

@Override
public IBinder onBind(Intent intent) {
    return(null);
}

private void play(String playlist, boolean useShuffle) {
    if (!isPlaying) {
        Log.w(getClass().getName(), "Got to play()!");
        isPlaying=true;
    }
}

private void stop() {
    if (isPlaying) {
        Log.w(getClass().getName(), "Got to stop()!");
        isPlaying=false;
    }
}
}
```

In this case, we really do not need anything for `onCreate()`, so that lifecycle method is skipped. On the other hand, we have to implement `onBind()`, because that is an abstract method on `Service`.

When the client calls `startService()`, `onStartCommand()` is called in `PlayerService`. Here, we get the `Intent` and pick out some extras to tell us what to play back (`EXTRA_PLAYLIST`) and other configuration details (e.g., `EXTRA_SHUFFLE`). `onStartCommand()` calls `play()`, which simply flags that we are playing and logs a message to `LogCat` — a real music player would use `MediaPlayer` to start playing the first song in the playlist. `onStartCommand()` returns `START_NOT_STICKY`, indicating that if Android has to kill off this service (e.g., low memory), it should not restart it once conditions improve.

`onDestroy()` stops the music from playing — theoretically, anyway — by calling a `stop()` method. Once again, this just logs a message to `LogCat`, plus updates our internal are-we-playing flag.

In [the upcoming chapter on notifications](#), we will revisit this sample and discuss the use of `startForeground()` to make it easier for the user to get back to the music player, plus let Android know that the service is delivering part of the foreground experience and therefore should not be shut down.

## Using the Service

The PlayerFragment demonstrating the use of PlayerService has a very elaborate UI, consisting of two large buttons:

```
<?xml version="1.0" encoding="utf-8"?>
<LinearLayout xmlns:android="http://schemas.android.com/apk/res/android"
    android:layout_width="fill_parent"
    android:layout_height="fill_parent"
    android:orientation="vertical">

    <Button
        android:id="@+id/start"
        android:layout_width="fill_parent"
        android:layout_height="fill_parent"
        android:layout_weight="1"
        android:text="@string/start_the_player"/>

    <Button
        android:id="@+id/stop"
        android:layout_width="fill_parent"
        android:layout_height="fill_parent"
        android:layout_weight="1"
        android:text="@string/stop_the_player"/>

</LinearLayout>
```

The fragment itself is not much more complex:

```
package com.commonware.android.fakeplayer;

import android.content.Intent;
import android.os.Bundle;
import android.view.LayoutInflater;
import android.view.View;
import android.view.ViewGroup;
import com.actionbarsherlock.app.SherlockFragment;

public class PlayerFragment extends SherlockFragment implements
    View.OnClickListener {
    @Override
    public View onCreateView(LayoutInflater inflater, ViewGroup parent,
        Bundle savedInstanceState) {
        View result=inflater.inflate(R.layout.main, parent, false);

        result.findViewById(R.id.start).setOnClickListener(this);
        result.findViewById(R.id.stop).setOnClickListener(this);

        return(result);
    }

    @Override
```

```
public void onClick(View v) {
    Intent i=new Intent(getActivity(), PlayerService.class);

    if (v.getId()==R.id.start) {
        i.putExtra(PlayerService.EXTRA_PLAYLIST, "main");
        i.putExtra(PlayerService.EXTRA_SHUFFLE, true);

        getActivity().startService(i);
    }
    else {
        getActivity().stopService(i);
    }
}
}
```

The `onCreate()` method merely loads the UI. The `onClick()` method constructs an `Intent` with fake values for `EXTRA_PLAYLIST` and `EXTRA_SHUFFLE`, then calls `startService()`. After you press the top button, you will see the corresponding message in LogCat. Similarly, `stopPlayer()` calls `stopService()`, triggering the second LogCat message. Notably, you do not need to keep the activity running in between those button clicks — you can exit the activity via `BACK` and come back later to stop the service.

## Communicating *From* Services

Sending commands to a service, by default, is a one-way street. Frequently, though, we need to get results from our service back to our activity. There are a few approaches for how to accomplish this.

### Broadcast Intents

One approach, first mentioned in the chapter on [Intent filters](#), is to have the service send a broadcast `Intent` that can be picked up by the activity... assuming the activity is still around and is not paused. The service can call `sendBroadcast()`, supplying an `Intent` that identifies the broadcast, designed to be picked up by a `BroadcastReceiver`. This could be a component-specific broadcast (e.g., `new Intent(this, MyReceiver.class)`), if the `BroadcastReceiver` is registered in the manifest. Or, it can be based on some action string, perhaps one even documented and designed for third-party applications to listen for.

The activity, in turn, can register a `BroadcastReceiver` via `registerReceiver()`, though this approach will only work for `Intent` objects specifying some action, not ones identifying a particular component. But, when the activity's

BroadcastReceiver receives the broadcast, it can do what it wants to inform the user or otherwise update itself.

### Pending Results

Your activity can call `createPendingResult()`. This returns a `PendingIntent` – an object that represents an `Intent` and the corresponding action to be performed upon that `Intent` (e.g., use it to start an activity). In this case, the `PendingIntent` will cause a result to be delivered to your activity's implementation of `onActivityResult()`, just as if another activity had been called with `startActivityForResult()` and, in turn, called `setResult()` to send back a result.

Since a `PendingIntent` is `Parcelable`, and can therefore be put into an `Intent` extra, your activity can pass this `PendingIntent` to the service. The service, in turn, can call one of several flavors of the `send()` method on the `PendingIntent`, to notify the activity (via `onActivityResult()`) of an event, possibly even supplying data (in the form of an `Intent`) representing that event.

We will be seeing `PendingIntent` used many places later in this book.

### Messenger

Yet another possibility is to use a `Messenger` object. A `Messenger` sends messages to an activity's `Handler`. Within a single activity, a `Handler` can be used to send messages to itself, as was mentioned briefly in the [chapter on threads](#). However, between components — such as between an activity and a service — you will need a `Messenger` to serve as the bridge.

As with a `PendingIntent`, a `Messenger` is `Parcelable`, and so can be put into an `Intent` extra. The activity calling `startService()` or `bindService()` would attach a `Messenger` as an extra on the `Intent`. The service would obtain that `Messenger` from the `Intent`. When it is time to alert the activity of some event, the service would:

1. Call `Message.obtain()` to get an empty `Message` object
2. Populate that `Message` object as needed, with whatever data the service wishes to pass to the activity
3. Call `send()` on the `Messenger`, supplying the `Message` as a parameter

The `Handler` will then receive the message via `handleMessage()`, on the main application thread, and so can update the UI or whatever is necessary.

## Notifications

Another approach is for the service to let the user know directly about the work that was completed. To do that, a service can raise a `Notification` — putting an icon in the status bar and optionally shaking or beeping or something. This technique is covered in [an upcoming chapter](#).

## Scenario: The Downloader

If you elect to download something from the Play Store, you are welcome to back out of the Market application entirely. This does not cancel the download – the download and installation run to completion, despite no Market activity being on-screen.

You may have similar circumstances in your application, from downloading a purchased e-book to downloading a map for a game to downloading a file from some sort of “drop box” file-sharing service.

Android 2.3 introduced the `DownloadManager` (covered in [a previous chapter](#)), which would handle this for you. However, you might need that sort of capability on older versions of Android, at least through late 2012, as Android 2.2 fades into the distance.

The sample project reviewed in this section is [Service/Downloader](#).

## The Design

This sort of situation is a perfect use for the command pattern and an `IntentService`. The `IntentService` has a background thread, so downloads can take as long as needed. An `IntentService` will automatically shut down when the work is done, so the service will not linger and you do not need to worry about shutting it down yourself. Your activity can simply send a command via `startService()` to the `IntentService` to tell it to go do the work.

Admittedly, things get a bit trickier when you want to have the activity find out when the download is complete. This example will show the use of a `BroadcastReceiver` for this.



### Using the Service

The DownloadFragment demonstrating the use of Downloader has a trivial UI, consisting of one large button:

```
<?xml version="1.0" encoding="utf-8"?>
<Button xmlns:android="http://schemas.android.com/apk/res/android"
    android:id="@+id/button"
    android:layout_width="fill_parent"
    android:layout_height="fill_parent"
    android:text="@string/do_the_download"
/>
```

That UI is initialized in onCreateView(), as usual:

```
@Override
public View onCreateView(LayoutInflater inflater, ViewGroup parent,
    Bundle savedInstanceState) {
    View result=inflater.inflate(R.layout.main, parent, false);

    b=(Button)result.findViewById(R.id.button);
    b.setOnClickListener(this);

    return(result);
}
```

When the user clicks the button, onClick() is called to disable the button (to prevent accidental duplicate downloads) and call startService() to send over a command:

```
@Override
public void onClick(View v) {
    b.setEnabled(false);

    Intent i=new Intent(getActivity(), Downloader.class);

    i.setData(Uri.parse("http://commonsware.com/Android/excerpt.pdf"));

    getActivity().startService(i);
}
```

Here, the Intent we pass over has the URL of the file to download (in this case, a URL pointing to a PDF).

### The Service Implementation

Here is the implementation of this IntentService, named Downloader:

## SERVICES AND THE COMMAND PATTERN

---

```
package com.commonware.android.downloader;

import android.app.IntentService;
import android.content.Intent;
import android.os.Environment;
import android.util.Log;
import java.io.BufferedOutputStream;
import java.io.File;
import java.io.FileOutputStream;
import java.io.IOException;
import java.io.InputStream;
import java.net.HttpURLConnection;
import java.net.URL;

public class Downloader extends IntentService {
    public static final String ACTION_COMPLETE=
        "com.commonware.android.downloader.action.COMPLETE";

    public Downloader() {
        super("Downloader");
    }

    @Override
    public void onHandleIntent(Intent i) {
        try {
            File root=
Environment.getExternalStoragePublicDirectory(Environment.DIRECTORY_DOWNLOADS);

            root.mkdirs();

            File output=new File(root, i.getData().getLastPathSegment());

            if (output.exists()) {
                output.delete();
            }

            URL url=new URL(i.getData().toString());
            HttpURLConnection c=(HttpURLConnection)url.openConnection();

            c.setRequestMethod("GET");
            c.setReadTimeout(15000);
            c.connect();

            FileOutputStream fos=new FileOutputStream(output.getPath());
            BufferedOutputStream out=new BufferedOutputStream(fos);

            try {
                InputStream in=c.getInputStream();
                byte[] buffer=new byte[8192];
                int len=0;

                while ((len=in.read(buffer)) > 0) {
                    out.write(buffer, 0, len);
                }
            }
        }
    }
}
```

```
    }

    out.flush();
}
finally {
    fos.getFD().sync();
    out.close();
}

sendBroadcast(new Intent(ACTION_COMPLETE));
}
catch (IOException e2) {
    Log.e(getClass().getName(), "Exception in download", e2);
}
}
}
```

Our business logic is in `onHandleIntent()`, which is called on an Android-supplied background thread, so we can take whatever time we need. Also, when `onHandleIntent()` ends, the `IntentService` will stop itself automatically... assuming no other requests for downloads occurred while `onHandleIntent()` was running. In that case, `onHandleIntent()` is called again for the next download, and so on.

In `onHandleIntent()`, we first set up a `File` object pointing to where we want to download the file. We use `getExternalStorageDirectory()` to find the public folder for downloads. Since this directory may not exist, we need to create it using `mkdirs()`. We then use the `getLastPathSegment()` convenience method on `Uri`, which returns to us the filename portion of a path-style `Uri`. The result is that our output `File` object points to a file, named the same as the file we are downloading, in a public folder.

We then go through a typical `URLConnection` process to connect to the URL supplied via the `Uri` in the `Intent`, streaming the results from the connection (8KB at a time) out to our designated file. Then, we follow the requested recipe to ensure our file is saved:

- `flush()` the stream
- `sync()` the `FileDescriptor` (from `getFD()`)
- `close()` the stream

Finally, it would be nice to let somebody know that the download has completed. So, we send a broadcast `Intent`, with our own custom action (`ACTION_COMPLETE`).

## Receiving the Broadcast

Our DownloadFragment is set up to listen for that broadcast Intent, by registering a BroadcastReceiver in onResume() and unregistering it in onPause():

```
@Override
public void onResume() {
    super.onResume();

    IntentFilter f=
        new IntentFilter(Downloader.ACTION_COMPLETE);

    getActivity().registerReceiver(onEvent, f);
}

@Override
public void onPause() {
    getActivity().unregisterReceiver(onEvent);

    super.onPause();
}
```

The BroadcastReceiver itself re-enables our button, plus displays a Toast indicating that the download is complete:

```
private BroadcastReceiver onEvent=new BroadcastReceiver() {
    public void onReceive(Context ctxt, Intent i) {
        b.setEnabled(true);

        Toast.makeText(getActivity(), R.string.download_complete,
            Toast.LENGTH_LONG).show();
    }
};
```

Note that if the user leaves the activity (e.g., BACK, HOME), the broadcast will not be received by the activity. There are other ways of addressing this, particularly combining an ordered broadcast with a Notification, which we will examine [later in this book](#).



# Tutorial #16 - Updating the Book

---

The app is designed to ship a copy of the book's chapters as assets, so a user can just download one thing and get everything they need: book and reader.

However, sometimes books get updated. This is a bit less likely with the material being used in this tutorial, as it is rather unlikely that H. G. Wells will rise from the grave to amend *The War of the Worlds*. However, other books, such as Android developer guides written by balding guys, might be updated more frequently.

Most likely, the way you would get those updates is by updating the entire app, so you get improvements to the reader as well. However, another approach would be to be able to download an update to the book as a separate ZIP file. The reader would use the contents of that ZIP file if one has been downloaded, otherwise it will “fall back” to the copy in assets. That is the approach that we will take in this tutorial, to experiment a bit with Internet access and services.

This is a rather lengthy tutorial.

This is a continuation of the work we did in [the previous tutorial](#).

You can find [the results of the previous tutorial](#) and [the results of this tutorial](#) in [the book's GitHub repository](#).

Note that if you are importing the previous code to begin work here, you will also need the [copy of ActionBarSherlock in this book's GitHub repository](#), and to make sure that your imported EmPubLite project references the ActionBarSherlock project as a library.

## Step #1: Adding a Stub DownloadCheckService

There are a few pieces to our download-the-book-update puzzle:

- We need to determine if there is an update available and, if so, where we can find the ZIP file that is the update
- We need to download the update's ZIP file, which could be a fairly large file
- We need to unpack that ZIP file into internal or external storage, so that it is more easily used by the rest of our code and performs more quickly than would dynamically reading the contents out of the ZIP on the fly
- All of that needs to happen in the background from a threading standpoint
- Ideally, all of that could happen either in the foreground or the background from a UI standpoint (i.e., user manually requests an update check, or an update check is performed automatically on a scheduled basis)

To address the first puzzle piece — determining if there is an update available — we can use an `IntentService`. That makes it easy for us to do the work not only in the background from a threading standpoint, but also be able to use it either from the UI or from some sort of background-work scheduler. So, let's add a `DownloadCheckService` to our project.

If you wish to make this change using Eclipse's wizards and tools, follow the instructions in the "Eclipse" section below. Otherwise, follow the instructions in the "Outside of Eclipse" section (appears after the "Eclipse" section).

### Eclipse

Right click over the `com.commonware.empublite` package in the `src/` folder of your project, and choose `New > Class` from the context menu. Fill in `DownloadCheckService` in the "Name" field. Click the "Browse..." button next to the "Superclass" field and find `IntentService` to set as the superclass. Then, click "Finish" on the new-class dialog to create the `DownloadCheckService` class.

Then, with `DownloadCheckService` open in the editor, paste in the following class definition:

```
package com.commonware.empublite;

import android.app.IntentService;
import android.content.Intent;

public class DownloadCheckService extends IntentService {
```

```
public DownloadCheckService() {
    super("DownloadCheckService");
}

@Override
protected void onHandleIntent(Intent intent) {
}
}
```

You will also need to add a new *service* node to the list of nodes in the Application sub-tab of `AndroidManifest.xml`, pointing to `DownloadCheckService`, following the same approach that we used for activities in this application — just be sure to define a service instead of an activity.

### Outside of Eclipse

Create a `src/com/commonsware/empublite/DownloadCheckService.java` source file, with the content shown above. Also add the following `<service>` element as a child of the `<application>` element in your `AndroidManifest.xml` file:

```
<service android:name="DownloadCheckService">
</service>
```

## Step #2: Tying the Service Into the Action Bar

To allow the user to manually request that we update the book (if an update is available), we should add a new action bar item to `EmPubLiteActivity`, to the `res/menu/options.xml` file:

```
<item
    android:id="@+id/update"
    android:icon="@android:drawable/ic_menu_save"
    android:showAsAction="ifRoom|withText"
    android:title="@string/download_update">
</item>
```

Eclipse users can add this via the structured editor for `res/menu/options.xml`, following the instructions used for other action bar items.

Note that this menu definition requires a new string resource, named `download_update`, with a value like `Download Update`.

That allows us to add a new case to the switch statement in `onOptionsItemSelected()` in `EmPubLiteActivity`:



```
case R.id.update:
    startService(new Intent(this, DownloadCheckService.class));
    return(true);
```

All we do here is send a command to our `DownloadCheckService` to see if a download is available.

### Step #3: Adding a Stub `DownloadCompleteReceiver`

Ideally, our actual downloading will be done by `DownloadManager`, as it handles all of the idiosyncrasies with network type failover and so on. The way we find out that a download from `DownloadManager` is complete is via a broadcast `Intent`. So, we need to set up a receiver for that `Intent`. And, since we do not know if our process will be around when the download is complete, we should set up that `BroadcastReceiver` in the manifest.

If you wish to make this change using Eclipse's wizards and tools, follow the instructions in the "Eclipse" section below. Otherwise, follow the instructions in the "Outside of Eclipse" section (appears after the "Eclipse" section).

#### Eclipse

Right click over the `com.commonware.empublite` package in the `src/` folder of your project, and choose `New > Class` from the context menu. Fill in `DownloadCompleteReceiver` in the "Name" field. Click the "Browse..." button next to the "Superclass" field and find `BroadcastReceiver` to set as the superclass. Then, click "Finish" on the new-class dialog to create the `DownloadCompleteReceiver` class.

You will also need to add a new *receiver* node to the list of nodes in the `Application` sub-tab of `AndroidManifest.xml`, pointing to `DownloadCompleteReceiver`, following the same approach that we used for activities in this application — just be sure to define a receiver instead of an activity.

However, we also must add an `<intent-filter>` to the `<receiver>` element, identifying the broadcast which we wish to monitor. To do that:

- Click on the Receiver element associated with `DownloadCompleteReceiver` in the list of "Application Nodes"

- Click the “Add...” button next to the list of “Application Nodes” and choose “Intent Filter” from the list
- With the “Intent Filter” highlighted in the “Application Nodes” tree, click “Add...” again, this time choosing “Action” from the list
- In the details area on the right, *type in* `android.intent.action.DOWNLOAD_COMPLETE`, as this one does not appear in the drop-down in the current version of the ADT plugin for Eclipse

### Outside of Eclipse

Create a `src/com/commonsware/empublite/DownloadCompleteReceiver.java` source file, with the following code:

```
package com.commonsware.empublite;

import android.content.BroadcastReceiver;
import android.content.Context;
import android.content.Intent;

public class DownloadCompleteReceiver extends BroadcastReceiver {
    @Override
    public void onReceive(Context ctxt, Intent i) {
    }
}
```

Also add the following `<receiver>` element as a child of the `<application>` element in your `AndroidManifest.xml` file:

```
<receiver android:name="DownloadCompleteReceiver">
  <intent-filter>
    <action android:name="android.intent.action.DOWNLOAD_COMPLETE"/>
  </intent-filter>
</receiver>
</application>
```

### Step #4: Completing the DownloadCheckService

Now that we have some of our other dependencies in place, like `DownloadCompleteReceiver`, we can add in the business logic for `DownloadCheckService`.

First, add an `UPDATE_URL` static data member to `DownloadCheckService`, containing the URL we will poll to see if there is an update available:

## TUTORIAL #16 - UPDATING THE BOOK

---

```
private static final String UPDATE_URL=  
    "http://misc.commonsware.com/empublite-update.json";
```

Next, replace the stub `onHandleIntent()` method we have now in `DownloadCheckService` with the following:

```
@Override  
protected void onHandleIntent(Intent intent) {  
    BufferedReader reader=null;  
  
    try {  
        URL url=new URL(UPDATE_URL);  
        HttpURLConnection c=(HttpURLConnection)url.openConnection();  
  
        c.setRequestMethod("GET");  
        c.setReadTimeout(15000);  
        c.connect();  
  
        reader=  
            new BufferedReader(new InputStreamReader(c.getInputStream()));  
  
        StringBuilder buf=new StringBuilder();  
        String line=null;  
  
        while ((line=reader.readLine()) != null) {  
            buf.append(line + "\n");  
        }  
  
        checkDownloadInfo(buf.toString());  
    }  
    catch (Exception e) {  
        Log.e(getClass().getSimpleName(),  
            "Exception retrieving update info", e);  
    }  
    finally {  
        if (reader != null) {  
            try {  
                reader.close();  
            }  
            catch (IOException e) {  
                Log.e(getClass().getSimpleName(),  
                    "Exception closing HUC reader", e);  
            }  
        }  
    }  
}
```

In this fairly large chunk of code, we are using `HttpURLConnection` to download `UPDATE_URL`, streaming the resulting JSON into a `StringBuilder`. We then pass the `String` representing the JSON into yet-to-be-implemented `checkDownloadInfo()`

## TUTORIAL #16 - UPDATING THE BOOK

---

method. Along the way, we have exception handling to make sure we clean up our socket connection in case something goes wrong.

Then, add an `UPDATE_BASEDIR` static data member to `DownloadCheckService`, representing the name of a directory on internal storage where our updates will be stored:

```
private static final String UPDATE_BASEDIR="updates";
```

Next, add a `getUpdateBaseDir()` method to `DownloadCheckService` that takes `UPDATE_BASEDIR` and adds it to the `getFilesDir()` `File` returned by a `Context`

```
static File getUpdateBaseDir(Context ctxt) {
    return(new File(ctxt.getFilesDir(), UPDATE_BASEDIR));
}
```

Then, add an `UPDATE_FILENAME` static data member to `DownloadCheckService`, containing the filename to which we will download the update:

```
public static final String UPDATE_FILENAME="book.zip";
```

Next, add an `PREF_PENDING_UPDATE` static data member to `DownloadCheckService`, containing the key in `SharedPreferences` where we will store the local location of an in-flight update:

```
public static final String PREF_PENDING_UPDATE="pendingUpdateDir";
```

Then, add a pair of string resources:

- `update_title`, with a value like `EmPub Lite Update`
- `update_description`, with a value like `A new edition of book content`

The JSON in question that we are downloading will be of the form:

```
{"20120512": "http://misc.commonsware.com/WarOfTheWorlds-Update.zip"}
```

With that in mind, add an implementation of `checkDownloadInfo()` to `DownloadCheckService` as follows:

```
private void checkDownloadInfo(String raw) throws JSONException {
    JSONObject json=new JSONObject(raw);
    String version=json.names().getString(0);
    File localCopy=new File(getUpdateBaseDir(this), version);

    if (!localCopy.exists()) {
```

## TUTORIAL #16 - UPDATING THE BOOK

---

```
PreferenceManager.getDefaultSharedPreferences(this)
    .edit()
    .putString(PREF_PENDING_UPDATE,
        localCopy.getAbsolutePath()).commit();

String url=json.getString(version);
DownloadManager mgr=
    (DownloadManager) getSystemService(DOWNLOAD_SERVICE);
DownloadManager.Request req=
    new DownloadManager.Request(Uri.parse(url));

Environment.getExternalStoragePublicDirectory(Environment.DIRECTORY_DOWNLOADS)
    .mkdirs();

req.setAllowedNetworkTypes(DownloadManager.Request.NETWORK_WIFI
    | DownloadManager.Request.NETWORK_MOBILE)
    .setAllowedOverRoaming(false)
    .setTitle(getString(R.string.update_title))
    .setDescription(getString(R.string.update_description))
    .setDestinationInExternalPublicDir(Environment.DIRECTORY_DOWNLOADS,
        UPDATE_FILENAME);

mgr.enqueue(req);
}
```

We first parse the JSON and get the version number of the update, which is the value of the one-and-only key of our JSON object. We then create a File object representing a directory for that update, a subdirectory of our `getUpdateBaseDir()` directory. If we have already downloaded this update, that directory update's directory will exist by name, and we can skip the download.

Otherwise, we store the directory where we want the update to reside in our `SharedPreferences` under `PREF_PENDING_UPDATE`, for later retrieval by another service.

We then configure and enqueue a `DownloadManager.Request` to have `DownloadManager` download the update (the value for our version's key in the JSON). The resulting ZIP file is downloaded to external storage, in the standard `DIRECTORY_DOWNLOADS` location, under the filename represented by `UPDATE_FILENAME`.

Given this implementation, we need to add three permissions to the manifest:

- `android.permission.INTERNET`
- `android.permission.DOWNLOAD_WITHOUT_NOTIFICATION`

- `android.permission.WRITE_EXTERNAL_STORAGE`

Non-Eclipse users can add the following `<uses-permission>` elements as children of the root `<manifest>` element in `AndroidManifest.xml`:

```
<uses-permission android:name="android.permission.INTERNET"/>
<uses-permission
android:name="android.permission.DOWNLOAD_WITHOUT_NOTIFICATION"/>
<uses-permission android:name="android.permission.WRITE_EXTERNAL_STORAGE"/>
```

Eclipse users can double-click on `AndroidManifest.xml` and switch over to the Permissions tab. There, click the Add... button and choose to add a new “Uses Permission” entry. In the drop-down that appears on right, choose `android.permission.INTERNET`. Repeat that process twice more to add the other two permissions listed above.

### Step #5: Adding a Stub DownloadInstallService

`DownloadManager` will take care of downloading the ZIP file for us. However, once it is downloaded, we need to unZIP it into the desired update directory. And, we cannot do that from a `BroadcastReceiver` triggered by the download being completed, as the unZIP process may take too long.

So, we need another `IntentService` — this one we can call `DownloadInstallService`.

If you wish to make this change using Eclipse’s wizards and tools, follow the instructions in the “Eclipse” section below. Otherwise, follow the instructions in the “Outside of Eclipse” section (appears after the “Eclipse” section).

#### Eclipse

Right click over the `com.commonware.empublite` package in the `src/` folder of your project, and choose `New > Class` from the context menu. Fill in `DownloadInstallService` in the “Name” field. Click the “Browse...” button next to the “Superclass” field and find `IntentService` to set as the superclass. Then, click “Finish” on the new-class dialog to create the `DownloadInstallService` class.

Then, with `DownloadInstallService` open in the editor, paste in the following class definition:

## TUTORIAL #16 - UPDATING THE BOOK

---

```
package com.commonware.empublite;

import android.app.IntentService;
import android.content.Intent;

public class DownloadInstallService extends IntentService {
    public DownloadInstallService() {
        super("DownloadInstallService");
    }

    @Override
    protected void onHandleIntent(Intent intent) {
    }
}
```

You will also need to add a new service node to the list of nodes in the Application sub-tab of `AndroidManifest.xml`, pointing to `DownloadInstallService`, following the same approach that we used for `DownloadCheckService` earlier in this tutorial.

### Outside of Eclipse

Create a `src/com/commonware/empublite/DownloadInstallService.java` source file, with the content shown above. Also add the following `<service>` element as a child of the `<application>` element in your `AndroidManifest.xml` file:

```
<service android:name="DownloadInstallService">
</service>
```

## Step #6: Completing the DownloadCompleteReceiver

Our `DownloadCompleteReceiver` is set up in the manifest to listen for `DownloadManager` broadcasts. We need to confirm that our update has taken place and, if so, arrange to invoke our `DownloadInstallService` to unpack it.

With that in mind, replace the stub `onReceive()` implementation in `DownloadCompleteReceiver` with the following:

```
@Override
public void onReceive(Context ctxt, Intent i) {
    File update=
        new File(
Environment.getExternalStoragePublicDirectory(Environment.DIRECTORY_DOWNLOADS),
        DownloadCheckService.UPDATE_FILENAME);
```

```
if (update.exists()) {
    ctxt.startService(new Intent(ctxt, DownloadInstallService.class));
}
}
```

We create a File object pointing to where DownloadManager should have downloaded the file, and if the File exists, we send the command to DownloadInstallService.

### Step #7: Completing the DownloadInstallService

Now, we can unpack our downloaded ZIP file into the desired directory.

First, define three static data members to DownloadInstallService:

- PREF\_UPDATE\_DIR, the key in SharedPreferences where we will store the directory containing a copy of the book that ModelFragment should load from instead of our assets
- PREF\_PREV\_UPDATE, the key in SharedPreferences where we will store the directory containing the previous copy of the book that ModelFragment might presently be using, but can be safely deleted the next time it goes to load up the book contents
- ACTION\_UPDATE\_READY, the name of a broadcast Intent that we will use to alert our running EmPubLiteActivity that an update was completed and that we can now reload the book contents

```
public static final String PREF_UPDATE_DIR="updateDir";
public static final String PREF_PREV_UPDATE="previousUpdateDir";
public static final String ACTION_UPDATE_READY=
    "com.commonware.empublite.action.UPDATE_READY";
```

Next, replace our stub onHandleIntent() implementation in DownloadInstallService with the following:

```
@Override
protected void onHandleIntent(Intent intent) {
    SharedPreferences prefs=
        PreferenceManager.getDefaultSharedPreferences(this);
    String prevUpdateDir=prefs.getString(PREF_UPDATE_DIR, null);
    String pendingUpdateDir=
        prefs.getString(DownloadCheckService.PREF_PENDING_UPDATE, null);

    if (pendingUpdateDir != null) {
        File root=
            Environment.getExternalStoragePublicDirectory(Environment.DIRECTORY_DOWNLOADS);
```



## TUTORIAL #16 - UPDATING THE BOOK

---

```
File update=new File(root, DownloadCheckService.UPDATE_FILENAME);

try {
    unzip(update, new File(pendingUpdateDir));
    prefs.edit().putString(PREF_PREV_UPDATE, prevUpdateDir)
        .putString(PREF_UPDATE_DIR, pendingUpdateDir).commit();
}
catch (IOException e) {
    Log.e(getClass().getSimpleName(), "Exception unzipping update",
        e);
}

update.delete();

Intent i=new Intent(ACTION_UPDATE_READY);

i.setPackage(getPackageName());
sendOrderedBroadcast(i, null);
}
else {
    Log.e(getClass().getSimpleName(), "null pendingUpdateDir");
}
}
```

Here, we:

- Collect the current update directory (PREF\_UPDATE\_DIR) and the one that we should be unZIPping an update into (PREF\_PENDING\_UPDATE) from SharedPreferences
- Call a to-be-written unzip() method to unZIP the just-downloaded update into the desired destination directory
- Update SharedPreferences to indicate that the just-unZIPped copy is the update to be used from now on (PREF\_UPDATE\_DIR) and that the former update directory can be deleted (PREF\_PREV\_UPDATE)
- Delete the ZIP file, as it is no longer needed
- Send an ACTION\_UPDATE\_READY ordered broadcast, limited to our package via setPackage(), to let the activity know that our work is done

Finally, add the missing unzip() method to DownloadInstallService:

```
private static void unzip(File src, File dest) throws IOException {
    InputStream is=new FileInputStream(src);
    ZipInputStream zis=new ZipInputStream(new BufferedInputStream(is));
    ZipEntry ze;

    dest.mkdirs();

    while ((ze=zis.getNextEntry()) != null) {
        byte[] buffer=new byte[8192];
```

```
int count;
FileOutputStream fos=
    new FileOutputStream(new File(dest, ze.getName()));
BufferedOutputStream out=new BufferedOutputStream(fos);

try {
    while ((count=zis.read(buffer)) != -1) {
        out.write(buffer, 0, count);
    }

    out.flush();
}
finally {
    fos.getFD().sync();
    out.close();
}

zis.closeEntry();
}

zis.close();
}
```

This is a fairly standard Java unZIP-the-whole-ZIP-file implementation, though it does use the Android-recommended `sync()` approach to ensure that our disk writes are flushed.

## Step #8: Updating ModelFragment

ModelFragment needs to know to load our downloaded update, instead of assets, when that update is available. To that end, modify `doInBackground()` of the `ContentsLoadTask` inner class of `ModelFragment` to look like this:

```
@Override
protected Void doInBackground(Context... ctxt) {
    String updateDir=
        prefs.getString(DownloadInstallService.PREF_UPDATE_DIR, null);

    try {
        StringBuilder buf=new StringBuilder();
        InputStream json=null;

        if (updateDir != null && new File(updateDir).exists()) {
            json=
                new FileInputStream(new File(new File(updateDir),
                    "contents.json"));
        }
        else {
            json=ctxt[0].getAssets().open("book/contents.json");
        }
    }
}
```

## TUTORIAL #16 - UPDATING THE BOOK

---

```
BufferedReader in=
    new BufferedReader(new InputStreamReader(json));
String str;

while ((str=in.readLine()) != null) {
    buf.append(str);
}

in.close();

if (updateDir != null && new File(updateDir).exists()) {
    localContents=
        new BookContents(new JSONObject(buf.toString()),
            new File(updateDir));
}
else {
    localContents=
        new BookContents(new JSONObject(buf.toString()));
}
}
catch (Exception e) {
    this.e=e;
}

String prevUpdateDir=
    prefs.getString(DownloadInstallService.PREF_PREV_UPDATE, null);

if (prevUpdateDir != null) {
    File toBeDeleted=new File(prevUpdateDir);

    if (toBeDeleted.exists()) {
        deleteDir(toBeDeleted);
    }
}

return(null);
}
```

The differences are:

- We read the PREF\_UPDATE\_DIR preference out of prefs
- If the update directory is not null and that directory actually exists, we load the JSON out of it instead of out of assets
- If the update directory is not null and that directory actually exists, we tell the BookContents to use that directory instead of assets
- We see if there is a value for PREF\_PREV\_UPDATE, and if the value and the pointed-to directory exists, we delete that directory using a to-be-implemented deleteDir() method

## TUTORIAL #16 - UPDATING THE BOOK

---

This requires revisions to the data members, constructor, and `getChapterFile()` method of `BookContents`, to support a new `updateDir` value:

```
package com.commonware.empublite;

import android.net.Uri;
import java.io.File;
import org.json.JSONArray;
import org.json.JSONObject;

public class BookContents {
    JSONObject raw=null;
    JSONArray chapters;
    File updateDir=null;

    BookContents(JSONObject raw) {
        this(raw, null);
    }

    BookContents(JSONObject raw, File updateDir) {
        this.raw=raw;
        this.updateDir=updateDir;
        chapters=raw.optJSONArray("chapters");
    }

    int getChapterCount() {
        return(chapters.length());
    }

    String getChapterFile(int position) {
        JSONObject chapter=chapters.optJSONObject(position);

        if (updateDir != null) {
            return(Uri.fromFile(new File(updateDir,
chapter.optString("file"))).toString());
        }

        return("file:///android_asset/book/"+chapter.optString("file"));
    }

    String getTitle() {
        return(raw.optString("title"));
    }
}
```

This also requires that we add the `deleteDir()` method to `ModelFragment`:

```
private static boolean deleteDir(File dir) {
    if (dir.exists() && dir.isDirectory()) {
        File[] children=dir.listFiles();

        for (File child : children) {
```

```
        boolean ok=deleteDir(child);

        if (!ok) {
            return(false);
        }
    }

    return(dir.delete());
}
```

Also, we now have a dependency: ContentsLoadTask needs the preferences that are loaded by PrefsLoadTask. Hence, we can no longer launch these in parallel, but instead must wait on executing the ContentsLoadTask until after PrefsLoadTask is done. This is a surprisingly simple change to deliverModel() in ModelFragment, converting the if (contents == null && contentsTask == null) check to be an else if, chaining to the previous if:

```
synchronized private void deliverModel() {
    if (prefs != null && contents != null) {
        ((EmPubLiteActivity)getActivity()).setupPager(prefs, contents);
    }
    else {
        if (prefs == null && prefsTask == null) {
            prefsTask=new PrefsLoadTask();
            executeAsyncTask(prefsTask,
                getActivity().getApplicationContext());
        }
        else if (contents == null && contentsTask == null) {
            contentsTask=new ContentsLoadTask();
            executeAsyncTask(contentsTask,
                getActivity().getApplicationContext());
        }
    }
}
```

## Step #9: Adding a BroadcastReceiver to EmPubLiteActivity

We also need to catch that broadcast from DownloadInstallService and arrange to reload our book contents once the update is complete.

To do this, in ModelFragment, move the contents of the else if block in deliverModel() to a separate method, named updateBook():

```
void updateBook() {
    contentsTask=new ContentsLoadTask();
}
```

## TUTORIAL #16 - UPDATING THE BOOK

---

```
executeAsyncTask(contentsTask,
                 getActivity().getApplicationContext());
}
```

Then, have `deliverModel()` use `updateBook()`:

```
synchronized private void deliverModel() {
    if (prefs != null && contents != null) {
        ((EmPubLiteActivity)getActivity()).setupPager(prefs, contents);
    }
    else {
        if (prefs == null && prefsTask == null) {
            prefsTask=new PrefsLoadTask();
            executeAsyncTask(prefsTask,
                            getActivity().getApplicationContext());
        }
        else if (contents == null && contentsTask == null) {
            updateBook();
        }
    }
}
```

In `EmPubLiteActivity`, add a `BroadcastReceiver` data member named `onUpdate` that will call `updateBook()` on the `ModelFragment`, then abort the ordered broadcast:

```
private BroadcastReceiver onUpdate=new BroadcastReceiver() {
    public void onReceive(Context ctxt, Intent i) {
        model.updateBook();
        abortBroadcast();
    }
};
```

Then, register that receiver in `onResume()` of `EmPubLiteActivity`, by adding these lines at the end of `onResume()`:

```
@Override
public void onResume() {
    super.onResume();

    if (prefs != null) {
        pager.setKeepScreenOn(prefs.getBoolean(PREF_KEEP_SCREEN_ON, false));
    }

    IntentFilter f=
        new IntentFilter(DownloadInstallService.ACTION_UPDATE_READY);
    f.setPriority(1000);
    registerReceiver(onUpdate, f);
}
```

We are setting the priority to be 1000 in preparation for an upcoming tutorial.

## TUTORIAL #16 - UPDATING THE BOOK

---

Finally, unregister that receiver by adding the following line to the top of `onPause()`:

```
unregisterReceiver(onUpdate);
```

We have one lingering problem: our `BroadcastReceiver` is referring to a model data member that does not exist. That is our `ModelFragment`. Heretofore, we have not needed to call `ModelFragment` from `EmPubLiteActivity`, but now we do, in order to have `ModelFragment` reload the book.

So, add a model data member to `EmPubLiteActivity`:

```
private ModelFragment model=null;
```

Then, adjust the `onCreate()` implementation in `EmPubLiteActivity` to assign a value to `model`, whether we create a new `ModelFragment` or access the one we created earlier when the activity was first created:

```
@Override
protected void onCreate(Bundle savedInstanceState) {
    super.onCreate(savedInstanceState);

    if (getSupportFragmentManager().findFragmentByTag(MODEL) == null) {
        model=new ModelFragment();
        getSupportFragmentManager().beginTransaction().add(model, MODEL)
            .commit();
    }
    else {
        model=
            (ModelFragment)getSupportFragmentManager().findFragmentByTag(MODEL);
    }

    setContentView(R.layout.main);

    pager=(ViewPager)findViewById(R.id.pager);
    getSupportActionBar().setHomeButtonEnabled(true);
}
```

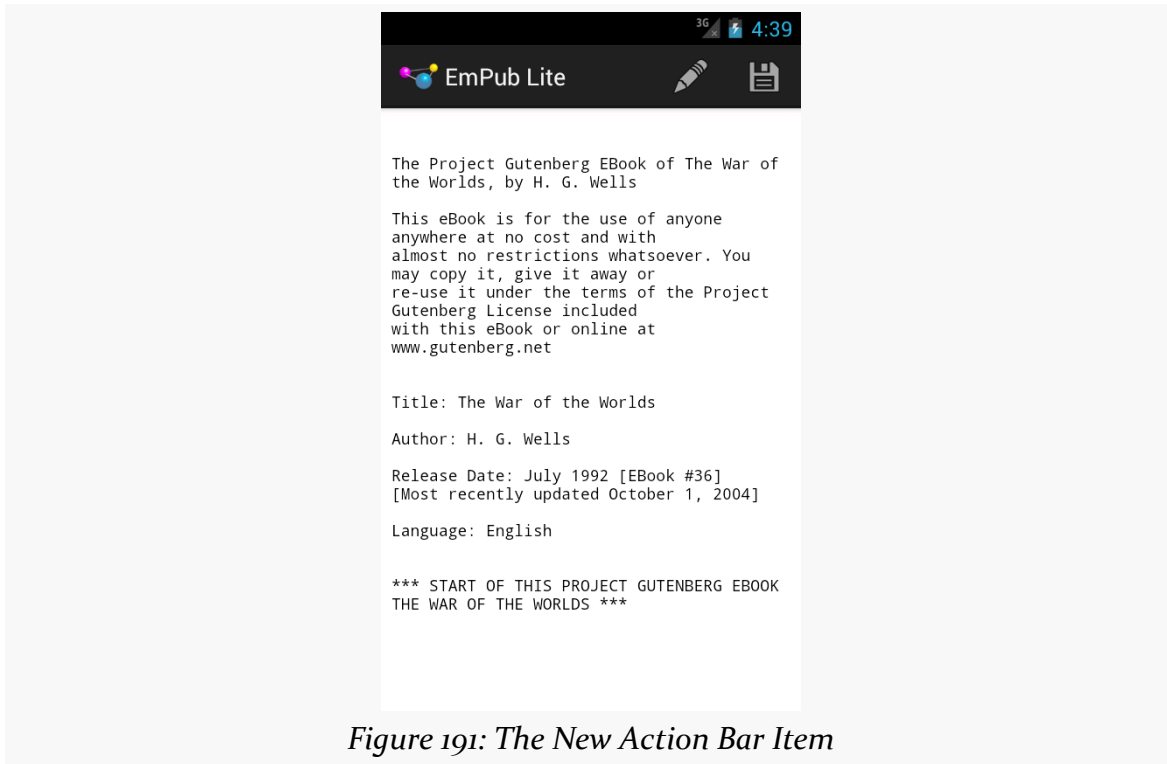
We also have one other tweak to make. `ContentsAdapter` used to have the responsibility of adding the file:///android\_asset/book/ to the path returned by `BookContents`. That is no longer valid, as `BookContents` returns the full path (whether local or to an asset). So, change `getItem()` in `ContentsAdapter` to be:

```
@Override
public Fragment getItem(int position) {
    return(SimpleContentFragment.newInstance(contents.getChapterFile(position)));
}
```

## TUTORIAL #16 - UPDATING THE BOOK

---

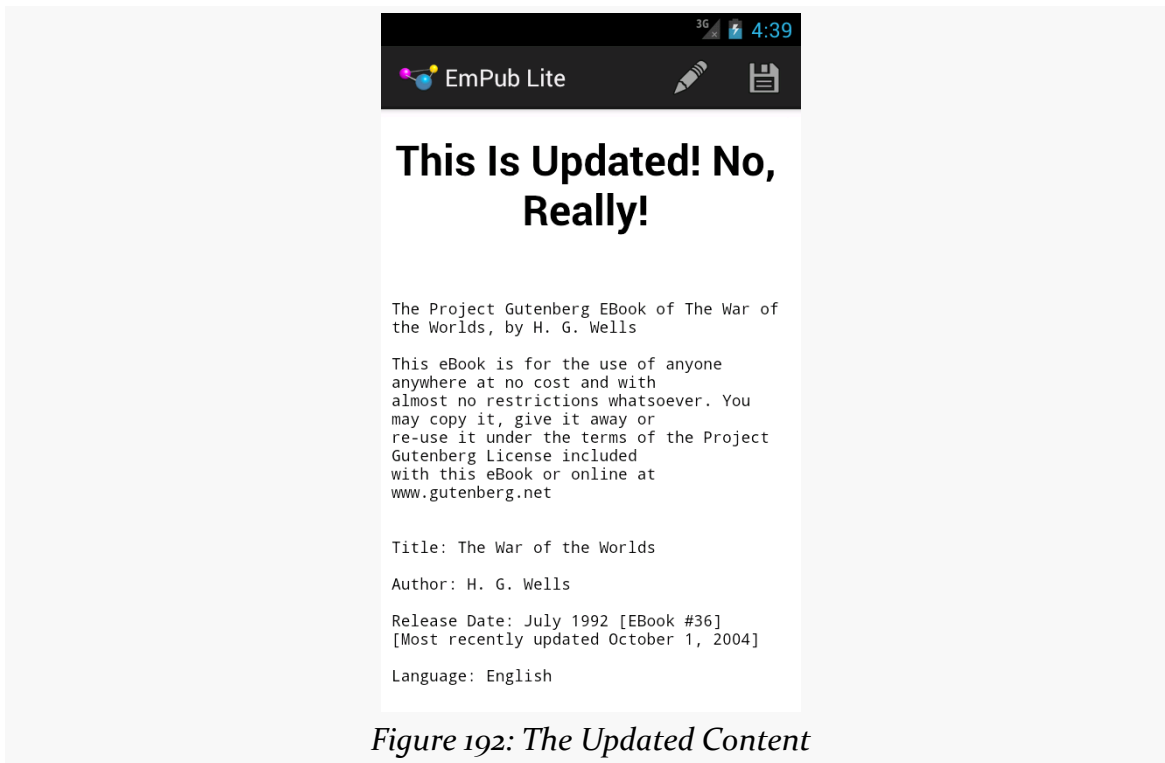
At this point, if you build and run the app, you will see the update action bar item (looks like a floppy disk):



*Figure 191: The New Action Bar Item*

Pressing that and waiting a moment should cause your book to be updated with new contents downloaded from the Internet:





## Step #10: Discussing the Flaws

The tutorials in this book are not meant to be production-grade code. That being said, the approaches we are taking in this specific tutorial are weaker than usual.

Notably, the way we have set up `DownloadCompleteReceiver` will cause it to receive broadcasts for any use of `DownloadManager`. There is no good way to have `DownloadManager` only tell *us* about *our* downloads. However, we could use some more advanced techniques to have `DownloadCompleteReceiver` be disabled except during the window of time when we are performing the actual download.

We also do not take any steps to limit the downloads. If the user taps the action bar item twice, we might happily kick off two downloads.

## In Our Next Episode...

... we will [update the book's contents ourselves, periodically](#) in the background.

# AlarmManager and the Scheduled Service Pattern

---

Many applications have the need to get control every so often to do a bit of work. And, many times, those applications need to get control in the background, regardless of what the user may be doing (or not doing) at the time.

The solution, in most cases, is to use `AlarmManager`, which is roughly akin to `cron` on Linux and OS X and `Scheduled Tasks` in Windows. You teach `AlarmManager` when you want to get control back, and `AlarmManager` will give you control at that time.

## Scenarios

The two main axes to consider with scheduled work is frequency and foreground (vs. background).

If you have an activity that needs to get control every second, the simplest approach is to use a `postDelayed()` loop, scheduling a `Runnable` to be invoked after a certain delay, where the `Runnable` reschedules itself to be invoked after the delay in addition to doing some work:

```
public void onCreate(Bundle icle) {
    // other work here

    someWidget.postDelayed(everySecond, 1000);
}

Runnable everySecond=new Runnable() {
    public void run() {
        // do periodic work
        anyOldWidget.postDelayed(everySecond, 1000);
    }
}
```

```
}  
};
```

This has the advantages of giving you control back on the main application thread and avoiding the need for any background threads.

On the far other end of the spectrum, you may need to get control on a somewhat slower frequency (e.g., every 15 minutes), and do so in the background, even if nothing of your app is presently running. You might need to poll some Web server for new information, such as downloading updates to an RSS feed. This is the scenario that AlarmManager excels at. While `postDelayed()` works *inside* your process (and therefore does not work if you no longer have a process), AlarmManager maintains its schedule *outside* of your process. Hence, it can arrange to give you control, even if it has to start up a new process for you along the way.

## Options

There are a variety of things you will be able to configure about your scheduled alarms with AlarmManager.

### Wake Up... Or Not?

The biggest one is whether or not the scheduled event should wake up the device.

A device goes into a sleep mode shortly after the screen goes dark. During this time, nothing at the application layer will run, until something wakes up the device. Waking up the device does not necessarily turn on the screen — it may just be that the CPU starts running your process again.

If you choose a “wakeup”-style alarm, Android will wake up the device to give you control. This would be appropriate if you need this work to occur even if the user is not actively using the device, such as your app checking for critical email messages in the middle of the night. However, it does drain the battery some.

Alternatively, you can choose an alarm that will not wake up the device. If your desired time arrives and the device is asleep, you will not get control until something else wakes up the device.

### Repeating... Or Not?

You can create a “one-shot” alarm, to get control once at a particular time in the future. Or, you can create an alarm that will give you control periodically, at a fixed period of your choice (e.g., every 15 minutes).

If you need to get control at multiple times, but the schedule is irregular, use a “one-shot” alarm for the nearest time, where you do your work *and* schedule a “one-shot” alarm for the next-nearest time. This would be appropriate for scenarios like a calendar application, where you need to let the user know about upcoming appointments, but the times for those appointments may not have any fixed schedule.

However, for most polling operations (e.g., checking for new messages every NN minutes), a repeating alarm will typically be the better answer.

### Inexact... Or Not?

If you do choose a repeating alarm, you will have your choice over having (relatively) precise control over the timing of event or not.

If you choose an “inexact” alarm, while you will provide Android with a suggested time for the first event and a period for subsequent events, Android reserves the right to shift your schedule somewhat, so it can process your events and others around the same time. This is particularly important for “wakeup”-style alarms, as it is more power-efficient to wake up the device fewer times, so Android will try to combine multiple apps’ events to be around the same time to minimize the frequency of waking up the device.

However, inexact alarms are annoying to test and debug, simply because you do not have control over when they will be invoked. Hence, during development, you might start with an exact alarm, then switch to inexact alarms once most of your business logic is debugged.

### Absolute Time... Or Not?

As part of the alarm configuration, you will tell Android when the event is to occur (for one-shot alarms) or when the event is to *first* occur (for repeating alarms). You can provide that time in one of two ways:

- An absolute “real-time clock” time (e.g., 4am tomorrow), or
- A time relative to now

For most polling operations, particularly for periods more frequent than once per day, specifying the time relative to now is easiest. However, some alarms may need to tie into “real world time”, such as alarm clocks and calendar alerts — for those, you will need to use the real-time clock (typically by means of a Java Calendar object) to indicate when the event should occur.

### What Happens (Or Not???)

And, of course, you will need to tell Android what to do when each of these timer events occurs. You will do that in the form of supplying a PendingIntent. First mentioned in [the chapter on services](#), a PendingIntent is a Parcelable object, one that indicates an operation to be performed upon an Intent:

- start an activity
- start a service
- send a broadcast

While the service chapter discussed an Android activity using `createPendingResult()` to craft such a PendingIntent, that is usually not very useful for AlarmManager, as the PendingIntent will only be valid so long as the activity is in the foreground. Instead, there are static factory methods on PendingIntent that you will use instead (e.g., `getBroadcast()` to create a PendingIntent that calls `sendBroadcast()` on a supplied Intent).

## A Simple Example

A trivial sample app using AlarmManager can be found in [AlarmManager/Simple](#).

This application consists of a single activity, `SimpleAlarmDemoActivity`, that will both set up an alarm schedule and respond to alarms:

```
package com.commonware.android.alarm;

import android.app.Activity;
import android.app.AlarmManager;
import android.app.PendingIntent;
import android.content.Intent;
import android.os.Bundle;
import android.os.SystemClock;
```

## ALARM MANAGER AND THE SCHEDULED SERVICE PATTERN

---

```
import android.widget.Toast;

public class SimpleAlarmDemoActivity extends Activity {
    private static final int ALARM_ID=1337;
    private static final int PERIOD=5000;
    private PendingIntent pi=null;
    private AlarmManager mgr=null;

    @Override
    public void onCreate(Bundle savedInstanceState) {
        super.onCreate(savedInstanceState);
        setContentView(R.layout.main);

        mgr=(AlarmManager) getSystemService(ALARM_SERVICE);
        pi=createPendingResult(ALARM_ID, new Intent(), 0);
        mgr.setRepeating(AlarmManager.ELAPSED_REALTIME,
            SystemClock.elapsedRealtime() + PERIOD, PERIOD, pi);
    }

    @Override
    public void onDestroy() {
        mgr.cancel(pi);

        super.onDestroy();
    }

    @Override
    protected void onActivityResult(int requestCode, int resultCode,
        Intent data) {
        if (requestCode == ALARM_ID) {
            Toast.makeText(this, R.string.toast, Toast.LENGTH_SHORT).show();
        }
    }
}
```

In `onCreate()`, in addition to setting up the “hello, world”-ish UI, we:

- Obtain an instance of `AlarmManager`, by calling `getSystemService()`, asking for the `ALARM_SERVICE`, and casting the result to be an `AlarmManager`
- Create a `PendingIntent` by calling `createPendingResult()`, supplying an empty `Intent` as our “result” (since we do not really need it here)
- Calling `setRepeating()` on `AlarmManager`

The call to `setRepeating()` is a bit complex, taking four parameters:

1. The type of alarm we want, in this case `ELAPSED_REALTIME`, indicating that we want to use a relative time base for when the first event should occur (i.e., relative to now) and that we do not need to wake up the device out of any sleep mode

2. The time when we want the first event to occur, in this case specified as a time delta in milliseconds (PERIOD) added to “now” as determined by `SystemClock.elapsedRealtime()` (the number of milliseconds since the device was last rebooted)
3. The number of milliseconds to occur between events
4. The `PendingIntent` to invoke for each of these events

When the event occurs, since we used `createPendingResult()` to create the `PendingIntent`, our activity gets control in `onActivityResult()`, where we simply display a `Toast` (if the event is for our alarm’s request ID). This continues until the activity is destroyed (e.g., pressing the `BACK` button), at which time we `cancel()` the alarm, supplying a `PendingIntent` to indicate which alarm to cancel. While here we use the same `PendingIntent` object as we used for scheduling the alarm, that is not required — it merely has to be an *equivalent* `PendingIntent`, meaning:

- The Intent inside the `PendingIntent` matches the scheduled alarm’s Intent, in terms of component, action, data (`Uri`), MIME type, and categories
- The ID of the `PendingIntent` (here, `ALARM_ID`) must also match

Running this simply brings up a `Toast` every five seconds until you `BACK` out of the activity.

## The Four Types of Alarms

In the above sample, we used `ELAPSED_REALTIME` as the type of alarm. There are three others:

- `ELAPSED_REALTIME_WAKEUP`
- `RTC`
- `RTC_WAKEUP`

Those with `_WAKEUP` at the end will wake up a device out of sleep mode to execute the `PendingIntent` — otherwise, the alarm will wait until the device is awake for other means.

Those that begin with `ELAPSED_REALTIME` expect the second parameter to `setRepeating()` to be a timestamp based upon `SystemClock.elapsedRealtime()`. Those that begin with `RTC`, however, expect the second parameter to be based upon `System.currentTimeMillis()`, the classic Java “what is the current time in milliseconds since the Unix epoch” method.

## When to Schedule Alarms

The sample, though, begs a bit of a question: when are we supposed to set up these alarms? The sample just does so in `onCreate()`, but is that sufficient?

For most apps, the answer is “no”. Here are the three times that you will need to ensure that your alarms get scheduled:

### When User First Runs Your App

When your app is first installed, none of your alarms are set up, because your code has not yet run to schedule them. There is no means of setting up alarm information in the manifest or something that might automatically kick in.

Hence, you will need to schedule your alarms when the user first runs your app.

As a simplifying measure — and to cover another scenario outlined below — you might be able to simply get away with scheduling your alarms *every* time the user runs your app, as the sample app shown above does. This works for one-shot alarms (using `set()`) and for alarms with short polling periods, and it works because setting up a new alarm schedule for an equivalent `PendingIntent` will replace the old schedule. However, for repeating alarms with slower polling periods, it may excessively delay your events. For example, suppose you have an alarm set to go off every 24 hours, and the user happens to run your app 5 minutes before the next event was to occur — if you blindly reschedule the alarm, instead of going off in 5 minutes, it might not go off for another 24 hours.

There are more sophisticated approaches for this (e.g., using a `SharedPreferences` value to determine if your app has run before or not).

### On Boot

The alarm schedule for alarm manager is wiped clean on a reboot, unlike `cron` or Windows Scheduled Tasks. Hence, you will need to get control at boot time to re-establish your alarms, if you want them to start up again after a reboot. We will examine this process a bit later in this chapter.



## After a Force-Stop

There are other events that could cause your alarms to become unscheduled. The best example of this is if the user goes into the Settings app and presses “Force Stop” for your app. At this point, on Android 3.1+, nothing of your code will run again, until the user manually launches some activity of yours.

If you are rescheduling your alarms every time your app runs, this will be corrected the next time the user launches your app. And, by definition, you cannot do anything until the user runs one of your activities, anyway.

If you are trying to avoid rescheduling your alarms on each run, though, you have a couple of options.

One is to record the time when your alarm-triggered events occur, each time they occur, such as by updating a `SharedPreferences`. When the user launches one of your activities, you check the last-event time — if it was too long ago (e.g., well over your polling period), you assume that the alarm had been canceled, and you reschedule it.

Another is to rely on `FLAG_NO_CREATE`. You can pass this as a parameter to any of the `PendingIntent` factory methods, to indicate that Android should only return an *existing* `PendingIntent` if there is one, and not create one if there is not:

```
PendingIntent pi=PendingIntent.getBroadcast(ctxt, 0, i,  
PendingIntent.FLAG_NO_CREATE);
```

If the `PendingIntent` is `null`, your alarm has been canceled — otherwise, Android would already have such a `PendingIntent` and would have returned it to you. This feels a bit like a side-effect, so we cannot rule out the possibility that, in future versions of Android, this technique could result in false positives (`null` `PendingIntent` despite the scheduled alarm) or false negatives (non-`null` `PendingIntent` despite a canceled alarm).

## Get Moving, First Thing

If you want to establish your alarms at boot time, to cope with a reboot wiping out your alarm schedule, you will need to arrange to have a `BroadcastReceiver` get control at boot time.

### The Permission

In order to be notified when the device has completed its system boot process, you will need to request the `RECEIVE_BOOT_COMPLETED` permission. Without this, even if you arrange to receive the boot broadcast Intent, it will not be dispatched to your receiver.

As the Android documentation describes it:

Though holding this permission does not have any security implications, it can have a negative impact on the user experience by increasing the amount of time it takes the system to start and allowing applications to have themselves running without the user being aware of them. As such, you must explicitly declare your use of this facility to make that visible to the user.

### The Receiver Element

There are two ways you can receive a broadcast Intent. One is to use `registerReceiver()` from an existing Activity, Service, or ContentProvider. The other is to register your interest in the Intent in the manifest in the form of a `<receiver>` element:

```
<?xml version="1.0" encoding="utf-8"?>
<manifest android:versionCode="1"
    android:versionName="1.0"
    package="com.commonware.android.sysevents.boot"
    xmlns:android="http://schemas.android.com/apk/res/android">

    <uses-sdk android:minSdkVersion="3"
        android:targetSdkVersion="6" />
    <supports-screens android:largeScreens="false"
        android:normalScreens="true"
        android:smallScreens="false" />
    <uses-permission android:name="android.permission.RECEIVE_BOOT_COMPLETED" />
    <application android:icon="@drawable/cw"
        android:label="@string/app_name">
        <receiver android:name=".OnBootReceiver">
            <intent-filter>
                <action android:name="android.intent.action.BOOT_COMPLETED" />
            </intent-filter>
        </receiver>
    </application>
</manifest>
```

The above `AndroidManifest.xml`, from the [SystemEvents/OnBoot](#) sample project, shows that we have registered a broadcast receiver named `OnBootReceiver`, set to be given control when the `android.intent.action.BOOT_COMPLETED` Intent is broadcast.

In this case, we have no choice but to implement our receiver this way — by the time any of our other components (e.g., an Activity) were to get control and be able to call `registerReceiver()`, the `BOOT_COMPLETED` Intent will be long gone.

### The Receiver Implementation

Now that we have told Android that we would like to be notified when the boot has completed, and given that we have been granted permission to do so by the user, we now need to actually do something to receive the Intent. This is a simple matter of creating a `BroadcastReceiver`, such as seen in the `OnBootReceiver` implementation shown below:

```
package com.commonware.android.sysevents.boot;

import android.content.BroadcastReceiver;
import android.content.Context;
import android.content.Intent;
import android.util.Log;

public class OnBootReceiver extends BroadcastReceiver {
    @Override
    public void onReceive(Context context, Intent intent) {
        Log.d("OnBootReceiver", "Hi, Mom!");
    }
}
```

A `BroadcastReceiver` is not a `Context`, and so it gets passed a suitable `Context` object in `onReceive()` to use for accessing resources and the like. The `onReceive()` method also is passed the `Intent` that caused our `BroadcastReceiver` to be created, in case there are “extras” we need to pull out (none in this case).

In `onReceive()`, we can do whatever we want, subject to some limitations:

- We are not a `Context`, like an Activity, so we cannot directly modify the UI
- If we want to do anything significant, it is better to delegate that logic to a service that we start from here (e.g., calling `startService()` on the supplied `Context`) rather than actually doing it here, since `BroadcastReceiver` implementations need to be fast

- We cannot start any background threads, directly or indirectly, since the `BroadcastReceiver` gets discarded as soon as `onReceive()` returns

In this case, we simply log the fact that we got control.

To test this, install it on an emulator (or device), shut down the emulator, then restart it.

### New Behavior With Android 3.1

It used to be that Android applications registering a `BOOT_COMPLETED` `BroadcastReceiver` would get control at boot time. Starting with Android 3.1, that may or may not occur.

If you install an application that registers a `BOOT_COMPLETED` receiver, and simply restart the Android 3.1 device, the receiver does not get control at boot time. It appears that the user has to start up an activity in that application first (e.g., from the launcher) before Android will deliver a `BOOT_COMPLETED` Intent to that application.

Google has long said that users should launch an activity from the launcher first, before that application can do much. Preventing `BOOT_COMPLETED` from being delivered until the first activity is launched is a logical extension of the same argument.

Most apps will be OK with this change. For example, if your boot receiver is there to establish an `AlarmManager` schedule, you also needed to establish that schedule when the app is first run, so the user does not have to reboot their phone just to set up your alarms. That pattern does not change – it is just that if the user happens to reboot the phone, it will not set up your alarms, until the user runs one of your activities.

### Archetype: Scheduled Service Polling

Given that we now know how to get control at boot time, we can return our attention to `AlarmManager`

The classic `AlarmManager` scenario is where you want to do a chunk of work, in the background, on a periodic basis. This is fairly simple to set up in Android, though perhaps not quite as simple as you might think.

### The Main Application Thread Strikes Back

When an `AlarmManager`-triggered event occurs, it is very likely that your application is not running. This means that the `PendingIntent` is going to have to start up your process to have you do some work. Since everything that a `PendingIntent` can do intrinsically gives you control on your main application thread, you are going to have to determine how you want to move your work to a background thread.

One approach is to use a `PendingIntent` created by `getService()`, and have it send a command to an `IntentService` that you write. Since `IntentService` does its work on a background thread, you can take whatever time you need, without interfering with the behavior of the main application thread. This is particularly important when:

- The `AlarmManager`-triggered event happens to occur when the user happens to have one of your activities in the foreground, so you do not freeze the UI, or
- You want the same business logic to be executed on demand by the user, such as via an action bar item, as once again you do not want to freeze the UI

### Examining a Sample

An incrementally-less-trivial sample app using `AlarmManager` for the scheduled service pattern can be found in [AlarmManager/Scheduled](#).

This application consists of three components: a `BroadcastReceiver`, a `Service`, and an `Activity`.

This sample demonstrates scheduling your alarms at two points in your app:

- At boot time
- When the user runs the activity

For the boot-time scenario, we need a `BroadcastReceiver` set up to receive the `ACTION_BOOT_COMPLETED` broadcast, with the appropriate permission. So, we set that up, along with our other components, in the manifest:

```
<?xml version="1.0" encoding="utf-8"?>
<manifest xmlns:android="http://schemas.android.com/apk/res/android"
    package="com.commonware.android.schedsvc"
    android:versionCode="1"
```

## ALARM MANAGER AND THE SCHEDULED SERVICE PATTERN

---

```
android:versionName="1.0">

<uses-sdk
    android:minSdkVersion="7"
    android:targetSdkVersion="11"/>

<uses-permission android:name="android.permission.RECEIVE_BOOT_COMPLETED"/>

<application
    android:icon="@drawable/ic_launcher"
    android:label="@string/app_name">
    <activity
        android:name=".ScheduledServiceDemoActivity"
        android:label="@string/app_name"
        android:theme="@android:style/Theme.NoDisplay">
        <intent-filter>
            <action android:name="android.intent.action.MAIN"/>

            <category android:name="android.intent.category.LAUNCHER"/>
        </intent-filter>
    </activity>

    <receiver android:name="PollReceiver">
        <intent-filter>
            <action android:name="android.intent.action.BOOT_COMPLETED"/>
        </intent-filter>
    </receiver>

    <service android:name="ScheduledService">
    </service>
</application>

</manifest>
```

The PollReceiver has its onReceive() method, to be called at boot time, which delegates its work to a scheduleAlarms() static method, so that logic can also be used by our activity:

```
package com.commonware.android.schedsvc;

import android.app.AlarmManager;
import android.app.PendingIntent;
import android.content.BroadcastReceiver;
import android.content.Context;
import android.content.Intent;
import android.os.SystemClock;

public class PollReceiver extends BroadcastReceiver {
    private static final int PERIOD=5000;

    @Override
    public void onReceive(Context ctxt, Intent i) {
        scheduleAlarms(ctxt);
    }
}
```

## ALARM MANAGER AND THE SCHEDULED SERVICE PATTERN

---

```
}  
  
static void scheduleAlarms(Context ctxt) {  
    AlarmManager mgr=  
        (AlarmManager)ctxt.getSystemService(Context.ALARM_SERVICE);  
    Intent i=new Intent(ctxt, ScheduledService.class);  
    PendingIntent pi=PendingIntent.getService(ctxt, 0, i, 0);  
  
    mgr.setRepeating(AlarmManager.ELAPSED_REALTIME,  
        SystemClock.elapsedRealtime() + PERIOD, PERIOD, pi);  
}  
}
```

The `scheduleAlarms()` method retrieves our `AlarmManager`, creates a `PendingIntent` designed to call `startService()` on our `ScheduledService`, and schedules an exact repeating alarm to have that command be sent every five seconds.

The `ScheduledService` itself is the epitome of “trivial”, simply logging a message to `LogCat` on each command:

```
package com.commonware.android.schedsvc;  
  
import android.app.IntentService;  
import android.content.Intent;  
import android.util.Log;  
  
public class ScheduledService extends IntentService {  
    public ScheduledService() {  
        super("ScheduledService");  
    }  
  
    @Override  
    protected void onHandleIntent(Intent intent) {  
        Log.d(getClass().getSimpleName(), "I ran!");  
    }  
}
```

That being said, because this is an `IntentService`, we could do much more in `onHandleIntent()` and not worry about tying up the main application thread.

Our activity — `ScheduledServiceDemoActivity` — is set up with `Theme.NoDisplay` in the manifest, never calls `setContentView()`, and calls `finish()` right from `onCreate()`. As a result, it has no UI. It simply calls `scheduleAlarms()` and raises a `Toast` to indicate that the alarms are indeed scheduled:

```
package com.commonware.android.schedsvc;  
  
import android.app.Activity;  
import android.os.Bundle;
```

```
import android.widget.Toast;

public class ScheduledServiceDemoActivity extends Activity {
    @Override
    public void onCreate(Bundle savedInstanceState) {
        super.onCreate(savedInstanceState);

        PollReceiver.scheduleAlarms(this);

        Toast.makeText(this, R.string.alarms_scheduled, Toast.LENGTH_LONG)
            .show();
        finish();
    }
}
```

On Android 3.1+, we also need this activity to move our application out of the stopped state and allow that boot-time BroadcastReceiver to work.

If you run this app on a device or emulator, after seeing the Toast, messages will appear in LogCat every five seconds, even though you have no activity running.

## Staying Awake at Work

The sample shown above works... most of the time.

However, it has a flaw: the device might fall asleep before our service can complete its work, if we woke it up out of sleep mode to process the event.

To understand where this flaw would appear, and to learn how to address it, we need to think a bit more about the event flows and timing of the code we are executing.

## Mind the Gap

For a `_WAKEUP`-style alarm, Android makes precisely one guarantee: *if* the `PendingIntent` supplied to `AlarmManager` for the alarm is one created by `getBroadcast()` to send a broadcast `Intent`, Android will ensure that the device will stay awake long enough for `onReceive()` to be completed. Anything beyond that is not guaranteed.

In the sample shown above, we are not using `getBroadcast()`. We are taking the more straightforward approach of sending the command directly to the service via a `getService()` `PendingIntent`. Hence, Android makes no guarantees about what happens after `AlarmManager` wakes up the device, and the device could fall back asleep before our `IntentService` completes processing of `onHandleIntent()`.



### The WakefulIntentService

For our trivial sample, where we are merely logging to LogCat, we could simply move that logic out of an `IntentService` and into a `BroadcastReceiver`. Then, Android would ensure that the device would stay awake long enough for us to do our work in `onReceive()`.

The problem is that `onReceive()` is called on the main application thread, so we cannot spend much time in that method. And, since our alarm event might occur when nothing else of our code is running, we need to have our `BroadcastReceiver` registered in the manifest, rather than via `registerReceiver()`. A side effect of this is that we cannot fork threads or do other things in `onReceive()` that might live past `onReceive()` yet be “owned” by the `BroadcastReceiver` itself. Besides, Android only ensures that the device will stay awake until `onReceive()` returns, so even if we did fork a thread, the device might fall asleep before that thread can complete its work.

Enter the `WakefulIntentService`.

`WakefulIntentService` is a reusable component, published by the author of this book. You can download it as an Android library project or [as a JAR](#) from [a GitHub repository](#). It is open source, licensed under the Apache License 2.0.

`WakefulIntentService` allows you to implement “the handoff pattern”:

- You add the JAR or library project to your project
- You create a subclass of `WakefulIntentService` to do your background work, putting that business logic in a `doWakefulWork()` method instead of `onHandleIntent()` (though it is still called on a background thread)
- You set up your alarm to route to a `BroadcastReceiver` of your design
- Your `BroadcastReceiver` calls `sendWakefulWork()` on the `WakefulIntentService` class, identifying your own subclass of `WakefulIntentService`
- You add a `WAKE_LOCK` permission to your manifest

`WakefulIntentService` will perform a bit of magic to ensure that the device will stay awake long enough for your work to complete in `doWakefulWork()`. Hence, we get the best of both worlds: the device will not fall asleep, and we will not have to worry about tying up the main application thread.

### The Polling Archetype, Revisited

With that in mind, take a peek at the [AlarmManager/Wakeful](#) sample project. This is a near-clone of the previous sample, except that we will use `WakefulIntentService`.

The `libs/` directory of the project contains the `CWAC-WakefulIntentService.jar` library, so we can make use of `WakefulIntentService` in our code.

Our manifest includes the `WAKE_LOCK` permission:

```
<uses-permission android:name="android.permission.WAKE_LOCK"/>
```

Our `PollReceiver` will now serve two roles: handling `ACTION_BOOT_COMPLETED` and handling our alarm events. We can detect which of these cases triggered `onReceive()` by inspecting the broadcast `Intent`, passed into `onReceive()`. We will use an explicit `Intent` for the alarm events, so any `Intent` with an action string must be `ACTION_BOOT_COMPLETED`:

```
package com.commonware.android.wakesvc;

import android.app.AlarmManager;
import android.app.PendingIntent;
import android.content.BroadcastReceiver;
import android.content.Context;
import android.content.Intent;
import android.os.SystemClock;
import com.commonware.cwac.wakeful.WakefulIntentService;

public class PollReceiver extends BroadcastReceiver {
    private static final int PERIOD=5000;

    @Override
    public void onReceive(Context ctxt, Intent i) {
        if (i.getAction() == null) {
            WakefulIntentService.sendWakefulWork(ctxt, ScheduledService.class);
        }
        else {
            scheduleAlarms(ctxt);
        }
    }

    static void scheduleAlarms(Context ctxt) {
        AlarmManager mgr=
            (AlarmManager)ctxt.getSystemService(Context.ALARM_SERVICE);
        Intent i=new Intent(ctxt, PollReceiver.class);
        PendingIntent pi=PendingIntent.getBroadcast(ctxt, 0, i, 0);

        mgr.setRepeating(AlarmManager.ELAPSED_REALTIME_WAKEUP,
            SystemClock.elapsedRealtime() + PERIOD, PERIOD, pi);
    }
}
```

```
}  
}
```

If the Intent is our explicit Intent, we call `sendWakefulWork()` on `WakefulIntentService`, identifying our `ScheduledService` class as being the service that contains our business logic.

The only other change to `PollReceiver` is that we use `getBroadcast()` to create our `PendingIntent`, wrapping our explicit Intent identifying `PollReceiver` itself.

`ScheduledService` has only two changes: it extends `WakefulIntentService` and has the `LogCat` logging in `doWakefulWork()`:

```
package com.commonware.android.wakesvc;  
  
import android.content.Intent;  
import android.util.Log;  
import com.commonware.cwac.wakeful.WakefulIntentService;  
  
public class ScheduledService extends WakefulIntentService {  
    public ScheduledService() {  
        super("ScheduledService");  
    }  
  
    @Override  
    protected void doWakefulWork(Intent intent) {  
        Log.d(getClass().getSimpleName(), "I ran!");  
    }  
}
```

### How the Magic Works

A `WakefulIntentService` keeps the device awake by using a `WakeLock`. A `WakeLock` allows a “userland” (e.g., Android SDK) app to tell the Linux kernel at the heart of Android to keep the device awake, with the CPU powered on, indefinitely, until the `WakeLock` is released.

This can be a wee bit dangerous, as you can accidentally keep the device awake much longer than you need to. That is why using a library like `WakefulIntentService` can be useful — to use more-tested code rather than rolling your own.

# **Tutorial #17 - Periodic Book Updates**

---

Now that we have the ability to update our book's prose by downloading some files from a Web site, we can take the next step: update the book automatically, on a scheduled basis.

This is a continuation of the work we did in [the previous tutorial](#).

You can find [the results of the previous tutorial](#) and [the results of this tutorial](#) in [the book's GitHub repository](#).

Note that if you are importing the previous code to begin work here, you will also need the [copy of ActionBarSherlock in this book's GitHub repository](#), and to make sure that your imported EmPubLite project references the ActionBarSherlock project as a library.

## **Step #1: Adding a Stub UpdateReceiver**

This tutorial is going to use `AlarmManager`. Therefore, we will need a manifest-registered `BroadcastReceiver`, for two reasons:

1. We need to get control at boot time, to restore our alarm schedule
2. We need something to get control when the alarm events occur

In this step, to solve both needs, we will set up a stub `UpdateReceiver`.

If you wish to make this change using Eclipse's wizards and tools, follow the instructions in the "Eclipse" section below. Otherwise, follow the instructions in the "Outside of Eclipse" section (appears after the "Eclipse" section).

### Eclipse

Right click over the `com.commonware.empublite` package in the `src/` folder of your project, and choose `New > Class` from the context menu. Fill in `UpdateReceiver` in the “Name” field. Click the “Browse...” button next to the “Superclass” field and find `BroadcastReceiver` to set as the superclass. Then, click “Finish” on the new-class dialog to create the `UpdateReceiver` class.

You will also need to add a new receiver node to the list of nodes in the Application sub-tab of `AndroidManifest.xml`, pointing to `UpdateReceiver`, following the same approach that we used for other receivers in this application.

However, we also must add an `<intent-filter>` to the `<receiver>` element, identifying the broadcast which we wish to monitor. To do that:

- Click on the Receiver element associated with `UpdateReceiver` in the list of “Application Nodes”
- Click the “Add...” button next to the list of “Application Nodes” and choose “Intent Filter” from the list
- With the “Intent Filter” highlighted in the “Application Nodes” tree, click “Add...” again, this time choosing “Action” from the list
- In the details area on the right, choose `android.intent.action.BOOT_COMPLETED`

Also, in the Permissions sub-tab of the manifest editor, you will need to add the `RECEIVE_BOOT_COMPLETED` permission.

### Outside of Eclipse

Create a `src/com/commonware/empublite/UpdateReceiver.java` source file, with the following Java code:

```
package com.commonware.empublite;

import android.content.BroadcastReceiver;
import android.content.Context;
import android.content.Intent;

public class UpdateReceiver extends BroadcastReceiver {
    @Override
    public void onReceive(Context ctxt, Intent i) {
    }
}
```

## TUTORIAL #17 - PERIODIC BOOK UPDATES

---

Then, add the following `<receiver>` element as a child of the `<application>` element in `AndroidManifest.xml`:

```
<receiver android:name="UpdateReceiver">
  <intent-filter>
    <action android:name="android.intent.action.BOOT_COMPLETED"/>
  </intent-filter>
</receiver>
```

Also, add the following `<uses-permission>` element alongside the other such elements in the manifest:

```
<uses-permission android:name="android.permission.RECEIVE_BOOT_COMPLETED"/>
```

## Step #2: Scheduling the Alarms

Somewhere, we need code to schedule the alarms with `AlarmManager`. Ideally, this will be a static method, one we can use from both `EmPubLiteActivity` (for normal scheduling) and `UpdateReceiver` (for scheduling at boot time).

With that in mind, add the following `scheduleAlarms()` static method to `UpdateReceiver`:

```
static void scheduleAlarm(Context ctxt) {
    AlarmManager mgr=
        (AlarmManager)ctxt.getSystemService(Context.ALARM_SERVICE);
    Intent i=new Intent(ctxt, UpdateReceiver.class);
    PendingIntent pi=PendingIntent.getBroadcast(ctxt, 0, i, 0);
    Calendar cal=Calendar.getInstance();

    cal.set(Calendar.HOUR_OF_DAY, 4);
    cal.set(Calendar.MINUTE, 0);
    cal.set(Calendar.SECOND, 0);
    cal.set(Calendar.MILLISECOND, 0);

    if (cal.getTimeInMillis() < System.currentTimeMillis()) {
        cal.add(Calendar.DAY_OF_YEAR, 1);
    }

    mgr.setRepeating(AlarmManager.RTC_WAKEUP, cal.getTimeInMillis(),
        AlarmManager.INTERVAL_DAY, pi);
}
```

Here we create a broadcast `PendingIntent` pointing back at `UpdateReceiver`, create a `Calendar` object for tomorrow at 4am, and call `setRepeating()` on `AlarmManager` to invoke our `PendingIntent` every day at 4am.

---

## TUTORIAL #17 - PERIODIC BOOK UPDATES

---

Then, modify `onReceive()` of `UpdateReceiver` to use `scheduleAlarm()`, if we are called with an action string (indicating that we are being called due to `ACTION_BOOT_COMPLETED`):

```
@Override
public void onReceive(Context ctxt, Intent i) {
    if (i.getAction() != null) {
        scheduleAlarm(ctxt);
    }
}
```

Finally, at the end of `onCreate()` of `EmPubLiteActivity`, add:

```
UpdateReceiver.scheduleAlarm(this);
```

This will schedule the alarms whenever the app is run. Between that and `UpdateReceiver`, the alarms should be active most of the time during normal operation.

### Step #3: Adding the WakefulIntentService

It is possible that at 4am local time, the user will not be using their device. Therefore, it is possible that the device will fall asleep while we try to download the update. Therefore, we need to switch to using `WakefulIntentService`.

Visit [the WakefulIntentService download page](#) and download the `CWAC-WakefulIntentService.jar` file listed there. Put it in the `libs/` directory of your project, creating that directory if it does not exist. Eclipse users can either:

- Do this work inside of Eclipse (e.g., drag-and-drop the JAR into Package Explorer), or
- Do this work outside of Eclipse (e.g., create the `libs/` directory directly using OS tools), then press <F5> over the project to get Eclipse to scan the project's directory and pick up your changes

Then, modify `DownloadCheckService` and `DownloadInstallService` to inherit from `com.commonware.cwac.wakeful.WakefulIntentService` instead of from `IntentService`. This will cause you to need to rename your `onHandleIntent()` methods to be `doWakefulWork()`.

Also, add the `WAKE_LOCK` permission in the manifest, along with the rest of our permissions. Eclipse users can add this from the Permissions sub-tab of the Eclipse manifest editor; non-Eclipse users can add another `<uses-permission>` element.

### Step #4: Using WakefulIntentService

To correctly use `WakefulIntentService`, we need to use `sendWakefulWork()` to send commands to one, rather than `startService()`.

With that in mind, in `EmPubLiteActivity`, change the `R.id.update` case of the switch statement in `onOptionsItemSelected()` to use `sendWakefulWork()`:

```
case R.id.update:
    WakefulIntentService.sendWakefulWork(this,
                                         DownloadCheckService.class);
    return(true);
```

Similarly, in `DownloadCompleteReceiver`, change `onReceive()` to use `sendWakefulWork()`:

```
package com.commonware.empublite;

import android.content.BroadcastReceiver;
import android.content.Context;
import android.content.Intent;
import android.os.Environment;
import java.io.File;
import com.commonware.cwac.wakeful.WakefulIntentService;

public class DownloadCompleteReceiver extends BroadcastReceiver {
    @Override
    public void onReceive(Context ctxt, Intent i) {
        File update=
            new File(
Environment.getExternalStoragePublicDirectory(Environment.DIRECTORY_DOWNLOADS),
            DownloadCheckService.UPDATE_FILENAME);

        if (update.exists()) {
            WakefulIntentService.sendWakefulWork(ctxt, DownloadInstallService.class);
        }
    }
}
```



## Step #5: Completing the UpdateReceiver

Finally, add an else block to the if statement in `onReceive()` of `UpdateReceiver`, to handle the case where we get control due to the alarm event, so we can use `sendWakefulWork()` to invoke the `DownloadCheckService`:

```
@Override
public void onReceive(Context ctxt, Intent i) {
    if (i.getAction() != null) {
        scheduleAlarm(ctxt);
    }
    else {
        WakefulIntentService.sendWakefulWork(ctxt,
                                             DownloadCheckService.class);
    }
}
```

To test this:

1. In your device or emulator, uninstall the existing `EmPubLite` application, (e.g., by using the `Settings` app)
2. Install and run the revised app in your device or emulator, and confirm that you are viewing the non-updated book, then press `BACK` to exit the activity
3. Temporarily modify the time of your device to be a few minutes before 4am either today (if the current time is between midnight and 4am) or tomorrow (if the current time is after 4am)
4. Find something to pass the time for those few minutes, such as procuring liquid refreshment suitable for the time of day and locale
5. A few minutes after 4am, run the app and confirm that you have downloaded the updated app, then fix your device or emulator's clock back to normal

## In Our Next Episode...

... we will [let the user know about updates from the background](#) via a `Notification`.

# Notifications

---

Pop-up messages. Tray icons and their associated “bubble” messages. Bouncing dock icons. You are no doubt used to programs trying to get your attention, sometimes for good reason.

Your phone also probably chirps at you for more than just incoming calls: low battery, alarm clocks, appointment notifications, incoming text message or email, etc.

Not surprisingly, Android has a whole framework for dealing with these sorts of things, collectively called “notifications”.

## What’s a Notification?

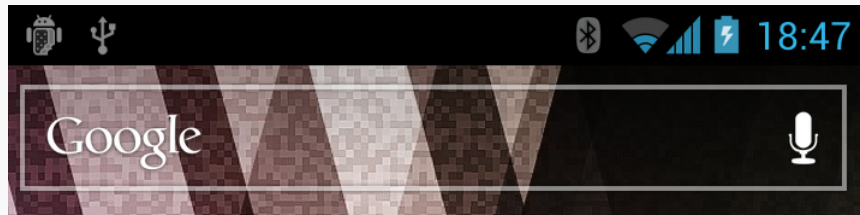
A service, running in the background, needs a way to let users know something of interest has occurred, such as when email has been received. Moreover, the service may need some way to steer the user to an activity where they can act upon the event – reading a received message, for example. For this, Android supplies status bar icons, flashing lights, and other indicators collectively known as “notifications”.

Your current phone may well have such icons, to indicate battery life, signal strength, whether Bluetooth is enabled, and the like. With Android, applications can add their own status bar icons, with an eye towards having them appear only when needed (e.g., a message has arrived).

Notifications will appear in one of two places. On a phone, they will appear in the status bar, on the top of the screen, left-aligned:

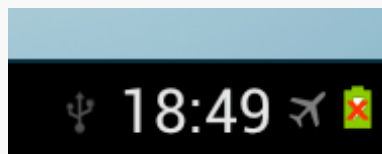
## NOTIFICATIONS

---



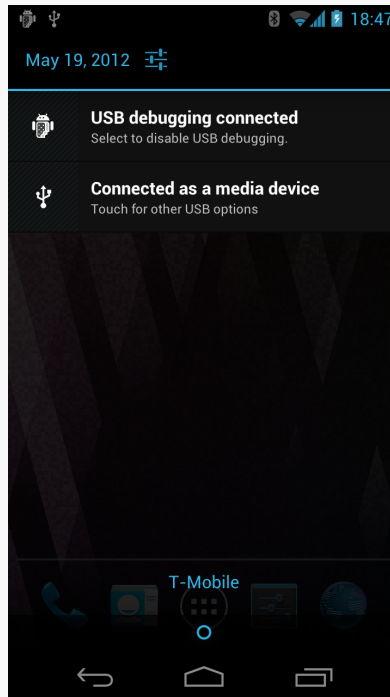
*Figure 193: Notifications, on a Galaxy Nexus*

On a tablet, they will appear in the system bar, on the bottom of the screen, towards the lower-right corner:



*Figure 194: Notifications, on a Galaxy Tab 2*

In either case, you can expand the “notification drawer” to get more details about the active notifications, either by sliding down the status bar:



*Figure 195: Notification Drawer, on a Galaxy Nexus*

or by tapping on the clock on the system bar:

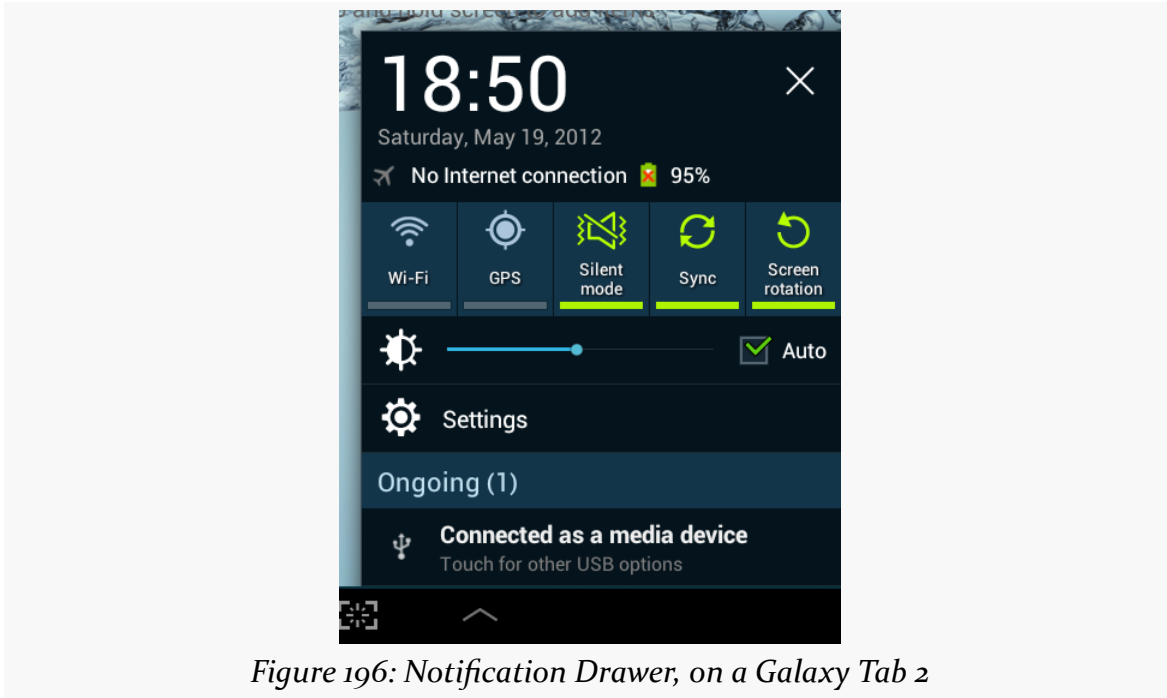


Figure 196: Notification Drawer, on a Galaxy Tab 2

Some notifications will be complex, showing real-time information, such as the progress of a long download. More often, notifications are fairly simple, providing just a couple of lines of information, plus an identifying icon. Tapping on the notification drawer entry will typically trigger some action, such as starting an activity — an email app letting the user know that “you’ve got mail” can have its notification bring up the inbox activity when tapped.

## Showing a Simple Notification

Previously in the book, we had [an example of using DownloadManager](#). There, we would let the user know about the completion of our download by sending a broadcast Intent back to the activity, so it could do something — in our case, display a Toast.

An alternative would be for the background service doing the download to raise a Notification when the download is complete. That would work even if the activity was no longer around (e.g., user pressed BACK to exit it). A modified version of the original DownloadManager sample taking this Notification approach can be found in the [Notifications/DownloadNotify](#) sample project.

## NOTIFICATIONS

---

Our DownloadFragment for triggering the download has two changes:

1. We dispense with the BroadcastReceiver and logic related to it, including disabling and enabling the Button
2. On the Intent we use with startService(), we include not only the Uri of the file to download, but also its MIME type, by calling setDataAndType() on the Intent object

```
package com.commonware.android.downloader;

import android.content.Intent;
import android.net.Uri;
import android.os.Bundle;
import android.view.LayoutInflater;
import android.view.View;
import android.view.ViewGroup;
import android.widget.Button;
import com.actionbarsherlock.app.SherlockFragment;

public class DownloadFragment extends SherlockFragment implements
    View.OnClickListener {
    private Button b=null;

    @Override
    public View onCreateView(LayoutInflater inflater, ViewGroup parent,
        Bundle savedInstanceState) {
        View result=inflater.inflate(R.layout.main, parent, false);

        b=(Button)result.findViewById(R.id.button);
        b.setOnClickListener(this);

        return(result);
    }

    @Override
    public void onClick(View v) {
        Intent i=new Intent(getActivity(), Downloader.class);

        i.setDataAndType(Uri.parse("http://commonware.com/Android/excerpt.pdf"),
            "application/pdf");

        getActivity().startService(i);
        getActivity().finish();
    }
}
```

The download logic in the onHandleIntent() method of Downloader is nearly identical. The difference is that at the end, rather than sending a broadcast Intent, we call a private raiseNotification() method. We also call this method if there is an exception during the download. The raiseNotification() method takes the

## NOTIFICATIONS

---

Intent command that was delivered to `onHandleIntent()`, the File object representing the downloaded results (if we succeeded), and the Exception that was raised (if we crashed). As one might guess given the method's name, `raiseNotification()` will raise a Notification:

```
private void raiseNotification(Intent inbound, File output,
                               Exception e) {
    NotificationCompat.Builder b=new NotificationCompat.Builder(this);

    b.setAutoCancel(true).setDefaults(Notification.DEFAULT_ALL)
      .setWhen(System.currentTimeMillis());

    if (e == null) {
        b.setTitle(getString(R.string.download_complete))
          .setText(getString(R.string.fun))
          .setSmallIcon(android.R.drawable.stat_sys_download_done)
          .setTicker(getString(R.string.download_complete));

        Intent outbound=new Intent(Intent.ACTION_VIEW);

        outbound.setDataAndType(Uri.fromFile(output), inbound.getType());

        b.setContentIntent(PendingIntent.getActivity(this, 0, outbound, 0));
    }
    else {
        b.setTitle(getString(R.string.exception))
          .setText(e.getMessage())
          .setSmallIcon(android.R.drawable.stat_notify_error)
          .setTicker(getString(R.string.exception));
    }

    NotificationManager mgr=
        (NotificationManager) getSystemService(NOTIFICATION_SERVICE);

    mgr.notify(NOTIFY_ID, b.build());
}
```

The first thing we do in `raiseNotification()` is create a Builder object to help construct the Notification. On API Level 11 and higher, there is a `Notification.Builder` class that you can use. If you are supporting older devices, the Android Support package has a `NotificationCompat.Builder` backport of the same functionality, and that is what we are using in this particular project.

We can call methods on the Builder to configure the Notification that we want to display. Whether our download succeeded or failed, we use three methods on Builder:

## NOTIFICATIONS

---

- `setAutoCancel(true)` means that when the user slides open the notification drawer and taps on our entry, the Notification is automatically canceled and goes away
- `setDefaults(Notification.DEFAULT_ALL)` means that we want the device's standard notification tone, LED light flash, and vibration to occur when the Notification is displayed
- `setWhen(System.currentTimeMillis())` associates the current time with the Notification, which may be displayed in the notification drawer for this notification (depending on device configuration)

If we succeeded (the passed-in Exception is null), we further configure our Notification via more calls to the Builder:

- `setContentTitle()` and `setContentText()` supply the prose to display in the two lines of the notification drawer entry for our Notification
- `setSmallIcon()` indicates the icon to display in the status bar or system bar when the Notification is active (in this case, specifying one supplied by Android itself)
- `setTicker()` supplies some text to be displayed in the status bar or system bar for a few seconds right when the Notification is displayed, so users who happen to be looking at their device at that time will get more information at a glance about what just happened that is demanding their attention

In addition, `setContentIntent()` supplies a `PendingIntent` to be invoked when the notification drawer entry for our Notification is tapped. In our case, we create an `ACTION_VIEW` Intent for our File (using `Uri.fromFile()` to get a `Uri` pointing to our file on external storage) with the MIME type supplied from `DownloadFragment`. Hence, if the user taps on our notification drawer entry, we will attempt to bring up a PDF viewer on the downloaded PDF file – whether this will succeed or not will depend upon whether there is a PDF viewer installed on the device.

If, instead, we did have an Exception, we use the same methods on Builder (minus `setContentIntent()`) to configure the Notification, but using different text and icons.

To actually display the Notification, we need to get a `NotificationManager`, which is another system service. Calling `getSystemService()` and asking for the `NOTIFICATION_SERVICE` will give us our `NotificationManager`, albeit after a cast. Then, we can call `notify()` on the `NotificationManager`, supplying our Notification (from `build()` on the Builder) and a locally-unique integer (`NOTIFY_ID`, defined as a static data member on the service). That integer can later

## NOTIFICATIONS

---

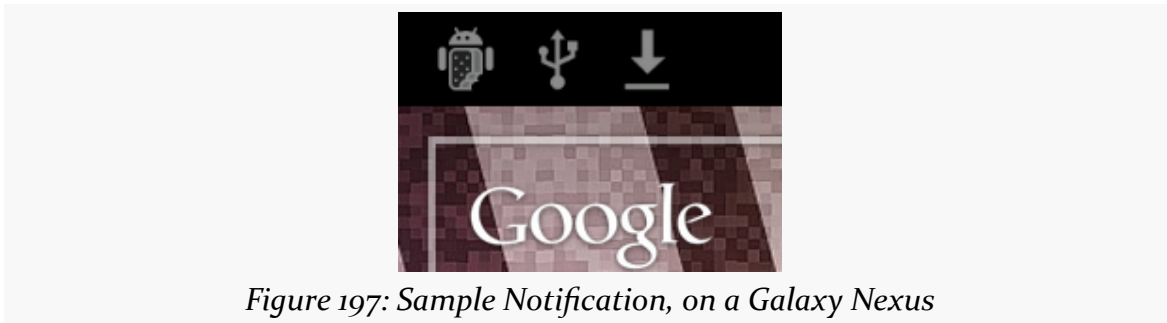
be used with a `cancel()` method to remove the Notification from the screen, even if the user has not canceled it themselves (e.g., via tapping on it with `setAutoCancel(true)`).

**NOTE:** You may see some samples using `getNotification()` with `NotificationBuilder` instead of `build()`. `getNotification()` was the original method, but it has since been deprecated in favor of `build()`.

Also, because we are using `setDefaults(Notification.DEFAULT_ALL)`, and since the default behavior for a Notification may involve vibrating the phone, we need to hold the `VIBRATE` permission in the manifest:

```
<uses-permission android:name="android.permission.VIBRATE"/>
```

Running this in a device or emulator will display the Notification upon completion of the download:



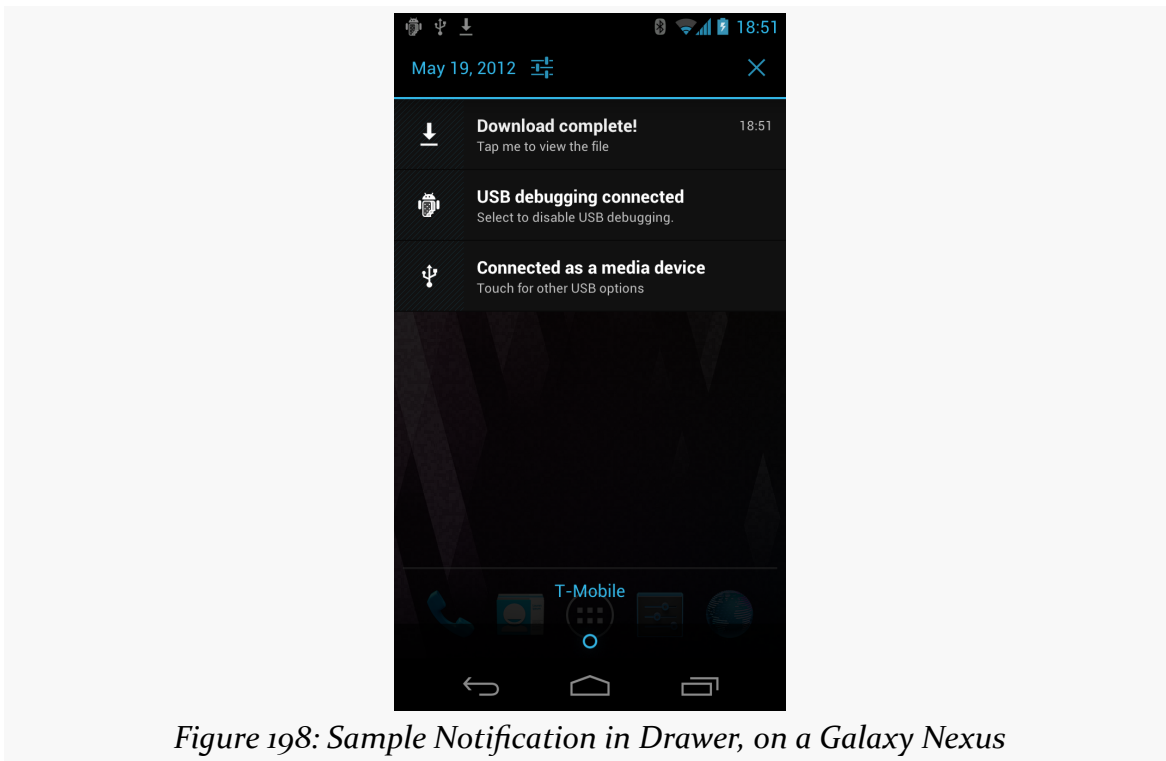
*Figure 197: Sample Notification, on a Galaxy Nexus*

Opening the notification drawer displays our Notification details:



## NOTIFICATIONS

---



*Figure 198: Sample Notification in Drawer, on a Galaxy Nexus*

Tapping on the drawer entry will try to start a PDF viewer, perhaps bringing up a chooser if there are multiple such viewers on the device. Also, tapping on the drawer entry will cancel the Notification and remove it from the screen.

## Notifications and Foreground Services

Notifications have another use: keeping select services around.

Services do not live forever. Android may terminate your application's process to free up memory in an emergency situation, or just because it seems to have been hanging around memory too long. Ideally, you design your services to deal with the fact that they may not run indefinitely.

However, some services will be missed by the user if they mysteriously vanish. For example, the default music player application that ships with Android uses a service for the actual music playback. That way, the user can listen to music while continuing to use their phone for other purposes. The service only stops when the user goes in and presses the stop button in the music player activity. If that service were to be shut down unexpectedly, the user might wonder what is wrong.

Services like this can declare themselves as being part of the “foreground”. This will cause their priority to rise and make them less likely to be bumped out of memory. The trade-off is that the service has to maintain a `Notification`, so the user knows that this service is claiming part of the foreground. And, ideally, that `Notification` provides an easy path back to some activity where the user can stop the service.

To do this, in `onCreate()` or `onStartCommand()` of your service (or wherever else in the service’s life it would make sense), call `startForeground()`. This takes a `Notification` and a locally-unique integer, just like the `notify()` method on `NotificationManager`. It causes the `Notification` to appear and moves the service into foreground priority. Later on, you can call `stopForeground()` to return to normal priority. So long as the `Notification` is visible, your process will have foreground priority and be far less likely to be terminated, even for low memory conditions.

## Seeking Some Order

By default, broadcasts are sent more or less in parallel. If there are ten `BroadcastReceiver` objects that will all qualify for an `Intent` via their `IntentFilter`, all ten will get the broadcast, in an indeterminate order, some possibly at the same time.

Sometimes, this is not what we want. We want broadcasts to be picked up serially, in a known sequence of possible receivers. That can be handled in Android via an ordered broadcast. This is particularly important for situations where we are using `AlarmManager` in the background, so we can update either the foreground activity or raise a `Notification` if we do not have an activity in the foreground.

## The Activity-Or-Notification Scenario

Let us suppose that you are writing an email app. In addition to an “inbox” activity, you have an `IntentService`, scheduled via `AlarmManager`, to go check for new email messages every so often. This means, when your service discovers and downloads new messages, there are two possibilities:

- The user has your inbox activity in the foreground, and that activity should update to reflect the fact that there are new messages
- The user does *not* have your inbox activity in the foreground, so you want to display a `Notification` to alert the user of the new messages and lead them back to the inbox

## NOTIFICATIONS

---

However, ideally, the service neither knows nor cares whether the inbox activity is in the foreground, exists in the process but is not in the foreground, or does not exist in the process (e.g., Android started a new process to handle this middle-of-the-night check for new email messages).

One way to handle this is via an ordered broadcast.

The recipe for the Activity-or-Notification pattern is:

1. Define an action string you will use when the event occurs that you want to go to the activity or notification (e.g., `com.commonware.java.packages.are.fun.EVENT`).
2. Dynamically register a `BroadcastReceiver` in your activity, with an `IntentFilter` set up for the aforementioned action string and with a positive priority (the default priority for a filter is 0). This receiver should then have the activity do whatever it needs to do to update the UI based on this event. The receiver should also call `abortBroadcast()` to prevent others from getting it. Be sure to register the receiver in `onStart()` or `onResume()` and unregister the receiver in the corresponding `onStop()` or `onPause()` method.
3. Register in your manifest a `BroadcastReceiver`, with an `<intent-filter>` set up for the aforementioned action string. This receiver should raise the `Notification`.
4. In your service (e.g., an `IntentService`), when the event occurs, call `sendOrderedBroadcast()`.

And that's it. Android takes care of the balance. If the activity is on-screen, its receiver will be registered, so it will get the event, process it, and cancel the broadcast. If the activity is not on-screen, its receiver will not be registered, so the event will go to the default handler, in the form of your manifest-registered `BroadcastReceiver`, which will raise the `Notification`.

For example, let's take a look at the [Notifications/Ordered](#) sample application.

In our `OrderedActivity`, in `onCreate()`, we set up `AlarmManager` to pass control to a service (`NoticeService`) every five seconds:

```
@Override
public void onCreate(Bundle savedInstanceState) {
    super.onCreate(savedInstanceState);
    setContentView(R.layout.main);
}
```

## NOTIFICATIONS

---

```
notice=(Button)findViewById(R.id.notice);

((NotificationManager)getSystemService(NOTIFICATION_SERVICE))
    .cancelAll();

mgr=(AlarmManager)getSystemService(Context.ALARM_SERVICE);

Intent i=new Intent(this, NoticeService.class);

pi=PendingIntent.getService(this, 0, i, 0);

cancelAlarm(null);

mgr.setRepeating(AlarmManager.ELAPSED_REALTIME_WAKEUP,
    SystemClock.elapsedRealtime()+1000,
    5000,
    pi);
}
```

We also rig up a button to cancel that alarm when pressed, via a `cancelAlarm()` method:

```
public void cancelAlarm(View v) {
    mgr.cancel(pi);
}
```

The `NoticeService`, when invoked by the `AlarmManager`, should theoretically do some work. In our case, doing work sounds too much like doing work, and we are lazy in this sample, so we skip straight to sending the ordered broadcast:

```
package com.commonware.android.ordered;

import android.app.IntentService;
import android.content.Intent;

public class NoticeService extends IntentService {
    public static final String BROADCAST=
        "com.commonware.android.ordered.NoticeService.BROADCAST";
    private static Intent broadcast=new Intent(BROADCAST);

    public NoticeService() {
        super("NoticeService");
    }

    @Override
    protected void onHandleIntent(Intent intent) {
        sendOrderedBroadcast(broadcast, null);
    }
}
```

## NOTIFICATIONS

---

OrderedActivity, in onResume(), registers a BroadcastReceiver to handle this broadcast, with a high-priority IntentFilter:

```
@Override
public void onResume() {
    super.onResume();

    IntentFilter filter=new IntentFilter(NoticeService.BROADCAST);

    filter.setPriority(2);
    registerReceiver(onNotice, filter);
}
```

We unregister that receiver in onPause():

```
@Override
public void onPause() {
    super.onPause();

    unregisterReceiver(onNotice);
}
```

The BroadcastReceiver itself updates the caption of our Button with the current date and time:

```
private BroadcastReceiver onNotice=new BroadcastReceiver() {
    public void onReceive(Context ctxt, Intent i) {
        notice.setText(new Date().toString());
        abortBroadcast();
    }
};
```

The BroadcastReceiver also aborts the broadcast, so no other receivers could get it.

Hence, if we start up the activity and let it run, our Button caption simply changes every five seconds:

## NOTIFICATIONS

---



Figure 199: The OrderedActivity, showing the time of the last alarm

But, what happens if we leave the activity, such as via BACK or HOME?

In that case, we also have a <receiver> element in our manifest, set up to listen for the same broadcast:

```
<?xml version="1.0" encoding="utf-8"?>
<manifest xmlns:android="http://schemas.android.com/apk/res/android"
  package="com.commonware.android.ordered"
  android:versionCode="1"
  android:versionName="1.0">

  <supports-screens
    android:largeScreens="true"
    android:normalScreens="true"
    android:smallScreens="false"/>

  <uses-sdk
    android:minSdkVersion="7"
    android:targetSdkVersion="11"/>
  <uses-permission android:name="android.permission.VIBRATE"/>

  <application
    android:icon="@drawable/ic_launcher"
    android:label="@string/app_name">
    <activity
```

## NOTIFICATIONS

---

```
    android:name="OrderedActivity"
    android:label="@string/app_name">
    <intent-filter>
        <action android:name="android.intent.action.MAIN" />

        <category android:name="android.intent.category.LAUNCHER" />
    </intent-filter>
</activity>

<service android:name="NoticeService" />

<receiver android:name=".NoticeReceiver">
    <intent-filter>
        <action
android:name="com.commonware.android.ordered.NoticeService.BROADCAST" />
    </intent-filter>
</receiver>
</application>

</manifest>
```

That is tied to a NoticeReceiver that simply displays a Notification:

```
package com.commonware.android.ordered;

import android.app.Notification;
import android.app.NotificationManager;
import android.app.PendingIntent;
import android.content.BroadcastReceiver;
import android.content.Context;
import android.content.Intent;
import android.support.v4.app.NotificationCompat;

public class NoticeReceiver extends BroadcastReceiver {
    private static final int NOTIFY_ME_ID=1337;

    @Override
    public void onReceive(Context ctxt, Intent intent) {
        NotificationManager mgr=
            (NotificationManager)ctxt.getSystemService(Context.NOTIFICATION_SERVICE);
        NotificationCompat.Builder b=new NotificationCompat.Builder(ctxt);
        PendingIntent pi=
            PendingIntent.getActivity(ctxt, 0,
                new Intent(ctxt,
                    OrderedActivity.class), 0);

        b.setAutoCancel(true).setDefaults(Notification.DEFAULT_ALL)
            .setWhen(System.currentTimeMillis())
            .setContentTitle(ctxt.getString(R.string.notify_title))
            .setContentText(ctxt.getString(R.string.notify_text))
            .setSmallIcon(android.R.drawable.stat_notify_chat)
            .setTicker(ctxt.getString(R.string.notify_ticker))
            .setContentIntent(pi);
    }
}
```

```
mgr.notify(NOTIFY_ME_ID, b.build());  
}  
}
```

So, if we leave the activity, our alarms are still going off, but we display a Notification instead of updating the Button caption. Our service is oblivious to whether the broadcast is handled by the activity, the manifest-registered BroadcastReceiver, or is totally ignored.

### Other Scenarios

You might use an ordered broadcast for plugins to your app. Several plugins might handle the broadcast, and which plugin handles which subset of your broadcasts is determined in large part by which plugins the user elected to install. So, you send an ordered broadcast and allow the plugins to use priorities to establish the “pecking order” and handle their particular broadcasts (aborting those they handle, letting the rest pass).

The SMS subsystem in Android uses ordered broadcasts, to allow replacement SMS clients to handle messages, replacing the built-in client. We will examine this in greater detail [later in this book](#).

## Big (and Rich) Notifications

Android 4.1 (a.k.a., Jelly Bean) introduced new Notification styles that automatically expand into a “big” area when they are the top Notification in the drawer. These expanded Notifications can display more text (or a larger thumbnail of an image), plus add some action buttons to allow the user to directly perform more actions straight from the Notification itself.

And while these new Notification styles are only available on API Level 16 and higher, a familiar face has created a compatibility layer so our code can request the larger styles and still work on older devices.

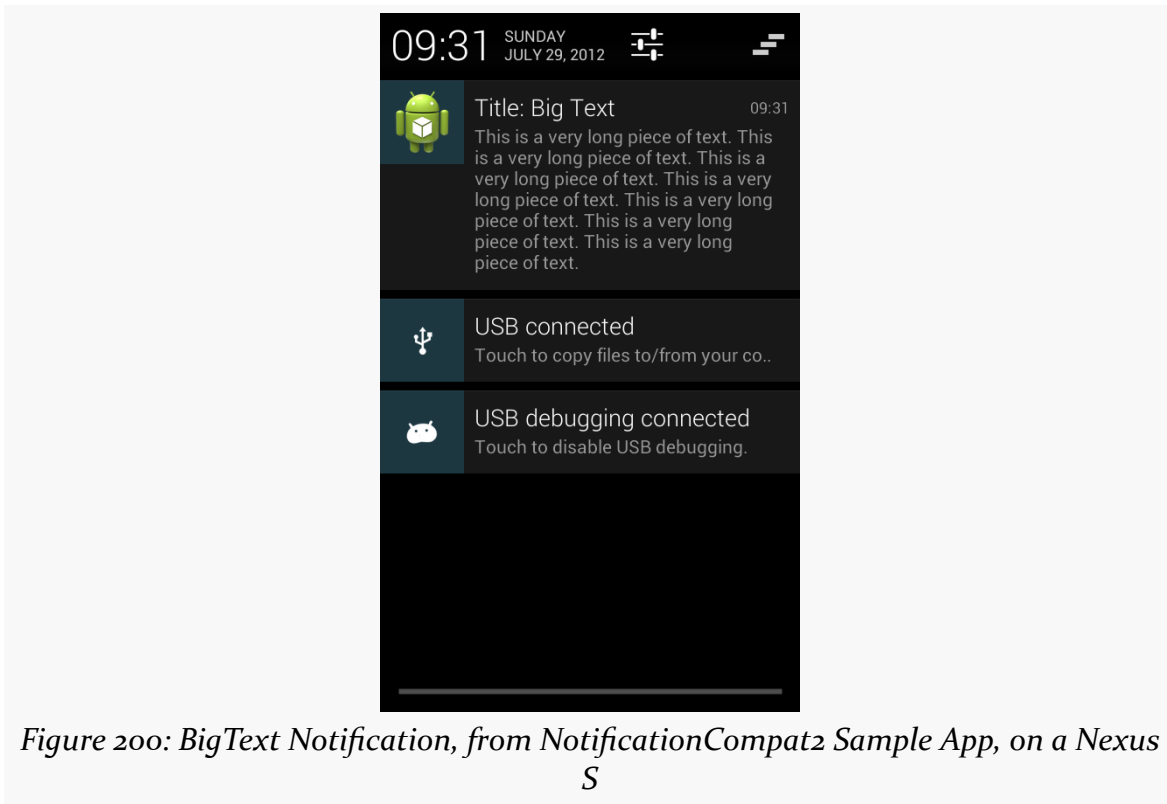
### The Styles

There are three main styles supplied for expanded Notifications. There is the BigText style:



## NOTIFICATIONS

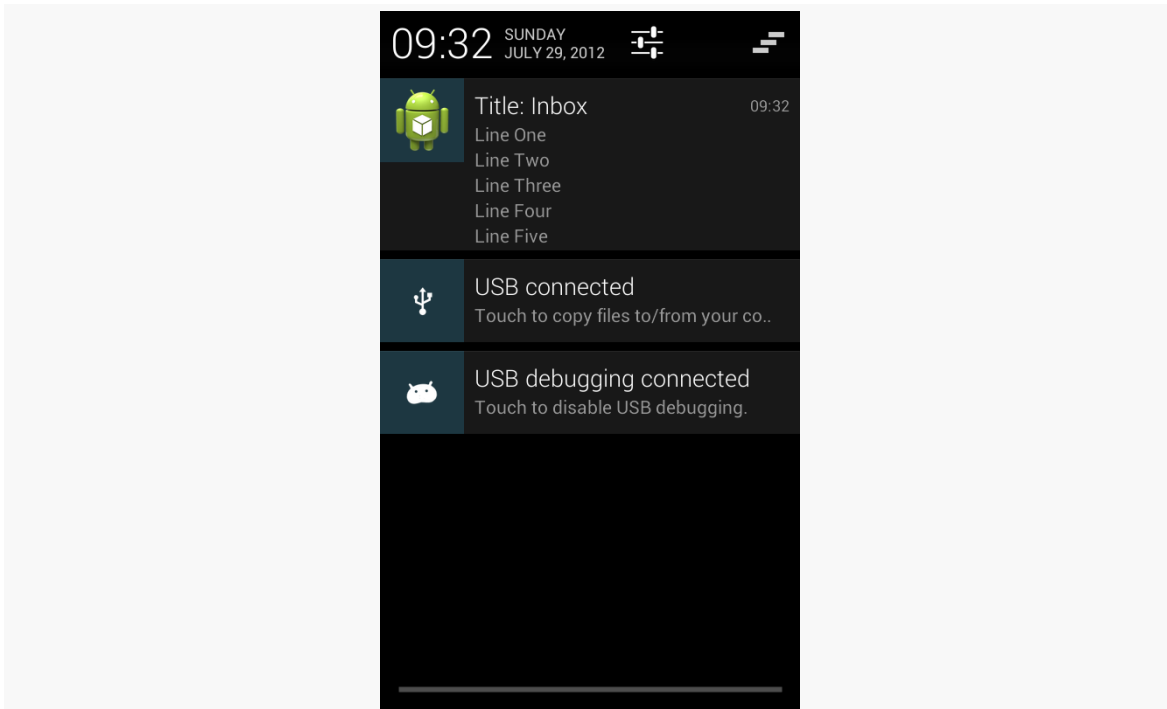
---



We also have the Inbox style, which is the same basic concept but designed, for several discrete lines of text:

## NOTIFICATIONS

---

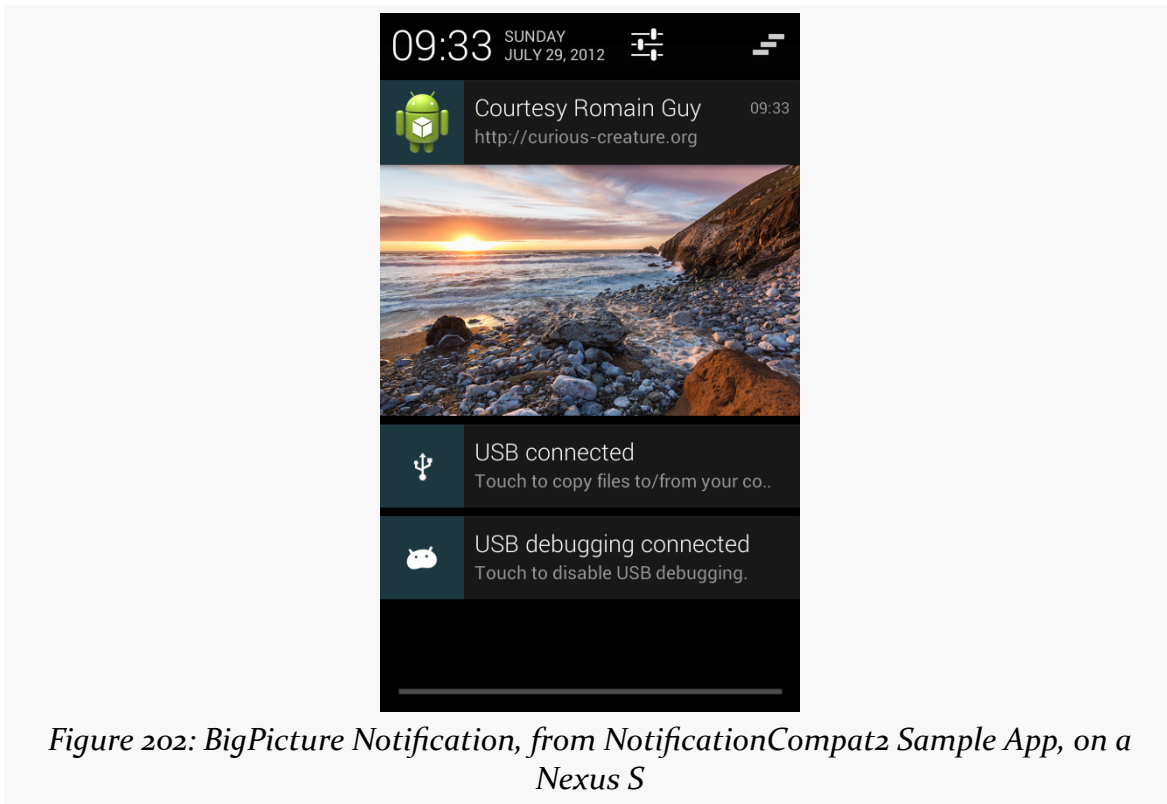


*Figure 201: Inbox Notification, from NotificationCompat2 Sample App, on a Nexus S*

And, we have the BigPicture style, ideal for a photo, album cover, or the like:

## NOTIFICATIONS

---



*Figure 202: BigPicture Notification, from NotificationCompat2 Sample App, on a Nexus S*

(as noted in the screenshot, the photo is courtesy of Romain Guy, an engineer on the core Android team and photography buff)

### The Builders

`Notification.Builder`, from the Android SDK, has been enhanced to support these new styles. Specifically:

- There is an `addAction()` method on the Builder class to define the action buttons, in terms of icon, caption, and `PendingIntent` that should be executed when the button is clicked
- There are style-specific builders, such as `Notification.InboxStyle`, that take a `Notification.Builder` and define the alternative expanded definition to be used when the Notification is at the top

The v10 version of the Android Support package has a version of `NotificationCompat` that supports these new APIs. Note, though, that older versions of the package do not. You will either need to use a v10 or higher version of

the package or use [Jake Wharton's NotificationCompat2](#), which contains the missing functionality.

### The Sample

To see the new Jelly Bean capabilities in action, take a peek at the [Notifications/BigNotify](#) sample application. This application consists of a single activity (MainActivity) that will raise a Notification and finish(), using @style/Theme.NoDisplay to suppress the activity's own UI. Hence, the result of running the app is to display the Notification and do nothing else. While silly, it minimizes the amount of ancillary code involved in the project.

In the libs/ directory, we have a copy of the v10 version of the Android Support package's android-support-v4.jar.

The process of displaying an expanded Notification is to first create the basic Notification, containing what you want to display for any non-expanded circumstance:

- Older devices that cannot display expanded Notifications, or
- Newer devices where the Notification is not the top-most entry in the notification drawer, and therefore appears in the classic non-expanded form

Hence, in onCreate(), after getting our hands on a NotificationManager, we use NotificationCompat.Builder to create a regular Notification, wrapped in a private buildNormal() method:

```
private NotificationCompat.Builder buildNormal() {
    NotificationCompat.Builder b=new NotificationCompat.Builder(this);

    b.setAutoCancel(true)
    .setDefaults(Notification.DEFAULT_ALL)
    .setWhen(System.currentTimeMillis())
    .setContentTitle(getString(R.string.download_complete))
    .setContentText(getString(R.string.fun))
    .setContentIntent(buildPendingIntent(Settings.ACTION_SECURITY_SETTINGS))
    .setSmallIcon(android.R.drawable.stat_sys_download_done)
    .setTicker(getString(R.string.download_complete))
    .setPriority(Notification.PRIORITY_HIGH)
    .addAction(android.R.drawable.ic_media_play,
                getString(R.string.play),
                buildPendingIntent(Settings.ACTION_SETTINGS));

    return(b);
}
```

## NOTIFICATIONS

---

Most of what `buildNormal()` does is the same sort of stuff we saw with `NotificationCompat.Builder` earlier in this chapter. There are two things, though, that are new:

1. We call `setPriority()` to set the priority of the Notification to `PRIORITY_HIGH`. This means that this Notification *may* be displayed higher in the notification drawer than it might ordinarily appear.
2. We call `addAction()` to add an action button to the Notification, to be shown in the expanded form. We are able to supply an icon, caption, and `PendingIntent`, the latter created by a `buildPendingIntent()` method that wraps our desired Intent action string (here, `Settings.ACTION_SETTINGS`) in an Intent:

```
private PendingIntent buildPendingIntent(String action) {
    Intent i=new Intent(action);

    return(PendingIntent.getActivity(this, 0, i, 0));
}
```

Ordinarily, we might use this Builder directly, to raise the Notification we described. And, if we just wanted the action button to appear and nothing else new in the expanded form, we could do just that. But in our case, we also want to change the look of the expanded widget to a new style, `InboxStyle`. To do that, we need to wrap our Builder in a `NotificationCompat.InboxStyle` builder:

```
@Override
public void onCreate(Bundle savedInstanceState) {
    super.onCreate(savedInstanceState);

    NotificationManager mgr=
        (NotificationManager) getSystemService(NOTIFICATION_SERVICE);
    NotificationCompat.Builder normal=buildNormal();
    NotificationCompat.InboxStyle big=
        new NotificationCompat.InboxStyle(normal);

    mgr.notify(NOTIFY_ID,
        big.setSummaryText(getString(R.string.summary))
            .addLine(getString(R.string.entry))
            .addLine(getString(R.string.another_entry))
            .addLine(getString(R.string.third_entry))
            .addLine(getString(R.string.yet_another_entry))
            .addLine(getString(R.string.low)).build());

    finish();
}
```

## NOTIFICATIONS

---

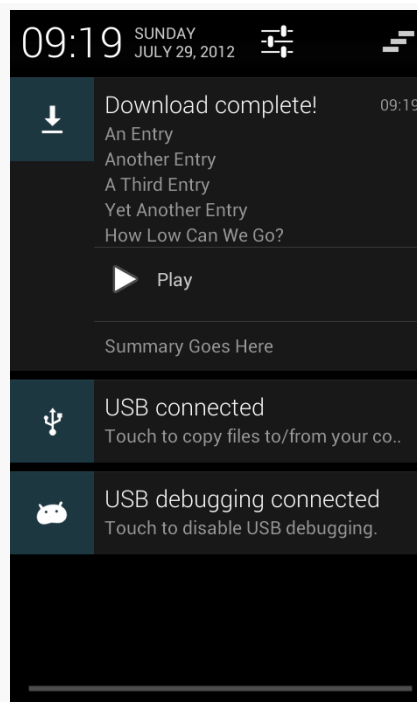
Each of these “big” builders has a set of methods that are unique to that type of builder to configure the look beyond what a standard Notification might have. Specifically, in this case, we call:

- `setSummaryText()`, to provide “the first line of text after the detail section in the big form of the template”, in the words of the JavaDocs, though this does not necessarily mean what you think it does
- `addLine()`, to append several lines of text to appear in the Notification

It is the Notification created by our `NotificationCompat.InboxStyle` builder that we use with the call to `notify()` on `NotificationManager`.

### The Results

If we run our app, we get this:



*Figure 203: Expanded Notification in Drawer, on a Nexus S*

From top to bottom, we have:

- Our content text
- Our appended lines of text

## NOTIFICATIONS

---

- Our action button
- Our summary text

Note that this is the appearance when we are in expanded mode, at the top of the notification drawer. If our Notification is not at the top, or if it is displayed on a pre-Jelly Bean device, the appearance is the normal style, as defined by our `buildNormal()` method, though on Jelly Bean devices the user can use a two-finger downward swipe gesture to expand the un-expanded Notification.

### The Target Requirement

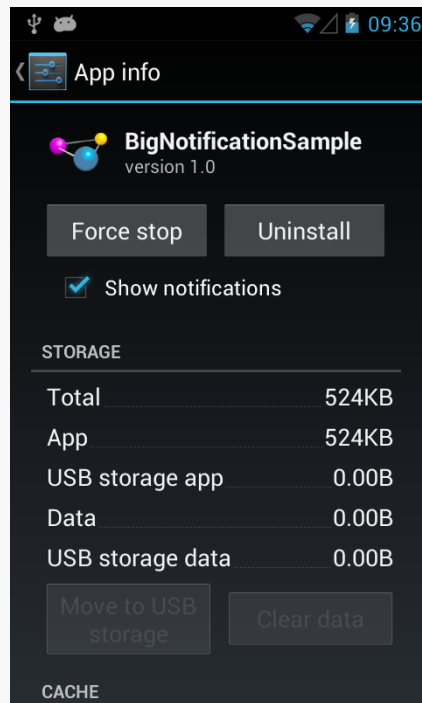
Note that to use action buttons successfully, you need to have your `android:targetSdkVersion` set to 11 or higher. Technically, they will work with lower values, but the contents of the button will be rendered incorrectly, with a gray-on-gray color scheme that makes the buttons all but unreadable. Using 11 or higher will cause the buttons to be rendered with an appropriate color scheme.

### Disabled Notifications

Because apps have the ability to display larger-than-normal Notifications, plus force them towards the top of the list via priority levels, Android has given users the ability to disable Notifications on a per-app basis. Users visiting an app's page in Settings will see a "Show notifications" checkbox:

## NOTIFICATIONS

---



*Figure 204: Show Notifications Checkbox, on a Nexus S*

If the user unchecks the checkbox and agrees on the resulting confirmation dialog, your requests to raise a Notification will be largely ignored. An error message will appear in LogCat (“Suppressing notification from package ... by user request”), but no exception will be raised. Further, there does not appear to be an API for you to determine if the notification will actually be displayed.

Also note that, at least through Android 4.2, if the user blocks notifications, it also blocks Toast requests from your app.





# Tutorial #18 - Notifying the User

---

In the last tutorial, we added automatic updating. However, the user will not know that the book was updated in the background, unless they open the book and see an update. It would be nice to let the user know that an update succeeded, if EmPubLiteActivity is not in the foreground, and a Notification is a likely solution.

This is a continuation of the work we did in [the previous tutorial](#).

You can find [the results of the previous tutorial](#) and [the results of this tutorial](#) in [the book's GitHub repository](#).

Note that if you are importing the previous code to begin work here, you will also need the [copy of ActionBarSherlock in this book's GitHub repository](#), and to make sure that your imported EmPubLite project references the ActionBarSherlock project as a library.

## Step #1: Adding the InstallReceiver

The reason we used an ordered broadcast (`sendOrderedBroadcast()`) back in Tutorial #16 for broadcasting the install-completed event is to support this tutorial. Here, we are using the ordered broadcast event pattern:

1. Implement a high-priority receiver in the foreground activity, which handles the event and aborts the broadcast
2. Implement a standard-priority receiver that is registered via the manifest, and have it handle the event for cases where the activity is not in the foreground

## TUTORIAL #18 - NOTIFYING THE USER

---

So, we need another `BroadcastReceiver` — let's create one named `InstallReceiver` for this role. We will also take advantage of the fact that this broadcast is only needed internally within our app, so we will mark this `BroadcastReceiver` as non-exported in the manifest, so no other code will be able to trigger it.

If you wish to make this change using Eclipse's wizards and tools, follow the instructions in the "Eclipse" section below. Otherwise, follow the instructions in the "Outside of Eclipse" section (appears after the "Eclipse" section).

### Eclipse

Right click over the `com.commonware.empublite` package in the `src/` folder of your project, and choose `New > Class` from the context menu. Fill in `InstallReceiver` in the "Name" field. Click the "Browse..." button next to the "Superclass" field and find `BroadcastReceiver` to set as the superclass. Then, click "Finish" on the new-class dialog to create the `InstallReceiver` class.

You will also need to add a new receiver node to the list of nodes in the Application sub-tab of `AndroidManifest.xml`, pointing to `InstallReceiver`, following the same approach that we used for other receivers in this application. However, in addition to choosing `InstallReceiver` as the component name, also switch the "Exported" drop-down to `false`.

However, we also must add an `<intent-filter>` to the `<receiver>` element, identifying the broadcast which we wish to monitor. To do that:

- Click on the Receiver element associated with `InstallReceiver` in the list of "Application Nodes"
- Click the "Add..." button next to the list of "Application Nodes" and choose "Intent Filter" from the list
- With the "Intent Filter" highlighted in the "Application Nodes" tree, click "Add..." again, this time choosing "Action" from the list
- In the details area on the right, type in `com.commonware.empublite.action.UPDATE_READY`, since this is a custom action and therefore will not appear in the Eclipse drop-down list

### Outside of Eclipse

Create an empty `src/com/commonware/empublite/InstallReceiver.java` source file; we will fill in the source code for it in the next step.

---

## TUTORIAL #18 - NOTIFYING THE USER

---

Also, add the following <receiver> element as a child of the <application> element in AndroidManifest.xml:

```
<receiver
    android:name="InstallReceiver"
    android:exported="false">
    <intent-filter>
        <action android:name="com.commonware.empublite.action.UPDATE_READY"/>
    </intent-filter>
</receiver>
```

## Step #2: Completing the InstallReceiver

First, create two new string resources:

- R.string.update\_desc, with a value of Click here to open the updated book!
- R.string.update\_complete, with a value of EmPub Lite Updated!

Then, modify the InstallReceiver implementation from the original stub to this:

```
package com.commonware.empublite;

import android.app.NotificationManager;
import android.app.PendingIntent;
import android.content.BroadcastReceiver;
import android.content.Context;
import android.content.Intent;
import android.support.v4.app.NotificationCompat;

public class InstallReceiver extends BroadcastReceiver {
    private static final int NOTIFY_ID=1337;

    @Override
    public void onReceive(Context ctxt, Intent i) {
        NotificationCompat.Builder builder=
            new NotificationCompat.Builder(ctxt);
        Intent toLaunch=new Intent(ctxt, EmPubLiteActivity.class);
        PendingIntent pi=PendingIntent.getActivity(ctxt, 0, toLaunch, 0);

        builder.setAutoCancel(true).setContentIntent(pi)
            .setTitle(ctxt.getString(R.string.update_complete))
            .setText(ctxt.getString(R.string.update_desc))
            .setSmallIcon(android.R.drawable.stat_sys_download_done)
            .setTicker(ctxt.getString(R.string.update_complete))
            .setWhen(System.currentTimeMillis());

        NotificationManager mgr=
```

## TUTORIAL #18 - NOTIFYING THE USER

---

```
((NotificationManager)ctxt.getSystemService(Context.NOTIFICATION_SERVICE));  
    mgr.notify(NOTIFY_ID, builder.build());  
}
```

Here, we:

- Create a `NotificationCompat.Builder`
- Create an activity `PendingIntent`, pointing at `EmPubLiteActivity`
- Configure the Notification via the Builder
- Raise the Notification once configured

To test this, repeat the test from [Step #5 of the previous tutorial](#). You should see the Notification appear once the update has completed. Sliding open the notification drawer and tapping on the notification should bring up the book for reading.

## In Our Next Episode...

... we will [move some fragments into a sidebar](#) on large-screen devices, like tablets.

# **Large-Screen Strategies and Tactics**

---

So far, we have been generally ignoring screen size. With the vast majority of Android devices being in a fairly narrow range of sizes (3" to just under 5"), ignoring size while learning is not a bad approach. However, when it comes time to create a production app, you are going to want to strongly consider how you are going to handle other sizes, mostly larger ones (a.k.a., tablets).

## **Objective: Maximum Gain, Minimum Pain**

What you want is to be able to provide a high-quality user experience without breaking your development budget — time *and* money — in the process.

An app designed around a phone, by default, may look fairly lousy on a tablet. That is because Android is simply going to try to stretch your layouts and such to fill the available space. While that will work, technically, the results may be unpleasant, or at least ineffective. If we have the additional room, it would be nice to allow the user to do something with that room.

At the same time, though, you do not have an infinite amount of time to be dealing with all of this. After all, there are a variety of tablet sizes. While ~7" and ~10" screens are the most common, there are certainly others that are reasonably popular (e.g., the Galaxy Note is ~5" and from a design standpoint tends to be thought of as a tablet, even though it has telephony capability).

## **The Fragment Strategy**

Some apps will use the additional space of a large screen directly. For example, a painting app would use that space mostly to provide a larger drawing canvas upon

## LARGE-SCREEN STRATEGIES AND TACTICS

---

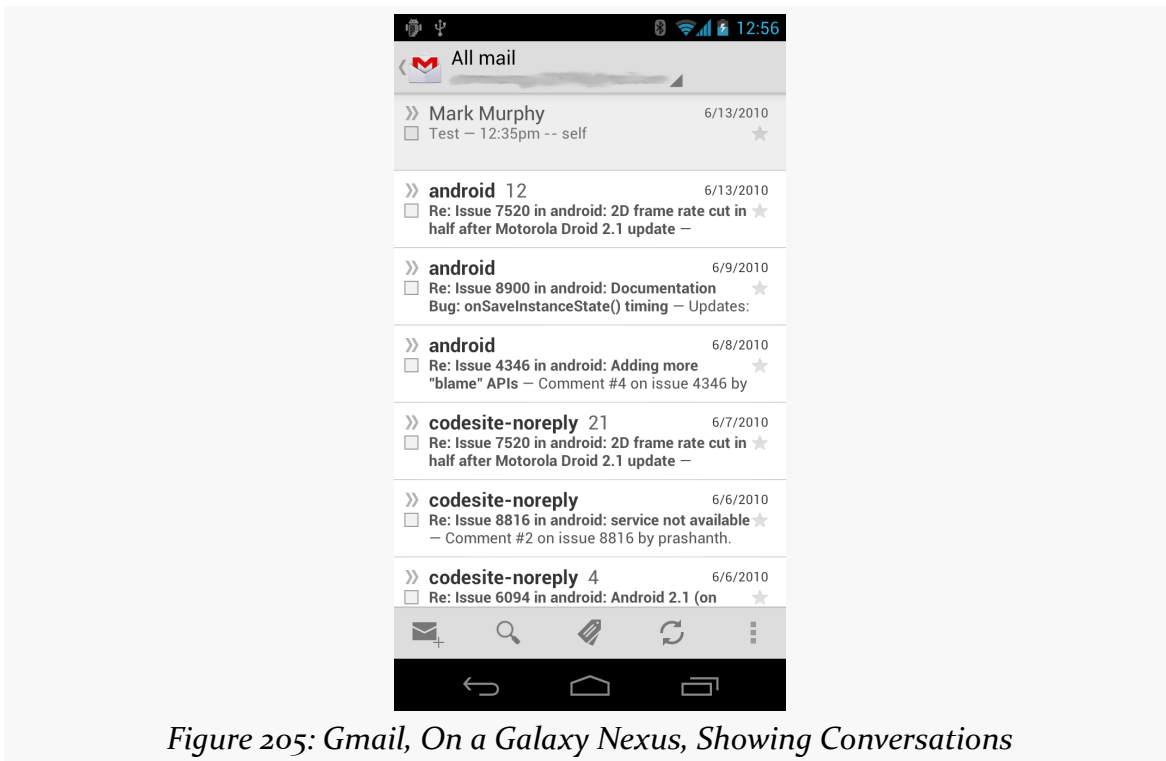
which the user can attempt to become the next Rembrandt, Picasso, or Pollock. The app might elect to make more tools available directly on the screen as well, versus requiring some sort of pop-up to appear to allow the user to change brush styles, choose a different color, and so forth.

However, this can be a lot of work.

Some apps can make a simplifying assumption: the tablet UI is really a bunch of phone-sized layouts, stitched together. For example, if you take a 10" tablet in landscape, it is about the same size as two or three phones side-by-side. Hence, one could imagine taking the smarts out of a few activities and having them be adjacent to one another on a tablet, versus having to be visible only one at a time as they are on phones.

For example, consider Gmail.

On a phone, you see conversations in a particular label on one screen:

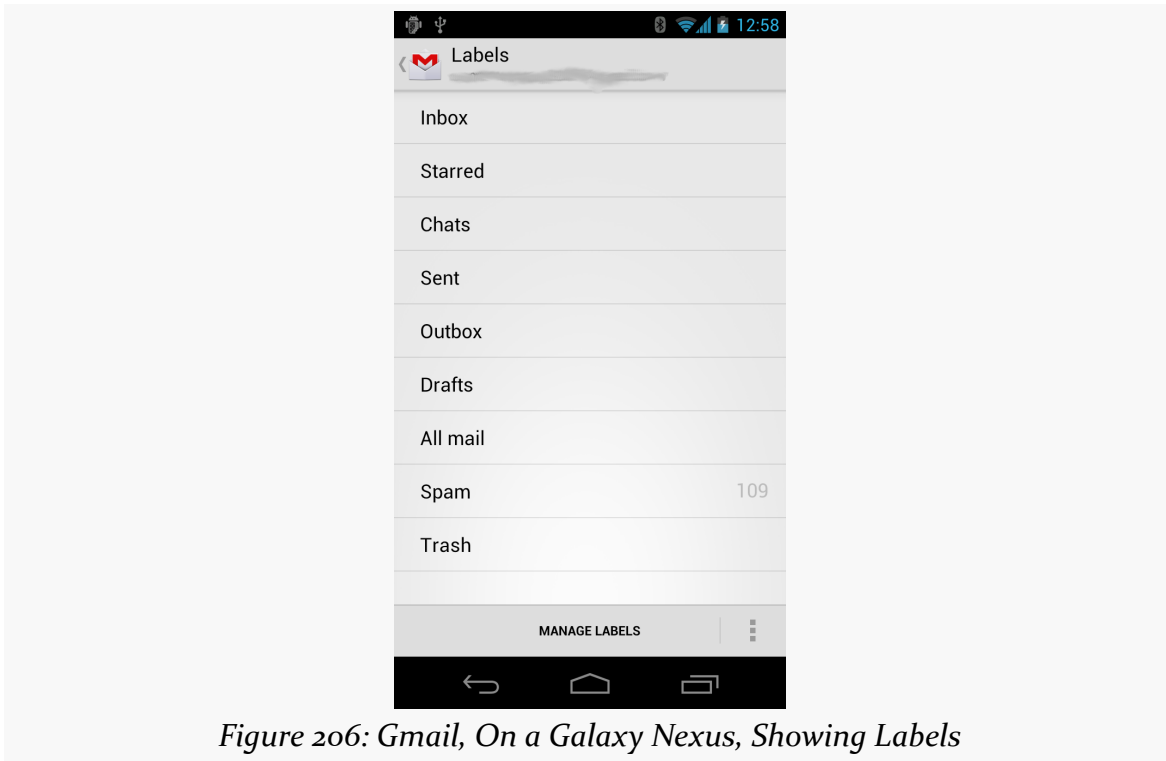


*Figure 205: Gmail, On a Galaxy Nexus, Showing Conversations*

... and the list of labels on another screen:

## LARGE-SCREEN STRATEGIES AND TACTICS

---



*Figure 206: Gmail, On a Galaxy Nexus, Showing Labels*

... and the list of messages in some selected conversation in a third screen:



## LARGE-SCREEN STRATEGIES AND TACTICS

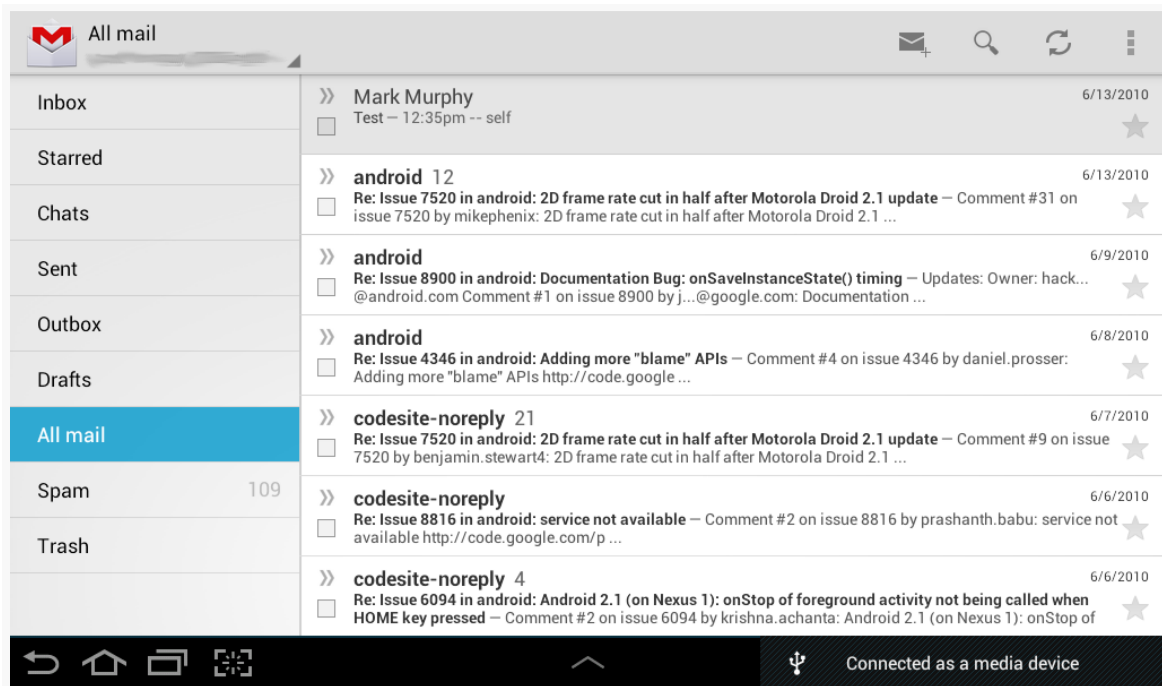
---



*Figure 207: Gmail, On a Galaxy Nexus, Showing Messages*

Whereas on a 7" tablet, you see the list of labels and the conversations in a selected label at the same time:

## LARGE-SCREEN STRATEGIES AND TACTICS



*Figure 208: Gmail, On a Galaxy Tab 2, Showing Labels and Conversations*

On that 7" tablet, tapping on a specific conversation brings up the list of messages for that conversation in a new screen. But, on a 10" tablet, tapping on a specific conversation shows it, plus the list of conversations, side-by-side:

## LARGE-SCREEN STRATEGIES AND TACTICS

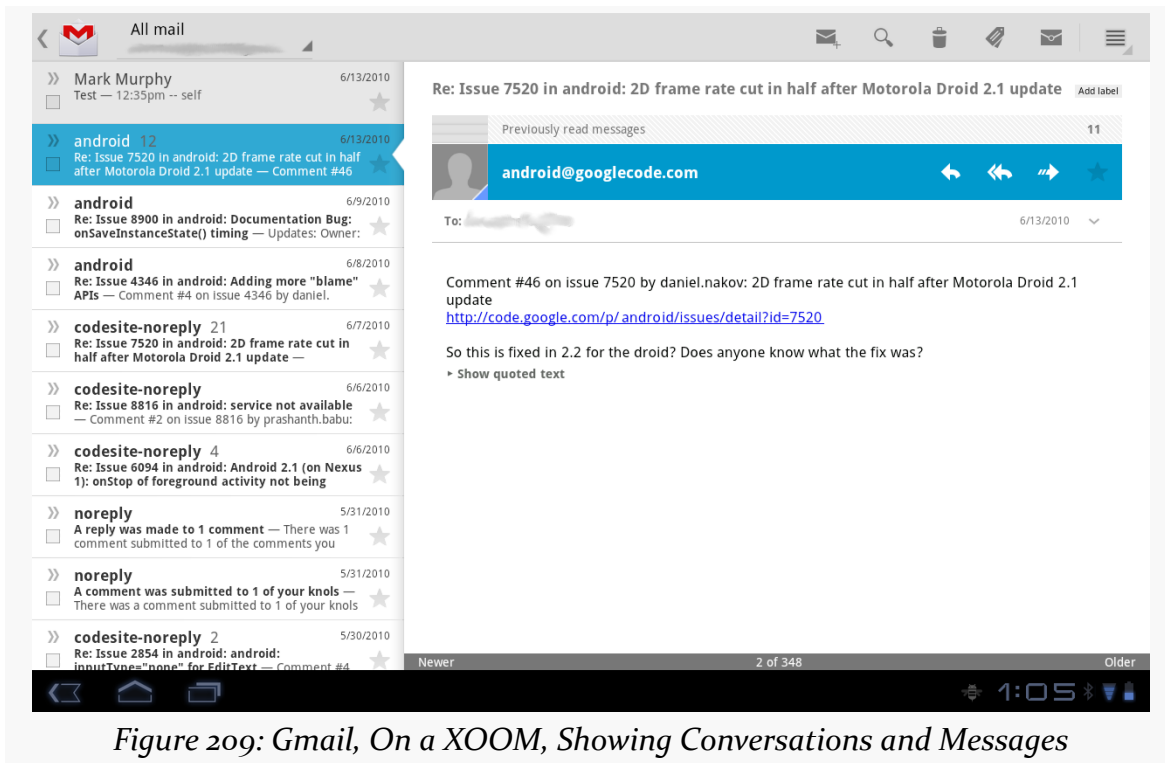


Figure 209: Gmail, On a XOOM, Showing Conversations and Messages

Yet all of that was done with one app with very little redundant logic, by means of fragments.

The list-of-labels, list-of-conversations, and list-of-messages bits of the UI were implemented as fragments. On a smaller screen (e.g., a phone), each one is displayed by an individual activity. Yet, on a larger screen (e.g., a tablet), more than one fragment is displayed by a single activity. In fact — though it will not be apparent from the static screenshots — on the 10” tablet, the activity showed *all three fragments*, using animated effects to slide the list of labels off-screen and the list of conversations over to the left slot when the user taps on a conversation to show the messages.

The vision, therefore, is to organize your UI into fragments, then choose which fragments to show in which circumstances based on available screen space:

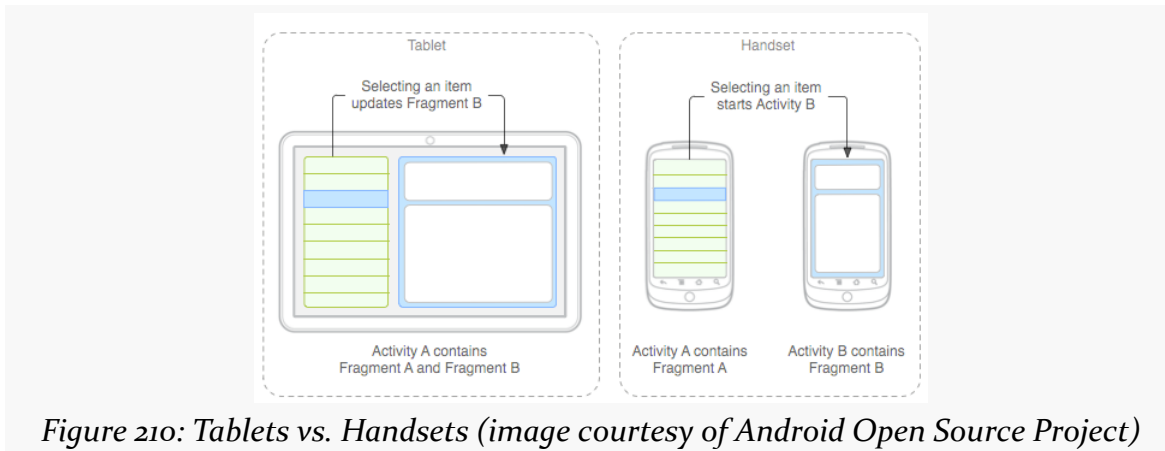


Figure 210: Tablets vs. Handsets (image courtesy of Android Open Source Project)

### Changing Layout

One solution is to say that you have the same fragments for all devices and all configurations, but that the sizing and positioning of those fragments varies. This is accomplished by using different layouts for the activity, ones that provide the sizing and positioning rules for the fragments.

So far, most of our fragment examples have been focused on activities with a single fragment, like you might use on smaller screens (e.g., phones). However, activities can most certainly have more than one fragment, though you will need to provide the “slots” into which to plug those fragments.

For example, you could have the following in `res/layout-large-land/main.xml`:

```
<?xml version="1.0" encoding="utf-8"?>
<LinearLayout
  xmlns:android="http://schemas.android.com/apk/res/android"
  android:orientation="horizontal"
  android:layout_width="fill_parent"
  android:layout_height="fill_parent">
  <FrameLayout
    android:id="@+id/countries"
    android:layout_weight="30"
    android:layout_width="0px"
    android:layout_height="fill_parent"
  />
  <FrameLayout
    android:id="@+id/details"
    android:layout_weight="70"
    android:layout_width="0px"
    android:layout_height="fill_parent"
  />
</LinearLayout>
```

## LARGE-SCREEN STRATEGIES AND TACTICS

---

Here we have a horizontal `LinearLayout` holding a pair of `FrameLayout` containers. Each of those `FrameLayout` containers will be a slot to load in a fragment, using code like:

```
getSupportFragmentManager().beginTransaction()  
    .add(R.id.countries, someFragmentHere)  
    .commit();
```

In principle, you could have a `res/layout-large/main.xml` that holds both of the same `FrameLayout` containers, but just in a vertical `LinearLayout`:

```
<?xml version="1.0" encoding="utf-8"?>  
<LinearLayout  
    xmlns:android="http://schemas.android.com/apk/res/android"  
    android:orientation="vertical"  
    android:layout_width="fill_parent"  
    android:layout_height="fill_parent">  
    <FrameLayout  
        android:id="@+id/countries"  
        android:layout_weight="30"  
        android:layout_width="0px"  
        android:layout_height="fill_parent"  
    />  
    <FrameLayout  
        android:id="@+id/details"  
        android:layout_weight="70"  
        android:layout_width="0px"  
        android:layout_height="fill_parent"  
    />  
</LinearLayout>
```

As the user rotates the device, the fragments will go in their appropriate slots.

### Changing Fragment Mix

However, for larger changes in screen size, you will probably need to have larger changes in your fragments. The most common pattern is to have fewer fragments on-screen for an activity on a smaller-screen device (e.g., one fragment at a time on a phone) and more fragments on-screen for an activity on a larger-screen device (e.g., two fragments at a time on a tablet).

So, for example, as the counterpart to the `res/layout-large-land/main.xml` shown in the previous section, you might have a `res/layout/main.xml` that looks like this:

```
<?xml version="1.0" encoding="utf-8"?>  
<FrameLayout xmlns:android="http://schemas.android.com/apk/res/android"  
    android:id="@+id/countries"
```

```
android:layout_width="fill_parent"  
android:layout_height="fill_parent"  
</>
```

This provides a single slot, `R.id.countries`, for a fragment, one that fills the screen. For a larger-screen device, held in landscape, you would use the two-fragment layout; for anything else (e.g., tablet in portrait, or phone in any orientation), you would use the one-fragment layout.

Of course, the content that belongs in the second fragment would have to show up *somewhere*, typically in a separate layout managed by a separate activity.

Sometimes, when you add another fragment for a large screen, you only want it to be there some of the time. For example, a digital book reader (like the one we are building in the tutorials) might normally take up the full screen with the reading fragment, but might display a sidebar fragment based upon an action bar item click or the like. If you would like the BACK button to reverse your `FragmentManager` that added the second fragment — so pressing BACK removes that fragment and returns you to the single-fragment setup — you can add `addToBackStack()` as part of your `FragmentManager` construction:

```
getSupportFragmentManager().beginTransaction()  
    .addToBackStack(null)  
    .replace(R.id.sidebar, f)  
    .commit();
```

We will see this in [the next tutorial](#).

## The Role of the Activity

So, what is the activity doing?

First, the activity is the one loading the overall layout, the one indicating which fragments should be loaded (e.g., the samples shown above). The activity is responsible for populating those “slots” with the appropriate fragments. It can determine which fragments to create based on which slots exist, so it would only try to create a fragment to go in `R.id.details` if there actually is an `R.id.details` slot to use.

Next, the activity is responsible for handling any events that are triggered by UI work in a fragment (e.g., user clicking on a `ListView` item), whose results should impact other fragments (e.g., displaying details of the clicked-upon `ListView` item). The activity knows which fragments exist at the present time. So, the activity can

either call some method on the second fragment if it exists, or it can call `startActivity()` to pass control to another activity that will be responsible for the second fragment if it does not exist in the current activity.

Finally, the activity is generally responsible for any model data that spans multiple fragments. Whether that model data is held in a “model fragment” (as outlined [in the chapter on fragments](#)) or somewhere else is up to you.

## Fragment Example: The List-and-Detail Pattern

This will make a bit more sense as we work through another example, this time focused on a common pattern: a list of something, where clicking on the list brings up details on the item that was clicked upon. On a larger-screen device, in landscape, both pieces are typically displayed at the same time, side-by-side. On smaller-screen devices, and sometimes even on larger-screen devices in portrait, only the list is initially visible — tapping on a list item brings up some other activity to display the details.

### Describing the App

The sample app for this section is [LargeScreen/EU4You](#). This app has a list of member nations of the European Union (EU). Tapping on a member nation will display the mobile Wikipedia page for that nation in a `WebView` widget.

The data model — such as it is and what there is of it — consists of a `Country` class which holds onto the country name (as a string resource ID), flag (as a drawable resource ID), and mobile Wikipedia URL (as another string resource ID):

```
Country(int name, int flag, int url) {  
    this.name=name;  
    this.flag=flag;  
    this.url=url;  
}
```

The `Country` class has a static `ArrayList` of `Country` objects representing the whole of the EU, initialized in a static initialization block:

```
static ArrayList<Country> EU=new ArrayList<Country>();  
  
static {  
    EU.add(new Country(R.string.austria, R.drawable.austria,  
        R.string.austria_url));  
    EU.add(new Country(R.string.belgium, R.drawable.belgium,
```

## LARGE-SCREEN STRATEGIES AND TACTICS

---

```
        R.string.belgium_url));
EU.add(new Country(R.string.bulgaria, R.drawable.bulgaria,
        R.string.bulgaria_url));
EU.add(new Country(R.string.cyprus, R.drawable.cyprus,
        R.string.cyprus_url));
EU.add(new Country(R.string.czech_republic,
        R.drawable.czech_republic,
        R.string.czech_republic_url));
EU.add(new Country(R.string.denmark, R.drawable.denmark,
        R.string.denmark_url));
EU.add(new Country(R.string.estonia, R.drawable.estonia,
        R.string.estonia_url));
EU.add(new Country(R.string.finland, R.drawable.finland,
        R.string.finland_url));
EU.add(new Country(R.string.france, R.drawable.france,
        R.string.france_url));
EU.add(new Country(R.string.germany, R.drawable.germany,
        R.string.germany_url));
EU.add(new Country(R.string.greece, R.drawable.greece,
        R.string.greece_url));
EU.add(new Country(R.string.hungary, R.drawable.hungary,
        R.string.hungary_url));
EU.add(new Country(R.string.ireland, R.drawable.ireland,
        R.string.ireland_url));
EU.add(new Country(R.string.italy, R.drawable.italy,
        R.string.italy_url));
EU.add(new Country(R.string.latvia, R.drawable.latvia,
        R.string.latvia_url));
EU.add(new Country(R.string.lithuania, R.drawable.lithuania,
        R.string.lithuania_url));
EU.add(new Country(R.string.luxembourg, R.drawable.luxembourg,
        R.string.luxembourg_url));
EU.add(new Country(R.string.malta, R.drawable.malta,
        R.string.malta_url));
EU.add(new Country(R.string.netherlands, R.drawable.netherlands,
        R.string.netherlands_url));
EU.add(new Country(R.string.poland, R.drawable.poland,
        R.string.poland_url));
EU.add(new Country(R.string.portugal, R.drawable.portugal,
        R.string.portugal_url));
EU.add(new Country(R.string.romania, R.drawable.romania,
        R.string.romania_url));
EU.add(new Country(R.string.slovakia, R.drawable.slovakia,
        R.string.slovakia_url));
EU.add(new Country(R.string.slovenia, R.drawable.slovenia,
        R.string.slovenia_url));
EU.add(new Country(R.string.spain, R.drawable.spain,
        R.string.spain_url));
EU.add(new Country(R.string.sweden, R.drawable.sweden,
        R.string.sweden_url));
EU.add(new Country(R.string.united_kingdom,
        R.drawable.united_kingdom,
        R.string.united_kingdom_url));
}
```



### CountriesFragment

The fragment responsible for rendering the list of EU nations is `CountriesFragment`. It is a `SherlockListFragment`, using a `CountryAdapter` to populate the list:

```
class CountryAdapter extends ArrayAdapter<Country> {
    CountryAdapter() {
        super(getActivity(), R.layout.row, R.id.name, Country.EU);
    }

    @Override
    public View getView(int position, View convertView, ViewGroup parent) {
        CountryViewHolder wrapper=null;

        if (convertView == null) {
            convertView=
                LayoutInflater.from(getActivity()).inflate(R.layout.row,
                                                            null);

            wrapper=new CountryViewHolder(convertView);
            convertView.setTag(wrapper);
        }
        else {
            wrapper=(CountryViewHolder)convertView.getTag();
        }

        wrapper.populateFrom(getItem(position));

        return(convertView);
    }
}
```

This adapter is somewhat more complex than the ones we showed in the [chapter on selection widgets](#). We will get into what `CountryAdapter` is doing, and the `CountryViewHolder` it references, in [a later chapter of this book](#). Suffice it to say for now that the rows in the list contain both the country name and its flag.

When the user taps on a row in our `ListView`, something needs to happen – specifically, the details of that country need to be displayed. However, displaying those details is not the responsibility of `CountriesFragment`, as it simply displays the list of countries and nothing else. Hence, we need to pass the event up to the hosting activity to handle.

To accomplish this, we have a custom interface for events raised by `CountriesFragment`, called `CountryListener`:

```
package com.commonware.android.eu4you;

public interface CountryListener {
```

```
void onCountrySelected(Country c);
boolean isPersistentSelection();
}
```

Any activity that hosts a `CountriesFragment` is responsible for implementing this interface, so we can call `onCountrySelected()` when the user clicks on a row in the list:

```
@Override
public void onItemClick(ListView l, View v, int position, long id) {
    CountryListener listener=(CountryListener) getActivity();

    if (listener.isPersistentSelection()) {
        listView().setChoiceMode(ListView.CHOICE_MODE_SINGLE);
        l.setItemChecked(position, true);
    }
    else {
        listView().setChoiceMode(ListView.CHOICE_MODE_NONE);
    }

    listener.onCountrySelected(Country.EU.get(position));
}
```

`CountriesFragment` also has quite a bit of code dealing with clicked-upon rows being in an “activated” state. This provides visual context to the user and is often used in the list-and-details pattern. For example, in the tablet renditions of Gmail shown earlier in this chapter, you will notice that the list on the left (e.g., list of labels) has one row highlighted with a blue background. This is the “activated” row, and it indicates the context for the material in the adjacent fragment (e.g., list of conversations in the label). Managing this “activated” state is a bit beyond the scope of this section, however, so we will delay discussion of that topic to [a later chapter in this book](#).

### DetailsFragment

The details to be displayed come in the form of a URL to a mobile Wikipedia page for a country, designed to be displayed in a `WebView`. The `EU4You` sample app makes use of the same `WebViewFragment` that we saw earlier in this book, such as in the tutorials. `DetailsFragment` itself, therefore, simply needs to expose some method to allow a hosting activity to tell it what URL to display:

```
package com.commonware.android.eu4you;

public class DetailsFragment extends WebViewFragment {
    public void loadUrl(String url) {
        getWebView().loadUrl(url);
    }
}
```

```
}  
}
```

You will notice that this fragment is not retained via `setRetainInstance()`. That is because, as you will see, we will not always be displaying this fragment. Fragments that are displayed in some configurations (e.g., landscape) but not in others (e.g., portrait), where a device might change between those configurations at runtime, cannot be retained without causing crashes.

### The Activities

Our launcher activity is also named `EU4You`. It uses two of the layouts shown above. Both are `main.xml`, but one is in `res/layout-large-land/`:

```
<?xml version="1.0" encoding="utf-8"?>  
<LinearLayout  
  xmlns:android="http://schemas.android.com/apk/res/android"  
  android:orientation="horizontal"  
  android:layout_width="fill_parent"  
  android:layout_height="fill_parent">  
  <FrameLayout  
    android:id="@+id/countries"  
    android:layout_weight="30"  
    android:layout_width="0px"  
    android:layout_height="fill_parent"  
  />  
  <FrameLayout  
    android:id="@+id/details"  
    android:layout_weight="70"  
    android:layout_width="0px"  
    android:layout_height="fill_parent"  
  />  
</LinearLayout>
```

The other is in `res/layout/`:

```
<?xml version="1.0" encoding="utf-8"?>  
<FrameLayout xmlns:android="http://schemas.android.com/apk/res/android"  
  android:id="@+id/countries"  
  android:layout_width="fill_parent"  
  android:layout_height="fill_parent"  
>
```

Both have a `FrameLayout` for the `CountriesFragment` (`R.id.countries`), but only the `res/layout-large-land/` edition has a `FrameLayout` for the `DetailsFragment` (`R.id.details`).

Here is the complete implementation of the `EU4You` activity:

## LARGE-SCREEN STRATEGIES AND TACTICS

---

```
package com.commonware.android.eu4you;

import android.content.Intent;
import android.os.Bundle;
import com.actionbarsherlock.app.SherlockFragmentActivity;

public class EU4You extends SherlockFragmentActivity implements
    CountryListener {
    private CountriesFragment countries=null;
    private DetailsFragment details=null;

    @Override
    public void onCreate(Bundle savedInstanceState) {
        super.onCreate(savedInstanceState);
        setContentView(R.layout.main);

        countries=
(CountriesFragment)getSupportFragmentManager().findFragmentById(R.id.countries);

        if (countries == null) {
            countries=new CountriesFragment();
            getSupportFragmentManager().beginTransaction()
                .add(R.id.countries, countries)
                .commit();
        }

        details=
(DetailsFragment)getSupportFragmentManager().findFragmentById(R.id.details);

        if (details == null && findViewById(R.id.details) != null) {
            details=new DetailsFragment();
            getSupportFragmentManager().beginTransaction()
                .add(R.id.details, details).commit();
        }
    }

    @Override
    public void onCountrySelected(Country c) {
        String url=getString(c.url);

        if (details != null && details.isVisible()) {
            details.loadUrl(url);
        }
        else {
            Intent i=new Intent(this, DetailsActivity.class);

            i.putExtra(DetailsActivity.EXTRA_URL, url);
            startActivity(i);
        }
    }

    @Override
```

```
public boolean isPersistentSelection() {
    return(details != null && details.isVisible());
}
}
```

The job of `onCreate()` is to set up the UI. So, we:

- See if we already have an instance of `CountriesFragment`, by asking our `FragmentManager` to give me the fragment in the `R.id.countries` slot — this might occur if we underwent a configuration change, as `CountriesFragment` is retained
- If we do not have a `CountriesFragment` instance, create one and execute a `FragmentTransaction` to load it into `R.id.countries` of our layout
- Find the `DetailsFragment` (which, since `DetailsFragment` is not retained, should always return `null`, but, as they say, “better safe than sorry”)
- If we do not have a `DetailsFragment` *and* the layout has a `R.id.details` slot, create a `DetailsFragment` and execute the `FragmentTransaction` to put it in that slot... but otherwise do nothing

The net result is that `EU4You` can correctly handle either situation, where we have both fragments or just one.

Similarly, the `onCountrySelected()` method (required by the `CountryListener` interface) will see if we have our `DetailsFragment` or not (and whether it is visible, or is hidden because we created it but it is not visible in the current screen orientation). If we do, we just call `loadUrl()` on it, to populate the `WebView`. If we do not have a visible `DetailsFragment`, we need to do something to display one. In principle, we could elect to execute a `FragmentTransaction` to replace the `CountriesFragment` with the `DetailsFragment`, but this can get complicated. Here, we start up a separate `DetailsActivity`, passing the URL for the chosen Country in an `Intent` extra.

`DetailsActivity` is similar:

```
package com.commonware.android.eu4you;

import android.os.Bundle;
import com.actionbarsherlock.app.SherlockFragmentActivity;

public class DetailsActivity extends SherlockFragmentActivity {
    public static final String EXTRA_URL=
        "com.commonware.android.eu4you.EXTRA_URL";
    private String url=null;
    private DetailsFragment details=null;
}
```

```
@Override
public void onCreate(Bundle savedInstanceState) {
    super.onCreate(savedInstanceState);

    details=
(DetailsFragment)getSupportFragmentManager().findFragmentById(R.id.details);

    if (details == null) {
        details=new DetailsFragment();

        getSupportFragmentManager().beginTransaction()
            .add(android.R.id.content, details)
            .commit();
    }

    url=getIntent().getStringExtra(EXTRA_URL);
}

@Override
public void onResume() {
    super.onResume();

    details.loadUrl(url);
}
}
```

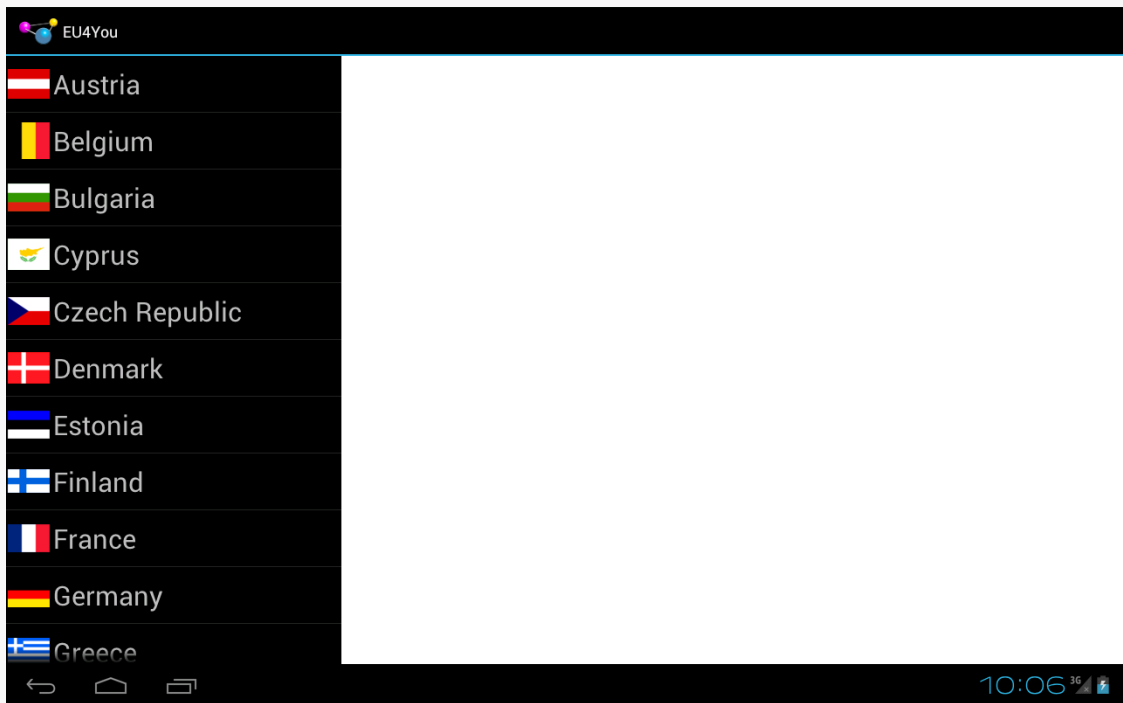
We create the `DetailsFragment` and load it into the layout, capture the URL from the Intent extra, and call `loadUrl()` on the `DetailsFragment`. However, since we are executing a `FragmentManager`, the actual UI for the `DetailsFragment` is not created immediately, so we cannot call `loadUrl()` right away (otherwise, `DetailsFragment` will try to pass it to a non-existent `WebView`, and we crash). So, we delay calling `loadUrl()` to `onResume()`, at which point the `WebView` should exist.

### The Results

On a larger-screen device, in landscape, we have both fragments, though there is nothing initially loaded into the `DetailsFragment`:

## LARGE-SCREEN STRATEGIES AND TACTICS

---



*Figure 211: EU4You, On a Tablet Emulator, Landscape*

Tapping on a country brings up the details on the right:

## LARGE-SCREEN STRATEGIES AND TACTICS

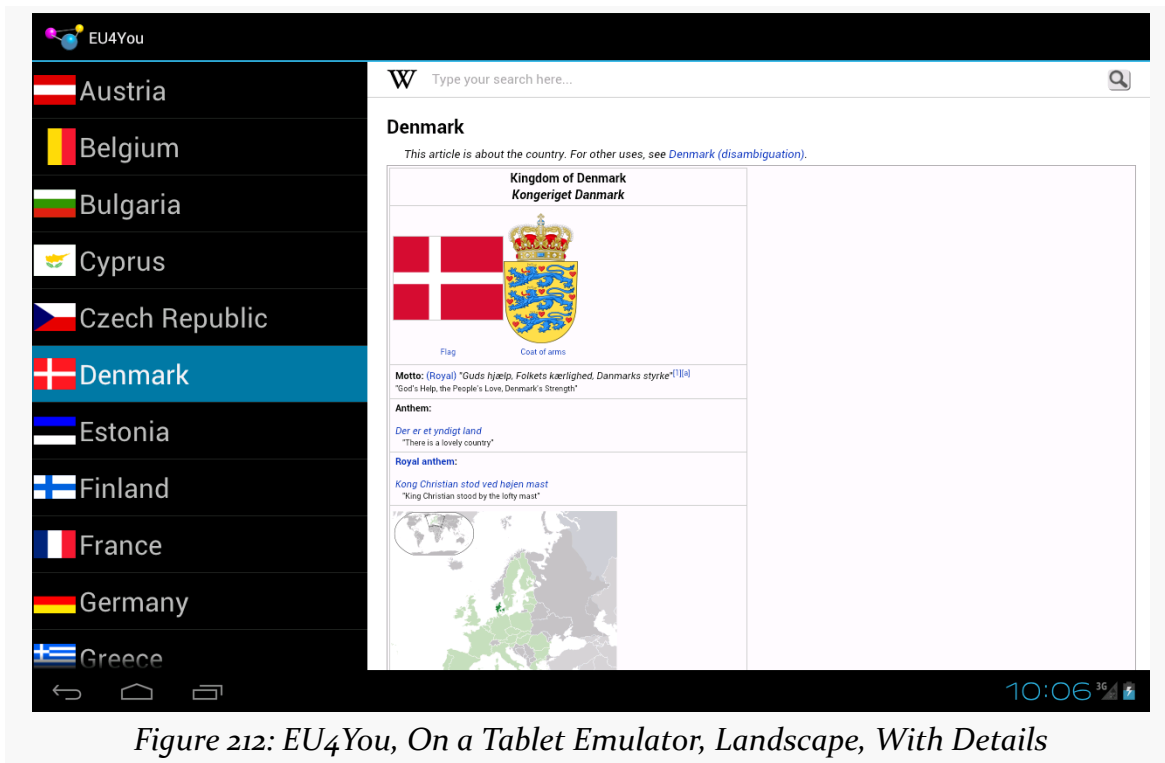


Figure 212: EU4You, On a Tablet Emulator, Landscape, With Details

In any other configuration, such as a smaller-screen device, we only see the CountriesFragment at the outset:





*Figure 213: EU4You, On a Phone Emulator*

Tapping on a country brings up the DetailsFragment full-screen in the DetailsActivity:



Figure 214: EU4You, On a Phone Emulator, Showing Details

## Showing More Pages

ViewPager is a popular container in Android, as horizontal swiping is an increasingly popular navigational model, to move between peer pieces of content (e.g., swiping between contacts, swiping between book chapters). In some cases, when the ViewPager is on a larger screen, we simply want larger pages — a digital book reader, for example, would simply have a larger page in a bigger font for easier reading.

Sometimes, though, we might not be able to take advantage of the full space offered by the large screen, particularly when our ViewPager takes up the whole screen. In cases like this, it might be useful to allow ViewPager, in some cases, to show more than one page at a time. Each “page” is then designed to be roughly phone-sized, and we choose whether to show one, two, or perhaps more pages at a time based upon the available screen space.

Mechanically, allowing ViewPager to show more than one page is fairly easy, involving overriding one more method in our PagerAdapter: `getPageWidth()`. To see this in action, take a look at the [ViewPager/MultiView1](#) sample project.

## LARGE-SCREEN STRATEGIES AND TACTICS

---

Each page in this sample is simply a TextView widget, using the activity's style's "large appearance", centered inside a LinearLayout:

```
<LinearLayout xmlns:android="http://schemas.android.com/apk/res/android"
    android:layout_width="match_parent"
    android:layout_height="match_parent"
    android:gravity="center"
    android:orientation="vertical">

    <TextView
        android:id="@+id/text"
        android:layout_width="wrap_content"
        android:layout_height="wrap_content"
        android:textAppearance="?android:attr/textAppearanceLarge"/>

</LinearLayout>
```

The activity, in onCreate(), gets our ViewPager from the res/layout/activity\_main.xml resource, and sets its adapter to be a SampleAdapter:

```
@Override
public void onCreate(Bundle savedInstanceState) {
    super.onCreate(savedInstanceState);
    setContentView(R.layout.activity_main);

    ViewPager pager=(ViewPager)findViewById(R.id.pager);

    pager.setAdapter(new SampleAdapter());
    pager.setOffscreenPageLimit(6);
}
```

In this case, SampleAdapter is not a FragmentPagerAdapter, nor a FragmentStatePagerAdapter. Instead, it is its own implementation of the PagerAdapter interface:

```
/*
 * Inspired by
 * https://gist.github.com/8cbe094bb7a783e37ad1
 */
private class SampleAdapter extends PagerAdapter {
    @Override
    public Object instantiateItem(ViewGroup container, int position) {
        View page=
            getLayoutInflater().inflate(R.layout.page, container, false);
        TextView tv=(TextView)page.findViewById(R.id.text);
        int blue=position * 25;

        tv.setText(String.format(getString(R.string.item), position + 1));
        page.setBackgroundColor(Color.argb(255, 0, 0, blue));
        container.addView(page);
    }
}
```

```
        return(page);
    }

    @Override
    public void destroyItem(ViewGroup container, int position,
        Object object) {
        container.removeView((View)object);
    }

    @Override
    public int getCount() {
        return(9);
    }

    @Override
    public float getPageWidth(int position) {
        return(0.5f);
    }

    @Override
    public boolean isViewFromObject(View view, Object object) {
        return(view == object);
    }
}
```

To create your own PagerAdapter, the big methods that you need to implement are:

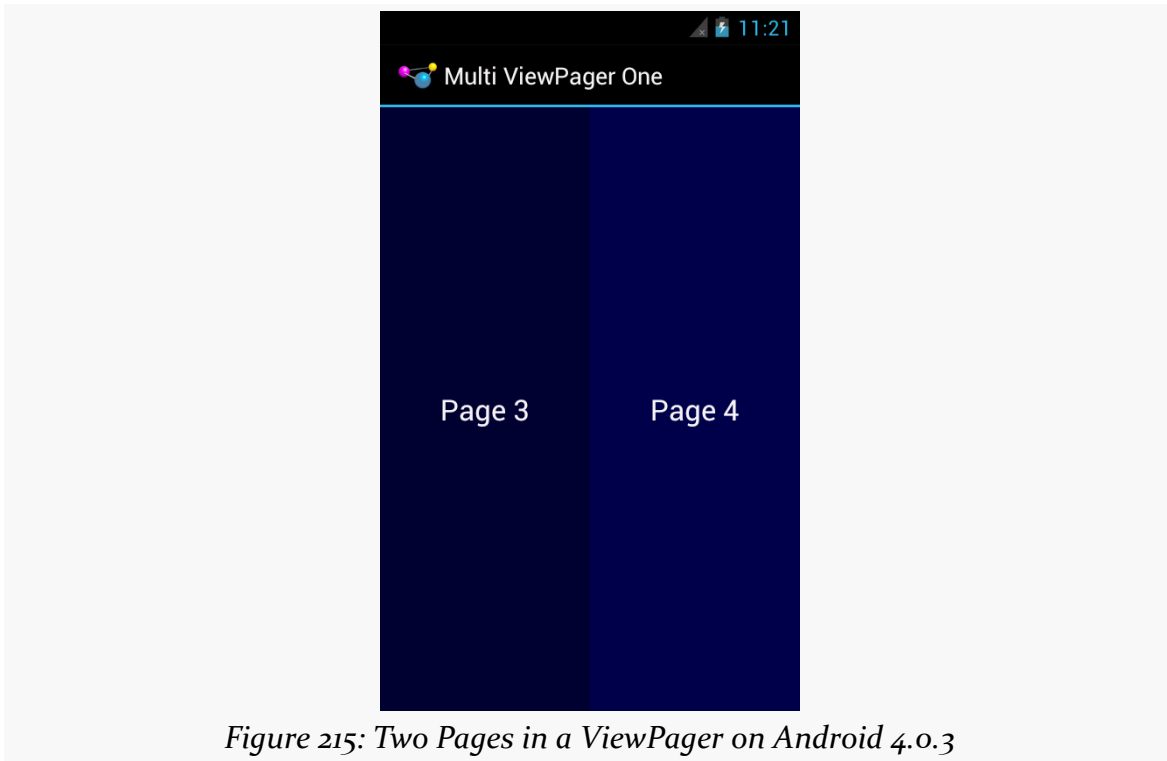
- `instantiateItem()`, where you create the page itself and add it to the supplied container. In this case, we inflate the page, set the text of the `TextView` based on the supplied position, set the background color of the page itself to be a different shade of blue based on the position, and use that for our page. We return some object that identifies this page; in this case, we return the inflated `View` itself. A fragment-based `PagerAdapter` would probably return the fragment.
- `destroyItem()`, where we need to clean up a page that is being removed from the pager, where the page is identified by the `Object` that we had previously returned from `instantiateItem()`. In our case, we just remove it from the supplied container.
- `isViewFromObject()`, where we confirm whether some specific page in the pager (represented by a `View`) is indeed tied to a specific `Object` returned from `instantiateItem()`. In our case, since we return the `View` from `instantiateItem()`, we merely need to confirm that the two objects are indeed one and the same.
- `getCount()`, as with the built-in `PagerAdapter` implementations, to return how many total pages there are.

## LARGE-SCREEN STRATEGIES AND TACTICS

---

In our case, we also override `getPageWidth()`. This indicates, for a given position, how much horizontal space in the `ViewPager` should be given to this particular page. In principle, each page could have its own unique size. The return value is a `float`, from `0.0f` to `1.0f`, indicating what fraction of the pager's width goes to this page. In our case, we return `0.5f`, to have each page take up half the pager.

The result is that we have two pages visible at a time:



*Figure 215: Two Pages in a ViewPager on Android 4.0.3*

It is probably also a good idea to call `setOffscreenPageLimit()` on the `ViewPager`, as we did in `onCreate()`. By default (and at minimum), `ViewPager` will cache three pages: the one presently visible, and one on either side. However, if you are showing more than one at a time, you should bump the limit to be 3 times the number of simultaneous pages. For a page width of `0.5f` — meaning two pages at a time — you would want to call `setOffscreenPageLimit(6)`, to make sure that you had enough pages cached for both the current visible contents and one full swipe to either side.

`ViewPager` even handles “partial swipes” — a careful swipe can slide the right-hand page into the left-hand position and slide in a new right-hand page. And `ViewPager` stops when you run out of pages, so the last page will always be on the right, no matter how many pages at a time and how many total pages you happen to have.

The biggest downside to this approach is that it will not work well with the current crop of indicators. `PagerTitleStrip` and `PagerTabStrip` assume that there is a single selected page. While the indicator will adjust properly, the visual representation shows that the left-hand page is the one selected (e.g., the tab with the highlight), even though two or more pages are visible. You can probably overcome this with a custom indicator (e.g., highlight the selected tab and the one to its right).

Also note that this approach collides a bit with `setPageMargin()` on `ViewPager`. `setPageMargin()` indicates an amount of whitespace that should go in a gutter between pages. In principle, this would work great with showing multiple simultaneous pages in a `ViewPager`. However, `ViewPager` does not take the gutter into account when interpreting the `getPageWidth()` value. For example, suppose `getPageWidth()` returns 0.5f and we `setPageMargin(20)`. On a 480-pixel-wide `ViewPager`, we will actually use 500 pixels: 240 for the left page, 240 for the right page, and 20 for the gutter. As a result, 20 pixels of our right-hand page are off the edge of the pager. Ideally, `ViewPager` would subtract out the page margin *before* applying the page width. One workaround is for you to derive the right `getPageWidth()` value based upon the `ViewPager` size and gutter yourself, rather than hard-coding a value. Or, build in your gutter into your page contents (e.g., using `android:layout_marginLeft` and `android:layout_marginRight`) and skip `setPageMargin()` entirely.

## Fragment FAQs

Here are some other common questions about the use of fragments in support of large screen sizes:

### Does *Everything* Have To Be In a Fragment?

In a word, no.

UI constructs that do not change based on screen size, configurations, and the like could simply be defined in the activity itself. For example, the activity can add items to the action bar that should be there regardless of what fragments are shown.

Things that span multiple fragments will also be part of the activity. The `ViewPager` is the classic example, as the built-in `PagerAdapter` implementations all use fragments. Since fragments cannot contain other fragments, the activity would directly host the `ViewPager`.

### What If Fragments Are Not Right For Me?

While fragments are useful, they do not solve all problems. Few games will use fragments for the core of game play, for example. Applications with other forms of specialized user interfaces — painting apps, photo editors, etc. — may also be better served by eschewing fragments *for those specific activities* and doing something else.

That “something else” might start with custom layouts for the different sizes and orientations. At runtime, you can determine what you need either by inspecting what you got from the layout, or by using `Configuration` and `DisplayMetrics` objects to determine what the device capabilities are (e.g., screen size). The activity would then need to have its own code for handling whatever you want to do differently based on screen size (e.g., offering a larger painting canvas plus more on-screen tool palettes).

### Do Fragments Work on Google TV?

Much of the focus on “larger-screen devices” has been on tablets, because, as of the time of this writing, they are the most popular “larger-screen devices” in use. However, there is also Google TV to consider, as it presents itself as a `-large` (720p) or `-xlarge` (1080p) screen. Fragments can certainly help with displaying a UI for Google TV, but there are other design considerations to take into account, based upon the fact that the user sits much further from a TV than they do from a phone or tablet (so-called “10-foot user experience”).

More coverage of developing for Google TV can be found in [a later chapter of this book](#).

## Screen Size and Density Tactics

Even if we take the “tablet = several phones” design approach, the size of the “phone” will vary, depending on the size of the tablet. Plus, there are real actual *phones*, and those too vary in size. Hence, our fragments (or activities hosting their own UI directly) need to take into account micro fluctuations in size, as well as the macro ones.

Screen density is also something that affects us tactically. It is rare that an application will make wholesale UI changes based upon whether the screen is 160dpi or 240dpi or 320dpi or something else. However, changes in density can certainly impact the sizes of things, like images, that are intrinsically tied to pixel sizes. So, we

need to take density into account as we are crafting our fragments to work well in a small range of sizes.

### Dimensions and Units

As a unit of measure, the pixel (px) is a poor choice, because its size varies by density. Two phones might have very similar screen sizes but radically different densities. Anything specified in terms of pixels will be smaller on the higher-density device, and typically you would want them to be about the same size. For example, a Button should not magically shrink for a ~4" phone just because the phone happens to have a much higher screen density than some other phone.

The best answer is to avoid specifying concrete sizes where possible. This is why you tend to see containers, and some widgets, use `fill_parent`, `match_parent`, and `wrap_content` for their size — those automatically adjust based upon device characteristics.

Some places, though, you have to specify a more concrete size, such as with padding or margins. For these, you have two major groups of units of measure to work with:

- Those based upon pixels, but taking device characteristics into account. These include density-independent pixels (dp or dip), which try to size each dp to be about 1/160 of an inch. These also include scaled pixels (sp), which scales the size based upon the default font size on the device — sp is often used with `TextView` (and subclasses) for `android:textSize` attributes.
- Those based purely on physical units of measure: mm (millimeters), in (inches), and pt (points = 1/72 of an inch).

Any of those tends to be better than px. Which you choose will depend on which you and your graphics designer are more comfortable with.

If you find that there are cases where the dimensions you want to use vary more widely than the automatic calculations from these density-aware units of measure, you can use dimension resources. Create a `dimens.xml` file in `res/values/` and related resource sets, and put in there `<dimen>` elements that give a dimension a name and a size. In addition to perhaps making things a bit more DRY (“don’t repeat yourself”), you can perhaps create different values of those dimensions for different screen sizes, densities, or other cases as needed.



### Layouts and Stretching

Web designers need to deal with the fact that the user might resize their browser window. The approaches to deal with this are called “fluid” designs.

Similarly, Android developers need to create “fluid” layouts for fragments, rows in a `ListView`, and so on, to deal with similar minor fluctuations in size.

Each of “The Big Three” container classes has its approach for dealing with this:

- Use `android:layout_weight` with `LinearLayout` to allocate extra space
- Use `android:stretchColumns` and `android:shrinkColumns` with `TableLayout` to determine which columns should absorb extra space and which columns should be forcibly “shrunk” to yield space for other columns if we lack sufficient horizontal room
- Use appropriate rules on `RelativeLayout` to anchor widgets as needed to other widgets or the boundaries of the container, such that extra room flows naturally wherever the rules call for

### Drawables That Resize

Images, particularly those used as backgrounds, will need to be resized to take everything into account:

- screen size and density
- size of the widget, and its contents, for which it serves as the background (e.g., amount of prose in a `TextView`)

Android supports what is known as the “nine-patch” PNG format, where resizing information is held in the PNG itself. This is typically used for things like rounded rectangles, to tell Android to stretch the straight portions of the rectangle but to not stretch the corners. Nine-patch PNG files will be examined in greater detail in [a later chapter of this book](#).

The `ShapeDrawable` XML drawable resource uses an ever-so-tiny subset of SVG (Scalable Vector Graphics) to create a vector art definition of an image. Once again, this tends to be used for rectangles and rounded rectangles, particularly those with a gradient fill. Since Android interprets the vector art definition at runtime, it can create a smooth gradient, interpolating all intervening colors from start to finish. Stretching a PNG file — even a nine-patch PNG file — tends to result in “banding effects” on the gradients. `ShapeDrawable` is also covered later in this book.

Third-party libraries can also help. The [svg-android](#) project supplies a JAR that handles more SVG capabilities than does ShapeDrawable, though it too does not cover the entire SVG specification.

### Drawables By Density

Sometimes, though, there is no substitute for your traditional bitmap image. Icons and related artwork are not necessarily going to be stretched at runtime, but they are still dependent upon screen density. A 80x80 pixel image may look great on a Samsung Galaxy Nexus or other -xhdpi device, coming in at around  $\sim 1/4$ " on a side. However, when viewed on a -mdpi device, that same icon will be  $\sim 1/2$ " on a side, which may be entirely too large.

The best answer is to create multiple renditions of the icon at different densities, putting each icon in the appropriate drawable resource directory (e.g., `res/drawable-mdpi`, `res/drawable-hdpi`). This is what Android Asset Studio did for us in the tutorials, creating launcher icons from some supplied artwork for all four densities. Even better is to create icons tailored for each density — rather than just reducing the pixel count, take steps to draw an icon that will still make sense to the user at the lower pixel count, exaggerating key design features and dropping other stuff off. Google's Kiril Grouchnikov has [an excellent blog post on this aspect](#)

However, Android will let you cheat.

If you supply only some densities, but your app runs on a device with a different density, Android will automatically resample your icons to try to generate one with the right density, to keep things the same size. On the plus side, this saves you work — perhaps you only ship an -xhdpi icon and let Android do the rest. And it can reduce your APK size by a bit. However, there are costs:

- This is a bit slower at runtime and consumes a bit more battery
- Android's resampling algorithm may not be as sophisticated as that of your preferred image editor (e.g., Photoshop)
- You cannot finesse the icon to look better than a simple resampling (e.g., drop off design elements that become unidentifiable)

### Other Considerations

There are other things you should consider when designing your app to work on multiple screen sizes, beyond what is covered above.

### Small-Screen Devices

It is easy to think of screen size issues as being “phones versus tablets”. However, not only do tablets come in varying sizes (5” Samsung Galaxy Note to a bunch of 10.1” tablets), but phones come in varying sizes. Those that have less than a 3” diagonal screen size will be categorized as -small screen devices, and you can have different layouts for those.

Getting things to work on small screens is sometimes more difficult than moving from normal to larger screens, simply because you lack sufficient room. You can only shrink widgets so far before they become unreadable or “untappable”. You may need to more aggressively use `ScrollView` to allow your widgets to have more room, but requiring the user to pan through your whole fragment’s worth of UI. Or, you may need to divide your app into more fragments than you originally anticipated, and use more activities or other tricks to allow the user to navigate the fragments individually on small-screen devices, while stitching them together into larger blocks for larger phones.

### Avoid Full-Screen Backgrounds

Android runs in lots of different resolutions.

Lots and lots of different resolutions.

Trying to create artwork for each and every resolution in use today will be tedious and fragile, the latter because new resolutions pop up every so often, ones you may not be aware of.

Hence, try to design your app to avoid some sort of full-screen background, where you are expecting the artwork to perfectly fit the screen. Either:

- Do not use a background, or
- Use a background, but one that is designed to be cropped to fit and will look good in its cropped state, or
- Use a background, but one that can naturally bleed into some solid fill to the edges (e.g., a starfield that simply lacks stars towards the edges), so you can “fill in” space around your background with that solid color to fill the screen, or
- Dynamically draw the background (e.g., a starfield where you place the stars yourself at runtime using 2D graphics APIs)

For most conventional apps, just using the background from your stock theme will typically suffice. This problem is much bigger for 2D games, which tend to rely upon backgrounds as a game surface.

### Manifest Elements for Screen Sizes

There are two elements you can add to your manifest that impact how your application will behave with respect to screen sizes.

`<compatible-screens>` serves as an advertisement of your capabilities, to the Google Play Store and similar “markets”. You can have a `<compatible-screens>` element with one or more child `<screen>` elements — each `<screen>` enumerates a combination of screen size and screen density that you support:

```
<compatible-screens>
  <!-- all possible normal size screens -->
  <screen android:screenSize="normal" android:screenDensity="ldpi" />
  <screen android:screenSize="normal" android:screenDensity="mdpi" />
  <screen android:screenSize="normal" android:screenDensity="hdpi" />
  <screen android:screenSize="normal" android:screenDensity="xhdpi" />
  <!-- all possible large size screens -->
  <screen android:screenSize="large" android:screenDensity="ldpi" />
  <screen android:screenSize="large" android:screenDensity="mdpi" />
  <screen android:screenSize="large" android:screenDensity="hdpi" />
  <screen android:screenSize="large" android:screenDensity="xhdpi" />
</compatible-screens>
```

The Google Play Store will filter your app, so it will not show up on devices that have screens that do not meet one of your `<screen>` elements.

Note that `<compatible-screens>` was added in API Level 9, but that simply means that your build target will need to be API Level 9 or higher. Since `<compatible-screens>` only affects markets, not your app’s runtime behavior, there is no harm in having this element in your manifest when it is run on older devices.

There is also a `<supports-screens>` element, as we saw when we set up our initial project in the tutorials. Here, you indicate what screen sizes you support, akin to `<compatible-screens>` (minus any density declarations). And, the Google Play Store will filter your app, so it will not show up on devices that have screens *smaller than what you support*.

So, for example, suppose that you have a `<supports-screens>` element like this:

## LARGE-SCREEN STRATEGIES AND TACTICS

---

```
<supports-screens android:smallScreens="false"  
                  android:normalScreens="true"  
                  android:largeScreens="true"  
                  android:xlargeScreens="false"  
>
```

You will not show up in the Google Play Store for any -small screen devices. However, you *will* show up in the Google Play Store for any -xlarge screen devices — Android will merely apply some runtime logic to try to help your app run well on such screens. So, while `<compatible-screens>` is purely a filter, `<supports-screens>` is a filter for smaller-than-supported screens, and a runtime “give me a hand!” flag for larger-than-supported screens.

# Tutorial #19 - Supporting Large Screens

---

So far, we have created a variety of fragments that are being used one at a time in a hosting activity: notes, help, and about. And, on smaller-screen devices, like phones, that is probably the best solution. But on `-large` and `-xlarge` devices, like 10" tablets, it might be nice to be able to have some of those fragments take over a part of the main activity's space. For example, the user could be reading the chapter and reading the online help.

Hence, in this tutorial, we will arrange for the help and about fragments to be loaded into `EmPubLiteActivity` directly on `-large` and `-xlarge` devices, while retaining our existing functionality for other devices.

This is a continuation of the work we did in [the previous tutorial](#).

You can find [the results of the previous tutorial](#) and [the results of this tutorial](#) in [the book's GitHub repository](#).

Note that if you are importing the previous code to begin work here, you will also need the [copy of ActionBarSherlock in this book's GitHub repository](#), and to make sure that your imported `EmPubLite` project references the `ActionBarSherlock` project as a library.

## Step #1: Creating Our Layouts

The simplest way to both add a place for these other fragments and to determine when we should be using these other fragments in the main activity is to create new layout resource sets for `-large` devices, with customized versions of `main.xml` to be

## TUTORIAL #19 - SUPPORTING LARGE SCREENS

---

used by `EmPubLiteActivity`. Android will automatically use `-large` resources on `-xlarge` devices if `-xlarge` equivalents do not exist.

If you wish to make this change using Eclipse's wizards and tools, follow the instructions in the "Eclipse" section below. Otherwise, follow the instructions in the "Outside of Eclipse" section (appears after the "Eclipse" section).

### Eclipse

First, right-click over the `res/` folder, and choose `New > Folder` from the context menu. Fill in `layout-large-land` as the folder name, then click "Finish" to create the folder.

Then, right-click over the `res/layout/main.xml` file and choose "Copy" from the context menu. After that, right-click over the new `res/layout-large-land/` folder and choose "Paste" from the context menu. This makes a copy of your `main.xml` resource that we can use for `-large-land` devices.

Double-click on the `res/layout-large-land/main.xml` file to bring it up in the graphical layout editor. In the Outline pane, right-click on the `RelativeLayout` and choose "Wrap in Container..." from the context menu. Choose "LinearLayout (horizontal)" in the drop-down list of available containers, and give the container some ID (the value does not matter, as we will not be using it, but the dialog requires it). Click OK to wrap our `RelativeLayout` in the horizontal `LinearLayout`.

Click on the `RelativeLayout` in the Outline pane. In the Properties pane, in the "Layout Parameters" group, fill in 7 in the "Weight" field. Switch over to the XML editor and fill in `0dp` for `android:layout_width` for the `RelativeLayout` (this cannot be done in the Properties pane due to [a bug in the current version of the tools](#)).

In the Palette, switch to the Advanced group of widgets, and drag a `View` over to the Outline pane and drop it on the `LinearLayout`, which will add it to the end of the `LinearLayout` roster of children. Make the following adjustments to the properties of the `View` using the Properties pane:

- Set the Id to `@+id/divider`
- Set the Height to `match_parent`
- Set the Background to `#AA000000`
- Set the Visibility to `gone`

## TUTORIAL #19 - SUPPORTING LARGE SCREENS

---

Then, switch over to the XML and give the View an `android:layout_width` of 2dp. Also, if you see an erroneous `android:layout_weight` attribute on this View, get rid of it.

Back in the Palette, switch to the Layouts group of widgets, and drag a `FrameLayout` over to the Outline pane and drop it on the `LinearLayout`, adding it as a third child. Make the following adjustments to the properties of the `FrameLayout` using the Properties pane:

- Set the Id to `@+id/sidebar`
- Set the Weight to 0

Then, switch over to the XML and give the `FrameLayout` an `android:layout_width` of 0dp.

Save your changes (e.g., `<Ctrl>-<S>`).

Then, right-click over the `res/` folder, and choose `New > Folder` from the context menu. Fill in `layout-large` as the folder name, then click “Finish” to create the folder.

Then, right-click over the `res/layout-large-land/main.xml` file and choose “Copy” from the context menu. After that, right-click over the new `res/layout-large/` folder and choose “Paste” from the context menu.

Double-click on `res/layout-large/main.xml` file, to bring it up in the graphical layout editor. Click on the `LinearLayout` and, in the Properties pane, set the “Orientation” to be vertical.

Then, switch over to the XML view, and swap the `android:layout_width` and `android:layout_height` values for the `RelativeLayout`, the View, and the `FrameLayout`. When you are done, each should have an `android:layout_width` of `match_parent` and an `android:layout_height` of 0dp (except the View, which should be 2dp).

Save your changes (e.g., `<Ctrl>-<S>`).

### Outside of Eclipse

Create a `res/layout-large-land/` directory in your project, and create a `main.xml` file in there with the following contents:



## TUTORIAL #19 - SUPPORTING LARGE SCREENS

---

```
<LinearLayout xmlns:android="http://schemas.android.com/apk/res/android"
  xmlns:tools="http://schemas.android.com/tools"
  android:id="@+id/foo"
  android:layout_width="match_parent"
  android:layout_height="match_parent">

  <RelativeLayout
    android:layout_width="0dp"
    android:layout_height="match_parent"
    android:layout_weight="7">

    <ProgressBar
      android:id="@+id/progressBar1"
      style="?android:attr/progressBarStyleLarge"
      android:layout_width="wrap_content"
      android:layout_height="wrap_content"
      android:layout_centerHorizontal="true"
      android:layout_centerVertical="true"/>

    <android.support.v4.view.ViewPager
      android:id="@+id/pager"
      android:layout_width="fill_parent"
      android:layout_height="fill_parent"
      android:visibility="gone"/>
  </RelativeLayout>

  <View
    android:id="@+id/divider"
    android:layout_width="2dp"
    android:layout_height="match_parent"
    android:background="#AA000000"
    android:visibility="gone"/>

  <FrameLayout
    android:id="@+id/sidebar"
    android:layout_width="0dp"
    android:layout_height="match_parent"
    android:layout_weight="0">

  </FrameLayout>
</LinearLayout>
```

Then, create a `res/layout-large/` directory in your project, and create a `main.xml` file in there with the following contents:

```
<LinearLayout xmlns:android="http://schemas.android.com/apk/res/android"
  xmlns:tools="http://schemas.android.com/tools"
  android:id="@+id/foo"
  android:layout_width="match_parent"
  android:layout_height="match_parent"
  android:orientation="vertical">
```

```
<RelativeLayout
    android:layout_width="match_parent"
    android:layout_height="0dp"
    android:layout_weight="7">

    <ProgressBar
        android:id="@+id/progressBar1"
        style="?android:attr/progressBarStyleLarge"
        android:layout_width="wrap_content"
        android:layout_height="wrap_content"
        android:layout_centerHorizontal="true"
        android:layout_centerVertical="true"/>

    <android.support.v4.view.ViewPager
        android:id="@+id/pager"
        android:layout_width="fill_parent"
        android:layout_height="fill_parent"
        android:visibility="gone"/>
</RelativeLayout>

<View
    android:id="@+id/divider"
    android:layout_width="match_parent"
    android:layout_height="2dp"
    android:background="#AA000000"
    android:visibility="gone"/>

<FrameLayout
    android:id="@+id/sidebar"
    android:layout_width="match_parent"
    android:layout_height="0dp"
    android:layout_weight="0">

</FrameLayout>

</LinearLayout>
```

## Step #2: Loading Our Sidebar Widgets

Now that we added the divider widget and sidebar container to (some of) our layouts, we need to access those widgets at runtime.

So, in `EmPubLiteActivity`, add data members for them:

```
private View sidebar=null;
private View divider=null;
```

Then, in `onCreate()` of `EmPubLiteActivity`, initialize those data members, sometime after the call to `setContentView()`:

```
sidebar=findViewById(R.id.sidebar);
divider=findViewById(R.id.divider);
```

### Step #3: Opening the Sidebar

A real production-grade app would use animated effects to hide and show our sidebar. However, we have not yet covered animations in this book, so we will simply:

- Cause the divider to become visible
- Adjust the `android:layout_weight` of our sidebar to be 3 instead of 0, giving it ~30% of the screen (with the original `RelativeLayout` getting 70%, courtesy of its `android:layout_weight="7"`)

With that in mind, add the following implementation of an `openSidebar()` method to `EmPubLiteActivity`:

```
void openSidebar() {
    LinearLayout.LayoutParams p=
        (LinearLayout.LayoutParams)sidebar.getLayoutParams();
    if (p.weight == 0) {
        p.weight=3;
        sidebar.setLayoutParams(p);
    }
    divider.setVisibility(View.VISIBLE);
}
```

Here, we:

- Get the existing `LinearLayout.LayoutParams` from the sidebar
- If it is still 0 (meaning the sidebar has not been opened), assign it a weight of 3, update the layout via `setLayoutParams()`, and toggle the visibility of the divider

### Step #4: Loading Content Into the Sidebar

Now that we can get our sidebar to appear, we need to load content into it... but only if we have the sidebar. If `EmPubLiteActivity` loads a layout that does not have the sidebar, we need to stick with our existing logic that starts up an activity to display the content.

## TUTORIAL #19 - SUPPORTING LARGE SCREENS

---

With that in mind, add data members to `EmPubLiteActivity` to hold onto our help and about fragments:

```
private SimpleContentFragment help=null;
private SimpleContentFragment about=null;
```

Also add a pair of static data members that will be used as tags for identifying these fragments in our `FragmentManager`:

```
private static final String HELP="help";
private static final String ABOUT="about";
```

Also add a pair of static data members that will hold the paths to our help and about assets, since we will be referring to them from more than one place when we are done:

```
private static final String FILE_HELP=
    "file:///android_asset/misc/help.html";
private static final String FILE_ABOUT=
    "file:///android_asset/misc/about.html";
```

In `onCreate()` of `EmPubLiteActivity`, initialize the fragments from the `FragmentManager`:

```
help=
    (SimpleContentFragment)getSupportFragmentManager().findFragmentByTag(HELP);
about=
    (SimpleContentFragment)getSupportFragmentManager().findFragmentByTag(ABOUT);
```

The net result is that *if* we are returning from a configuration change, we will have our fragments, otherwise we will not at this point.

Next, add the following methods to `EmPubLiteActivity`:

```
void showAbout() {
    if (sidebar != null) {
        openSidebar();

        if (about == null) {
            about=SimpleContentFragment.newInstance(FILE_ABOUT);
        }

        getSupportFragmentManager().beginTransaction()
            .addToBackStack(null)
            .replace(R.id.sidebar, about).commit();
    }
}
```

## TUTORIAL #19 - SUPPORTING LARGE SCREENS

---

```
else {
    Intent i=new Intent(this, SimpleContentActivity.class);

    i.putExtra(SimpleContentActivity.EXTRA_FILE, FILE_ABOUT);
    startActivity(i);
}

void showHelp() {
    if (sidebar != null) {
        openSidebar();

        if (help == null) {
            help=SimpleContentFragment.newInstance(FILE_HELP);
        }

        getSupportFragmentManager().beginTransaction()
            .addToBackStack(null)
            .replace(R.id.sidebar, help).commit();
    }
    else {
        Intent i=new Intent(this, SimpleContentActivity.class);

        i.putExtra(SimpleContentActivity.EXTRA_FILE, FILE_HELP);
        startActivity(i);
    }
}
```

Both of these methods follows the same basic recipe:

- Check to see if sidebar is null, to see if we have a sidebar or not
- If we have a sidebar, call openSidebar() to ensure the user can see the sidebar, create our Fragment if we do not already have it, and use a FragmentTransaction to replace whatever was in the sidebar with the new Fragment
- If we do not have the sidebar, launch an activity with an appropriately-configured Intent

Note a couple of things with our FragmentTransaction objects:

- We use addToBackStack(null), so if the user presses BACK, Android will reverse this transaction
- We use replace() instead of add(), as there may already be a fragment in the sidebar (replace() will behave the same as add() for an empty sidebar)

Then, in the onOptionsItemSelected() of EmPubLiteActivity, replace the about, and help case blocks to use the newly-added methods, replacing their existing implementations:

```
@Override
public boolean onOptionsItemSelected(MenuItem item) {
    switch (item.getItemId()) {
        case android.R.id.home:
            pager.setCurrentItem(0, false);
            return(true);

        case R.id.notes:
            Intent i=new Intent(this, NoteActivity.class);
            i.putExtra(NoteActivity.EXTRA_POSITION, pager.getCurrentItem());
            startActivity(i);
            return(true);

        case R.id.update:
            WakefulIntentService.sendWakefulWork(this,
                                                    DownloadCheckService.class);

            return(true);

        case R.id.about:
            showAbout();

            return(true);

        case R.id.help:
            showHelp();

            return(true);

        case R.id.settings:
            startActivity(new Intent(this, Preferences.class));
            return(true);
    }

    return(super.onOptionsItemSelected(item));
}
```

### Step #5: Removing Content From the Sidebar

While `addToBackStack(null)` will allow Android to automatically remove fragments as the user presses BACK, that will not cause our sidebar to magically close. Rather, we need to do that ourselves.

The easiest way to track this is to track the state of the “back stack”. So, add `implements FragmentManager.OnBackStackChangeListener` to the declaration of `EmPubLiteActivity`, and in `onCreate()` of `EmPubLiteActivity`, add the following lines, sometime after you initialized the sidebar and divider data members:

```
getSupportFragmentManager().addOnBackStackChangeListener(this);

if (getSupportFragmentManager().getBackStackEntryCount() > 0) {
```

## TUTORIAL #19 - SUPPORTING LARGE SCREENS

---

```
openSidebar();  
}
```

The first statement registers our activity as receiving events related to changes in the state of the back stack. The rest of that code will reopen our sidebar if, due to a configuration change, we have fragments on the back stack — by default, our sidebar is closed, as that is the state that is encoded in the layout files.

To make this compile, we need to implement `onBackStackChanged()` in `EmPubLiteActivity`:

```
@Override  
public void onBackStackChanged() {  
    if (getSupportFragmentManager().getBackStackEntryCount() == 0) {  
        LinearLayout.LayoutParams p=  
            (LinearLayout.LayoutParams)sidebar.getLayoutParams();  
        if (p.weight > 0) {  
            p.weight=0;  
            sidebar.setLayoutParams(p);  
            divider.setVisibility(View.GONE);  
        }  
    }  
}
```

Here, if our back stack is empty, we reverse the steps from `openSidebar()` and close it back up again, hiding the divider and setting the sidebar's weight to 0.

At this point, if you build the project and run it on a `-large` or `-xlarge` device or emulator (e.g., a `WXGA800` emulator image with default settings), and you choose to view the notes, help, or about, you will see the sidebar appear, whether in portrait or landscape.

# Backwards Compatibility Strategies and Tactics

---

Android is an ever-moving target. The first Android device (T-Mobile G1/HTC Dream) was released in October 2008, running Android 1.0. In December 2011, the Galaxy Nexus was released, running Android 4.0. Hence, we have averaged one major release per year, plus numerous significant minor releases (e.g., 2.1, 2.2, 2.3).

The Android Developer site maintains a chart and table showing the most recent [breakdown of OS versions](#) making requests of the Play Store.

Most devices tend to be clustered around 1–3 minor releases. However, these are never the most recent release, which takes time to percolate through the device manufacturers and carriers and onto devices, whether those are new sales or upgrades to existing devices.

Some people panic when they realize this.

Panic is understandable, if not necessary. This is a well-understood problem, that occurs frequently within software development — ask any Windows developer who had to simultaneously support everything from Windows 98 to Windows XP. Moreover, there are many things in Android designed to make this problem as small as possible. What you need are the strategies and tactics to make it all work out.

## Think Forwards, Not Backwards

Android itself tries very hard to maintain backwards compatibility. While each new Android release adds many classes and methods, relatively few are marked as deprecated, and almost none are outright eliminated. And, in Android, “deprecated”



means “there’s probably a better solution for what you are trying to accomplish, though we will maintain this option for you as long as we can”.

Despite this, many developers aim purely for the lowest common denominator. Aiming to support older releases is noble. Ignoring what has happened since those releases is stupid, if you are trying to distribute your app to the public via the Play Store or similar mass-distribution means.

Why? You want your app to be distinctive, not decomposing.

For example, as we saw in the chapter on the action bar, adding one line to the manifest (`android:targetSdkVersion="11"`) gives you the action bar, the holographic widget set (e.g., `Theme.Holo`), the new style of options menu, and so on. Those dead-set on avoiding things newer than Android 2.1 would not use this attribute. As a result, on Android 3.0+ devices, their apps will tend to look old. Some will not, due to other techniques they are employing (e.g., running games in a full-screen mode), but many will.

You might think that this would not matter. After all, according to that same chart shown above, at that time, 3.9% of Android users had Android 3.0+ devices, which is not that many.

However, those in position to trumpet your application — Android enthusiast bloggers chief among them — will tend to run newer equipment. Their opinion matters, if you are trying to have their opinion sway others relative to your app. Hence, if you look out-of-touch to them, they may be less inclined to provide glowing recommendations of your app to their readers.

Besides, not everything added to newer versions of Android is pure “eye candy”. It is entirely possible that features in the newer Android releases might help make your app stand out from the competition, whether it is making greater use of NFC or offering tighter integration to the stock Calendar application or whatever. By taking an “old features only” approach, you leave off these areas for improvement.

And, to top it off, the world moves faster than you think. It takes about a year for a release to go from release to majority status (or be already on the downslope towards oblivion, passed over by something newer still). You need to be careful that the decisions you make today do not doom you tomorrow. If you focus on “old features only”, how much rework will it take you to catch up in six months, or a year?

Hence, this book advocates an approach that differs from that taken by many: aim high. Decide what features you want to use, whether those features are from older releases or the latest-and-greatest release. Then, write your app using those features, and take steps to ensure that everything still works reasonably well (if not as full-featured) on older devices. This too is a well-trodden path, used by Web developers for ages (e.g., support sexy stuff in Firefox and Safari, while still gracefully degrading for IE6). And the techniques that those Web developers use have their analogous techniques within the Android world.

### **Aim Where You Are Going**

One thing to bear in mind is that the OS distribution chart and table from the Android Developers blog shown above is based on requests to the Android Market.

This is only directly relevant if you are actually distributing through the Play Store.

If you are distributing through the Amazon AppStore, or to device-specific outlets (e.g., Barnes & Noble NOOK series), you will need to take into account what sorts of devices are using those means of distribution.

If you are specifically targeting certain non-Play Store devices, like the Kindle Fire, you will need to take into account what versions of Android they run.

If you are building an app to be distributed by a device manufacturer on a specific device, you need to know what Android version will (initially) be on that device and focus on it.

If you are distributing your app to employees of a firm, members of an organization, or the like, you need to determine if there is some specific subset of devices that they use, and aim accordingly. For example, some enterprises might distribute Android devices to their employees, in which case apps for that enterprise should run on those devices, not necessarily others.

### **A Target-Rich Environment**

There are a few places in your application where you will need to specify Android API levels of relevance to your code.

## BACKWARDS COMPATIBILITY STRATEGIES AND TACTICS

---

The most important one is the `android:minSdkVersion` attribute, as discussed early in this book. You need to set this to the oldest version of Android you are willing to support, so you will not be installed on devices older than that.

There is also `android:targetSdkVersion`, mentioned in passing earlier in this chapter. In the abstract, this attribute tells Android “this is the version of Android I was thinking of when I wrote the code”. Android can use this information to help both backwards and forwards compatibility. Historically, this was under-utilized. However, with API Level 11 and API Level 14, `android:targetSdkVersion` took on greater importance. Specifying 11 or higher gives you the action bar and all the rest of the look-and-feel introduced in the Honeycomb release. Specifying 14 or higher will give you some new features added in Ice Cream Sandwich, such as automatic whitespace between your app widgets and other things on the user’s home screen. In general, use a particular `android:targetSdkVersion` when instructions tell you to.

There is an `android:maxSdkVersion`, which indicates the *newest* version of Android you would like to support. However, this will only serve as a filter on the Play Store. If a user has, say, a Gingerbread device, and your app has `android:maxSdkVersion="10"`, and the user’s device gets an upgrade to Ice Cream Sandwich, your app may remain installed. In that case, your app *will* be running on a version higher than the maximum you specified. However, you will not show up in the Market for devices running a newer version of Android than you specified. Google strongly discourages the use of this attribute.

The fourth place — and perhaps the one that confuses developers the most — is the build target.

Part of the confusion is the multiple uses of the term “target”. The build target has nothing to do with `android:targetSdkVersion`. Nor is it strictly tied to what devices you are targeting.

Rather, it is a very literal term: it is the target **of the build**. It indicates:

- What version of the Android class library you wish to compile against, dictating what classes and methods you will be able to refer to directly
- What rules to apply when interpreting resources and the manifest, to complain about things that are not recognized

The net is that you set your build target to be the lowest API level that has everything you are using directly.

## A Little Help From Your Friends

The simplest way to use a feature yet support devices that lack the feature is to use a compatibility library that enables the feature for more devices.

We have seen two of these so far in the book:

- The Android Support package, offering implementations of fragments and loaders going back to Android 1.6
- ActionBarSherlock, providing Android 2.x devices (and beyond) with action bars

In these cases, the API for using the compatibility library is nearly identical to using the native Android capability, mostly involving slightly different package names (e.g., `android.support.v4.app.Fragment` instead of `android.app.Fragment`).

So, if there is something new that you want to use on older devices, and the new feature is not obviously tied to hardware, see if there is a “backport” of the feature available to you. For example, Android 4.0 added a `GridLayout`, to try to simplify some UI patterns that are tedious to do with nested `LinearLayout` containers or a `RelativeLayout`. While `GridLayout` itself is only available natively on Android starting with 4.0, it is entirely possible to take the source code for `GridLayout` and get it working on older devices, as [one developer did](#). Of course, after that developer went through all of that work, Google added `GridLayout` to the Android Support package.

These sorts of backports can then be dropped once you drop support for the older devices that required them. For example, if the action bar APIs stay stable, ActionBarSherlock will no longer be needed once you drop support for Android 2.x devices, perhaps sometime late in 2013.

## Avoid the New on the Old

If the goal is to support new capabilities on new devices, while not losing support for older devices, that implies we have the ability to determine what devices are newer and what devices are older. There are a few techniques for doing this, involving Java and resources.

### Java

If you wish to conditionally execute some lines of code based on what version of Android the device is running, you can check the value of `Build.VERSION`, referring to the `android.os.Build` class. For example:

```
if (Build.VERSION.SDK_INT >= Build.VERSION_CODES.GINGERBREAD) {  
    // do something only on API Level 9 and higher  
}
```

Any device running an older version of Android will skip the statements inside this version guard and therefore will not execute.

That technique is sufficient for Android 2.0 and higher devices. If you are still supporting Android 1.x devices, the story gets a bit more complicated, and that will be discussed later in the book.

If you decide that you want your build target to match your `minSdkVersion` level — as some developers elect to do — your approach will differ. Rather than *blocking* some statements from being executed on *old* devices, you will *enable* some statements to be executed on *new* devices, where those statements use Java reflection (e.g., `Class.forName()`) to reference things that are newer than what your build target supports. Since using reflection is extremely tedious in Java, it is usually simpler to have your build target reflect the classes and methods you are actually using.

### @TargetAPI

One problem with this technique is that Eclipse will grumble at you, saying that you are using classes and methods not available on the API level you set for your `minSdkVersion`. To quiet down these “lint” messages, you can use the `@TargetAPI` annotation.

For example, in the tutorials, we used a `WebViewFragment` back-ported to work with the Android Support version of fragments and `ActionBarSherlock`. `WebViewFragment` wants to pass the `onResume()` and `onPause()` events to the `WebView` it manages, but `onResume()` and `onPause()` only exist on `WebView` on API Level 11 and higher. So, we need to use the `Build` version guard to ensure we do not call those methods on older devices. To get rid of the warning messages, we use `@TargetAPI(11)`:

```
/**  
 * Called when the fragment is visible to the user and actively running. Resumes
```

```
the WebView.
 */
@TargetApi(11)
@Override
public void onPause() {
    super.onPause();

    if (Build.VERSION.SDK_INT >= Build.VERSION_CODES.HONEYCOMB) {
        mWebView.onPause();
    }
}

/**
 * Called when the fragment is no longer resumed. Pauses the WebView.
 */
@TargetApi(11)
@Override
public void onResume() {
    if (Build.VERSION.SDK_INT >= Build.VERSION_CODES.HONEYCOMB) {
        mWebView.onResume();
    }

    super.onResume();
}
}
```

Now, the “lint” capability knows that we are intentionally using API Level 11 capabilities and will no longer warn us about them.

### Another Example: AsyncTask

As mentioned in the chapter on threads, AsyncTask can work with either a full thread pool or a “serialized executor” that will only execute one AsyncTask at a time. From Android 1.6 through 2.3, the full thread pool is the only available option. Android 3.0 introduced the serialized executor, and Android 3.2 made it the default, if you have set your `targetSdkVersion` to be 14 or higher.

If you want to ensure that no matter what your `targetSdkVersion` is, that you always get the full thread pool, you need to use a version guard block:

```
@TargetApi(11)
static public <T> void executeAsyncTask(AsyncTask<T, ?, ?> task,
                                       T... params) {
    if (Build.VERSION.SDK_INT >= Build.VERSION_CODES.HONEYCOMB) {
        task.executeOnExecutor(AsyncTask.THREAD_POOL_EXECUTOR, params);
    }
    else {
        task.execute(params);
    }
}
}
```

Here, we use `executeOnExecutor()` and specifically request the `THREAD_POOL_EXECUTOR` — but only on API Level 11 and higher. Otherwise, we fall back to the default behavior, which gives us the thread pool used on the older API levels.

### Resources

The aforementioned version guards only work for Java code. Sometimes, you will want to have different resources for different versions of Android. For example, you might want to make a custom style that inherits from `Theme.Holo` for Android 3.0 and higher. Since `Theme.Holo` does not exist on earlier versions of Android, trying to use a style that inherits from it will fail miserably on, say, an Android 2.2 device.

To handle this scenario, use the `-vNN` suffix to have two resource sets. One (e.g., `res/values-v11/`) would be restricted to certain Android versions and higher (e.g., API Level 11 and higher). The default resource set (e.g., `res/values/`) would be valid for any device. However, since Android chooses more specific matches first, an Ice Cream Sandwich phone would go with the resources containing the `-v11` suffix. So, in the `-v11` resource directories, you put the resources you want used on API Level 11 and higher, and put the backwards-compatible ones in the set without the suffix. This works for Android 2.0 and higher. You can also use `-v3` for resources that *only* will be used on Android 1.5 (and no higher) or `-v4` for resources that *only* will be used on Android 1.6.

### Components

One variation on the above trick allows you to conditionally enable or disable components, based on API level.

Every `<activity>`, `<receiver>`, or `<service>` in the manifest can support an `android:enabled` attribute. A disabled component (`android:enabled="false"`) cannot be started by anyone, including you.

We have already seen string resources be used in the manifest, for things like `android:label` attributes. Boolean values can also be created as resources. By convention, they are stored in a `bools.xml` file in `res/values/` or related resource sets. Just as `<string>` elements provide the definition of a string resource, `<bool>` elements provide the definition of a boolean resource. Just give the boolean resource a name and a value:

```
<?xml version="1.0" encoding="utf-8"?>
<resources>
  <bool name="on_honeycomb">false</bool>
</resources>
```

The above example has a boolean resource, named `on_honeycomb`, with a value of `false`. That would typically reside in `res/values/bools.xml`. However, you might also have a `res/values-v11/bools.xml` file, where you set `on_honeycomb` to `true`.

Now, you can use `@bool/on_honeycomb` in `android:enabled` to conditionally enable a component for API Level 11 or higher, leaving it disabled for older devices.

This can be a useful trick in cases where you might need multiple separate implementations of a component, based on API level. For example, later in the book we will examine app widgets — those interactive elements users can add to their home screens. App widgets have limited user interfaces, but API Level 11 added a few new capabilities that previously were unavailable, such as the ability to use `ListView`. However, the code for a `ListView`-backed app widget may be substantially different than for a replacement app widget that works on older devices. And, if you leave the `ListView` app widget enabled in the manifest, the user might try choosing it and crashing. So, you would only enable the `ListView` app widget on API Level 11 or higher, using the boolean resource trick.

## Testing

Of course, you will want to make sure your app really does work on older devices as well as newer ones.

At build time, one trick to use periodically is to change your build target to match your `minSdkVersion`, then see where the compiler complains (or, in Eclipse, where you get all the red squiggles). If everything is known (e.g., resource attributes that will be ignored on older versions) or protected (e.g., Java statements inside a version guard `if` statement), then you are OK. If, however, you see complaints about something you forgot was only in newer Android releases, you can take steps to fix things.

You will also want to think about Android versions when it comes to testing, a topic that will be covered later in this book.





# Getting Help

---

Obviously, this book does not cover everything. And while your #1 resource (besides the book) is going to be the Android SDK documentation, you are likely to need information beyond what's covered in either of those places.

Searching online for “android” and a class name is a good way to turn up tutorials that reference a given Android class. However, bear in mind that tutorials written before late August 2008 are probably written for the M5 SDK and, as such, will require considerable adjustment to work properly in current SDKs.

Beyond randomly hunting around for tutorials, though, this chapter outlines some other resources to keep in mind.

## Questions. Sometimes, With Answers.

The “official” places to get assistance with Android are the Android Google Groups. With respect to the SDK, there are three to consider following:

1. StackOverflow's [android](#) tag
2. [android-developers](#), for SDK questions and answers
3. [android-discuss](#), designed for free-form discussion of anything Android-related, not necessarily for programming questions and answers

You might also consider:

1. The core Android team's periodic Hangouts on Google+
2. The Android tutorials and programming forums over at [anddev.org](#)
3. The #android-dev IRC channel on freenode ([irc.freenode.net](#))

It is important, particularly for StackOverflow and the Google Groups, to write well-written questions:

1. Include relevant portions of the source code (e.g., the method in which you are getting an exception)
2. The stack trace from LogCat, if the problem is an unhandled exception
3. On StackOverflow, make sure your source code and stack trace are formatted as source code; on Google Groups, consider posting long listings on [gist.github.com](http://gist.github.com) or a similar sort of code-paste site
4. Explain thoroughly what you are trying to do, how you are trying to do it, and why you are doing it this way (if you think your goal or approach may be a little offbeat)
5. On StackOverflow, respond to answers and comments with your own comments, addressing the person using the @ syntax (e.g., @CommonsWare), to maximize the odds you will get a reply
6. On the Google Groups, do not “ping” or reply to your own message to try to elicit a response until a reasonable amount of time has gone by (e.g., 24 hours)

## Heading to the Source

The source code to Android is now available. Mostly this is for people looking to enhance, improve, or otherwise fuss with the insides of the Android operating system. But, it is possible that you will find the answers you seek in that code, particularly if you want to see how some built-in Android component “does its thing”.

The source code and related resources can be found at <http://source.android.com>. Here, you can:

1. [Download](#) the source code
2. File [bug reports](#) against the operating system itself
3. [Submit patches](#) and learn about the process for how such patches get evaluated and approved
4. Join a separate set of [Google Groups](#) for Android platform development

Note that, as of the time of this writing, you cannot browse or search the Android source code from the Android project’s site. The easiest way to browse the source code is to browse [the GitHub mirrors of the source](#). To search the source code, you can use services like [AndroidXRef](#).

## Getting Your News Fix

Ed Burnette, a nice guy who happened to write his own Android book, is also the manager of [Planet Android](#), a feed aggregator for a number of Android-related blogs. Subscribing to the planet's feed will let you monitor quite a bit of Android-related blog posts, though not exclusively related to programming.



# Introducing GridLayout

---

In 2011, Google added `GridLayout` to our roster of available container classes (a.k.a., layout managers). `GridLayout` is an attempt to make setting up complex Android layouts a bit easier, particularly with an eye towards working well with the Eclipse graphical layout editor. In this chapter, we will examine why `GridLayout` was added and how we can use it in our projects.

## Prerequisites

Understanding this chapter requires that you have read the core chapters of this book.

## Issues with the Classic Containers

Once upon a time, most layouts were implemented using a combination of `LinearLayout`, `RelativeLayout`, and `TableLayout`. In fact, most layouts are still created using those three “classic” containers. Almost everything you would want to be able to create can be accomplished using one, or sometimes more than one, of those containers.

However, there are issues with the classic containers. The two most prominent might be the over-reliance upon nested containers and issues with Eclipse’s drag-and-drop GUI building capability.

### Nested Containers

`LinearLayout` and `TableLayout` suffer from a tendency to put too many containers inside of other containers. For example, implementing some sort of 2x2 grid would involve:

- A vertical `LinearLayout` holding onto a pair of horizontal `LinearLayout`s, or
- A `TableLayout` holding onto a pair of `TableRows`

On the surface, this does not seem that bad. And, in many cases, it is not that bad.

However, views and containers are relatively heavyweight items. They consume a fair bit of heap space, and when it comes time to lay them out on the screen, they consume a fair bit of processing power. In particular, the fact that a container can hold onto *any* type of widget or container means that it is difficult to optimize common scenarios (e.g., a 2x2 grid) for faster processing. Instead, a container treats its children more or less as “black boxes”, requiring lots of method invocations up and down the call stack to calculate sizes and complete the layout process.

Moreover, the call stack itself can be an issue. The stack size of the main application thread has historically been rather small (8KB was the last reported value). If you have a complex UI, with more than ~15 nested containers, you are likely to run into an `StackOverflowError`. Android itself will contribute some of these containers, exacerbating this problem.

`RelativeLayout`, by comparison, can implement some UI patterns without any nested containers, simply by positioning widgets relative to the container’s bounds and relative to each other.

### Eclipse Drag-and-Drop

Where `RelativeLayout` falls down is with the drag-and-drop capability of the graphical layout editor in Eclipse.

When you release the mouse button when dropping a widget into the preview area, the tools need to determine what that really means in terms of layout rules.

`LinearLayout` works fairly well: it will either insert your widget in between two other widgets or add it to the end of the row or column you dropped into. `TableLayout` behaves similarly.

`RelativeLayout`, though, has a more difficult time guessing what particular combination of rules you really mean by this particular drop target. Are you trying to attach the widget to another widget? If so, which one? Are you trying to attach the widget to the bounds of the `RelativeLayout`? While sometimes it will guess properly, sometimes it will not, with potentially confusing results. It is reasonably likely that you will need to tweak the layout rules manually, either via the Properties pane or via the raw XML.

## The New Contender: `GridLayout`

`GridLayout` tries to cull the best of the capabilities of the classic containers and drop as many of their limitations as possible.

`GridLayout` works a bit like `TableLayout`, insofar as it sets things up in a grid, with rows and columns, where the row and column sizes are computed based upon what is placed into those rows and columns. However, unlike `TableLayout`, which relies upon a separate `TableRow` container to manage the rows, `GridLayout` takes the `RelativeLayout` approach of putting rules on the individual widgets (or containers) in the grid, where those rules steer the layout processing. For example, with `GridLayout`, widgets can declare specifically which row and column they should slot into.

`GridLayout` also goes a bit beyond what `TableLayout` offers in terms of capabilities. Notably, it supports row spans as well as column spans, whereas `TableRow` only supports a column span. This gives you greater flexibility when designing your layout to fit the grid-style positioning rules. You can also:

- Explicitly state how many columns there are, rather than having that value be inferred by row contents
- Allow Android to determine where to place a widget without specifying any row or column, with it finding the next available set of grid cells capable of holding the widget, based upon its requested row span and column span values
- Have control over orientation: whereas `TableLayout` always was a column of rows, you could have a `GridLayout` be a row of columns, if that makes implementing the design easier
- And so on



Alas, Eclipse is beyond hopeless with GridLayout at this junction. With luck, it will improve in future years. In the interim, you will most likely need to spend quality time in the XML editor in order to get the results that you want.

## GridLayout and the Android Support Package

GridLayout was natively added to the Android SDK in API Level 14 (Android 4.0). Fortunately, the Android Support package has a backport of GridLayout. However, the backport is not in one of the JAR files, such as `android-support-v4.jar`, as GridLayout requires some resources. Hence, it is in an Android library project that you must add to your project.

You will find this library project in `$SDK/extras/android/support/v7/GridLayout`, where `$SDK` is wherever you installed your copy of the Android SDK.

Command-line builds can use `android update lib-project` to attach the Android library project to their host project. Eclipse developers will need to create a new Eclipse project based upon the Android library project first. In either case, the process is similar to what was needed to add ActionBarSherlock to a project, as was described [in one of the tutorials](#).

When using the backported GridLayout, you will need to declare another XML namespace in your layout XML resources. That namespace will be `http://schemas.android.com/apk/res/your.package.goes.here`, where `your.package.goes.here` is replaced by your application's package name. If you use Eclipse to add the GridLayout to the layout resource, it will automatically add this namespace, under the prefix of `app`, such as:

```
<android.support.v7.widget.GridLayout
  xmlns:android="http://schemas.android.com/apk/res/android"
  xmlns:app="http://schemas.android.com/apk/res/
com.commonware.android.gridlayout"
  android:layout_width="fill_parent"
  android:layout_height="fill_parent"
  app:columnCount="2">
</android.support.v7.widget.GridLayout>
```

That namespace is required for GridLayout-specific attributes. For example, we can have a `columnCount` attribute, indicating how many columns the GridLayout should contain. For the native API Level 14 GridLayout, that attribute would be `android:columnCount`. For the backport, it will be `app:columnCount`, assuming that you gave the namespace the prefix of `app`.

---

## INTRODUCING GRIDLAYOUT

---

When citing `GridLayout`-specific attributes, the rest of this chapter will use the `app` prefix, to clarify which attributes need that prefix for the backport. If you are using the native API Level 14 implementation of `GridLayout`, and you are manually working with the XML, just remember to use `android` as a prefix instead of `app`.

The sample app shows *both* the native and the backport implementations of `GridLayout`: on API Level 14+ devices/emulators it will use native implementations from `res/layout-v14/`, and it will use the backport on older environments.

## Eclipse and GridLayout

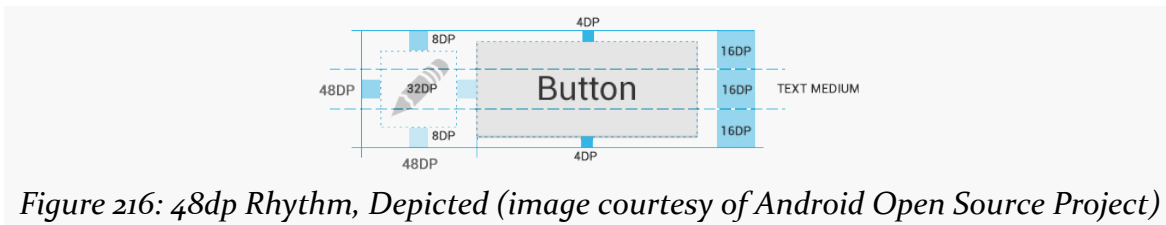
You will find `GridLayout` in the “Layouts” portion of the palette of available widgets and containers. As with anything else, you can drag it from the palette into the preview area, then use the Outline and Properties views to configure it.

However, this is the native API Level 14 version of `GridLayout`, not the backport. If you wish to use the backport, you will need to go into the XML and manually adjust the element name, to be `android.support.v7.widget.GridLayout` instead of `GridLayout`. This may, in turn, require restarting Eclipse to make it happy, if you get errors in the preview area when trying to view the resulting `GridLayout`.

In some future edition of this book, when Eclipse editing of `GridLayout` is sensible, we will describe the process of using it to create the various layouts that appear in the rest of this chapter.

## Trying to Have Some Rhythm

One of the things that the Android design guidelines try to emphasize is having everything work in 48dp-high blocks, to give you a reasonable set of touch targets for fingers, while maintaining some uniformity of sizing.



*Figure 216: 48dp Rhythm, Depicted (image courtesy of Android Open Source Project)*

When working with `GridLayout` in the Eclipse graphical layout editor, you will be prompted to try to put your widgets in 48dp-based positions. There is even a “snap

to grid” toolbar toggle button that, when pressed, will force everything you drag into the GridLayout to reside on a 16dp-based grid.

To accomplish this, it adds a series of Space widgets to your layout (or, if you are working with the backport of GridLayout, you get `android.support.v7.widget.Space` widgets). These will consume the space that gets your widgets to line up in what Eclipse thinks is the proper positioning. We will see examples of that as we examine our sample application.

## Our Test App

To look at a series of GridLayout-based layouts, let’s turn our attention to the [GridLayout/Sampler](#) sample project. This has the same ViewPager and PagerTabStrip as did the second sample app from [the chapter on ViewPager](#). However, rather than use a list of 10 EditText widgets managed by fragments, in this case, our fragments will manage layouts containing GridLayout. Each page of our pager will contain a TrivialFragment, whose contents are based on a Sample class that is a simple pair of a layout resource ID and a string resource ID for the fragment’s title:

```
package com.commonware.android.gridlayout;

class Sample {
    int layoutId;
    int titleId;

    Sample(int layoutId, int titleId) {
        this.layoutId=layoutId;
        this.titleId=titleId;
    }
}
```

Our revised SampleAdapter maintains a static ArrayList of these Sample objects, one per layout we wish to examine, and uses those values to populate our ViewPager title:

```
package com.commonware.android.gridlayout;

import android.content.Context;
import android.support.v4.app.Fragment;
import android.support.v4.app.FragmentManager;
import android.support.v4.app.FragmentPagerAdapter;
import java.util.ArrayList;

public class SampleAdapter extends FragmentPagerAdapter {
```

## INTRODUCING GRIDLAYOUT

---

```
static ArrayList<Sample> SAMPLES=new ArrayList<Sample>();
private Context ctxt=null;

static {
    SAMPLES.add(new Sample(R.layout.row, R.string.row));
    SAMPLES.add(new Sample(R.layout.column, R.string.column));
    SAMPLES.add(new Sample(R.layout.table, R.string.table));
    SAMPLES.add(new Sample(R.layout.table_flex, R.string.flexible_table));
    SAMPLES.add(new Sample(R.layout.implicit, R.string.implicit));
    SAMPLES.add(new Sample(R.layout.spans, R.string.spans));
}

public SampleAdapter(Context ctxt, FragmentManager mgr) {
    super(mgr);
    this.ctxt=ctxt;
}

@Override
public int getCount() {
    return(SAMPLES.size());
}

@Override
public Fragment getItem(int position) {
    return(TrivialFragment.newInstance(getSample(position).layoutId));
}

@Override
public String getPageTitle(int position) {
    return(ctxt.getString(getSample(position).titleId));
}

private Sample getSample(int position) {
    return(SAMPLES.get(position));
}
}
```

TrivialFragment just inflates our desired layout, having received the layout resource ID as a parameter to its factory method:

```
package com.commonware.android.gridlayout;

import android.os.Bundle;
import android.view.LayoutInflater;
import android.view.View;
import android.view.ViewGroup;
import com.actionbarsherlock.app.SherlockFragment;

public class TrivialFragment extends SherlockFragment {
    private static final String KEY_LAYOUT_ID="layoutId";

    static TrivialFragment newInstance(int layoutId) {
        TrivialFragment frag=new TrivialFragment();
    }
}
```

```
Bundle args=new Bundle();

args.putInt(KEY_LAYOUT_ID, layoutId);
frag.setArguments(args);

return(frag);
}

@Override
public View onCreateView(LayoutInflater inflater,
    ViewGroup container,
    Bundle savedInstanceState) {
    return(inflater.inflate(getArguments().getInt(KEY_LAYOUT_ID, -1),
        container, false));
}
}
```

Note that if you load this project from the GitHub repository, you will need to update it not only for ActionBarSherlock, but also for your copy of the GridLayout library project.

## Replacing the Classics

Let's first examine the behavior of GridLayout by seeing how it can replace some of the classic layouts we would get from LinearLayout and TableLayout. Each of the following sub-sections will examine one GridLayout-based layout XML resource, how it can be constructed, and what the result looks like when viewed in the sample project.

### Horizontal LinearLayout

The classic way to create a row of widgets is to use a horizontal LinearLayout. The LinearLayout will put each of its children, one after the next, within the row.

The GridLayout equivalent is to specify one that has an `app:columnCount` equal to the number of widgets in the row. Then, each widget will have `app:layout_column` set to its specific column index (starting at 0) and `app:layout_row` set to 0, as seen in `res/layout/row.xml`:

```
<android.support.v7.widget.GridLayout xmlns:android="http://schemas.android.com/
apk/res/android"
    xmlns:app="http://schemas.android.com/apk/res/
com.commonware.android.gridlayout"
    android:layout_width="fill_parent"
    android:layout_height="fill_parent"
    app:columnCount="2">
```

## INTRODUCING GRIDLAYOUT

---

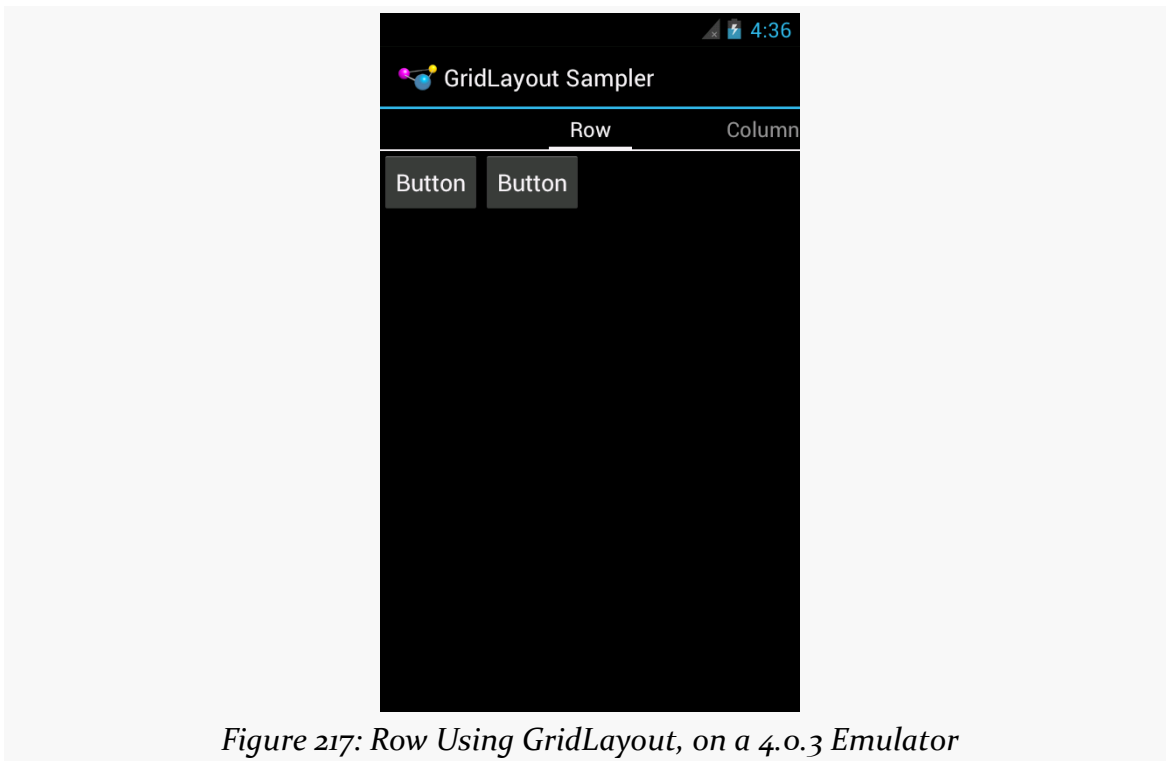
```
<Button
  app:layout_column="0"
  app:layout_row="0"
  android:text="@string/button"/>

<Button
  app:layout_column="1"
  app:layout_row="0"
  android:text="@string/button"/>

</android.support.v7.widget.GridLayout>
```

Unlike `LinearLayout`, though, we do not specify sizes of the children, in terms of `android:layout_width` and `android:layout_height`. `GridLayout` works a bit like `TableLayout` in this regard, supplying default values for these attributes. In the case of `GridLayout`, the defaults are `wrap_content`, and this cannot be overridden (akin to the behavior of immediate children of a `TableRow`). Instead, you will control size via row and column spans, as will be illustrated later in this chapter.

Given the above layout, we get:



*Figure 217: Row Using GridLayout, on a 4.0.3 Emulator*

### Vertical LinearLayout

Similarly, the conventional way you would specify a column is to use a vertical LinearLayout, which would position its children one after the next. The GridLayout equivalent would be to have `app:columnCount` set to 1, and to place the widgets in each required row via `app:layout_row` attributes, as seen in `res/layout/column.xml`:

```
<android.support.v7.widget.GridLayout xmlns:android="http://schemas.android.com/apk/res/android"
  xmlns:app="http://schemas.android.com/apk/res/com.commonware.android.gridlayout"
  android:layout_width="fill_parent"
  android:layout_height="fill_parent"
  app:columnCount="1">

  <Button
    app:layout_column="0"
    app:layout_row="0"
    android:text="@string/button"/>

  <Button
    app:layout_column="0"
    app:layout_row="1"
    android:text="@string/button"/>

</android.support.v7.widget.GridLayout>
```

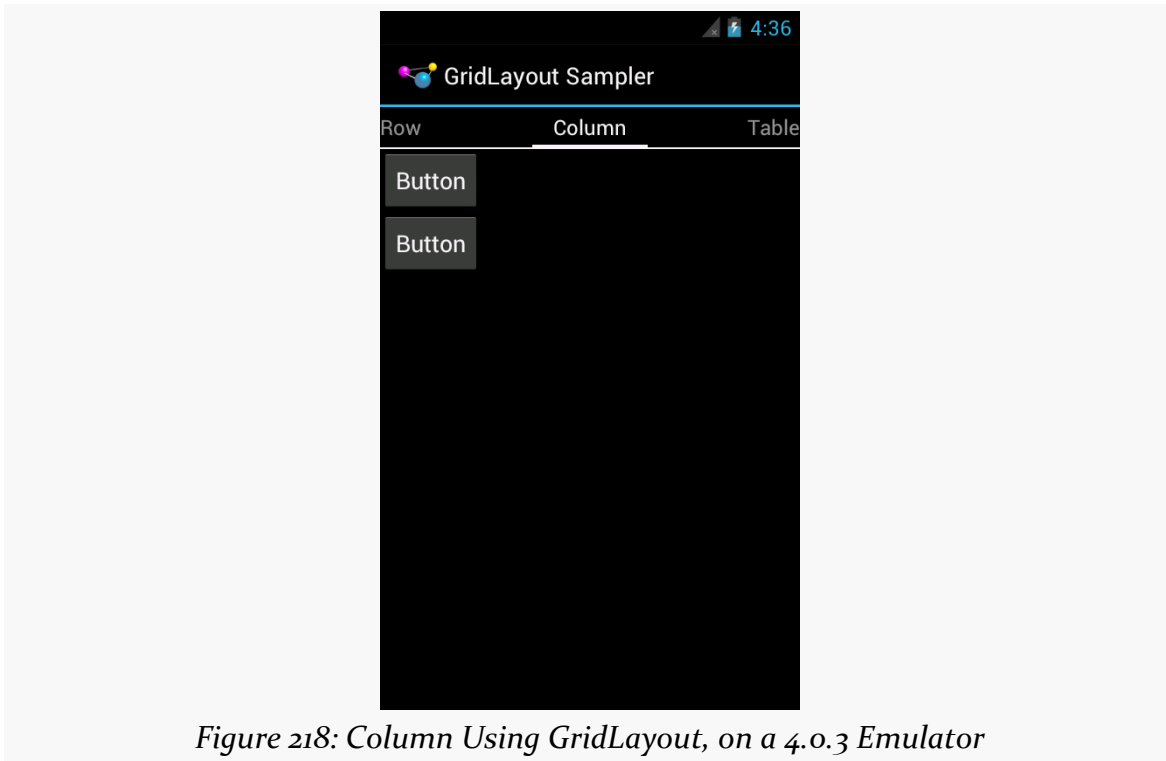


Figure 218: Column Using GridLayout, on a 4.0.3 Emulator

All that being said, it is still probably better to use `LinearLayout` in these cases, rather than mess with `GridLayout`.

### TableLayout

The big key to a `TableLayout` is column width, where columns expand to fill their contents, assuming there is sufficient room in the table. `GridLayout` also expands its columns to address the sizes of its contents.

For example, here is a simple 2x2 table, with `TextView` widgets in the left column and `EditText` widgets in the right column, as seen in `res/layout/table.xml`:

```
<android.support.v7.widget.GridLayout xmlns:android="http://schemas.android.com/apk/res/android"
  xmlns:app="http://schemas.android.com/apk/res/com.commonware.android.gridlayout"
  android:layout_width="fill_parent"
  android:layout_height="fill_parent"
  app:columnCount="2">

  <TextView
    app:layout_column="0"
```



## INTRODUCING GRIDLAYOUT

---

```
app:layout_row="0"
android:text="@string/name"
android:textAppearance="?android:attr/textAppearanceLarge"/>

<EditText
app:layout_column="1"
app:layout_row="0"
android:inputType="textPersonName">

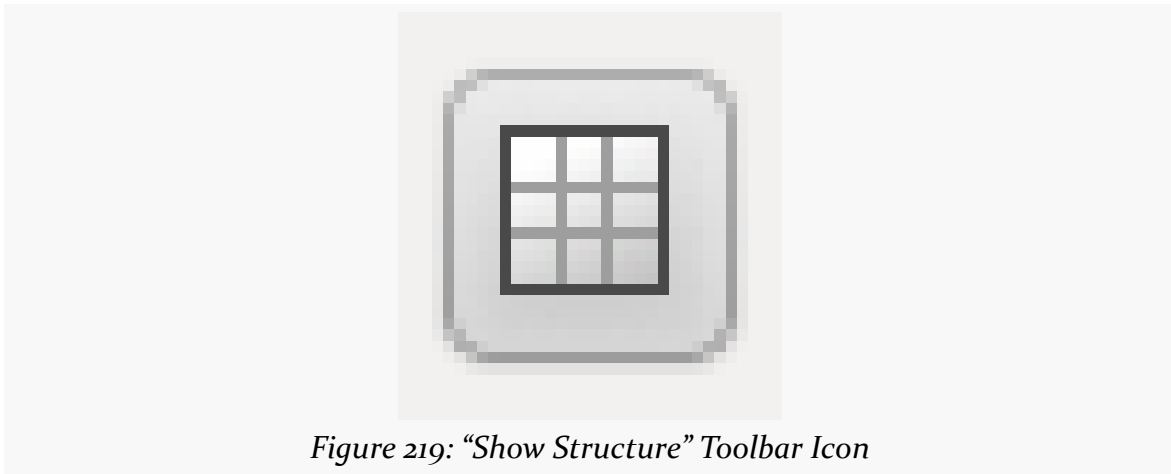
    <requestFocus/>
</EditText>

<TextView
app:layout_column="0"
app:layout_row="1"
android:text="@string/address"
android:textAppearance="?android:attr/textAppearanceLarge"/>

<EditText
app:layout_column="1"
app:layout_row="1"
android:inputType="textPostalAddress"/>

</android.support.v7.widget.GridLayout>
```

One feature of the Eclipse graphical layout editor is that we can toggle on a series of lines showing the sizing of the rows and columns, by clicking the “Show Structure” toolbar button:



This helps illustrate that our right column actually takes up all remaining room on the screen, by showing green gridlines denoting the transitions between rows and columns:

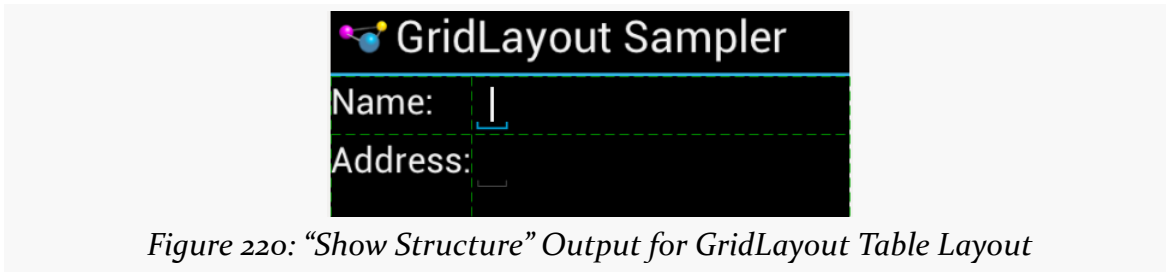


Figure 220: “Show Structure” Output for GridLayout Table Layout

However, our EditText widgets are small, because nothing is causing them to fill the available space. To do that, we can use `android:layout_gravity`, to ask the GridLayout to let the widgets fill the available horizontal space, as seen in `res/layout/table_flex.xml`:

```
<android.support.v7.widget.GridLayout xmlns:android="http://schemas.android.com/apk/res/android"
  xmlns:app="http://schemas.android.com/apk/res/com.commonware.android.gridlayout"
  android:layout_width="fill_parent"
  android:layout_height="fill_parent"
  app:columnCount="2">

  <TextView
    app:layout_column="0"
    app:layout_row="0"
    android:text="@string/name"
    android:textAppearance="?android:attr/textAppearanceLarge"/>

  <EditText
    app:layout_column="1"
    app:layout_row="0"
    app:layout_gravity="fill_horizontal"
    android:inputType="textPersonName">

    <requestFocus/>
  </EditText>

  <TextView
    app:layout_column="0"
    app:layout_row="1"
    android:text="@string/address"
    android:textAppearance="?android:attr/textAppearanceLarge"/>

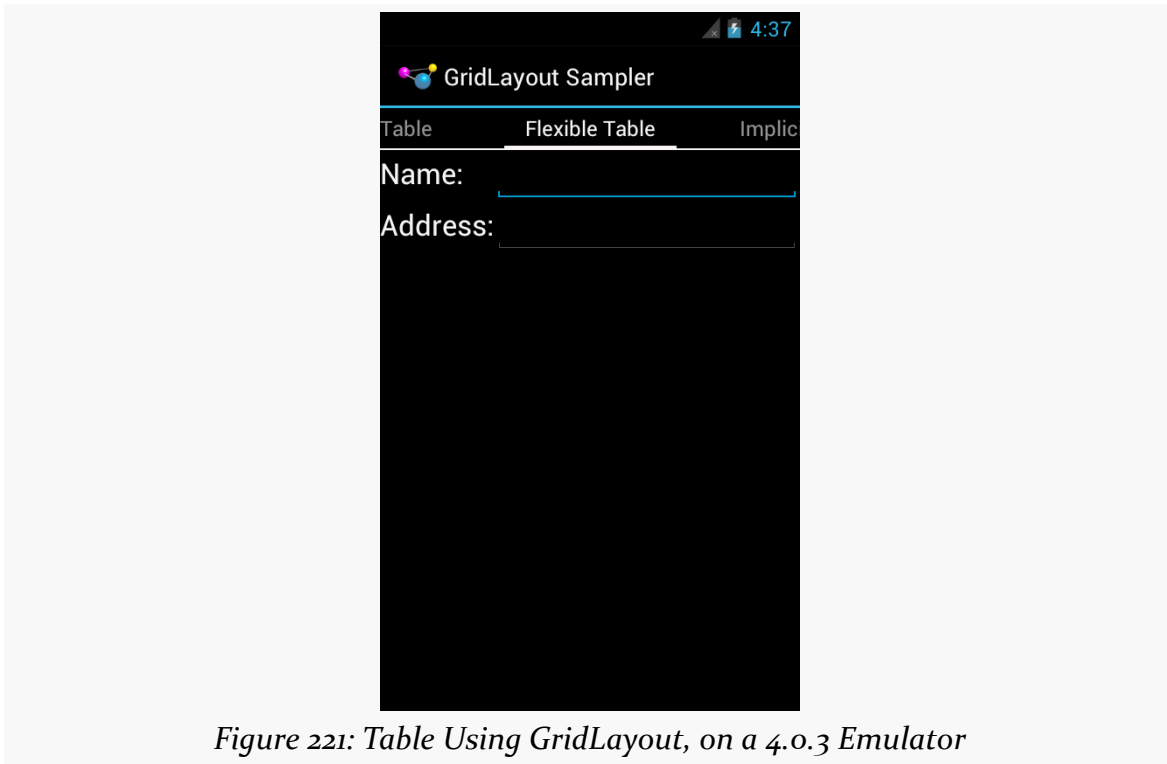
  <EditText
    app:layout_column="1"
    app:layout_row="1"
    app:layout_gravity="fill_horizontal"
    android:inputType="textPostalAddress"/>

</android.support.v7.widget.GridLayout>
```

## INTRODUCING GRIDLAYOUT

---

This allows the EditText widgets to fill the width of the column:



*Figure 221: Table Using GridLayout, on a 4.0.3 Emulator*

That holds true regardless of how wide that column is:

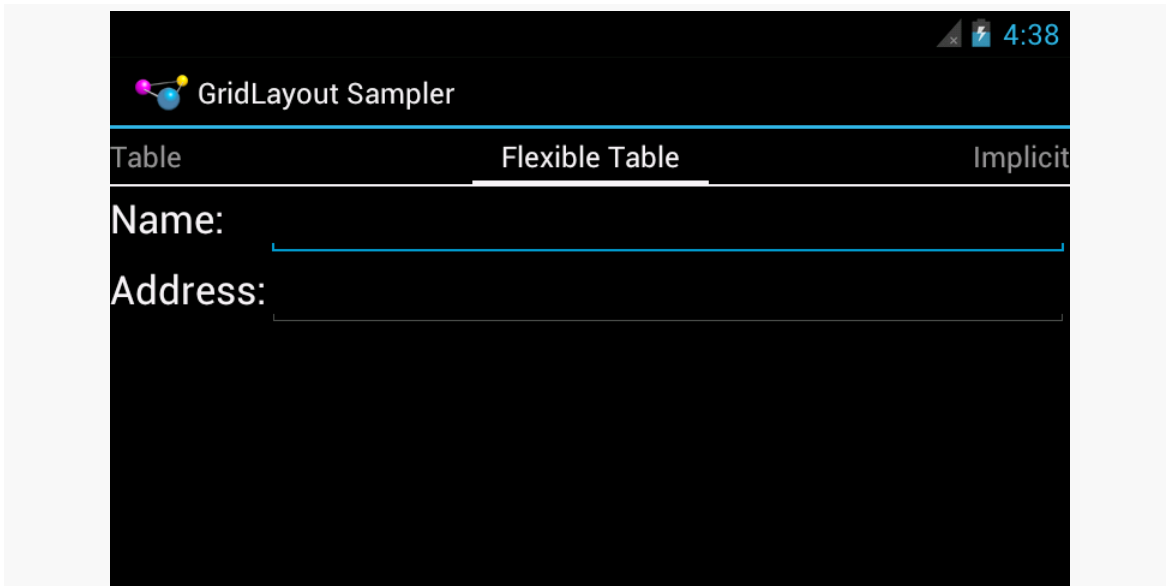


Figure 222: Table Using GridLayout, in Landscape, on a 4.0.3 Emulator

## Implicit Rows and Columns

While all the previous samples showed the row and column of each widget being defined explicitly via `app:layout_row` and `app:layout_column` attributes, that is not your only option.

If you have `app:columnCount` on the `GridLayout` element itself, you can allow `GridLayout` to assign rows and columns. In this respect, `GridLayout` behaves a bit like a “flow layout”: it assigns widgets to cells in the first row, starting from the first column and working its way across, wrapping to the next row when it runs out of room. This makes for a more terse layout file, at the cost of perhaps introducing a bit of confusion when you add or remove a widget and everything after it in the layout file shifts location.

For example, `res/layout/implicit.xml` is the same as `res/layout/table_flex.xml`, except that it skips the `app:layout_row` and `app:layout_column` attributes, allowing `GridLayout` to assign the positions:

```
<android.support.v7.widget.GridLayout xmlns:android="http://schemas.android.com/apk/res/android"
    xmlns:app="http://schemas.android.com/apk/res/com.commonware.android.gridlayout"
    android:layout_width="fill_parent"
    android:layout_height="fill_parent"
```

## INTRODUCING GRIDLAYOUT

---

```
app:columnCount="2"
app:orientation="horizontal">

<TextView
    android:text="@string/name"
    android:textAppearance="?android:attr/textAppearanceLarge"/>

<EditText
    app:layout_gravity="fill_horizontal"
    android:inputType="textPersonName">

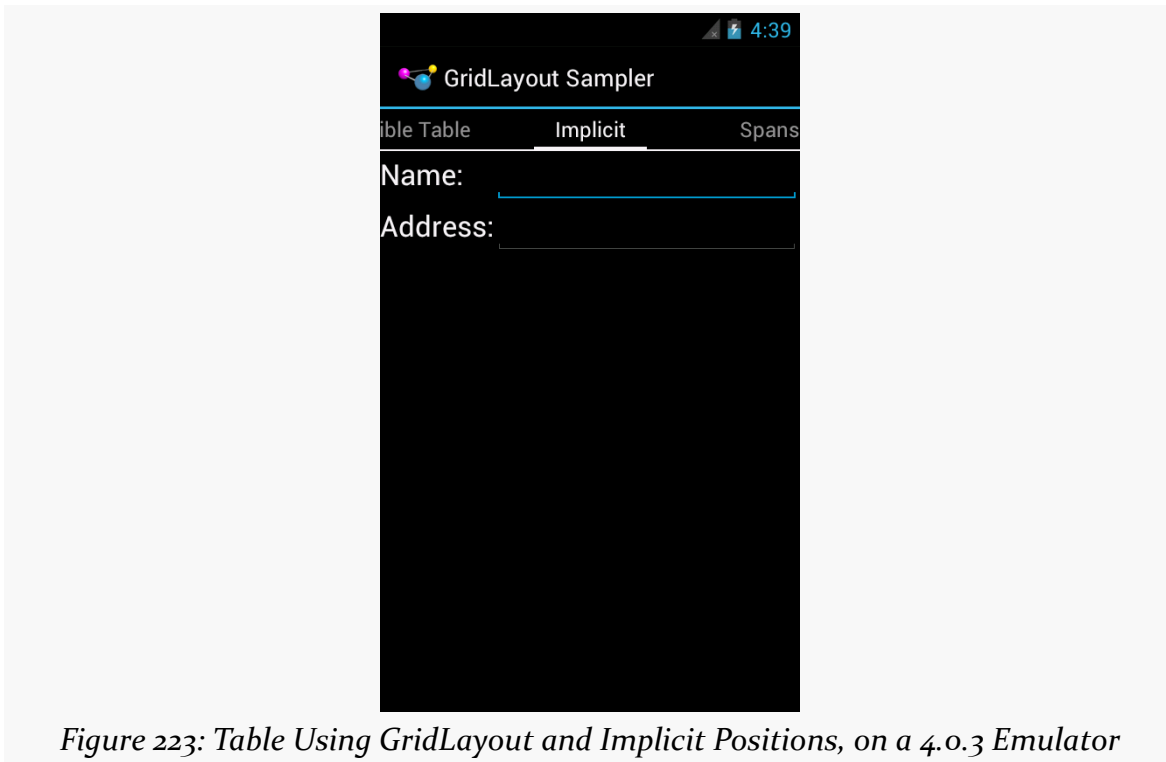
    <requestFocus/>
</EditText>

<TextView
    android:text="@string/address"
    android:textAppearance="?android:attr/textAppearanceLarge"/>

<EditText
    app:layout_gravity="fill_horizontal"
    android:inputType="textPostalAddress"/>

</android.support.v7.widget.GridLayout>
```

Visually, this sample is identical to the last one:



*Figure 223: Table Using GridLayout and Implicit Positions, on a 4.0.3 Emulator*

The “across columns, then down rows” model holds for `GridLayout` in the default orientation: horizontal. You can add an `app:orientation` attribute to the `GridLayout`, setting it to vertical. Then, based on an `app:rowCount` value, `GridLayout` will automatically assign positions, working down the first column, then across to the next column when it runs out of rows.

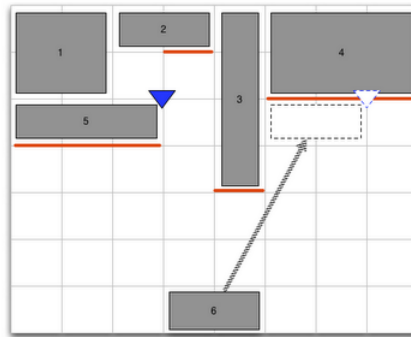
## Row and Column Spans

Like `TableLayout`, `GridLayout` supports the notion of column spans. You can use `app:layout_columnSpan` to indicate how many columns a particular widget should span in the resulting grid.

However, `GridLayout` also supports row spans, in the form of `app:layout_rowSpan` attributes. A widget can span rows, columns, or both, as needed.

If you are using implicit positions, per the previous section, `GridLayout` will seek the next available space that has sufficient rows and columns for a widget’s set of spans.

For example, the following diagram depicts five buttons placed in a `GridLayout` with various spans, and an attempt to add a sixth button that should span two columns:



*Figure 224: Span Sample (image courtesy of Android Open Source Project)*

Assuming the first five buttons were added in sequence and with implicit positioning, `GridLayout` ordinarily would drop the sixth button into the fourth column of the third row. However, there is only a one-column-wide space available there, given that the third button intrudes into the third row. Hence, `GridLayout` will skip over the smaller space and put the sixth button into the sixth column in the third row.

## INTRODUCING GRIDLAYOUT

---

A GridLayout-based layout that implements the above diagram can be found in `res/layout/spans.xml`:

```
<android.support.v7.widget.GridLayout xmlns:android="http://schemas.android.com/apk/res/android"
  xmlns:app="http://schemas.android.com/apk/res/com.commonware.android.gridlayout"
  android:layout_width="fill_parent"
  android:layout_height="fill_parent"
  app:columnCount="9"
  app:orientation="horizontal"
  app:rowCount="5">

  <Button
    app:layout_gravity="fill"
    app:layout_columnSpan="2"
    app:layout_rowSpan="2"
    android:text="@string/string_1"/>

  <Button
    app:layout_gravity="fill_horizontal"
    app:layout_columnSpan="2"
    android:text="@string/string_2"/>

  <Button
    app:layout_gravity="fill_vertical"
    app:layout_rowSpan="4"
    android:text="@string/string_3"/>

  <Button
    app:layout_gravity="fill"
    app:layout_columnSpan="3"
    app:layout_rowSpan="2"
    android:text="@string/string_4"/>

  <Button
    app:layout_gravity="fill_horizontal"
    app:layout_columnSpan="3"
    android:text="@string/string_5"/>

  <Button
    app:layout_gravity="fill_horizontal"
    app:layout_columnSpan="2"
    android:text="@string/string_6"/>

  <android.support.v7.widget.Space
    android:layout_width="36dp"
    app:layout_column="0"
    app:layout_row="4"/>

  <android.support.v7.widget.Space
    android:layout_width="36dp"
    app:layout_column="1"
```

## INTRODUCING GRIDLAYOUT

---

```
    app:layout_row="4"/>

<android.support.v7.widget.Space
    android:layout_width="36dp"
    app:layout_column="2"
    app:layout_row="4"/>

<android.support.v7.widget.Space
    android:layout_width="36dp"
    app:layout_column="3"
    app:layout_row="4"/>

<android.support.v7.widget.Space
    android:layout_width="36dp"
    app:layout_column="4"
    app:layout_row="4"/>

<android.support.v7.widget.Space
    android:layout_width="36dp"
    app:layout_column="5"
    app:layout_row="4"/>

<android.support.v7.widget.Space
    android:layout_width="36dp"
    app:layout_column="6"
    app:layout_row="4"/>

<android.support.v7.widget.Space
    android:layout_width="36dp"
    app:layout_column="7"
    app:layout_row="4"/>

<android.support.v7.widget.Space
    android:layout_height="36dp"
    android:layout_column="8"
    android:layout_row="0"/>

<android.support.v7.widget.Space
    android:layout_height="36dp"
    app:layout_column="8"
    app:layout_row="1"/>

<android.support.v7.widget.Space
    android:layout_height="36dp"
    app:layout_column="8"
    app:layout_row="2"/>

<android.support.v7.widget.Space
    android:layout_height="36dp"
    app:layout_column="8"
    app:layout_row="3"/>

<android.support.v7.widget.Space
    android:layout_height="36dp"
```



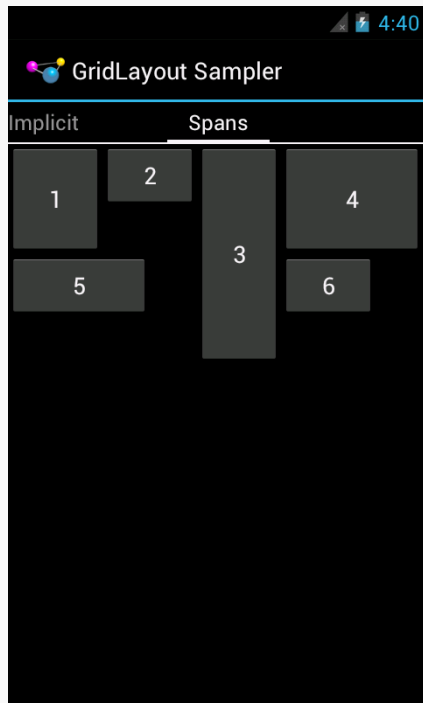
## INTRODUCING GRIDLAYOUT

---

```
app:layout_column="8"  
app:layout_row="4"/>
```

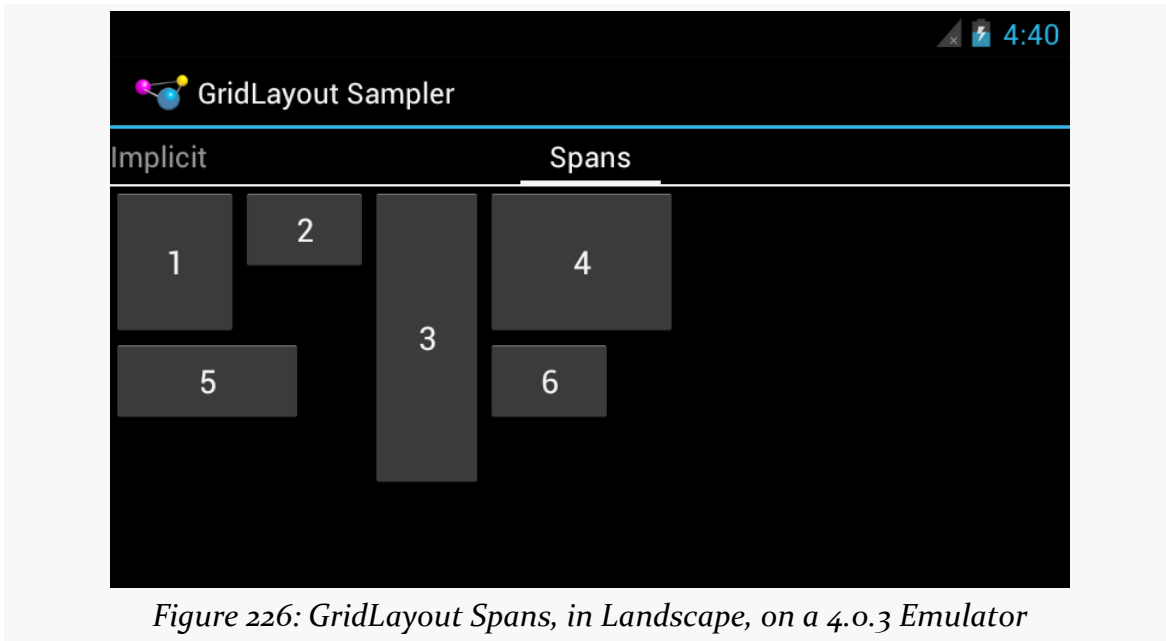
```
</android.support.v7.widget.GridLayout>
```

This layout shows one of the limitations of `GridLayout`: its columns and rows will have a size of 0 by default. Hence, to ensure that each row and column has a minimum size, this layout uses `Space` elements (in an eighth column and fifth row) to establish those minimums. This makes the layout file fairly verbose, but it gives the desired results:



*Figure 225: GridLayout Spans, on a 4.0.3 Emulator*

However, the fixed-sized `Space` elements break the fluidity of the layout:



*Figure 226: GridLayout Spans, in Landscape, on a 4.0.3 Emulator*

Perhaps someday someone will create a PercentSpace widget, occupying a percentage of the parent's size, that could be used instead.

The author would like to give thanks to [those on StackOverflow who assisted in getting the span layout to work](#).

## Should You Use GridLayout?

An [Android Developers Blog post on GridLayout](#) says:

If you are starting a UI from scratch and are not familiar with Android layouts, use a GridLayout — it supports most of the features of the other layouts and has a simpler and more general API than either TableLayout or RelativeLayout.

In 2014, that may be a sound recommendation for newcomers to Android, and it might not be an unreasonable suggestion for experienced Android developers today. However, the complexity of the Android library project required for the backport, coupled with the copious number of examples using the classic layout managers, make those older layout managers a better choice in many respects for those with limited Android experience.



# Dialogs and DialogFragments

---

Generally speaking, modal dialogs are considered to offer poor UX, particularly on mobile devices. You want to give the user more choices, not fewer, and so locking them into “deal with this dialog right now, or else” is not especially friendly. That being said, from time to time, there will be cases where that sort of modal interface is necessary, and to help with that, Android does have a dialog framework that you can use.

## Prerequisites

Understanding this chapter requires that you have read the core chapters of this book.

## DatePickerDialog and TimePickerDialog

Android has a pair of built-in dialogs that handle the common operations of allowing the user to select a date (`DatePickerDialog`) or a time (`TimePickerDialog`). These are simply dialog wrappers around the [DatePicker](#) and [TimePicker](#) widgets, as are described in this book’s Widget Catalog.

The `DatePickerDialog` allows you to set the starting date for the selection, in the form of a year, month, and day of month value. Note that the month runs from 0 for January through 11 for December. Most importantly, both let you provide a callback object (`OnDateChangeListener` or `OnDateSetListener`) where you are informed of a new date selected by the user. It is up to you to store that date someplace, particularly if you are using the dialog, since there is no other way for you to get at the chosen date later on.

Similarly, `TimePickerDialog` lets you:

- Set the initial time the user can adjust, in the form of an hour (0 through 23) and a minute (0 through 59)
- Indicate if the selection should be in 12-hour mode with an AM/PM toggle, or in 24-hour mode (what in the US is thought of as “military time” and much of the rest of the world is thought of as “the way times are supposed to be”)
- Provide a callback object (`OnTimeChangeListener` or `OnTimeSetListener`) to be notified of when the user has chosen a new time, which is supplied to you in the form of an hour and minute

For example, from the [Dialogs/Chrono](#) sample project, here’s a trivial layout containing a label and two buttons — the buttons will pop up the dialog flavors of the date and time pickers:

```
<?xml version="1.0" encoding="utf-8"?>
<LinearLayout
  xmlns:android="http://schemas.android.com/apk/res/android"
  android:orientation="vertical"
  android:layout_width="fill_parent"
  android:layout_height="fill_parent"
  >
  <TextView android:id="@+id/dateAndTime"
    android:layout_width="fill_parent"
    android:layout_height="wrap_content"
    />
  <Button android:id="@+id/dateBtn"
    android:layout_width="fill_parent"
    android:layout_height="wrap_content"
    android:text="Set the Date"
    android:onClick="chooseDate"
    />
  <Button android:id="@+id/timeBtn"
    android:layout_width="fill_parent"
    android:layout_height="wrap_content"
    android:text="Set the Time"
    android:onClick="chooseTime"
    />
</LinearLayout>
```

The more interesting stuff comes in the Java source:

```
package com.commonware.android.chrono;

import android.app.Activity;
import android.app.DatePickerDialog;
import android.app.TimePickerDialog;
```

## DIALOGS AND DIALOGFRAGMENTS

---

```
import android.os.Bundle;
import android.text.format.DateUtils;
import android.view.View;
import android.widget.DatePicker;
import android.widget.TextView;
import android.widget.TimePicker;
import java.util.Calendar;

public class ChronoDemo extends Activity {
    TextView dateAndTimeLabel;
    Calendar dateAndTime=Calendar.getInstance();

    @Override
    public void onCreate(Bundle icle) {
        super.onCreate(icle);
        setContentView(R.layout.main);

        dateAndTimeLabel=(TextView)findViewById(R.id.dateAndTime);

        updateLabel();
    }

    public void chooseDate(View v) {
        new DatePickerDialog(ChronoDemo.this, d,
            dateAndTime.get(Calendar.YEAR),
            dateAndTime.get(Calendar.MONTH),
            dateAndTime.get(Calendar.DAY_OF_MONTH))

            .show();
    }

    public void chooseTime(View v) {
        new TimePickerDialog(ChronoDemo.this, t,
            dateAndTime.get(Calendar.HOUR_OF_DAY),
            dateAndTime.get(Calendar.MINUTE),
            true)

            .show();
    }

    private void updateLabel() {
        dateAndTimeLabel
            .setText(DateUtils
                .formatDateTime(this,
                    dateAndTime.getTimeInMillis(),
DateUtils.FORMAT_SHOW_DATE|DateUtils.FORMAT_SHOW_TIME));
    }

    DatePickerDialog.OnDateSetListener d=new DatePickerDialog.OnDateSetListener() {
        public void onDateSet(DatePicker view, int year, int monthOfYear,
            int dayOfMonth) {
            dateAndTime.set(Calendar.YEAR, year);
            dateAndTime.set(Calendar.MONTH, monthOfYear);
            dateAndTime.set(Calendar.DAY_OF_MONTH, dayOfMonth);
            updateLabel();
        }
    }
}
```

```
    }  
};  
  
TimePickerDialog.OnTimeSetListener t=new TimePickerDialog.OnTimeSetListener() {  
    public void onTimeSet(TimePicker view, int hourOfDay,  
        int minute) {  
        dateAndTime.set(Calendar.HOUR_OF_DAY, hourOfDay);  
        dateAndTime.set(Calendar.MINUTE, minute);  
        updateLabel();  
    }  
};  
}
```

The “model” for this activity is just a Calendar instance, initially set to be the current date and time. In the `updateLabel()` method, we take the current Calendar, format it using `DateUtils` and `formatDateTime()`, and put it in the `TextView`. The nice thing about using Android’s `DateUtils` class is that it will format dates and times using the user’s choice of date formatting, determined through the Settings application.

Each button has a corresponding method that will get control when the user clicks it (`chooseDate()` and `chooseTime()`). When the button is clicked, either a `DatePickerDialog` or a `TimePickerDialog` is shown. In the case of the `DatePickerDialog`, we give it an `OnDateSetListener` callback that updates the Calendar with the new date (year, month, day of month). We also give the dialog the last-selected date, getting the values out of the Calendar. In the case of the `TimePickerDialog`, it gets an `OnTimeSetListener` callback to update the time portion of the Calendar, the last-selected time, and a `true` indicating we want 24-hour mode on the time selector

With all this wired together, the resulting activity looks like this:

## DIALOGS AND DIALOGFRAGMENTS

---

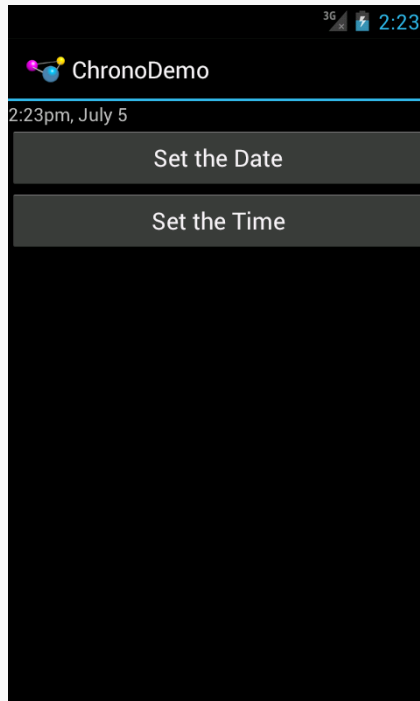


Figure 227: ChronoDemo, As Initially Launched, on Android 4.0.3

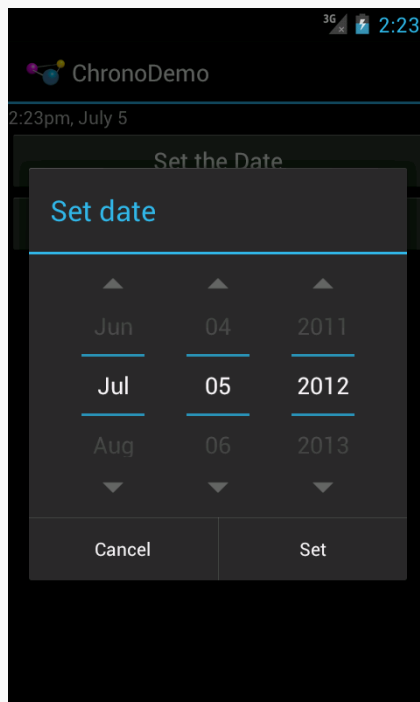
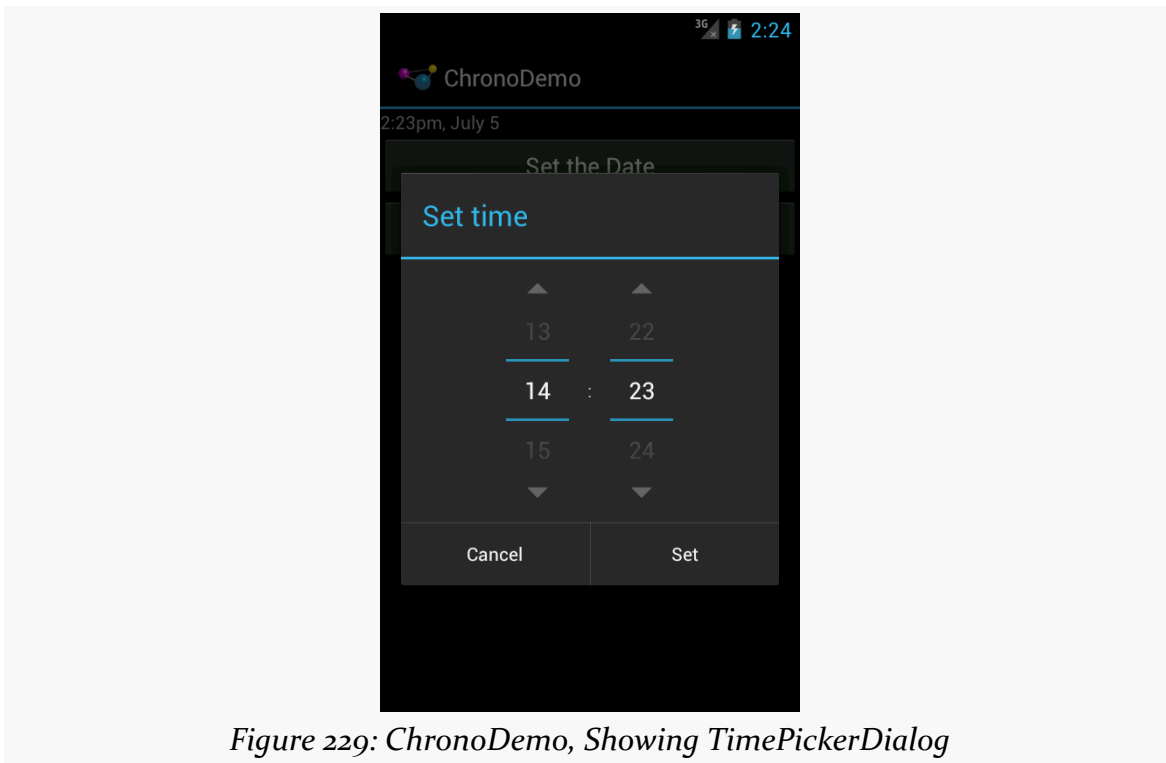


Figure 228: ChronoDemo, Showing DatePickerDialog





*Figure 229: ChronoDemo, Showing TimePickerDialog*

### Changes (and Bugs) in Jelly Bean

DatePickerDialog and TimePickerDialog were modified in Android 4.1, and not necessarily for the better.

First, the “Cancel” button has been removed, unless you specifically add a negative button listener to the underlying DatePicker or TimePicker widget:

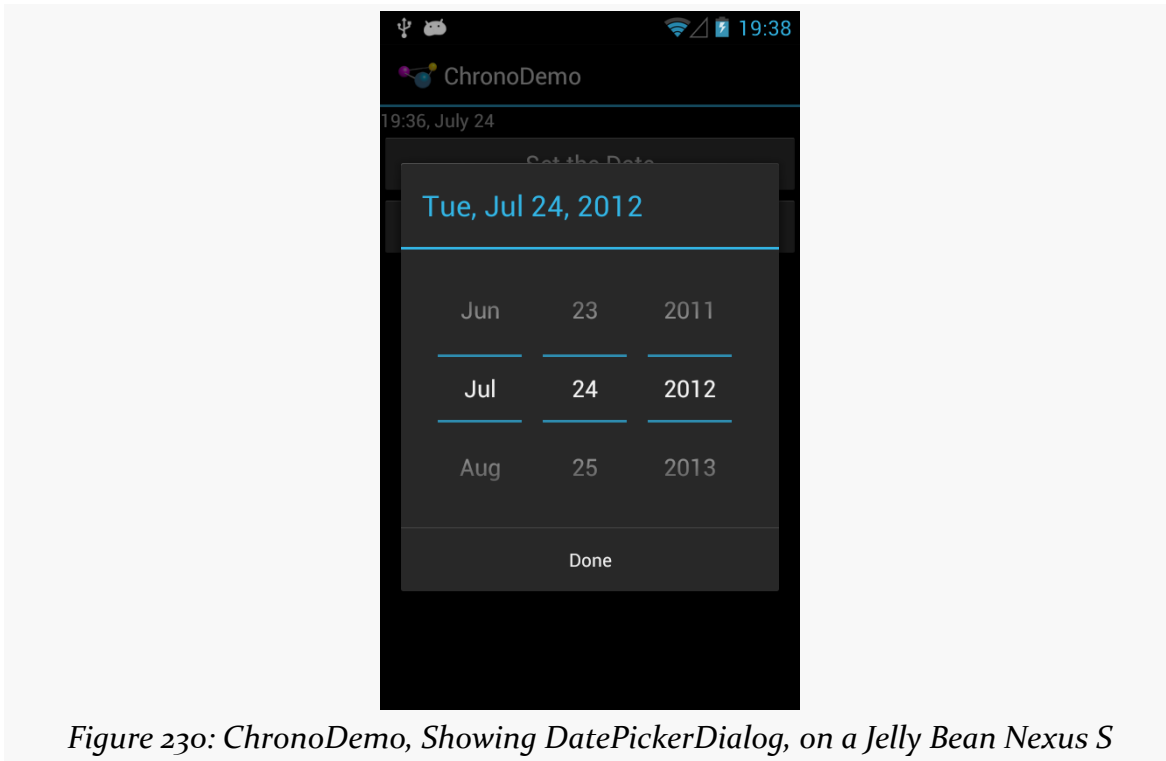


Figure 230: ChronoDemo, Showing DatePickerDialog, on a Jelly Bean Nexus S

The user can press BACK to exit the dialog, so all functionality is still there, but you may need to craft your documentation to accommodate this difference.

Then, your `OnDateSetListener` or `OnTimeSetListener` will be called an extra time. If the user presses BACK to leave the dialog, your `onDateSet()` or `onTimeSet()` will be called. If the user clicks the positive button of the dialog, you are called *twice*. There is a workaround [documented on StackOverflow](#), and [the bug report can be found on the Android issue tracker](#).

## AlertDialog

For your own custom dialogs, you could extend the `Dialog` base class, as do `DatePickerDialog` and `TimePickerDialog`. More commonly, though, developers create custom dialogs via `AlertDialog`, in large part due to the existence of `AlertDialog.Builder`. This builder class allows you to construct a custom dialog using a single (albeit long) Java statement, rather than having to create your own custom subclass. Builder offers a series of methods to configure an `AlertDialog`, each method returning the Builder for easy chaining.

Commonly-used configuration methods on Builder include:

- `setMessage()` if you want the “body” of the dialog to be a simple textual message, from either a supplied String or a supplied string resource ID.
- `setTitle()` and `setIcon()`, to configure the text and/or icon to appear in the title bar of the dialog box.
- `setPositiveButton()`, `setNegativeButton()`, and `setNeutralButton()`, to indicate which button(s) should appear across the bottom of the dialog, where they should be positioned (left, center, or right, respectively), what their captions should be, and what logic should be invoked when the button is clicked (besides dismissing the dialog).

Calling `create()` on the Builder will give you the `AlertDialog`, built according to your specifications. You can use additional methods on `AlertDialog` itself to perhaps configure things beyond what Builder happens to support.

Note, though, that calling `create()` does not actually display the dialog. The modern way to display the dialog is to tie it to a `DialogFragment`, as will be discussed in the next section.

## DialogFragments

One challenge with dialogs comes with configuration changes, notably screen rotations. If they pivot the device from portrait to landscape (or vice versa), presumably the dialog should remain on the screen after the change. However, since Android wants to destroy and recreate the activity, that would have dire impacts on your dialog.

Pre-fragments, Android had a “managed dialog” facility that would attempt to help with this. However, with the introduction of fragments came the `DialogFragment`, which handles the configuration change process.

You have two ways of supplying the dialog to the `DialogFragment`:

1. You can override `onCreateDialog()` and return a `Dialog`, such as `AlertDialog` created via an `AlertDialog.Builder`
2. You can override `onCreateView()`, as you would with an ordinary fragment, and the `View` that you return will be placed inside of a dialog

## DIALOGS AND DIALOGFRAGMENTS

---

The [Dialogs/DialogFragment](#) sample project demonstrates the use of a DialogFragment in conjunction with an AlertDialog in this fashion.

Here is our DialogFragment, named SampleDialogFragment:

```
package com.commonware.android.dlgfrag;

import android.app.AlertDialog;
import android.app.Dialog;
import android.content.DialogInterface;
import android.os.Bundle;
import android.support.v4.app.DialogFragment;
import android.util.Log;
import android.view.View;
import android.widget.EditText;
import android.widget.Toast;

public class SampleDialogFragment extends DialogFragment implements
    DialogInterface.OnClickListener {
    private View form=null;

    @Override
    public Dialog onCreateDialog(Bundle savedInstanceState) {
        form=
            getActivity().getLayoutInflater()
                .inflate(R.layout.dialog, null);

        AlertDialog.Builder builder=new AlertDialog.Builder(getActivity());

        return(builder.setTitle(R.string.dlg_title).setView(form)
            .setPositiveButton(android.R.string.ok, this)
            .setNegativeButton(android.R.string.cancel, null).create());
    }

    @Override
    public void onClick(DialogInterface dialog, int which) {
        String template=getActivity().getString(R.string.toast);
        EditText name=(EditText)form.findViewById(R.id.title);
        EditText value=(EditText)form.findViewById(R.id.value);
        String msg=
            String.format(template, name.getText().toString(),
                value.getText().toString());

        Toast.makeText(getActivity(), msg, Toast.LENGTH_LONG).show();
    }

    @Override
    public void onDismiss(DialogInterface unused) {
        super.onDismiss(unused);

        Log.d(getClass().getSimpleName(), "Goodbye!");
    }
}
```

```
@Override
public void onCancel(DialogInterface unused) {
    super.onCancel(unused);

    Toast.makeText(getActivity(), R.string.back, Toast.LENGTH_LONG).show();
}
}
```

In `onCreateDialog()`, we inflate a custom layout (`R.layout.dialog`) that consists of some `TextView` labels and `EditText` fields:

```
<?xml version="1.0" encoding="utf-8"?>
<LinearLayout xmlns:android="http://schemas.android.com/apk/res/android"
    android:layout_width="match_parent"
    android:layout_height="wrap_content"
    android:orientation="vertical">

    <LinearLayout
        android:layout_width="match_parent"
        android:layout_height="wrap_content"
        android:layout_margin="4dp"
        android:orientation="horizontal">

        <TextView
            android:layout_width="wrap_content"
            android:layout_height="wrap_content"
            android:text="@string/display_name"/>

        <EditText
            android:id="@+id/title"
            android:layout_width="match_parent"
            android:layout_height="wrap_content"
            android:inputType="text"/>
    </LinearLayout>

    <LinearLayout
        android:layout_width="match_parent"
        android:layout_height="wrap_content"
        android:layout_margin="4dp"
        android:orientation="horizontal">

        <TextView
            android:layout_width="wrap_content"
            android:layout_height="wrap_content"
            android:text="@string/value"/>

        <EditText
            android:id="@+id/value"
            android:layout_width="match_parent"
            android:layout_height="wrap_content"
            android:inputType="number"/>
    </LinearLayout>
</LinearLayout>
```

```
</LinearLayout>
```

We then create an instance of `AlertDialog.Builder`, then start configuring the dialog by calling a series of methods on the Builder:

- `setTitle()` to supply the text to appear in the title bar of the dialog
- `setView()` to define the contents of the dialog, in the form of our inflated View
- `setPositiveButton()` to define the caption of one button (set here to the Android-supplied “OK” string resource) and to arrange to get control when that button is clicked (via this as the second parameter and our activity implementing `DialogInterface.OnClickListener`)
- `setNegativeButton()` to define the caption of the other button (set here to the Android-supplied “Cancel” resource)

We do not supply a listener to `setNegativeButton()`, because we do not need one in this case. Whenever the user clicks on *any* of the buttons, the dialog will be dismissed automatically. Hence, you only need a listener if you intend to do something special beyond dismissing the dialog when a button is clicked.

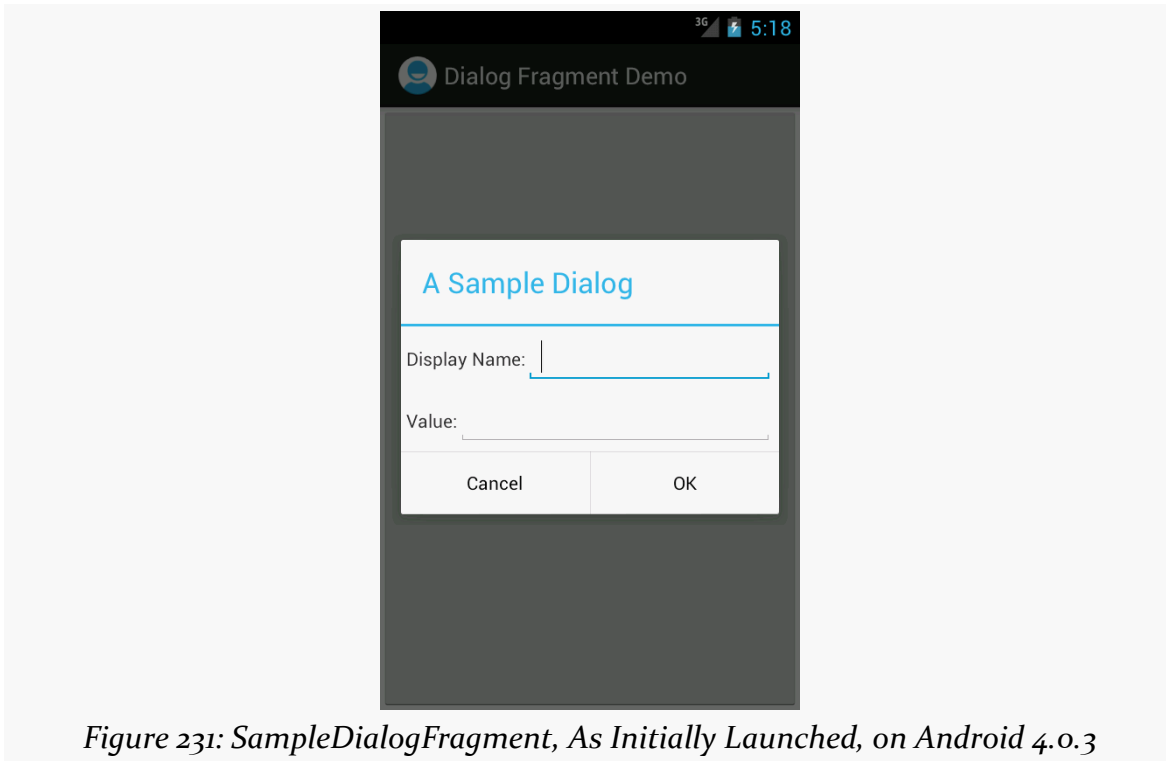
At that point, we call `create()` to construct the actual `AlertDialog` instance and hand that back to Android.

If the user taps our positive button, we are called with `onClick()` and can collect information from our form and do something with it, in this case displaying a Toast.

We also override:

- `onCancel()`, which is called if the user presses the BACK button to exit the dialog
- `onDismiss()`, which is called whenever the dialog goes away for any reason (BACK or a button click)

When you click the big button in the activity, our dialog is displayed:



*Figure 231: SampleDialogFragment, As Initially Launched, on Android 4.0.3*

Android will handle the configuration change, and so long as our dialog uses typical widgets like `EditText`, the standard configuration change logic will carry our data forward from the old activity's dialog to the new activity's dialog.

## Dialogs: Modal, Not Blocking

Dialogs in Android are modal in terms of UI. The user cannot proceed in your activity until they complete or dismiss the dialog.

Dialogs in Android are not blocking in terms of the programming model. When you call `show()` to display a dialog — either directly or by means of adding a `DialogFragment` to the screen — this is not a blocking call. The dialog will be displayed sometime after the call to `show()`, asynchronously. You use callbacks, such as the button event listeners, to find out about events going on with respect to the dialog that you care about.

This runs counter to a couple of GUI toolkits, where displaying the dialog blocks the thread that does the displaying. In those toolkits, the call to `show()` would not return until the dialog had been displayed and dealt with by the user. That being

## DIALOGS AND DIALOGFRAGMENTS

---

said, most modern GUI toolkits take the approach Android does and have dialogs be non-blocking. Some developers try to figure out some way of hacking a blocking approach on top of Android's non-blocking dialogs — their time would be far better spent learning modern event-driven programming.





# Advanced ListViews

---

The humble `Listview` is the backbone of many an Android application. On phone-sized screens, the screen may be dominated by a single `Listview`, to allow the user to choose something to examine in more detail (e.g., pick a contact). On larger screens, the `Listview` may be shown side-by-side with the details of the selected item, to minimize the “pogo stick” effect seen on phones as users bounce back and forth between the list and the details.

While we have covered the basics of `Listview` in the core chapters of this book, there is a lot more that you can do if you so choose, to make your lists that much more interesting — this chapter will cover some of these techniques.

## Prerequisites

Understanding this chapter requires that you have read the core chapters, particularly [the one on Adapter and AdapterView](#).

## Multiple Row Types, and Self Inflation

When we originally looked at `Listview`, we had all of our rows come from a common layout. Hence, while the data in each row would vary, the row structure itself would be consistent for all rows. This is very easy to set up, but it is not always what you want. Sometimes, you want a mix of row structures, such as header rows versus detail rows, or detail rows that vary a bit in structure based on the data:

## ADVANCED LISTVIEWS

---

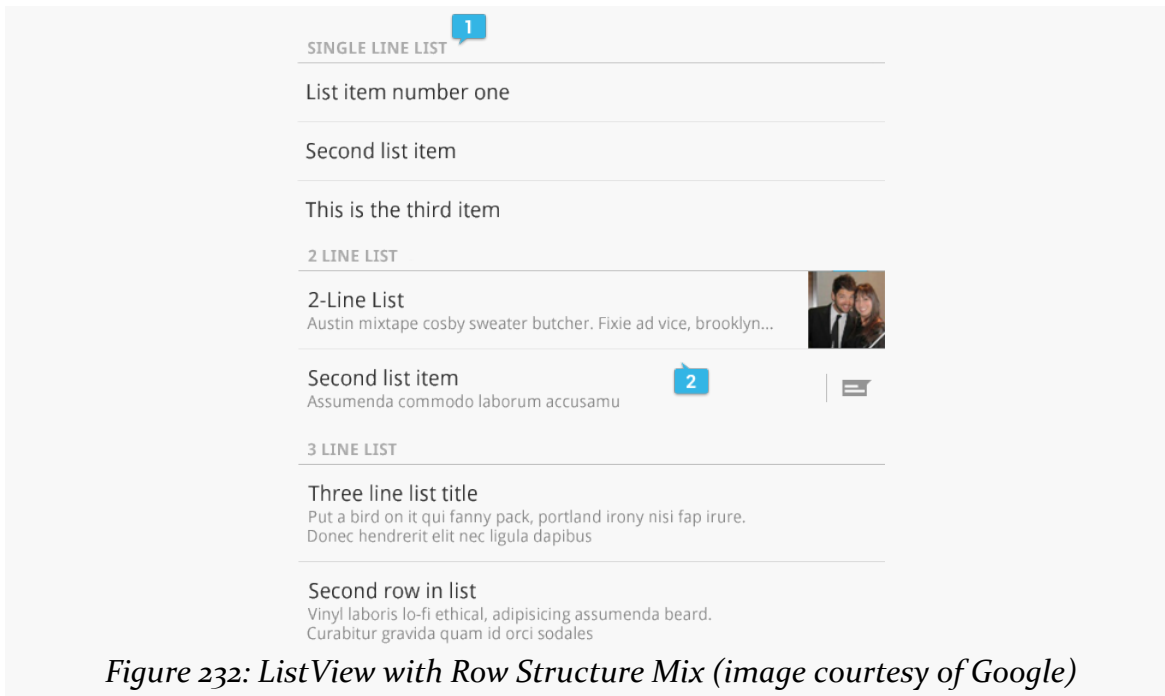


Figure 232: ListView with Row Structure Mix (image courtesy of Google)

Here, we see some header rows (e.g., “SINGLE LINE LIST”) along with detail rows. While the detail rows visually vary a bit, they might still be all inflated from the same layout, simply making some pieces (second line of text, thumbnail, etc.) visible or invisible as needed. However, the header rows are sufficiently visually distinct that they really ought to come from separate layouts.

The good news is that Android supports multiple row types. However, this comes at a cost: you will need to handle the row creation yourself, rather than chaining to the superclass.

Our sample project, [Selection/HeaderDetailList](#) will demonstrate this, along with showing how you can create your own custom adapter straight from BaseAdapter, for data models that do not quite line up with what Android supports natively.

### Our Data Model and Planned UI

The HeaderDetailList project is based on the ViewHolderDemo project from [the chapter on ListView](#). However, this time, we have our list of 25 nonsense words broken down into five groups of five, as seen in the HeaderDetailList activity:

```
private static final String[][] items= {  
    { "lorem", "ipsum", "dolor", "sit", "amet" },
```

## ADVANCED LISTVIEWS

---

```
{ "consectetuer", "adipiscing", "elit", "morbi", "vel" },  
{ "ligula", "vitae", "arcu", "aliquet", "mollis" },  
{ "etiam", "vel", "erat", "placerat", "ante" },  
{ "porttitor", "sodales", "pellentesque", "augue", "purus" } };
```

We want to display a header row for each batch:

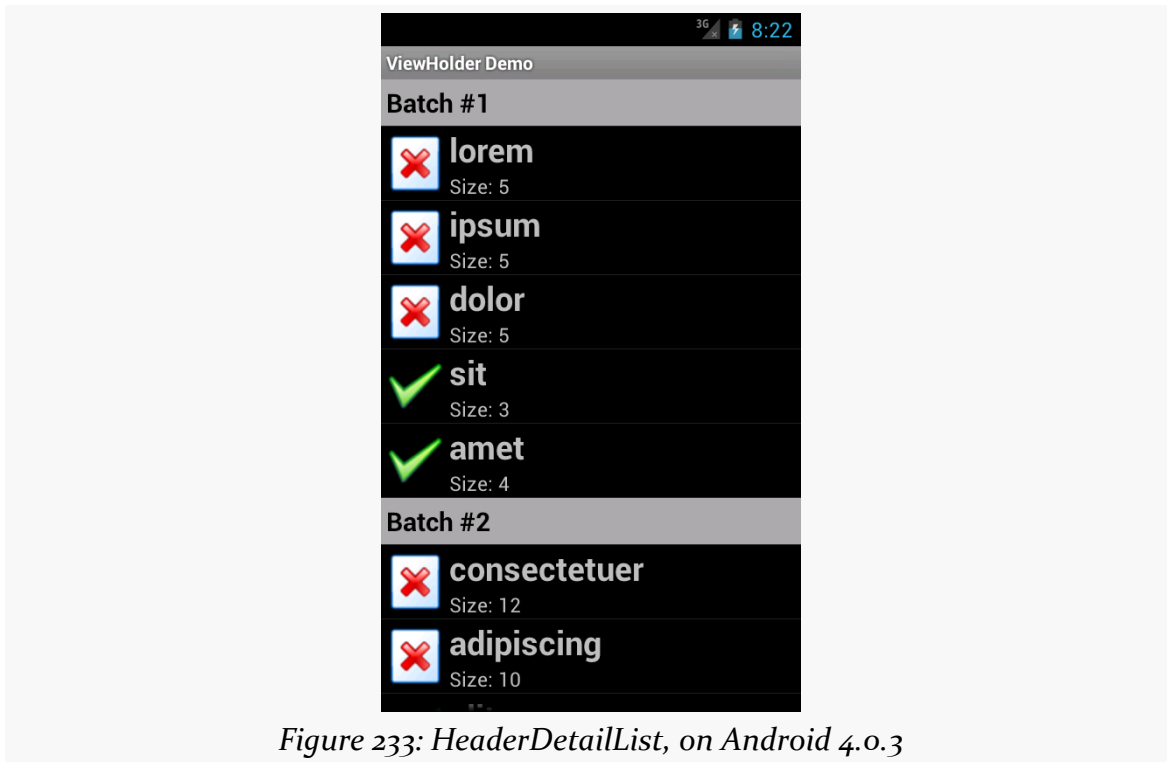


Figure 233: HeaderDetailList, on Android 4.0.3

### The Basic BaseAdapter

Once again, we have a custom ListAdapter named IconicAdapter. However, this time, instead of inheriting from ArrayAdapter, or even CursorAdapter, we are inheriting from BaseAdapter. As the name suggests, BaseAdapter is a basic implementation of the ListAdapter interface, with stock implementations of many of the ListAdapter methods. However, BaseAdapter is abstract, and so there are a few methods that we need to implement:

- `getCount()` returns the total number of rows that would be in the list. In our case, we total up the sizes of each of the batches, plus add one for each batch for our header rows:

## ADVANCED LISTVIEWS

---

```
@Override
public int getCount() {
    int count=0;

    for (String[] batch : items) {
        count+=1 + batch.length;
    }

    return(count);
}
```

- `getItem()` needs to return the data model for a given position, passed in as the typical `int` index. An `ArrayAdapter` would return the value out of the array at that index; a `CursorAdapter` would return the `Cursor` positioned at that row. In our case, we will return one of two objects: either the `String` for rows that are to display a nonsense word, or an `Integer` containing our batch's index for rows that are to be a header:

```
@Override
public Object getItem(int position) {
    int offset=position;
    int batchIndex=0;

    for (String[] batch : items) {
        if (offset == 0) {
            return(Integer.valueOf(batchIndex));
        }

        offset--;

        if (offset < batch.length) {
            return(batch[offset]);
        }

        offset-=batch.length;
        batchIndex++;
    }

    throw new IllegalArgumentException("Invalid position: "
        + String.valueOf(position));
}
```

- `getItemId()` needs to return a unique `long` value for a given position. A `CursorAdapter` would find the `_id` value in the `Cursor` for that position and return it. In our case, lacking anything else, we simply return the position itself:

```
@Override
public long getItemId(int position) {
    return(position);
}
```

- `getView()`, which returns the `View` to use for a given row. This is the method that we overrode on our `IconicAdapter` in some previous incarnations to tailor the way the rows were populated. Our `getView()` implementation will be a bit more complex in this case, due to our multiple-row-type requirement, so we will examine it a bit later in this section.

### Requesting Multiple Row Types

The methods listed above are the abstract ones that you have no choice but to implement yourself. Anything else on the `ListAdapter` interface that you wish to override you can, to replace the stub implementation supplied by `BaseAdapter`.

If you wish to have more than one type of row, there are two such methods that you will wish to override:

- `getViewTypeCount()` needs to return the number of distinct row types you will use. In our case, there are just two:

```
@Override
public int getViewTypeCount() {
    return(2);
}
```

- `getItemViewType()` needs to return a value from 0 to `getViewTypeCount()-1`, indicating the index of the particular row type to use for a particular row position. In our case, we need to return different values for headers (0) and detail rows (1). To determine which is which, we use `getItem()` — if we get an `Integer` back, we need to use a header row for that position:

```
@Override
public int getItemViewType(int position) {
    if (getItem(position) instanceof Integer) {
        return(0);
    }

    return(1);
}
```

The reason for supplying this information is for row recycling. The `View` that is passed into `getView()` is either `null` or a row that we had previously created that has scrolled off the screen. By passing us this now-unused `View`, Android is asking us to reuse it if possible. By specifying the row type for each position, Android will ensure

that it hands us the right type of row for recycling — we will not be passed in a header row to recycle when we need to be returning a detail row, for example.

### Creating and Recycling the Rows

Our `getView()` implementation, then, needs to have two key enhancements over previous versions:

1. We need to create the rows ourselves, particularly using the appropriate layout for the required row type (header or detail)
2. We need to recycle the rows when they are provided, as this has a **major** impact on the scrolling speed of our `ListView`

To help simplify the logic, we will have `getView()` focus on the detail rows, with a separate `getHeaderView()` to create/recycle and populate the header rows. Our `getView()` determines up front whether the row required is a header and, if so, delegates the work to `getHeaderView()`:

```
@Override
public View getView(int position, View convertView, ViewGroup parent) {
    if (getItemViewType(position) == 0) {
        return(getHeaderView(position, convertView, parent));
    }

    View row=convertView;

    if (row == null) {
        row=getLayoutInflater().inflate(R.layout.row, parent, false);
    }

    ViewHolder holder=(ViewHolder)row.getTag();

    if (holder == null) {
        holder=new ViewHolder(row);
        row.setTag(holder);
    }

    String word=(String)getItem(position);

    if (word.length() > 4) {
        holder.icon.setImageResource(R.drawable.delete);
    }
    else {
        holder.icon.setImageResource(R.drawable.ok);
    }

    holder.label.setText(word);
    holder.size.setText(String.format(getString(R.string.size_template),
```

```
        word.length());  
  
    return(row);  
}
```

Assuming that we are to create a detail row, we then check to see if we were passed in a non-null View. If we were passed in null, we cannot recycle that row, so we have to inflate a new one via a call to `inflate()` on a `LayoutInflater` we get via `getLayoutInflater()`. But, if we were passed in an actual View to recycle, we can skip this step.

From here, the `getView()` implementation is largely the way it was before, including dealing with the `ViewHolder`. The only change of significance is that we have to manage the label `TextView` ourselves — before, we chained to the superclass and let `ArrayAdapter` handle that. So our `ViewHolder` now has a label data member with our label `TextView`, and we fill it in along with the size and icon. Also, we use `getItem()` to retrieve our nonsense word, so it can find the right word for the given position out of our various word batches.

Our `getHeaderView()` does much the same thing, except it uses `getItem()` to retrieve our batch index, and we use that for constructing our header:

```
private View getHeaderView(int position, View convertView,  
                           ViewGroup parent) {  
    View row=convertView;  
  
    if (row == null) {  
        row=getLayoutInflater().inflate(R.layout.header, parent, false);  
    }  
  
    Integer batchIndex=(Integer)getItem(position);  
    TextView label=(TextView)row.findViewById(R.id.label);  
  
    label.setText(String.format(getString(R.string.batch),  
                               1 + batchIndex.intValue()));  
  
    return(row);  
}
```

## Choice Modes and the Activated Style

In [the chapter on large-screen strategies](#), we saw the EU4You sample application, and we mentioned that the `ListView` formatted its rows as “activated” to represent the current selection, when the `ListView` was side-by-side with the details.



In [the chapter on styles](#), we saw an example of an “activated” style that referred to a device-specific color to use for an activated background. It just so happens that this is the same style that we used in EU4You.

Hence, the recipe for using activated notation for a `ListView` adjacent to details on the last-clicked-upon `ListView` row is:

- Use `CHOICE_MODE_SINGLE` (or `android:choiceMode="singleChoice"`) on the `ListView`.
- Have a style resource, in `res/values-v11/`, that references the device-specific activated background:

```
<?xml version="1.0" encoding="utf-8"?>
<resources>
  <style name="activated" parent="android:Theme.Holo">
    <item name="android:background">?android:attr/
activatedBackgroundIndicator</item>
  </style>
</resources>
```

- Have the same style resource also defined in `res/values` if you are supporting pre-Honeycomb devices, where you skip the parent and the background color override, as neither of those specific values existed before API Level 11:

```
<?xml version="1.0" encoding="utf-8"?>
<resources>
  <style name="activated">
  </style>
</resources>
```

- Use that style as the background of your `ListView` row (e.g., `style="@style/activated"`)

Android will automatically color the row background based upon the last row clicked, instead of checking a `RadioButton` as you might ordinarily see with `CHOICE_MODE_SINGLE` lists.

## Custom Mutable Row Contents

Lists with pretty icons next to them are all fine and well. But, can we create `ListView` widgets whose rows contain interactive child widgets instead of just passive widgets like `TextView` and `ImageView`? For example, there is a `RatingBar` widget that allows users to assign a rating by clicking on a set of star icons. Could we combine the

## ADVANCED LISTVIEWS

---

RatingBar with text in order to allow people to scroll a list of, say, songs and rate them right inside the list?

There is good news and bad news.

The good news is that interactive widgets in rows work just fine. The bad news is that it is a little tricky, specifically when it comes to taking action when the interactive widget's state changes (e.g., a value is typed into a field). We need to store that state somewhere, since our RatingBar widget will be recycled when the ListView is scrolled. We need to be able to set the RatingBar state based upon the actual word we are viewing as the RatingBar is recycled, and we need to save the state when it changes so it can be restored when this particular row is scrolled back into view.

What makes this interesting is that, by default, the RatingBar has absolutely no idea what item in the ArrayAdapter it represents. After all, the RatingBar is just a widget, used in a row of a ListView. We need to teach the rows which item in the ArrayAdapter they are currently displaying, so when their RatingBar is checked, they know which item's state to modify.

So, let's see how this is done, using the activity in the [Selection/RateList](#) sample project. We will use the same basic classes as in most of our ListView samples, where we are showing a list of nonsense words. In this case, you can rate the words on a three-star rating. Words given a top rating are put in all caps:

```
package com.commonware.android.ratelist;

import android.app.ListActivity;
import android.os.Bundle;
import android.view.View;
import android.view.ViewGroup;
import android.widget.ArrayAdapter;
import android.widget.LinearLayout;
import android.widget.RatingBar;
import android.widget.TextView;
import java.util.ArrayList;

public class RateListDemo extends ListActivity {
    private static final String[] items={"lorem", "ipsum", "dolor",
        "sit", "amet",
        "consectetuer", "adipiscing", "elit", "morbi", "vel",
        "ligula", "vitae", "arcu", "aliquet", "mollis",
        "etiam", "vel", "erat", "placerat", "ante",
        "porttitor", "sodales", "pellentesque", "augue", "purus"};

    @Override
```

## ADVANCED LISTVIEWS

---

```
public void onCreate(Bundle icle) {
    super.onCreate(icle);

    ArrayList<RowModel> list=new ArrayList<RowModel>();

    for (String s : items) {
        list.add(new RowModel(s));
    }

    setListAdapter(new RatingAdapter(list));
}

private RowModel getModel(int position) {
    return(((RatingAdapter)getListAdapter()).getItem(position));
}

class RatingAdapter extends ArrayAdapter<RowModel> {
    RatingAdapter(ArrayList<RowModel> list) {
        super(RateListDemo.this, R.layout.row, R.id.label, list);
    }

    public View getView(int position, View convertView,
        ViewGroup parent) {
        View row=super.getView(position, convertView, parent);
        RatingBar bar=(RatingBar)row.getTag();

        if (bar==null) {
            bar=(RatingBar)row.findViewById(R.id.rate);
            row.setTag(bar);

            RatingBar.OnRatingBarChangeListener l=
                new RatingBar.OnRatingBarChangeListener() {
                    public void onRatingChanged(RatingBar ratingBar,
                        float rating,
                        boolean fromTouch) {
                        Integer myPosition=(Integer)ratingBar.getTag();
                        RowModel model=getModel(myPosition);

                        model.rating=rating;

                        LinearLayout parent=(LinearLayout)ratingBar.getParent();
                        TextView label=(TextView)parent.findViewById(R.id.label);

                        label.setText(model.toString());
                    }
                };

            bar.setOnRatingBarChangeListener(l);
        }

        RowModel model=getModel(position);

        bar.setTag(Integer.valueOf(position));
        bar.setRating(model.rating);
    }
}
```

```
        return(row);
    }
}

class RowModel {
    String label;
    float rating=2.0f;

    RowModel(String label) {
        this.label=label;
    }

    public String toString() {
        if (rating>=3.0) {
            return(label.toUpperCase());
        }

        return(label);
    }
}
```

Here is what is different in this activity and `getView()` implementation than in earlier, simpler samples:

1. While we are still using `String` array items as the list of nonsense words, rather than pour that `String` array straight into an `ArrayAdapter`, we turn it into a list of `RowModel` objects. `RowModel` is the mutable model: it holds the nonsense word plus the current rating. In a real system, these might be objects populated from a database, and the properties would have more business meaning.
2. Utility methods like `onListItemClick()` had to be updated to reflect the change from a pure-`String` model to use a `RowModel`.
3. The `ArrayAdapter` subclass (`RatingAdapter`), in `getView()`, lets `ArrayAdapter` inflate and recycle the row, then checks to see if we have a `ViewHolder` in the row's tag. If not, we create a new `ViewHolder` and associate it with the row. For the row's `RatingBar`, we add an anonymous `onRatingChanged()` listener that looks at the row's tag (`getTag()`) and converts that into an `Integer`, representing the position within the `ArrayAdapter` that this row is displaying. Using that, the rating bar can get the actual `RowModel` for the row and update the model based upon the new state of the rating bar. It also updates the text adjacent to the `RatingBar` when checked to match the rating bar state.

## ADVANCED LISTVIEWS

---

4. We always make sure that the RatingBar has the proper contents and has a tag (via setTag()) pointing to the position in the adapter the row is displaying.

The row layout is very simple: just a RatingBar and a TextView inside a LinearLayout:

```
<?xml version="1.0" encoding="utf-8"?>
<LinearLayout xmlns:android="http://schemas.android.com/apk/res/android"
    android:layout_width="fill_parent"
    android:layout_height="wrap_content"
    android:orientation="horizontal"
    >
    <RatingBar
        android:id="@+id/rate"
        android:layout_width="wrap_content"
        android:layout_height="wrap_content"
        android:numStars="3"
        android:stepSize="1"
        android:rating="2" />
    <TextView
        android:id="@+id/label"
        android:padding="2dip"
        android:textSize="18sp"
        android:layout_gravity="left|center_vertical"
        android:layout_width="fill_parent"
        android:layout_height="wrap_content"/>
</LinearLayout>
```

And the result is what you would expect, visually:

## ADVANCED LISTVIEWS

---

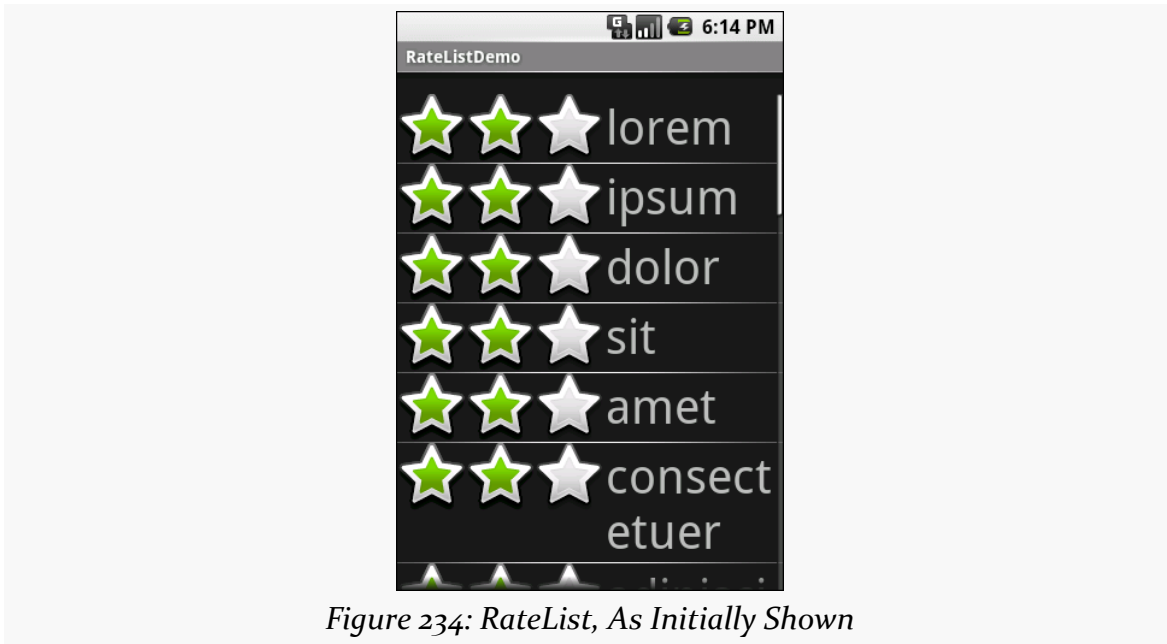


Figure 234: RateList, As Initially Shown

This includes the toggled rating bars turning their words into all caps:

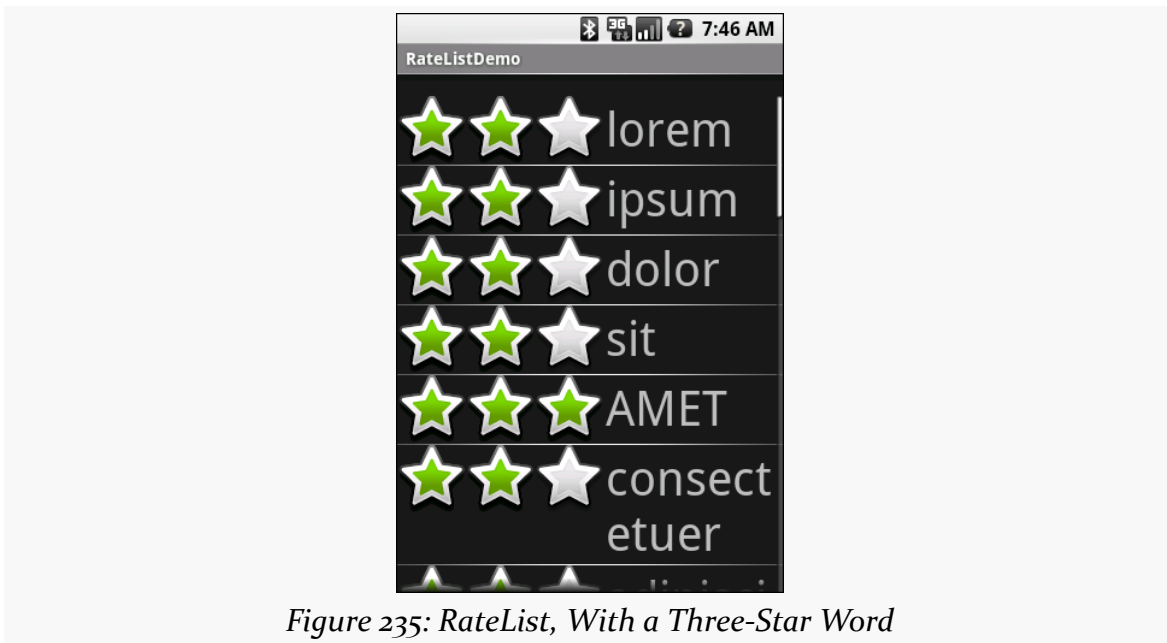


Figure 235: RateList, With a Three-Star Word

## From Head To Toe

Perhaps you do not need section headers scattered throughout your list. If you only need extra “fake rows” at the beginning or end of your list, you can use header and footer views.

ListView supports `addHeaderView()` and `addFooterView()` methods that allow you to add View objects to the beginning and end of the list, respectively. These View objects otherwise behave like regular rows, in that they are part of the scrolled area and will scroll off the screen if the list is long enough. If you want fixed headers or footers, rather than put them in the ListView itself, put them outside the ListView, perhaps using a `LinearLayout`.

To demonstrate header and footer views, take a peek at the [Selection/HeaderFooter](#) sample project, particularly the `HeaderFooterDemo` class:

```
package com.commonware.android.header;

import java.util.Arrays;
import java.util.Collections;
import java.util.List;
import android.app.ListActivity;
import android.os.Bundle;
import android.os.SystemClock;
import android.view.View;
import android.widget.AdapterView;
import android.widget.Button;
import android.widget.TextView;

public class HeaderFooterDemo extends ListActivity {
    private static String[] items={"lorem", "ipsum", "dolor",
        "sit", "amet", "consectetuer",
        "adipiscing", "elit", "morbi",
        "vel", "ligula", "vitae",
        "arcu", "aliquet", "mollis",
        "etiam", "vel", "erat",
        "placerat", "ante",
        "porttitor", "sodales",
        "pellentesque", "augue",
        "purus"};

    private long startTime=SystemClock.uptimeMillis();
    private boolean areWeDeadYet=false;

    @Override
    public void onCreate(Bundle icle) {
        super.onCreate(icle);
        setContentView(R.layout.main);
        getListView().addHeaderView(buildHeader());
    }
}
```

## ADVANCED LISTVIEWS

---

```
        getListView().addFooterView(buildFooter());
        setListAdapter(new ArrayAdapter<String>(this,
            android.R.layout.simple_list_item_1,
            items));
    }

    @Override
    public void onDestroy() {
        super.onDestroy();

        areWeDeadYet=true;
    }

    private View buildHeader() {
        Button btn=new Button(this);

        btn.setText("Randomize!");
        btn.setOnClickListener(new View.OnClickListener() {
            public void onClick(View v) {
                List<String> list=Arrays.asList(items);

                Collections.shuffle(list);

                setListAdapter(new ArrayAdapter<String>(HeaderFooterDemo.this,
                    android.R.layout.simple_list_item_1,
                    list));
            }
        });

        return(btn);
    }

    private View buildFooter() {
        TextView txt=new TextView(this);

        updateFooter(txt);

        return(txt);
    }

    private void updateFooter(final TextView txt) {
        long runtime=(SystemClock.uptimeMillis()-startTime)/1000;

        txt.setText(String.valueOf(runtime)+" seconds since activity launched");

        if (!areWeDeadYet) {
            getListView().postDelayed(new Runnable() {
                public void run() {
                    updateFooter(txt);
                }
            }, 1000);
        }
    }
}
```

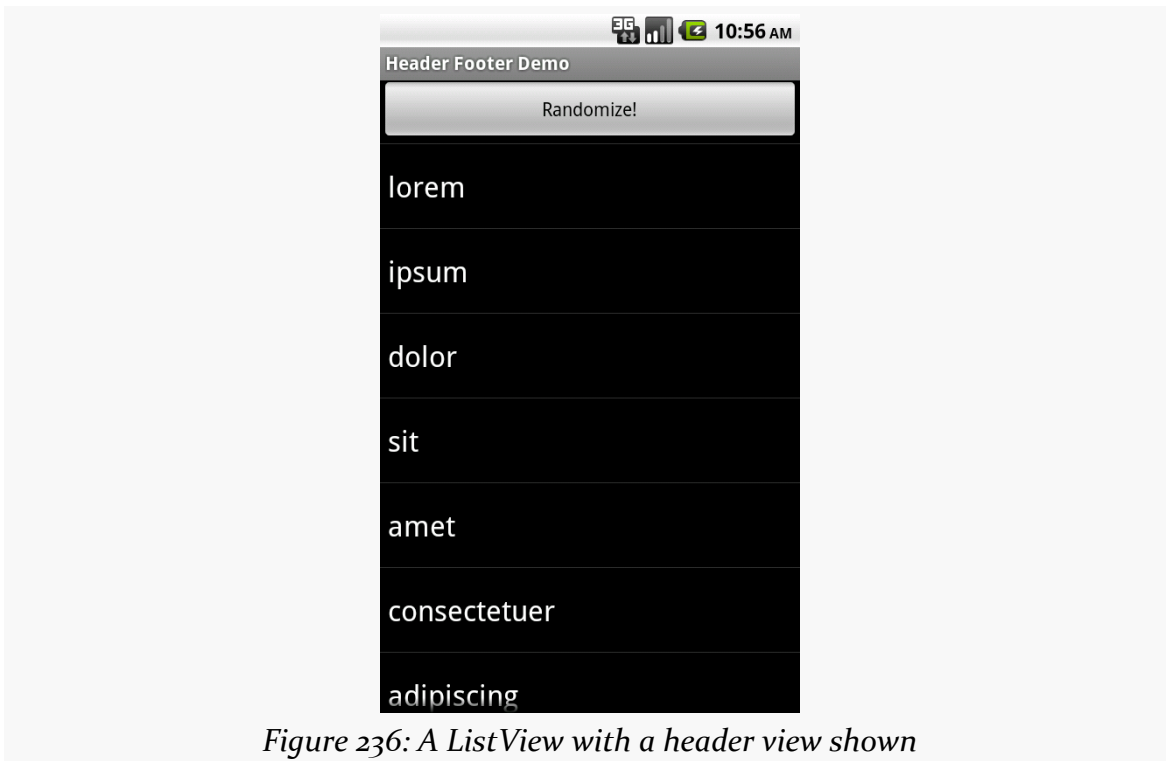


## ADVANCED LISTVIEWS

---

Here, we add a header View built via `buildHeader()`, returning a Button that, when clicked, will shuffle the contents of the list. We also add a footer View built via `buildFooter()`, returning a TextView that shows how long the activity has been running, updated every second. The list itself is the ever-popular list of *lorem ipsum* words.

When initially displayed, the header is visible but the footer is not, because the list is too long:

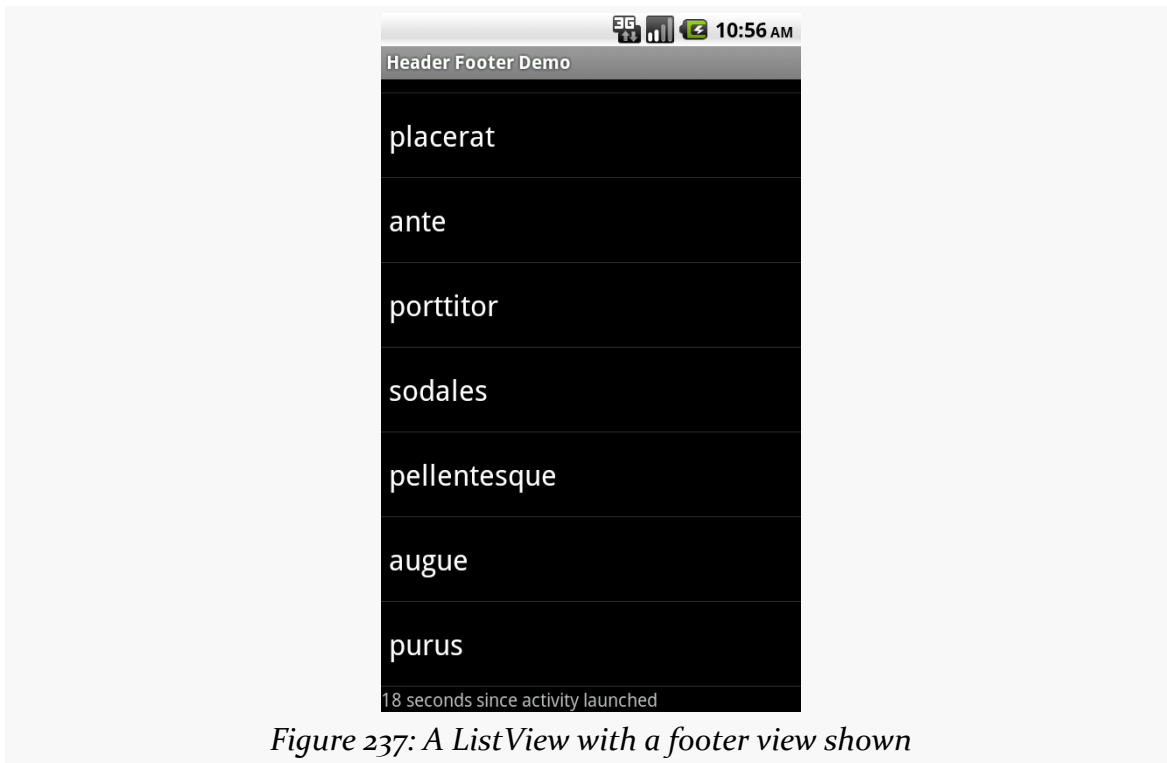


*Figure 236: A ListView with a header view shown*

If you scroll downward, the header will slide off the top, and eventually the footer will scroll into view:

## ADVANCED LISTVIEWS

---



*Figure 237: A List View with a footer view shown*



# Action Bar Navigation

---

Beyond the home affordance (a.k.a., icon on the left), action bar toolbar items, and the overflow menu, the action bar also supports a navigation area. This resides to the right of the home affordance and to the left of the toolbar items/overflow menu. You can:

- Put tabs in here, to allow users to switch between portions of your app
- Use “list navigation”, which effectively puts a Spinner in here, also to allow users to switch from place to place
- Put in some other custom form of navigation, such as a search field

This chapter will review how to do these things, and how they tie into other constructs in Android, notably the `ViewPager`.

## Prerequisites

Understanding this chapter requires that you have read the core chapters, particularly [the one on the action bar](#).

## List Navigation

Android’s action bar supports a “list navigation” option. Despite the name, the “list” is really a Spinner, hosted in the action bar. You get to populate the Spinner via your own `SpinnerAdapter`, and you get control when the user changes the selected item, so that you can update your UI as you see fit.

To set this up:

## ACTION BAR NAVIGATION

---

1. Call `setNavigationMode(ActionBar.NAVIGATION_MODE_LIST)` on the `ActionBar` to enable the list navigation mode, which you get via `getActionBar()` (or `getSupportActionBar()` for `ActionBarSherlock` apps)
2. Call `setListNavigationCallbacks()` on the `ActionBar`, simultaneously supplying the `SpinnerAdapter` to use to populate the `Spinner` and an `ActionBar.OnNavigationListener` object to be notified when there is a selection change in the `Spinner`

The [ActionBar/ListNav](#) sample project demonstrates this, using a variation on the “whole lot of editors” UI first seen in [the ViewPager chapter](#).

We want to display a full-screen `EditText` widget whose contents will be driven by the list navigation selection. The fragment for this — `EditorFragment` — is a slightly revised version of the same class from the `ViewPager` samples. Here, though, state management will be handled completely by the activity, so we simply expose getters and setters as needed for working with the text in the editor, along with its hint:

```
package com.commonware.android.listnav;

import android.os.Bundle;
import android.view.LayoutInflater;
import android.view.View;
import android.view.ViewGroup;
import android.widget.EditText;
import com.actionbarsherlock.app.SherlockFragment;

public class EditorFragment extends SherlockFragment {
    private EditText editor=null;

    @Override
    public View onCreateView(LayoutInflater inflater,
                            ViewGroup container,
                            Bundle savedInstanceState) {
        View result=inflater.inflate(R.layout.editor, container, false);

        editor=(EditText)result.findViewById(R.id.editor);

        return(result);
    }

    CharSequence getText() {
        return(editor.getText());
    }

    void setText(CharSequence text) {
        editor.setText(text);
    }

    void setHint(CharSequence hint) {
```

## ACTION BAR NAVIGATION

---

```
        editor.setHint(hint);
    }
}
```

Setting up the list navigation mode is part of the work we do in `onCreate()`:

```
    ArrayAdapter<String> nav=null;
    ActionBar bar=getSupportActionBar();

    if (Build.VERSION.SDK_INT >= Build.VERSION_CODES.ICE_CREAM_SANDWICH) {
        nav=
            new ArrayAdapter<String>(
                bar.getThemedContext(),
                android.R.layout.simple_spinner_item,
                labels);
    }
    else {
        nav=
            new ArrayAdapter<String>(
                this,
                android.R.layout.simple_spinner_item,
                labels);
    }

    nav.setDropDownViewResource(android.R.layout.simple_spinner_dropdown_item);
    bar.setNavigationMode(ActionBar.NAVIGATION_MODE_LIST);
    bar.setListNavigationCallbacks(nav, this);
```

Android 4.0 (Ice Cream Sandwich) offers a `getThemedContext()` method on `ActionBar`. Use the `Context` returned by this method when working with resources that relate to the `ActionBar`. In this case, we use it when creating our `ArrayAdapter` to use with the `Spinner`. However, since this is only available on API Level 14 and higher, you need to check for that and fall back to using the `Activity` as your `Context` for earlier versions of Android.

We then use `setNavigationMode()` to indicate that we want list navigation, then use `setListNavigationCallbacks()` to supply our `ArrayAdapter`, plus our implementation of `OnNavigationItemSelectedListener` — in this case, we are implementing this interface on the activity itself.

Because we are implementing `OnNavigationItemSelectedListener`, we need to override the `onNavigationItemSelected()` method. This will get called when the `Spinner` selection changes (including when it is initially set), and it is up to us to affect our UI. That requires a bit of additional preparation work:

- We set up our `EditorFragment` in `onCreate()`, if it does not already exist:

## ACTION BAR NAVIGATION

---

```
frag=  
(EditorFragment)getSupportFragmentManager().findFragmentById(android.R.id.content);  
  
if (frag==null) {  
    frag=new EditorFragment();  
    getSupportFragmentManager().beginTransaction()  
        .add(android.R.id.content, frag)  
        .commit();  
}
```

- We track the last known position of the Spinner selection, by means of a `lastPosition` data member
- We store our data model (the text held by the editor) in a `models` `CharSequence` array

Our objective is to have 10 total “editors”, accessible via the list navigation. Our `labels` array in our `ArrayAdapter` has 10 entries, and `models` is a 10-item array to match.

That allows us to implement `onNavigationItemSelected()`:

```
@Override  
public boolean onNavigationItemSelected(int itemPosition, long itemId) {  
    if (lastPosition > -1) {  
        models[lastPosition]=frag.getText();  
    }  
  
    lastPosition=itemPosition;  
    frag.setText(models[itemPosition]);  
    frag.setHint(labels[itemPosition]);  
  
    return(true);  
}
```

In the `ViewPager` sample, we actually had 10 instances of `EditorFragment`. Here, we have just one, that we are going to use for all 10 positions. Hence, all we do is grab the current contents of the editor and save them in `models` (except when we are first starting and have no prior position). Then, we populate the editor with the next model and a suitable hint.

Now, we *could* have 10 instances of `EditorFragment` and swap between them with `FragmentTransactions`. Or, we could have a variety of distinct fragment instances, from different classes, and swap between them using `FragmentTransactions`. What you do to update your UI based upon the list navigation change is up to you.

## ACTION BAR NAVIGATION

---

One limitation of list navigation, compared to `ViewPager`, is state management on configuration changes. `ViewPager` handled keeping track of what page we were on, and if we retained all our fragments, our model data (the editors' contents) were retained as well. With list navigation and a single non-retained fragment, we have to do all of that ourselves.

So, we implement `onSaveInstanceState()` to persist both the `models` array and our current position:

```
@Override
public void onSaveInstanceState(Bundle state) {
    if (lastPosition > -1) {
        models[lastPosition]=frag.getText();
    }

    state.putCharSequenceArray(KEY_MODELS, models);
    state.putInt(KEY_POSITION,
        getSupportActionBar().getSelectedNavigationIndex());
}
```

In `onCreate()`, we restore our `models` array:

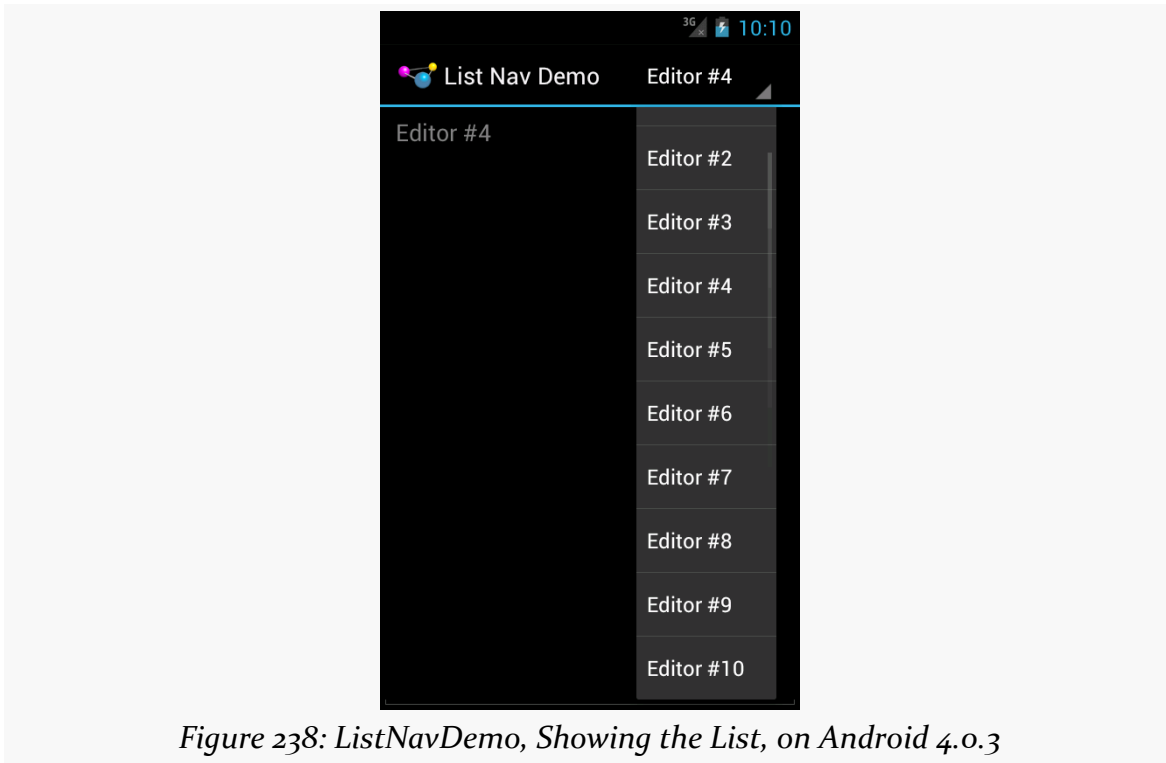
```
if (state != null) {
    models=state.getCharSequenceArray(KEY_MODELS);
}
```

And, later in `onCreate()`, we tell the action bar which position to select:

```
if (state != null) {
    bar.setSelectedNavigationItem(state.getInt(KEY_POSITION));
}
```

The result is a Spinner in the action bar, allowing the user to choose which of the 10 “editors” to work with:





*Figure 238: ListNavDemo, Showing the List, on Android 4.0.3*

## Tabs (And Sometimes List) Navigation

Similarly, you can set up tab navigation, where you present a roster of tabs the user can tap on.

Maybe.

(We'll get to the explanation of "maybe" in a bit)

Setting up tabs is fairly straightforward, once you know the recipe:

1. Call `setNavigationMode(ActionBar.NAVIGATION_MODE_TABS)` on the `ActionBar`, which you get via `getActionBar()` (or `getSupportActionBar()` for `ActionBarSherlock` apps)
2. Call `addTab()` on `ActionBar` for each tab you want, supplying at minimum the text caption of the tab and a `TabListener` implementation that will be notified of state changes in that tab

## ACTION BAR NAVIGATION

---

The [ActionBar/TabFragmentDemo](#) sample project is very similar to the one for list navigation described above, except that it uses tabs instead of list navigation. We have the same 10 editors, the same data model (`models`), and the same basic logic for saving and restoring our instance state. What differs is in how we set up the UI.

As with list navigation, you can do whatever you want when tabs are selected or unselected. You could:

- Add and remove fragments
- Attach and detach fragments (which remove them from the UI but keep them in the `FragmentManager` for later reuse)
- Flip pages of a `ViewPager`
- Update a simple UI in place (akin to what we did in the list navigation sample above)

In our case, we will take the “caveman” approach of replacing our entire fragment on each tab click.

Our `EditorFragment` is a bit closer to the original from the `ViewPager` samples, except that this time we pass in the initial text to display, along with the position, in the factory method:

```
package com.commonsware.android.tabfrag;

import android.os.Bundle;
import android.view.LayoutInflater;
import android.view.View;
import android.view.ViewGroup;
import android.widget.EditText;
import com.actionbarsherlock.app.SherlockFragment;

public class EditorFragment extends SherlockFragment {
    private static final String KEY_POSITION="position";
    private static final String KEY_TEXT="text";
    private EditText editor=null;

    static EditorFragment newInstance(int position,
                                     CharSequence text) {
        EditorFragment frag=new EditorFragment();
        Bundle args=new Bundle();

        args.putInt(KEY_POSITION, position);
        args.putCharSequence(KEY_TEXT, text);
        frag.setArguments(args);

        return(frag);
    }
}
```

## ACTION BAR NAVIGATION

---

```
@Override
public View onCreateView(LayoutInflater inflater,
                        ViewGroup container,
                        Bundle savedInstanceState) {
    View result=inflater.inflate(R.layout.editor, container, false);

    editor=(EditText)result.findViewById(R.id.editor);

    int position=getArguments().getInt(KEY_POSITION, -1);

    editor.setHint(String.format(getString(R.string.hint), position + 1));
    editor.setText(getArguments().getCharSequence(KEY_TEXT));

    return(result);
}

CharSequence getText() {
    return(editor.getText());
}
}
```

In `onCreate()`, we tell the `ActionBar` that we want tab navigation, then we add 10 tabs to the bar:

```
ActionBar bar=getSupportActionBar();
bar.setNavigationMode(ActionBar.NAVIGATION_MODE_TABS);

for (int i=0; i < 10; i++) {
    bar.addTab(bar.newTab().setText("Tab #" + String.valueOf(i + 1))
              .setTabListener(this).setTag(i));
}

if (state != null) {
```

Calling `newTab()` on the `ActionBar` gives us an `ActionBar.Tab` object, which we can use builder-style to configure the tab. In our case, we are setting the caption (`setText()`), the listener (`setTabListener()`), and a tag to use to identify this tab (`setTag()`). The tag is akin to the tags on `Views` — it can be any object you want. In our case, we just use the index of the tab.

Our activity needs to implement the `TabListener` interface, since we are passing it into the `setTabListener()` method. There are three methods you must implement on that interface:

1. `onTabSelected()` is called when the tab is selected by the user
2. `onTabUnselected()` is called when some other tab is selected by the user

## ACTION BAR NAVIGATION

---

3. `onTabReselected()` is called, presumably, when the user taps on an already-selected tab (e.g., to refresh the tab's contents)

Our implementation ignores the latter and focuses on the first two:

```
public void onTabSelected(Tab tab, FragmentTransaction ft) {
    int i=((Integer)tab.getTag()).intValue();

    ft.replace(android.R.id.content,
               EditorFragment.newInstance(i, models[i]));
}

@Override
public void onTabUnselected(Tab tab, FragmentTransaction ft) {
    int i=((Integer)tab.getTag()).intValue();
    EditorFragment frag=
(EditorFragment)getSupportFragmentManager().findFragmentById(android.R.id.content);

    if (frag != null) {
        models[i]=frag.getText();
    }
}

@Override
public void onTabReselected(Tab tab, FragmentTransaction ft) {
    // unused
}
```

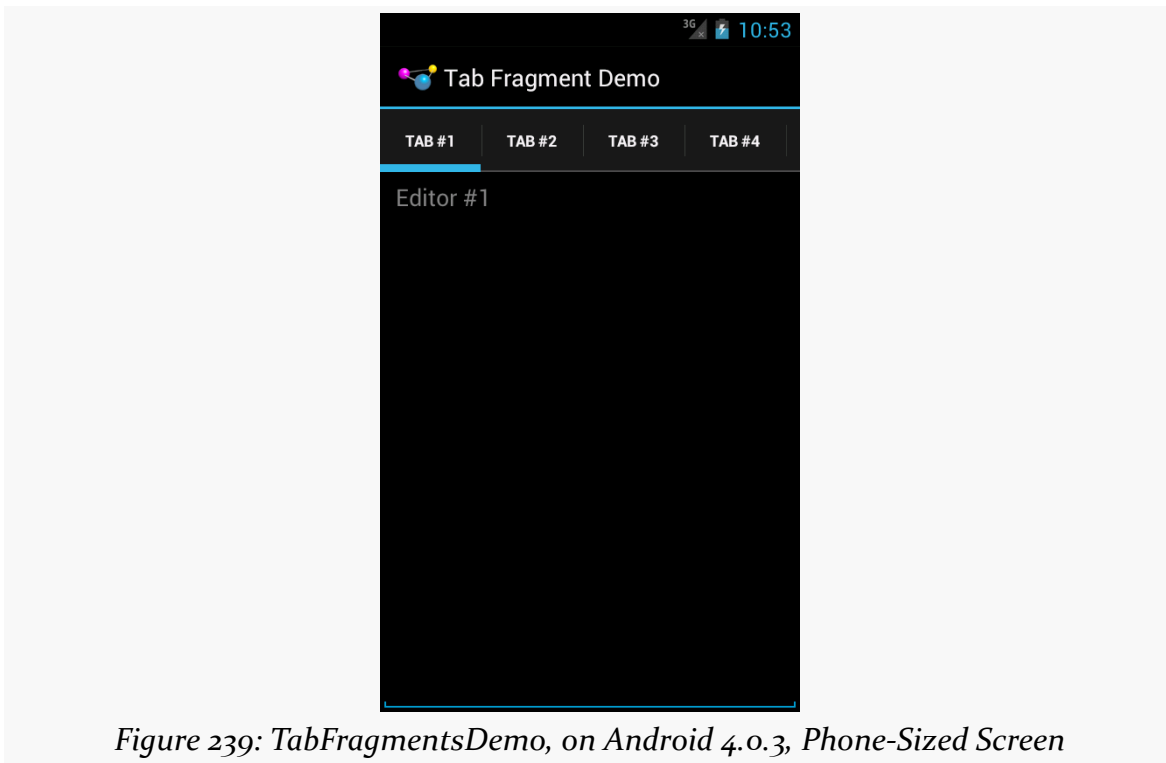
In `onTabSelected()`, we get our tab's position via its tag, then call `replace()` on the supplied `FragmentTransaction` to replace the current contents of the activity with a new `EditorFragment`, set up with the proper position and model data.

In `onTabUnselected()`, we get our tab's position and the `EditorFragment`, then save the updated text (if any) from the editor in `models` for later reuse.

Running this on a phone-sized screen gives you your tabs, in a row beneath the main action bar itself:

## ACTION BAR NAVIGATION

---

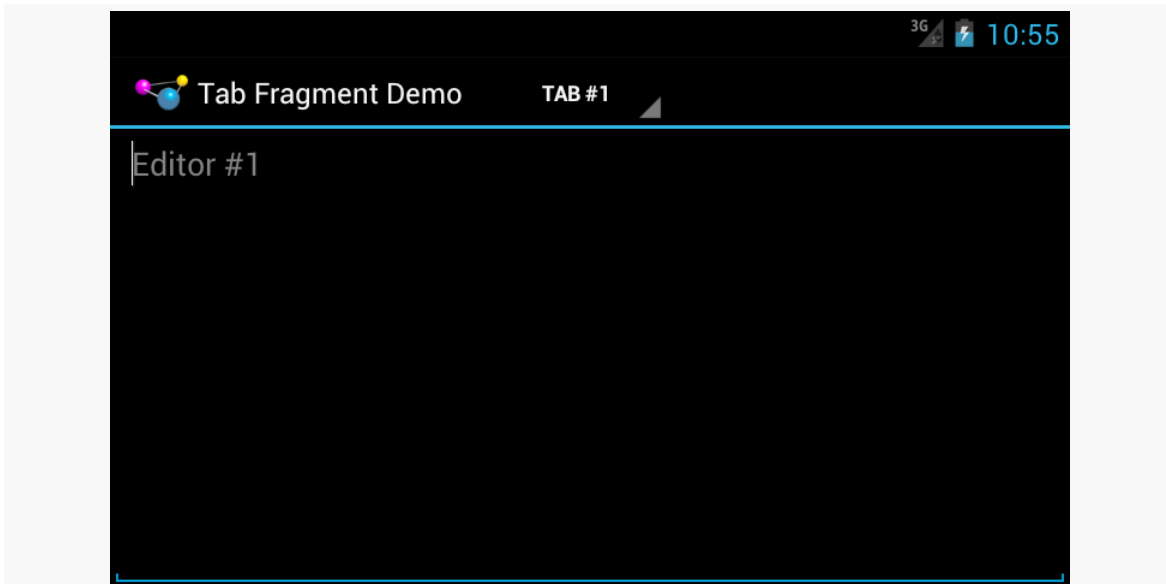


Those tabs are “swipecy”, meaning that the user can fling the row of tabs to get to all 10 of them.

This UI makes perfect sense for something described as “tab navigation”. Where things get a bit odd is in any configuration, such as a normal-sized screen in landscape:

## ACTION BAR NAVIGATION

---



*Figure 240: TabFragmentsDemo, on Android 4.0.3, Phone-Sized Screen in Landscape*

or on a large-sized screen in portrait:



*Figure 241: TabFragmentsDemo, on Android 4.0.3, Tablet-Sized Screen in Portrait*

Android will automatically convert your tab navigation to list navigation if and when it wishes to. You do not have control over this behavior, and it will vary by Android release:

The system will apply the correct UX policy for the device. As the exact policy of presentation may change on different devices or in future releases, it is intentionally not specified in documentation.

(from [the issue filed by the author of this book over this behavior](#))

## Custom Navigation

You could also elect to use one of the various flavors of `setCustomView()` on `ActionBar`. These allow you to completely control what goes in the navigation area of the bar, by supplying either a `View` or a layout resource ID that should get inflated into the bar. Particularly in the latter case, you would call `getCustomView()` later on to retrieve the inflated layout, so you can access the widgets, configure listeners, and so forth.

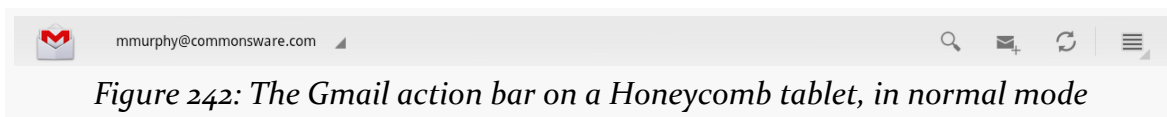
While Google definitely steers you in the direction of using the tabs or list navigation, plenty of apps will use a custom navigation option, for things like:

- a search field
- an `AutoCompleteTextView` (e.g., a browser's address bar)
- etc.

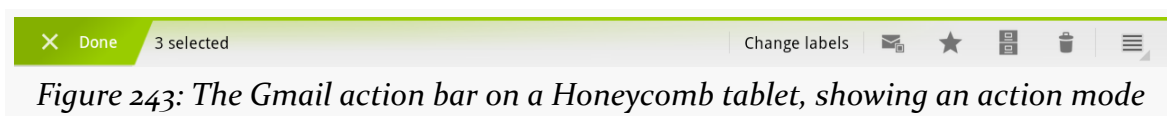
# Action Modes and Context Menus

---

If you have spent much time on an Android 3.0+ device, then you probably have run into a curious phenomenon. Sometimes, when you select an item in a list or other widget, the action bar magically transforms from its normal look:



to one designed to perform operations on what you have selected:



The good news is that this is not some sort of magic limited only to firmware applications like Gmail. You too can have this effect in your application, by triggering an “action mode”.

Action modes — sometimes called the “contextual action bar” — is the replacement for the “context menu”, whereby a menu would appear when you long-tap on some widget. Context menus were most commonly used with `AdapterViews`, particularly with `ListView`, to perform an operation on the specific long-tapped-upon item.

In this chapter, we will explore both action modes and context menus.



## Prerequisites

Understanding this chapter requires that you have read the core chapters, particularly [the one on the action bar](#).

## Another Wee Spot O' History

Most desktop operating systems have had the notion of a “context menu” for some time, typically triggered by a click of the right mouse button. In particular, a right-click over some selected item might bring up a context menu of operations to perform on that item:

- Selecting text in a text editor, then right-clicking, might bring up a context menu for cut/copy/paste of the text
- Right-clicking over a file in some sort of file explorer might bring up a context menu for cut/copy/paste of the file
- Etc.

Android supports context menus, driven by a long-tap on a widget rather than a right-click. You will find many applications that offer such menus, particularly on lists of things.

Context menus are certainly useful. Power users can save screen taps if they know where context menus reside and what features they offer. For example, rather than tapping on a list item, then opening an options menu, then tapping a menu item to delete something, a power user could long-tap to open a context menu, then tap on a context menu item — saving one tap and switching back and forth between activities.

The problem is that context menus are invisible and are triggered by an action not used elsewhere very much (long tap).

In theory, users would find out about context menus in your application from reading your documentation. That would imply that we were in some alternate universe where all users read documentation, all people live in peace and harmony, and all book authors have great heads of hair. In this universe, power users will find your context menus, but ordinary users may be completely oblivious to them. Also, the hair of book authors remains stubbornly variable.

The action bar itself is designed to help raise the visibility of what had been the options menu (e.g., turning menu items into toolbar buttons) and standardizing the location of navigation elements (e.g., tabs, search fields). The action bar takes advantage of the fact that we have a lot more screen space on a tablet than we do on a phone, and uses some of that space to consistently benefit the user.

The action mode is designed to perform a similar bit of magic for context menus. Rather than have context menus be buried under a long-tap, action modes let the contextual actions take over the action bar, putting them front-and-center in the user experience.

## Manual Action Modes

A common pattern will be to activate an action mode when the user checks off something in a multiple-choice `ListView`, as is the case with applications like Gmail. If you want to go that route, there is some built-in scaffolding to make that work, described [later in this chapter](#).

You can, if you wish, move the action bar into an action mode whenever you want. This would be particularly important if your UI is not based on a `ListView`. For example, tapping on an image in a `GridView` might activate it and move you into an action mode for operations upon that particular image.

In this section, we will examine the [ActionMode/Manual](#) sample project. This is another variation on the “show a list of nonsense words in a list” sample used elsewhere in this book.

## Choosing Your Trigger

As noted above, Gmail switches into an action mode when the user checks off one or more conversations in the conversations list. Selecting a word or passage in an `EditText` (e.g., via a long-tap) brings up an action mode for cut/copy/paste operations. And so on.

You will need to choose, for your own UI, what trigger mechanism will bring up an action mode. It should be some trigger that makes it obvious to the user what the action mode will be acting upon. For example:

1. If the user taps on the current selected item in a `Gallery` widget, bring up an action mode for operations on that particular item

## ACTION MODES AND CONTEXT MENUS

---

2. If the user long-taps on an item in a `GridView`, bring up an action mode, and treat future taps on `GridView` items as adding or removing items from the “selection” while that action mode is visible
3. If the user “rubber-bands” some figures in your vector art drawing `View`, bring up an action mode for operations on those figures (e.g., rotate, resize)

In the case of the `ActionMode` sample project, we stick with the classic long-tap on a `ListView` row to bring up an action mode that replaces the context menu when run on a API Level 11+ device:

```
@Override
public void onCreate(Bundle icle) {
    super.onCreate(icle);

    initAdapter();
    getListView().setLongClickable(true);
    getListView().setChoiceMode(ListView.CHOICE_MODE_SINGLE);
    getListView().setOnItemLongClickListener(new ActionModeHelper(
                                                this,
getListView()));
}
```

### Starting the Action Mode

Starting an action mode is trivially easy: just call `startActionMode()` on your `Activity`, passing in an implementation of `ActionMode.Callback`, which will be called with various lifecycle methods for the action mode itself.

In the case of the `ActionMode` sample project, `ActionModeHelper` – our `OnItemLongClickListener` from the preceding section – also is our `ActionMode.Callback` implementation. Hence, when the user long-clicks on an item in the `ListView`, the `ActionModeHelper` establishes itself as the action mode:

```
@Override
public boolean onItemLongClick(AdapterView<?> view, View row,
                                int position, long id) {
    modeView.clearChoices();
    modeView.setItemChecked(position, true);

    if (activeMode == null) {
        activeMode=host.startActionMode(this);
    }

    return true;
}
```

## ACTION MODES AND CONTEXT MENUS

---

Note that `startActionMode()` returns an `ActionMode` object, which we can use later on to configure the mode's behavior, by stashing it in an `actionMode` data member.

Also, we make the long-clicked-upon item be “checked”, to show which item the action mode will act upon. Our row layout will make a checked row show up with the “activated” style:

```
<?xml version="1.0" encoding="utf-8"?>
<!-- Copyright (C) 2006 The Android Open Source Project

Licensed under the Apache License, Version 2.0 (the "License");
you may not use this file except in compliance with the License.
You may obtain a copy of the License at

    http://www.apache.org/licenses/LICENSE-2.0

Unless required by applicable law or agreed to in writing, software
distributed under the License is distributed on an "AS IS" BASIS,
WITHOUT WARRANTIES OR CONDITIONS OF ANY KIND, either express or implied.
See the License for the specific language governing permissions and
limitations under the License.
-->
<TextView xmlns:android="http://schemas.android.com/apk/res/android"
    android:id="@android:id/text1"
    android:layout_width="match_parent"
    android:layout_height="wrap_content"
    android:textAppearance="?android:attr/textAppearanceLarge"
    android:gravity="center_vertical"
    android:paddingLeft="6dip"
    android:minHeight="?android:attr/listPreferredItemHeight"
    style="@style/activated"
/>
```

That style is defined for Honeycomb and higher in `res/values-v11/styles.xml`:

```
<?xml version="1.0" encoding="utf-8"?>
<resources>
    <style name="activated" parent="android:Theme.Holo">
        <item name="android:background">?android:attr/
activatedBackgroundIndicator</item>
    </style>
</resources>
```

A do-nothing version of that style is used for older devices, from `res/values/styles.xml`:

```
<?xml version="1.0" encoding="utf-8"?>
<resources>
    <style name="activated">
```

```
</style>  
</resources>
```

Also note that we only start the action mode if it is not already started.

### Implementing the Action Mode

The real logic behind the action mode lies in your `ActionMode.Callback` implementation. It is in these four lifecycle methods where you define what the action mode should look like and what should happen when choices are made in it.

#### `onCreateActionMode()`

The `onCreateActionMode()` method will be called shortly after you call `startActionMode()`. Here, you get to define what goes in the action mode. You get the `ActionMode` object itself (in case you do not already have a reference to it). More importantly, you are passed a `Menu` object, just as you get in `onCreateOptionsMenu()`. And, just like with `onCreateOptionsMenu()`, you can inflate a menu resource into the `Menu` object to define the contents of the action mode:

```
@Override  
public boolean onCreateActionMode(ActionMode mode, Menu menu) {  
    MenuInflater inflater=host.getSupportMenuInflater();  
  
    inflater.inflate(R.menu.context, menu);  
    mode.setTitle(R.string.context_title);  
  
    return(true);  
}
```

In addition to inflating our context menu resource into the action mode's menu, we also set the title of the `ActionMode`, which shows up to the right of the Done button:



*Figure 244: The ActionMode sample application's action bar on a Honeycomb tablet, showing the active action mode*

#### `onPrepareActionMode()`

If you determine that you need to change the contents of your action mode, you can call `invalidate()` on the `ActionMode` object. That, in turn, will trigger a call to

## ACTION MODES AND CONTEXT MENUS

---

`onPrepareActionMode()`, where you once again have an opportunity to configure the `Menu` object. If you do make changes, return `true` — otherwise, return `false`. In the case of `ActionModeHelper`, we take the latter approach:

```
@Override
public boolean onPrepareActionMode(ActionMode mode, Menu menu) {
    return(false);
}
```

### `onActionItemClicked()`

Just as `onCreateActionMode()` is the action mode analogue to `onCreateOptionsMenu()`, `onActionItemClicked()` is the action mode analogue to `onOptionsItemSelected()`. This will be called if the user clicks on something related to your action mode. You are passed in the corresponding `MenuItem` object (plus the `ActionMode` itself), and you can take whatever steps are necessary to do whatever the work is.

On the `ActionModeDemo` class, we have the business logic for handling the data-change operations in a `performAction()` method:

```
@SuppressWarnings("unchecked")
public boolean performAction(int itemId, int position) {
    ArrayAdapter<String> adapter=(ArrayAdapter<String>)getListAdapter();

    switch (itemId) {
        case R.id.cap:
            String word=words.get(position);

            word=word.toUpperCase();

            adapter.remove(words.get(position));
            adapter.insert(word, position);

            return(true);

        case R.id.remove:
            adapter.remove(words.get(position));

            return(true);
    }

    return(false);
}
```

And, the `onActionItemClicked()` method calls `performAction()`:

---

## ACTION MODES AND CONTEXT MENUS

---

```
@Override
public boolean onActionItemClicked(ActionMode mode, MenuItem item) {
    boolean result=
        host.performAction(item.getItemId(),
                           modeView.getCheckedItemPosition());

    if (item.getItemId() == R.id.remove) {
        activeMode.finish();
    }

    return(result);
}
```

`onActionItemClicked()` also dismisses the action mode if the user chose the “remove” item, since the action mode is no longer needed. You get rid of an active action mode by calling `finish()` on it.

### **onDestroyActionMode()**

The `onDestroyActionMode()` callback will be invoked when the action mode goes away, for any reason, such as:

1. The user clicks the Done button on the left
2. The user clicks the BACK button
3. You call `finish()` on the `ActionMode`

Here, you can do any necessary cleanup. `ActionModeHelper` tries to clean things up, notably the “checked” state of the last item long-tapped-upon:

```
@Override
public void onDestroyActionMode(ActionMode mode) {
    activeMode=null;
    modeView.clearChoices();
    modeView.requestLayout();
}
```

However, for reasons that are not yet clear, `clearChoices()` does not update the UI when called from `onDestroyActionMode()` unless you also call `requestLayout()`.

## **Multiple-Modal-Choice Action Modes**

For many cases, the best user experience will be for you to have a multiple-choice `ListView`, where checking items in that list enables an action mode for performing operations on the checked items. For this scenario, Android has a new built-in

## ACTION MODES AND CONTEXT MENUS

---

ListView choice mode, `CHOICE_MODE_MULTIPLE_MODAL`, that automatically sets up an `ActionMode` for you as the user checks and unchecks items.

To see how this works, let's examine the [ActionMode/ActionModeMC](#) sample project. This is the same project as in the preceding section, but altered to have a multiple-choice `ListView`, utilizing an action mode on Honeycomb. More importantly, though, this version of the sample uses the native API Level 11+ version of the action bar, as `ActionBarSherlock` does not support `CHOICE_MODE_MULTIPLE_MODAL` at this time.

Once again, in `onCreate()`, we need to set up the smarts for our `ListView`. This time, though, we will use `CHOICE_MODE_MULTIPLE_MODAL`:

```
@TargetApi(11)
@Override
public void onCreate(Bundle icle) {
    super.onCreate(icle);

    initAdapter();

    if (Build.VERSION.SDK_INT >= Build.VERSION_CODES.HONEYCOMB) {
        getListView().setChoiceMode(ListView.CHOICE_MODE_MULTIPLE_MODAL);
        getListView()
            .setMultiChoiceModeListener(new HCMultiChoiceModeListener(this,
getListView()));
    }
    else {
        getListView().setChoiceMode(ListView.CHOICE_MODE_MULTIPLE);
        registerForContextMenu(getListView());
    }
}
```

If we are on an API Level 11+ device, we enable `CHOICE_MODE_MULTIPLE_MODAL` for the `ListView`, and register an instance of an `HCMultiChoiceModeListener` object via `setMultiChoiceModeListener()`. This object is an implementation of the `MultiChoiceModeListener` interface that we will examine shortly.

We will discuss the non-Honeycomb branch [later in this chapter](#).

Since we now may have multiple checked items, our `performAction()` method must take this into account, capitalizing or removing all checked words:

```
@SuppressWarnings("unchecked")
public boolean performActions(MenuItem item) {
    ArrayAdapter<String> adapter=(ArrayAdapter<String>)getListAdapter();
    SparseBooleanArray checked=getListView().getCheckedItemPositions();
```



## ACTION MODES AND CONTEXT MENUS

---

```
switch (item.getItemId()) {
    case R.id.cap:
        for (int i=0;i<checked.size();i++) {
            if (checked.valueAt(i)) {
                int position=checked.keyAt(i);
                String word=words.get(position);

                word=word.toUpperCase();

                adapter.remove(words.get(position));
                adapter.insert(word, position);
            }
        }

        return(true);

    case R.id.remove:
        ArrayList<Integer> positions=new ArrayList<Integer>();

        for (int i=0;i<checked.size();i++) {
            if (checked.valueAt(i)) {
                positions.add(checked.keyAt(i));
            }
        }

        Collections.sort(positions, Collections.reverseOrder());

        for (int position : positions) {
            adapter.remove(words.get(position));
        }

        getListView().clearChoices();

        return(true);
}

return(false);
}
```

Back in the Honeycomb-or-higher code, `MultiChoiceModelListener` extends the `ActionMode.Callback` interface we used with our manual action mode earlier in this book. Hence, we need to implement all the standard `ActionMode.Callback` methods, plus a new `onItemCheckedStateChanged()` method introduced by `MultiChoiceModelListener`:

```
package com.commonware.android.actionmodemc;

import android.view.ActionMode;
import android.view.Menu;
import android.view.MenuInflater;
import android.view.MenuItem;
```

## ACTION MODES AND CONTEXT MENUS

---

```
import android.widget.AbsListView;
import android.widget.ListView;

public class HCMultiChoiceModeListener implements
AbsListView.MultiChoiceModeListener {
    ActionModeDemo host;
    ActionMode activeMode;
    ListView lv;

    HCMultiChoiceModeListener(ActionModeDemo host, ListView lv) {
        this.host=host;
        this.lv=lv;
    }

    @Override
    public boolean onCreateActionMode(ActionMode mode, Menu menu) {
        MenuInflater inflater=host.getMenuInflater();

        inflater.inflate(R.menu.context, menu);
        mode.setTitle(R.string.context_title);
        mode.setSubtitle("(1)");
        activeMode=mode;

        return(true);
    }

    @Override
    public boolean onPrepareActionMode(ActionMode mode, Menu menu) {
        return(false);
    }

    @Override
    public boolean onActionItemClicked(ActionMode mode, MenuItem item) {
        boolean result=host.performActions(item);

        updateSubtitle(activeMode);

        return(result);
    }

    @Override
    public void onDestroyActionMode(ActionMode mode) {
        activeMode=null;
    }

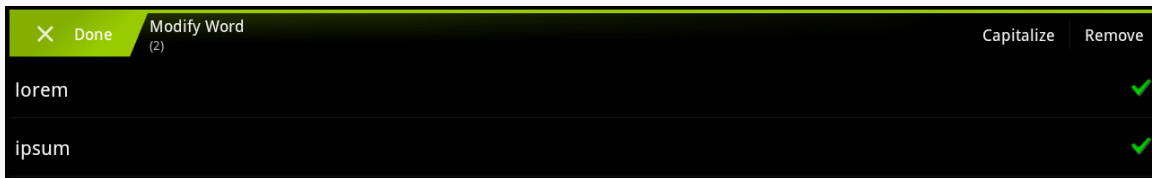
    @Override
    public void onItemCheckedStateChanged(ActionMode mode, int position,
        long id, boolean checked) {
        updateSubtitle(mode);
    }

    private void updateSubtitle(ActionMode mode) {
        mode.setSubtitle("(" + lv.getCheckedItemCount() + ")");
    }
}
```

```
}  
}
```

Android will automatically start our action mode for us when the user checks the first item in the list, using our `MultiChoiceModeListener` as the callback. Android will also automatically finish the action mode if the user unchecks all previously-checked items.

In `onCreateActionMode()`, we populate the menu, plus set up a title and subtitle on the `ActionMode`. The subtitle appears below the title, as you might expect. In this case, we are indicating how many words are checked and therefore will be affected by the actions the user chooses in the action mode:



*Figure 245: The ActionModeMC sample application's action bar on a Honeycomb tablet, showing the active action mode*

Then, in `onActionItemClicked()`, we both call `performActions()` to affect the desired changes, plus update the subtitle in case the user removed words (which means they are no longer checked).

The new `onItemCheckedStateChanged()` will be called whenever the user checks or unchecks an item, up until the last item is unchecked. `HCMultiChoiceModeListener` simply updates the subtitle to reflect the new count of checked items.

On the whole, using `CHOICE_MODE_MULTIPLE_MODAL` is simpler than setting up your own trigger mechanism and managing the action mode yourself. That being said, both are completely valid options, which is particularly important for situations where a multiple-choice `ListView` is not the desired user interface.

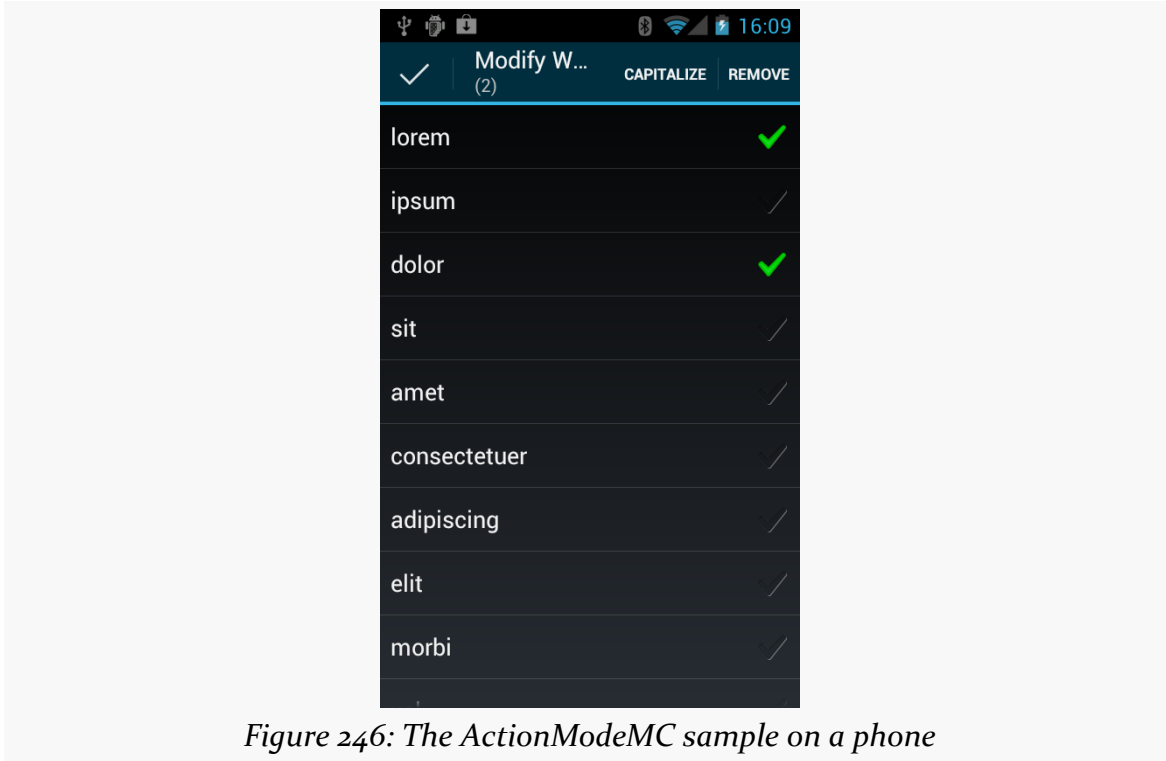
## Split Action Modes

Android 4.0 brought action modes to phone-sized devices. Small screens in the portrait orientation have problems with the action bar in general being too small. Action modes inherit the same problem.

## ACTION MODES AND CONTEXT MENUS

---

For example, here is the `ActionMode/ActionModeMC` project as seen on a Nexus S running Android 4.0.3:



*Figure 246: The ActionModeMC sample on a phone*

You will notice that our mode's title gets ellipsized due to the lack of room, and this is just with two action items. Admittedly, using icons rather than text labels would help, but even that can only get us so far.

If you use a split action bar, by adding `android:uiOptions="splitActionBarWhenNarrow"` to the `<activity>` element in the manifest, the action mode will also split, with the action items moving to the bottom:

## ACTION MODES AND CONTEXT MENUS

---



*Figure 247: The ActionModeMC sample on a phone, using a split action bar*

If there is more horizontal room (i.e., it is not “narrow”), then the action mode will display as normal:



Figure 248: The `ActionModeMC` sample on a phone, using a split action bar, in landscape orientation

## What Came Before: Context Menus

Since `ActionBarSherlock` supports manual action modes (if not the more-convenient multiple-choice action modes), you can use action modes going back to Android 2.1, which is probably more than sufficient for your needs.

However, perhaps there are situations where you truly do want a context menu, rather than the contextual action bar. You are certainly welcome to stick with the older approach. In fact, the multiple-choice action mode sample demonstrates supporting both context menus (on pre-Honeycomb devices) and action modes (on Honeycomb and higher).

## Creating a Context Menu

First, you need to indicate which widget(s) on your activity have context menus. To do this, call `registerForContextMenu()` from your activity, supplying the `View` that is the widget needing a context menu. In the case of the multiple-choice version of `ActionModeDemo`, we did this in the non-Honeycomb branch, supplying our `ListView` as the `View` in question:

```
registerForContextMenu(getListView());
```

## ACTION MODES AND CONTEXT MENUS

---

Next, you need to implement `onCreateContextMenu()`, which, among other things, is passed the `View` you supplied in `registerForContextMenu()`. You can use that to determine which menu to build, assuming your activity has more than one.

The `onCreateContextMenu()` method also gets the `ContextMenu` itself and a `ContextMenu.ContextMenuInfo`, which tells you which item in the list the user did the tap-and-hold over, in case you want to customize the context menu based on that information. For example, you could toggle a checkable menu choice based upon the current state of the item.

It is also important to note that `onCreateContextMenu()` gets called for each time the context menu is requested. Unlike the options menu (which is only built once per activity), context menus are discarded once they are used or dismissed. Hence, you do not want to hold onto the supplied `ContextMenu` object; just rely on getting the chance to rebuild the menu to suit your activity's needs on an on-demand basis based on user actions.

Beyond that, `onCreateContextMenu()` does the same sort of thing as `onCreateOptionsMenu()`: inflate a menu resource to indicate what should appear, such as is the case in `ActionModeDemo`:

```
@Override
public void onCreateContextMenu(ContextMenu menu, View v,
                               ContextMenu.ContextMenuInfo menuInfo) {
    new MenuInflater(this).inflate(R.menu.context, menu);
}
```

In this case, we are using the same menu resource as is used by the action mode.

### Responding to a Context Menu

Just as to respond to an action bar item, you implement `onOptionsItemSelected()`, to respond to a context menu item, you implement `onContextItemSelected()`:

```
@Override
public boolean onContextItemSelected(MenuItem item) {
    boolean result=performActions(item);

    if (!result) {
        result=super.onContextItemSelected(item);
    }

    return(result);
}
```

## ACTION MODES AND CONTEXT MENUS

---

As with `onOptionsItemSelected()`, you are passed the `MenuItem` that represents the context menu item that the user chose. In this case, we pass that object to the same `performActions()` method used by the action mode. If `performActions()` returns `false`, we chain to the superclass (in case a built-in context menu item was clicked).





# Advanced Uses of WebView

---

Android uses the WebKit browser engine as the foundation for both its Browser application and the WebView embeddable browsing widget. The Browser application, of course, is something Android users can interact with directly; the WebView widget is something you can integrate into your own applications for places where an HTML interface might be useful.

[Earlier in this book](#), we saw a simple integration of a WebView into an Android activity, with the activity dictating what the browsing widget displayed and how it responded to links.

Here, we will expand on this theme, and show how to more tightly integrate the Java environment of an Android application with the JavaScript environment of WebKit.

## Prerequisites

Understanding this chapter requires that you have read the core chapters, particularly the one [covering WebView](#).

## Friends with Benefits

When you integrate a WebView into your activity, you can control what Web pages are displayed, whether they are from a local provider or come from over the Internet, what should happen when a link is clicked, and so forth. And between WebView, WebViewClient, and WebSettings, you can control a fair bit about how the embedded browser behaves. Yet, by default, the browser itself is just a browser, capable of showing Web pages and interacting with Web sites, but otherwise gaining nothing from being hosted by an Android application.

## ADVANCED USES OF WEBVIEW

---

Except for one thing: `addJavascriptInterface()`.

The `addJavascriptInterface()` method on `WebView` allows you to inject a Java object into the `WebView`, exposing its methods, so they can be called by JavaScript loaded by the Web content in the `WebView` itself.

Now you have the power to provide access to a wide range of Android features and capabilities to your `WebView`-hosted content. If you can access it from your activity, and if you can wrap it in something convenient for use by JavaScript, your Web pages can access it as well.

For example, HTML5 offers geolocation, whereby the Web page can find out where the device resides, by browser-supplied means. We can do much of the same thing ourselves via `addJavascriptInterface()`.

In the [WebKit/GeoWeb1](#) project, you will find a fairly simple layout (`main.xml`):

```
<?xml version="1.0" encoding="utf-8"?>
<LinearLayout xmlns:android="http://schemas.android.com/apk/res/android"
    android:orientation="vertical"
    android:layout_width="match_parent"
    android:layout_height="match_parent"
    >
    <WebView android:id="@+id/webkit"
        android:layout_width="match_parent"
        android:layout_height="match_parent"
    />
</LinearLayout>
```

All this does is host a full-screen `WebView` widget.

Next, take a look at the `GeoWebOne` activity class:

```
package com.commonware.android.geoweb;

import android.annotation.SuppressLint;
import android.app.Activity;
import android.content.Context;
import android.location.Location;
import android.location.LocationListener;
import android.location.LocationManager;
import android.os.Bundle;
import android.webkit.JavascriptInterface;
import android.webkit.WebView;
import org.json.JSONException;
import org.json.JSONObject;

public class GeoWebOne extends Activity {
```

## ADVANCED USES OF WEBVIEW

---

```
private static String PROVIDER=LocationManager.GPS_PROVIDER;
private WebView browser;
private LocationManager myLocationManager=null;

@SuppressLint("SetJavaScriptEnabled")
@Override
public void onCreate(Bundle icle) {
    super.onCreate(icle);

    setContentView(R.layout.main);
    browser=(WebView)findViewById(R.id.webkit);

myLocationManager=(LocationManager) getSystemService(Context.LOCATION_SERVICE);

    browser.getSettings().setJavaScriptEnabled(true);
    browser.addJavascriptInterface(new Locater(), "locater");
    browser.loadUrl("file:///android_asset/geoweb1.html");
}

@Override
public void onResume() {
    super.onResume();
    myLocationManager.requestLocationUpdates(PROVIDER, 10000,
                                             100.0f,
                                             onLocation);
}

@Override
public void onPause() {
    super.onPause();
    myLocationManager.removeUpdates(onLocation);
}

LocationListener onLocation=new LocationListener() {
    public void onLocationChanged(Location location) {
        // ignore...for now
    }

    public void onProviderDisabled(String provider) {
        // required for interface, not used
    }

    public void onProviderEnabled(String provider) {
        // required for interface, not used
    }

    public void onStatusChanged(String provider, int status,
                                Bundle extras) {
        // required for interface, not used
    }
};

public class Locater {
```

## ADVANCED USES OF WEBVIEW

---

```
@JavascriptInterface
public String getLocation() throws JSONException {
    Location loc=myLocationManager.getLastKnownLocation(PROVIDER);

    if (loc==null) {
        return(null);
    }

    JSONObject json=new JSONObject();

    json.put("lat", loc.getLatitude());
    json.put("lon", loc.getLongitude());

    return(json.toString());
}
}
```

This looks a bit like some of the `WebView` examples from earlier in this book. However, it adds three key bits of code:

- It sets up the `LocationManager` to provide updates when the device position changes, routing those updates to a do-nothing `LocationListener` callback object
- It has a `Locator` inner class that provides a convenient API for accessing the current location, in the form of latitude and longitude values encoded in JSON
- It uses `addJavascriptInterface()` to expose a `Locator` instance under the name `locator` to the Web content loaded in the `WebView`

The `Locator` API uses JSON to return both a latitude and a longitude at the same time. We are limited to using data types that are in common between JavaScript and Java, so we cannot pass back the `Location` object we get from the `LocationManager`. Hence, we convert the key `Location` data into a simple JSON structure that the JavaScript on the Web page can parse.

Note that the `getLocation()` method on `Locator` has the `@JavascriptInterface` annotation. This is required of apps with `android:targetSdkVersion` set to 17 or higher, though it is a good idea to start using it anyway. With such an `android:targetSdkVersion`, in an app running on an Android 4.2 or higher device, *only* public methods with the `@JavascriptInterface` annotation will be accessible by JavaScript code. On earlier devices, or with an earlier `android:targetSdkVersion`, *all* public methods on the `Locator` object would be accessible by JavaScript, including those inherited from superclasses like `Object`.

## ADVANCED USES OF WEBVIEW

---

Note that your build target will need to be Android 4.2 or higher in order to reference the `@JavascriptInterface` annotation.

Also note that `onCreate()` has the `@SuppressWarnings("SetJavaScriptEnabled")` annotation. This overrides a Lint warning about the use of `setJavaScriptEnabled(true)`, where Lint wants to make sure that you understand the risks of allowing arbitrary JavaScript to execute inside your app. In this case, the JavaScript is code that we wrote, and so we can ensure that it is safe and sane.

The Web page itself is referenced in the source code as `file:///android_asset/geoweb1.html`, so the `GeoWeb1` project has a corresponding `assets/` directory containing `geoweb1.html`:

```
<html>
<head>
<title>Android GeoWebOne Demo</title>
<script language="javascript">
  function whereami() {
    var location=JSON.parse(locater.getLocation());

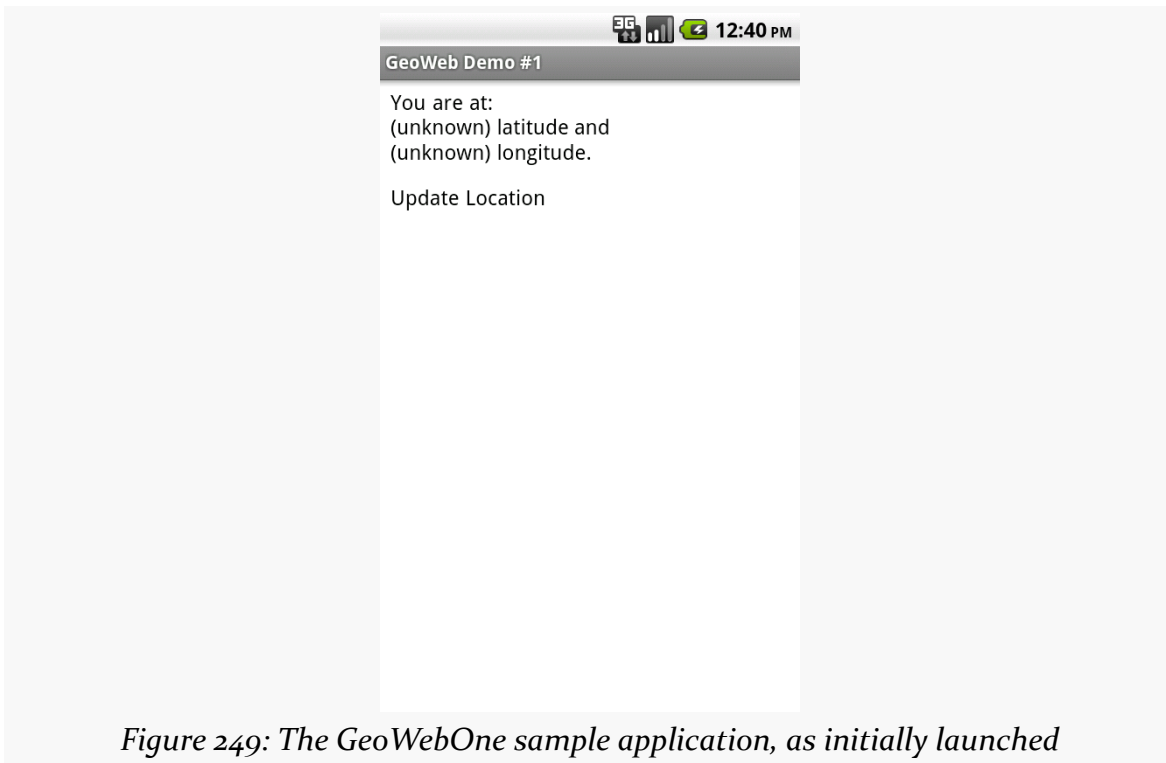
    document.getElementById("lat").innerHTML=location.lat;
    document.getElementById("lon").innerHTML=location.lon;
  }
</script>
</head>
<body>
<p>
You are at: <br/> <span id="lat">(unknown)</span> latitude and <br/>
<span id="lon">(unknown)</span> longitude.
</p>
<p><a onClick="whereami()">Update Location</a></p>
</body>
</html>
```

When you click the “Update Location” link, the page calls a `whereami()` JavaScript function, which in turn uses the `locater` object to update the latitude and longitude, initially shown as “(unknown)” on the page.

If you run the application, initially, the page is pretty boring:

## ADVANCED USES OF WEBVIEW

---



*Figure 249: The GeoWebOne sample application, as initially launched*

However, if you wait a bit for a GPS fix, and click the “Update Location” link... the page is still pretty boring, but it at least knows where you are:



*Figure 250: The GeoWebOne sample application, after clicking the Update Location link*

## Turnabout is Fair Play

Now that we have seen how JavaScript can call into Java, it would be nice if Java could somehow call out to JavaScript. In our example, it would be helpful if we could expose automatic location updates to the Web page, so it could proactively update the position as the user moves, rather than wait for a click on the “Update Location” link.

Well, as luck would have it, we can do that too. This is a good thing, otherwise, this would be a really weak section of the book.

What is unusual is how you call out to JavaScript. One might imagine there would be an `executeJavaScript()` counterpart to `addJavascriptInterface()`, where you could supply some JavaScript source and have it executed within the context of the currently-loaded Web page.

Oddly enough, that is not how this is accomplished.



## ADVANCED USES OF WEBVIEW

---

Instead, given your snippet of JavaScript source to execute, you call `loadUrl()` on your `WebView`, as if you were going to load a Web page, but you put `javascript:` in front of your code and use that as the “address” to load.

If you have ever created a “bookmarklet” for a desktop Web browser, you will recognize this technique as being the Android analogue – the `javascript:` prefix tells the browser to treat the rest of the address as JavaScript source, injected into the currently-viewed Web page.

So, armed with this capability, let us modify the previous example to continuously update our position on the Web page.

The layout for the [WebKit/GeoWeb2](#) sample project is the same as before. The Java source for our activity changes a bit:

```
package com.commonware.android.geoweb2;

import android.annotation.SuppressLint;
import android.app.Activity;
import android.content.Context;
import android.location.Location;
import android.location.LocationListener;
import android.location.LocationManager;
import android.os.Bundle;
import android.webkit.JavascriptInterface;
import android.webkit.WebView;
import org.json.JSONException;
import org.json.JSONObject;

public class GeoWebTwo extends Activity {
    private static String PROVIDER="gps";
    private WebView browser;
    private LocationManager myLocationManager=null;

    @SuppressWarnings("SetJavaScriptEnabled")
    @Override
    public void onCreate(Bundle icle) {
        super.onCreate(icle);
        setContentView(R.layout.main);
        browser=(WebView)findViewById(R.id.webkit);

myLocationManager=(LocationManager) getSystemService(Context.LOCATION_SERVICE);

        browser.getSettings().setJavaScriptEnabled(true);
        browser.addJavascriptInterface(new Locater(), "locater");
        browser.loadUrl("file:///android_asset/geoweb2.html");
    }

    @Override
```

## ADVANCED USES OF WEBVIEW

---

```
public void onResume() {
    super.onResume();
    myLocationManager.requestLocationUpdates(PROVIDER, 0,
                                             0,
                                             onLocation);
}

@Override
public void onPause() {
    super.onPause();
    myLocationManager.removeUpdates(onLocation);
}

LocationListener onLocation=new LocationListener() {
    public void onLocationChanged(Location location) {
        StringBuilder buf=new StringBuilder("javascript:whereami(");

        buf.append(String.valueOf(location.getLatitude()));
        buf.append(",");
        buf.append(String.valueOf(location.getLongitude()));
        buf.append(")");

        browser.loadUrl(buf.toString());
    }

    public void onProviderDisabled(String provider) {
        // required for interface, not used
    }

    public void onProviderEnabled(String provider) {
        // required for interface, not used
    }

    public void onStatusChanged(String provider, int status,
                                Bundle extras) {
        // required for interface, not used
    }
};

public class Locater {
    @JavascriptInterface
    public String getLocation() throws JSONException {
        Location loc=myLocationManager.getLastKnownLocation(PROVIDER);

        if (loc==null) {
            return(null);
        }

        JSONObject json=new JSONObject();

        json.put("lat", loc.getLatitude());
        json.put("lon", loc.getLongitude());

        return(json.toString());
    }
}
```

```
}  
}  
}
```

Before, the `onLocationChanged()` method of our `LocationListener` callback did nothing. Now, it builds up a call to a `whereami()` JavaScript function, providing the latitude and longitude as parameters to that call. So, for example, if our location were 40 degrees latitude and -75 degrees longitude, the call would be `whereami(40, -75)`. Then, it puts `javascript:` in front of it and calls `loadUrl()` on the `WebView`. The result is that a `whereami()` function in the Web page gets called with the new location.

That Web page, of course, also needed a slight revision, to accommodate the option of having the position be passed in:

```
<html>  
<head>  
<title>Android GeoWebTwo Demo</title>  
<script language="javascript">  
  function whereami(lat, lon) {  
    document.getElementById("lat").innerHTML=lat;  
    document.getElementById("lon").innerHTML=lon;  
  }  
  
  function pull() {  
    var location=JSON.parse(locater.getLocation());  
  
    whereami(location.lat, location.lon);  
  }  
</script>  
</head>  
<body>  
<p>  
You are at: <br/> <span id="lat">(unknown)</span> latitude and <br/>  
<span id="lon">(unknown)</span> longitude.  
</p>  
<p><a onClick="pull()">Update Location</a></p>  
</body>  
</html>
```

The basics are the same, and we can even keep our “Update Location” link, albeit with a slightly different `onClick` attribute.

If you build, install, and run this revised sample on a GPS-equipped Android device, the page will initially display with “(unknown)” for the current position. After a fix is ready, though, the page will automatically update to reflect your actual position. And, as before, you can always click “Update Location” if you wish.

## Navigating the Waters

There is no navigation toolbar with the WebView widget. This allows you to use it in places where such a toolbar would be pointless and a waste of screen real estate. That being said, if you want to offer navigational capabilities, you can, but you have to supply the UI. WebView offers ways to perform garden-variety browser navigation, including:

- `reload()` to refresh the currently-viewed Web page
- `goBack()` to go back one step in the browser history, and `canGoBack()` to determine if there is any history to go back to
- `goForward()` to go forward one step in the browser history, and `canGoForward()` to determine if there is any history to go forward to
- `goBackOrForward()` to go backwards or forwards in the browser history, where negative numbers represent a count of steps to go backwards, and positive numbers represent how many steps to go forwards
- `canGoBackOrForward()` to see if the browser can go backwards or forwards the stated number of steps (following the same positive/negative convention as `goBackOrForward()`)
- `clearCache()` to clear the browser resource cache and `clearHistory()` to clear the browsing history

## Settings, Preferences, and Options (Oh, My!)

With your favorite desktop Web browser, you have some sort of “settings” or “preferences” or “options” window. Between that and the toolbar controls, you can tweak and twiddle the behavior of your browser, from preferred fonts to the behavior of JavaScript.

Similarly, you can adjust the settings of your WebView widget as you see fit, via the `WebSettings` instance returned from calling the widget’s `getSettings()` method.

There are lots of options on `WebSettings` to play with. Most appear fairly esoteric (e.g., `setFantasyFontFamily()`). However, here are some that you may find more useful:

- Control the font sizing via `setDefaultFontSize()` (to use a point size) or `setTextSize()` (to use constants indicating relative sizes like `LARGER` and `SMALLEST`)

## ADVANCED USES OF WEBVIEW

---

- Control Web site rendering via `setUserAgent()`, so you can supply your own user agent string to make the Web server think you are a desktop browser, another mobile device (e.g., iPhone), or whatever. The settings you change are not persistent, so you should store them somewhere (such as via the Android preferences engine) if you are allowing your users to determine the settings, versus hard-wiring the settings in your application.

# The Input Method Framework

---

Android 1.5 introduced the input method framework (IMF), which is commonly referred to as “soft keyboards”. However, the “soft keyboard” term is not necessarily accurate, as IMF could be used for handwriting recognition or other means of accepting text input via the screen.

## Prerequisites

Understanding this chapter requires that you have read the core chapters, particularly the [section covering the EditText widget](#).

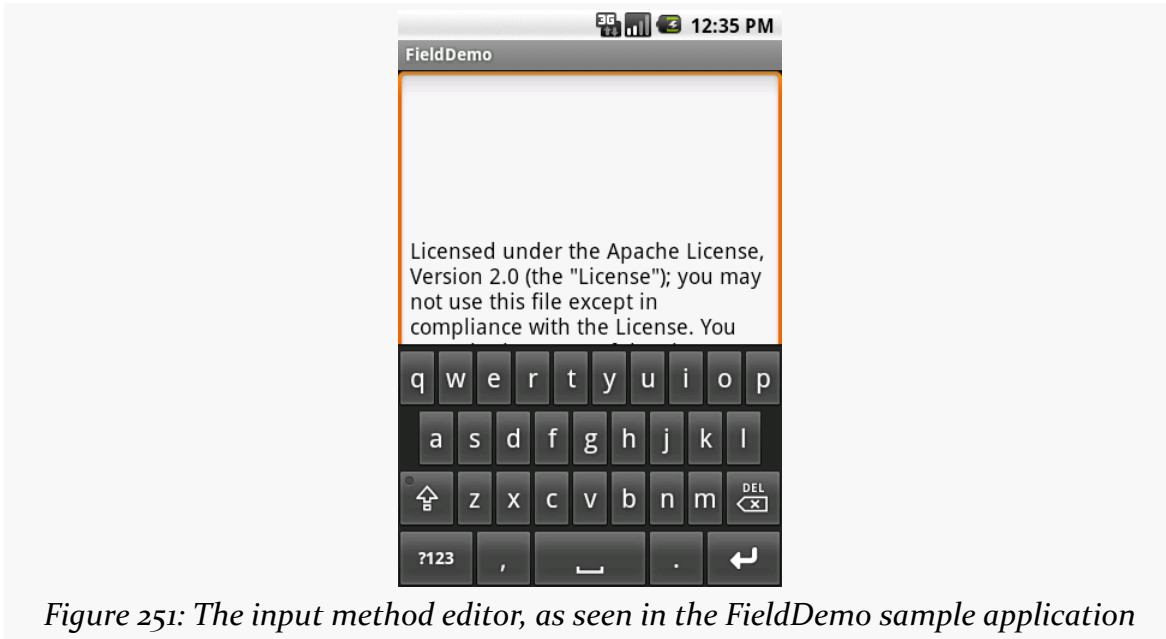
## Keyboards, Hard and Soft

Some Android devices have a hardware keyboard that is visible some of the time (when it is slid out). A few Android devices have a hardware keyboard that is always visible (so-called “bar” or “slab” phones). Most Android devices, though, have no hardware keyboard at all.

The IMF handles all of these scenarios. In short, if there is no hardware keyboard, an input method editor (IME) will be available to the user when they tap on an enabled `EditText`.

This requires no code changes to your application... if the default functionality of the IME is what you want. Fortunately, Android is fairly smart about guessing what you want, so it may be you can just test with the IME but otherwise make no specific code changes.

Of course, the keyboard may not quite behave how you would like. For example, in the Basic/Field sample project, the `FieldDemo` activity has the IME overlaying the multiple-line `EditText`:



*Figure 251: The input method editor, as seen in the FieldDemo sample application*

It would be nice to have more control over how this appears, and for other behavior of the IME. Fortunately, the framework as a whole gives you many options for this, as is described over the bulk of this chapter.

## Tailored To Your Needs

Android 1.1 and earlier offered many attributes on `EditText` widgets to control their style of input, such as `android:password` to indicate a field should be for password entry (shrouding the password keystrokes from prying eyes). Starting in Android 1.5, with the IMF, many of these have been combined into a single `android:inputType` attribute.

The `android:inputType` attribute takes a class plus modifiers, in a pipe-delimited list (where `|` is the pipe character). The class generally describes what the user is allowed to input, and this determines the basic set of keys available on the soft keyboard. The available classes are:

1. `text` (the default)

## THE INPUT METHOD FRAMEWORK

---

2. number
3. phone
4. datetime
5. date
6. time

Many of these classes offer one or more modifiers, to further refine what the user will be entering. To help explain those, take a look at the `res/layout/main.xml` file from the [InputMethod/IMEDemo1](#) project:

```
<?xml version="1.0" encoding="utf-8"?>
<TableLayout xmlns:android="http://schemas.android.com/apk/res/android"
    android:layout_width="fill_parent"
    android:layout_height="fill_parent"
    android:stretchColumns="1"
    >
    <TableRow>
        <TextView
            android:text="No special rules:"
        />
        <EditText
        />
    </TableRow>
    <TableRow>
        <TextView
            android:text="Email address:"
        />
        <EditText
            android:inputType="text|textEmailAddress"
        />
    </TableRow>
    <TableRow>
        <TextView
            android:text="Signed decimal number:"
        />
        <EditText
            android:inputType="number|numberSigned|numberDecimal"
        />
    </TableRow>
    <TableRow>
        <TextView
            android:text="Date:"
        />
        <EditText
            android:inputType="date"
        />
    </TableRow>
    <TableRow>
        <TextView
            android:text="Multi-line text:"
        />
    </TableRow>
</TableLayout>
```



## THE INPUT METHOD FRAMEWORK

---

```
<EditText
  android:inputType="text|textMultiLine|textAutoCorrect"
  android:minLines="3"
  android:gravity="top"
/>
</TableRow>
</TableLayout>
```

Here, you will see a `TableLayout` containing five rows, each demonstrating a slightly different flavor of `EditText`:

- One has no attributes at all on the `EditText`, meaning you get a plain text entry field
- One has `android:inputType = "text|textEmailAddress"`, meaning it is text entry, but specifically seeks an email address
- One allows for signed decimal numeric input, via `android:inputType = "number|numberSigned|numberDecimal"`
- One is set up to allow for data entry of a date (`android:inputType = "date"`)
- The last allows for multi-line input with auto-correction of probable spelling errors (`android:inputType = "text|textMultiLine|textAutoCorrect"`)

The class and modifiers tailor the keyboard. So, a plain text entry field results in a plain soft keyboard:



*Figure 252: A standard input method editor (a.k.a., soft keyboard)*

## THE INPUT METHOD FRAMEWORK

---

An email address field might put the @ symbol on the soft keyboard, at the cost of a smaller spacebar:



*Figure 253: The input method editor for email addresses*

Note, though, that this behavior is specific to the input method editor. Some editors might put an @ sign on the primary keyboard for an email field. Some might put a “.com” button on the primary keyboard. Some might not react at all. It is up to the implementation of the input method editor — all you can do is supply the hint.

Numbers and dates restrict the keys to numeric keys, plus a set of symbols that may or may not be valid on a given field:



*Figure 254: The input method editor for signed decimal numbers*

And so on.

By choosing the appropriate `android:inputType`, you can give the user a soft keyboard that best suits what it is they should be entering.

## Tell Android Where It Can Go

You may have noticed a subtle difference between the first and second input method editors, beyond the addition of the @ key. If you look in the lower-right corner of the soft keyboard, the second field's editor has a "Next" button, while the first field's editor has a newline button.

This points out two things:

- `EditText` widgets are multi-line by default if you do not specify `android:inputType`
- You can control what goes on with that lower-right-hand button, called the accessory button

By default, on an `EditText` where you have specified `android:inputType`, the accessory button will be "Next", moving you to the next `EditText` in sequence, or "Done", if you are on the last `EditText` on the screen. You can manually stipulate what the accessory button will be labeled via the `android:imeOptions` attribute. For

## THE INPUT METHOD FRAMEWORK

---

example, in the `res/layout/main.xml` from the [InputMethod/IMEDemo2](#) sample project, you will see an augmented version of the previous example, where two input fields specify what their accessory button should look like:

```
<?xml version="1.0" encoding="utf-8"?>
<ScrollView xmlns:android="http://schemas.android.com/apk/res/android"
    android:layout_width="fill_parent"
    android:layout_height="fill_parent"
    >
    <TableLayout
        android:layout_width="fill_parent"
        android:layout_height="fill_parent"
        android:stretchColumns="1"
        >
        <TableRow>
            <TextView
                android:text="No special rules:"
            />
            <EditText
            />
        </TableRow>
        <TableRow>
            <TextView
                android:text="Email address:"
            />
            <EditText
                android:inputType="text|textEmailAddress"
                android:imeOptions="actionSend"
            />
        </TableRow>
        <TableRow>
            <TextView
                android:text="Signed decimal number:"
            />
            <EditText
                android:inputType="number|numberSigned|numberDecimal"
                android:imeOptions="actionDone"
            />
        </TableRow>
        <TableRow>
            <TextView
                android:text="Date:"
            />
            <EditText
                android:inputType="date"
            />
        </TableRow>
        <TableRow>
            <TextView
                android:text="Multi-line text:"
            />
            <EditText
                android:inputType="text|textMultiLine|textAutoCorrect"
            />
        </TableRow>
    </TableLayout>
</ScrollView>
```

```
        android:minLines="3"
        android:gravity="top"
    />
</TableRow>
</TableLayout>
</ScrollView>
```

Here, we attach a “Send” action to the accessory button for the email address (`android:imeOptions = "actionSend"`), and the “Done” action on the middle field (`android:imeOptions = "actionDone"`).

By default, “Next” will move the focus to the next `EditText` and “Done” will close up the input method editor. However, for those, or for any other ones like “Send”, you can use `setOnEditorActionListener()` on `EditText` (technically, on the `TextView` superclass) to get control when the accessory button is clicked or the user presses the `<Enter>` key. You are provided with a flag indicating the desired action (e.g., `IME_ACTION_SEND`), and you can then do something to handle that request (e.g., send an email to the supplied email address).

## Fitting In

You will notice that the `IMEDemo2` layout shown above has another difference from its `IMEDemo1` predecessor: the use of a `ScrollView` container wrapping the `TableLayout`. This ties into another level of control you have over the input method editors: what happens to your activity’s own layout when the input method editor appears?

There are three possibilities, depending on circumstances:

1. Android can “pan” your activity, effectively sliding the whole layout up to accommodate the input method editor, or overlaying your layout, depending on whether the `EditText` being edited is at the top or bottom. This has the effect of hiding some portion of your UI.
2. Android can resize your activity, effectively causing it to shrink to a smaller screen dimension, allowing the input method editor to sit below the activity itself. This is great when the layout can readily be shrunk (e.g., it is dominated by a list or multi-line input field that does not need the whole screen to be functional).
3. In landscape mode, Android may display the input method editor full-screen, obscuring your entire activity. This allows for a bigger keyboard and generally easier data entry.

## THE INPUT METHOD FRAMEWORK

---

Android controls the full-screen option purely on its own. And, by default, Android will choose between pan and resize modes depending on what your layout looks like. If you want to specifically choose between pan and resize, you can do so via an `android:windowSoftInputMode` attribute on the `<activity>` element in your `AndroidManifest.xml` file. For example, here is the manifest from `IMEDemo2`:

```
<?xml version="1.0" encoding="utf-8"?>
<manifest xmlns:android="http://schemas.android.com/apk/res/android"
    package="com.commonware.android.imf.two"
    android:versionCode="1"
    android:versionName="1.0">

    <supports-screens
        android:anyDensity="true"
        android:largeScreens="true"
        android:normalScreens="true"
        android:smallScreens="true"/>

    <uses-sdk
        android:minSdkVersion="7"
        android:targetSdkVersion="11"/>

    <application
        android:icon="@drawable/ic_launcher"
        android:label="@string/app_name">
        <activity
            android:name=".IMEDemo2"
            android:label="@string/app_name"
            android:windowSoftInputMode="adjustResize">
            <intent-filter>
                <action android:name="android.intent.action.MAIN"/>

                <category android:name="android.intent.category.LAUNCHER"/>
            </intent-filter>
        </activity>
    </application>
</manifest>
```

Because we specified `resize`, Android will shrink our layout to accommodate the input method editor. With the `ScrollView` in place, this means the scroll bar will appear as needed:

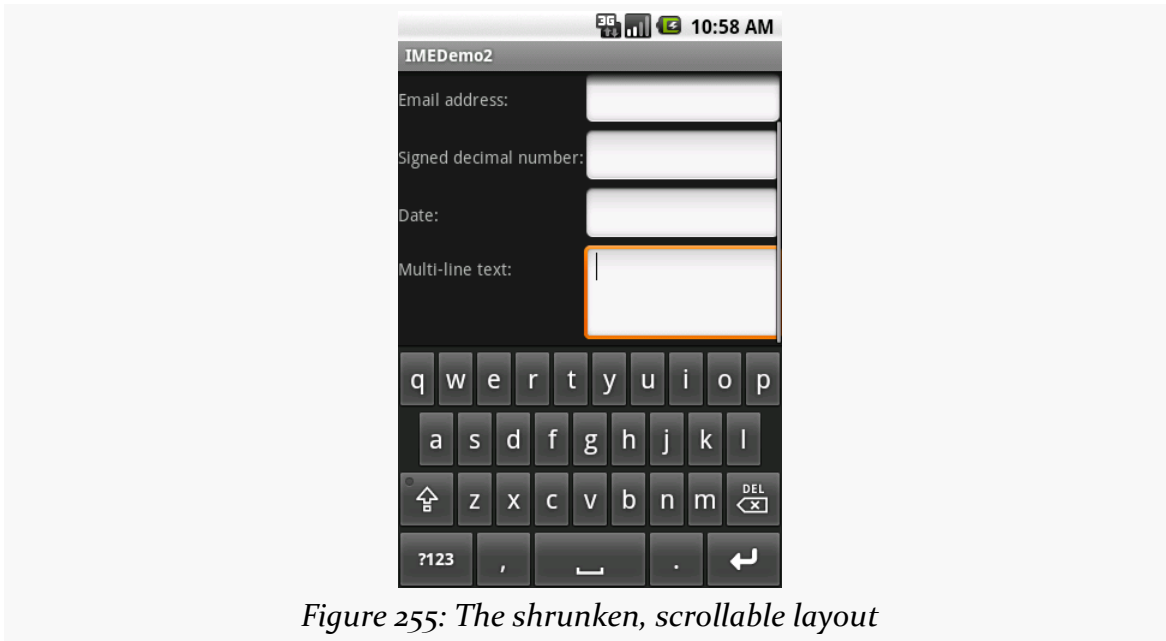


Figure 255: The shrunken, scrollable layout

## Jane, Stop This Crazy Thing!

Sometimes, you need the input method editor to just go away. For example, if you make the action button be “Search”, the user tapping that button will not automatically hide the editor.

To hide the editor, you will need to make a call to the `InputMethodManager`, a system service that controls these input method editors:

```
InputMethodManager
mgr=(InputMethodManager) getSystemService( INPUT_METHOD_SERVICE );
mgr.hideSoftInputFromWindow(fld.getWindowToken(), 0);
```

(where `fld` is the `EditText` whose input method editor you want to hide)

This will always close the input method editor. However, bear in mind that there are two ways for a user to have opened that input method editor in the first place:

- If their device does not have a hardware keyboard exposed, and they tap on the `EditText`, the input method editor should appear
- If they previously dismissed the editor, or if they are using the editor for a widget that does not normally pop one up (e.g., `ListView`), and they long-tap on the `MENU` button, the input method editor should appear

## THE INPUT METHOD FRAMEWORK

---

If you only want to close the input method editor for the first scenario, but not the second, use `InputMethodManager.HIDE_IMPLICIT_ONLY` as a flag for the second parameter to your call to `hideSoftInputFromWindow()`, instead of the 0 shown in the previous example.





Inevitably, you'll get the question "hey, can we change this font?" when doing application development. The answer depends on what fonts come with the platform, whether you can add other fonts, and how to apply them to the widget or whatever needs the font change.

Android is no different. It comes with some fonts plus a means for adding new fonts. Though, as with any new environment, there are a few idiosyncrasies to deal with.

## Prerequisites

Understanding this chapter requires that you have read the core chapters, particularly the one on [files](#).

## Love The One You're With

Android natively knows three fonts, by the shorthand names of "sans", "serif", and "monospace". For Android 1.x, 2.x, and 3.x, these fonts are actually the Droid series of fonts, created for the Open Handset Alliance by [Ascender](#). A new font set, Roboto, is used in Android 4.x and beyond.

For those fonts, you can just reference them in your layout XML, if you choose, such as the following layout from the [Fonts/FontSampler](#) sample project:

```
<?xml version="1.0" encoding="utf-8"?>
<TableLayout
  xmlns:android="http://schemas.android.com/apk/res/android"
  android:layout_width="fill_parent"
  android:layout_height="fill_parent"
  android:stretchColumns="1">
```

## FONTS

---

```
<TableRow>
  <TextView
    android:text="sans:"
    android:layout_marginRight="4dip"
    android:textSize="20sp"
  />
  <TextView
    android:id="@+id/sans"
    android:text="Hello, world!"
    android:typeface="sans"
    android:textSize="20sp"
  />
</TableRow>
<TableRow>
  <TextView
    android:text="serif:"
    android:layout_marginRight="4dip"
    android:textSize="20sp"
  />
  <TextView
    android:id="@+id/serif"
    android:text="Hello, world!"
    android:typeface="serif"
    android:textSize="20sp"
  />
</TableRow>
<TableRow>
  <TextView
    android:text="monospace:"
    android:layout_marginRight="4dip"
    android:textSize="20sp"
  />
  <TextView
    android:id="@+id/monospace"
    android:text="Hello, world!"
    android:typeface="monospace"
    android:textSize="20sp"
  />
</TableRow>
<TableRow>
  <TextView
    android:text="Custom:"
    android:layout_marginRight="4dip"
    android:textSize="20sp"
  />
  <TextView
    android:id="@+id/custom"
    android:text="Hello, world!"
    android:textSize="20sp"
  />
</TableRow>
<TableRow android:id="@+id/filerow">
  <TextView
    android:text="Custom from File:"
```

## FONTS

---

```
        android:layout_marginRight="4dip"
        android:textSize="20sp"
    />
    <TextView
        android:id="@+id/file"
        android:text="Hello, world!"
        android:textSize="20sp"
    />
</TableRow>
</TableLayout>
```

This layout builds a table showing short samples of five fonts. Notice how the first three have the `android:typeface` attribute, whose value is one of the three built-in font faces (e.g., “sans”).

The three built-in fonts are very nice. However, it may be that a designer, or a manager, or a customer wants a different font than one of those three. Or perhaps you want to use a font for specialized purposes, such as a “dingbats” font instead of a series of PNG graphics.

The easiest way to accomplish this is to package the desired font(s) with your application. To do this, simply create an `assets/` folder in the project root, and put your TrueType (TTF) fonts in the assets. You might, for example, create `assets/fonts/` and put your TTF files in there.

Then, you need to tell your widgets to use that font. Unfortunately, you can no longer use layout XML for this, since the XML does not know about any fonts you may have tucked away as an application asset. Instead, you need to make the change in Java code:

```
package com.commonware.android.fonts;

import android.app.Activity;
import android.graphics.Typeface;
import android.os.Bundle;
import android.os.Environment;
import android.view.View;
import android.widget.TextView;
import java.io.File;

public class FontSampler extends Activity {
    @Override
    public void onCreate(Bundle icle) {
        super.onCreate(icle);
        setContentView(R.layout.main);

        TextView tv=(TextView)findViewById(R.id.custom);
        Typeface face=Typeface.createFromAsset(getAssets(),
```

## FONTS

---

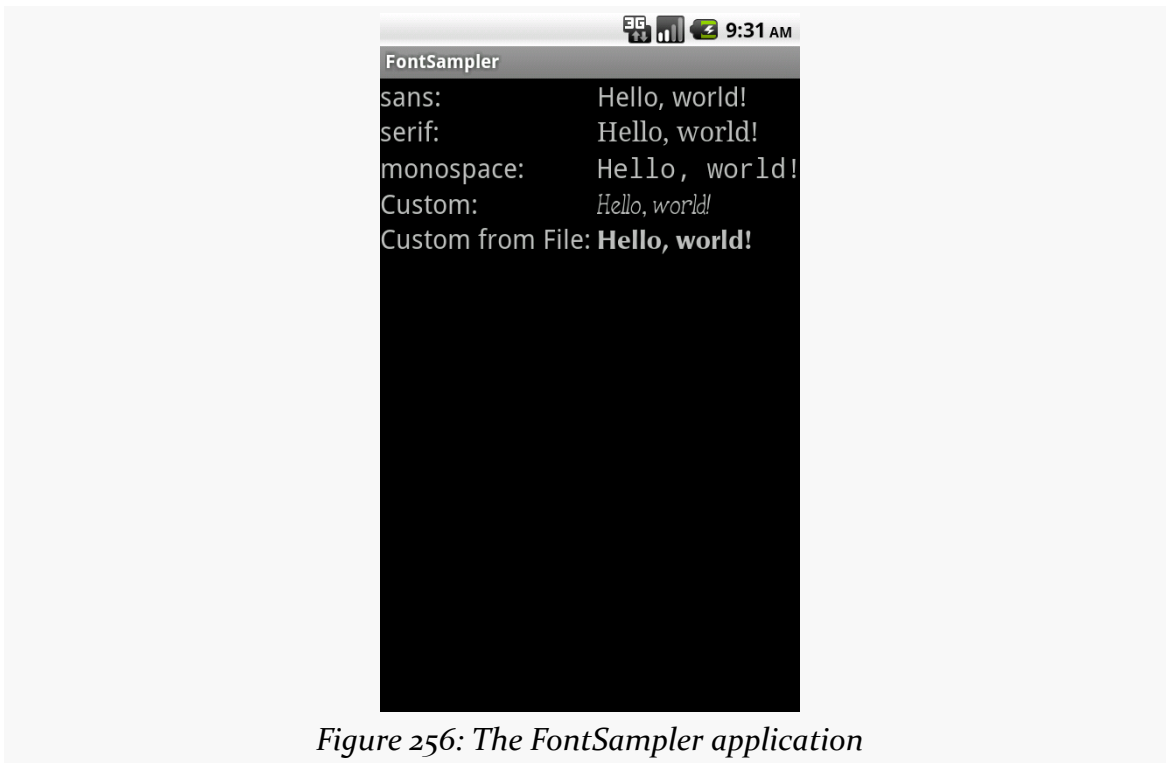
```
                "fonts/HandmadeTypewriter.ttf");  
  
        tv.setTypeface(face);  
  
        File font=new File(Environment.getExternalStorageDirectory(),  
                "MgOpenCosmeticaBold.ttf");  
  
        if (font.exists()) {  
            tv=(TextView)findViewById(R.id.file);  
            face=Typeface.createFromFile(font);  
  
            tv.setTypeface(face);  
        }  
        else {  
            findViewById(R.id.filerow).setVisibility(View.GONE);  
        }  
    }  
}
```

Here we grab the `TextView` for our “custom” sample, then create a `Typeface` object via the static `createFromAsset()` builder method. This takes the application’s `AssetManager` (from `getAssets()`) and a path within your `assets/` directory to the font you want.

Then, it is just a matter of telling the `TextView` to `setTypeface()`, providing the `Typeface` you just created. In this case, we are using the [Handmade Typewriter](#) font.

You can also load a font out of a local file and use it. The benefit is that you can customize your fonts after your application has been distributed. On the other hand, you have to somehow arrange to get the font onto the device. But just as you can get a `Typeface` via `createFromAsset()`, you can get a `Typeface` via `createFromFile()`. In our `FontSampler`, we look in the root of “external storage” (typically the SD card) for the `MgOpenCosmeticaBold` TrueType font file, and if it is found, we use it for the fifth row of the table. Otherwise, we hide that row.

The results?



*Figure 256: The FontSampler application*

Note that Android does not seem to like all TrueType fonts. When Android dislikes a custom font, rather than raise an Exception, it seems to substitute Droid Sans (“sans”) quietly. So, if you try to use a different font and it does not seem to be working, it may be that the font in question is incompatible with Android, for whatever reason.

## Here a Glyph, There a Glyph

TrueType fonts can be rather pudgy, particularly if they support an extensive subset of the available Unicode characters. The Handmade Typewriter font used above runs over 70KB; the DejaVu free fonts can run upwards of 500KB apiece. Even compressed, these add bulk to your application, so be careful not to go overboard with custom fonts, lest your application take up too much room on your users’ phones.

Conversely, bear in mind that fonts may not have all of the glyphs that you need. As an example, let us talk about the ellipsis.

## FONTS

---

Android's `TextView` class has the built-in ability to “ellipsize” text, truncating it and adding an ellipsis if the text is longer than the available space. You can use this via the `android:ellipsize` attribute, for example. This works fairly well, at least for single-line text.

The ellipsis that Android uses is not three periods. Rather it uses an actual ellipsis character, where the three dots are contained in a single glyph. Hence, any font that you use in a `TextView` where you also use the “ellipsizing” feature will need the ellipsis glyph.

Beyond that, though, Android pads out the string that gets rendered on-screen, such that the length (in characters) is the same before and after “ellipsizing”. To make this work, Android replaces one character with the ellipsis, and replaces all other removed characters with the Unicode character ‘ZERO WIDTH NO-BREAK SPACE’ (U+FEFF). This means the “extra” characters after the ellipsis do not take up any visible space on screen, yet they can be part of the string.

However, this means any custom fonts you use for `TextView` widgets that you use with `android:ellipsize` must also support this special Unicode character. Not all fonts do, and you will get artifacts in the on-screen representation of your shortened strings if your font lacks this character (e.g., rogue X's appear at the end of the line).

And, of course, Android's international deployment means your font must handle any language your users might be looking to enter, perhaps through a language-specific input method editor.

Hence, while using custom fonts in Android is very possible, there are many potential problems, and so you must weigh carefully the benefits of the custom fonts versus their potential costs.

Plain text is so, well, plain.

Fortunately, Android has fairly extensive support for formatted text, before you need to break out something as heavy-weight as `WebView`. However, some of this rich text support has been shrouded in mystery, particularly how you would allow users to edit formatted text.

This chapter will explain how the rich text support in Android works and how you can take advantage of it, with particular emphasis on some open source projects to help you do just that.

## Prerequisites

Understanding this chapter requires that you have read the core chapters, particularly the ones on [basic widgets](#) and the [input method framework](#).

## The Span Concept

You may have noticed that many methods in Android accept or return a `CharSequence`. The `CharSequence` interface is little used in traditional Java, if for no other reason than there are relatively few implementations of it outside of `String`. However, in Android, `CharSequence` becomes much more important, because of a sub-interface named `Spanned`.

`Spanned` defines sequences of characters (`CharSequence`) that contain *inline markup rules*. These rules — instances of `CharacterStyle` — indicate whether the “spanned”



portion of the characters should be rendered in an alternate font, or be turned into a hyperlink, or have other effects applied to them.

Methods that take a `CharSequence` as a parameter, therefore, can work equally well with `String` objects as well as objects that implement `Spanned`.

### Implementations

The base interface for rich-text `CharSequence` objects is `Spanned`. This is used for any `CharSequence` that has inline markup rules, and it defines methods for retrieving markup rules applied to portions of the underlying text.

The primary concrete implementation of `Spanned` is `SpannedString`. `SpannedString`, like `String`, is immutable — you cannot change either the text or the formatting of a `SpannedString`.

There is also the `Spannable` sub-interface of `Spanned`. `Spannable` is used for any `CharSequence` with inline markup rules that can be modified, and it defines the methods for modifying the formatting. There is a corresponding `SpannableString` implementation.

Finally, there is a related `Editable` interface, which is for a `CharSequence` that can have its *text* modified in-place. `SpannableStringBuilder` implements both `Editable` and `Spannable`, for modifying text and formatting at the same time.

### TextView and Spanned

One of the most important uses of `Spanned` objects is with `TextView`. `TextView` is capable of rendering a `Spanned`, complete with all of the specified formatting. So, if you have a `Spanned` that indicates that the third word should be rendered in italics, `TextView` will faithfully italicize that word.

`TextView`, of course, is an ancestor of many other widgets, from `EditText` to `Button` to `CheckBox`. Each of those, therefore, can use and render `Spannable` objects. The fact that `EditText` has the ability to render `Spanned` objects — and even allow them to be edited — is key for allowing users to enter rich text themselves as part of your UI.

### Available Spans

As noted above, the markup rules come in the form of instances of a base class known as `CharacterStyle`. Despite that name, all of the SDK-supplied subclasses of `CharacterStyle` end in `Span` (not `Style`), and so you will likely see references to these as “spans” as often as “styles”. That also helps minimize confusion between character styles and style resources.

There are well over a dozen supplied `CharacterStyle` subclasses, including:

1. `ForegroundColorSpan` and `BackgroundColorSpan` for coloring text
2. `StyleSpan`, `TextAppearanceSpan`, `TypefaceSpan`, `UnderlineSpan`, and `StrikethroughSpan` for affecting the true “style” of text
3. `AbsoluteSizeSpan`, `RelativeSizeSpan`, `SuperscriptSpan`, and `SubscriptSpan` for affecting the size (and, in some cases, vertical position) of the text

And so on.

In principle, you could implement your own custom subclasses of `CharacterStyle`, though coverage of this is well outside the scope of this book.

### Loading Rich Text

Spanned objects do not appear by magic. Plenty of things in Java will give you ordinary strings, from XML and JSON parsers to loading data out of a database to simply hard-coding string constants. However, there are only a few ways that you as a developer will get a `Spanned` complete with formatting, and that includes you creating such a `Spanned` yourself by hand.

### String Resource

The primary way most developers get a `Spanned` object into their application is via a string resource. String resources support inline markup in the form of HTML tags. Bold (`<b>`), italics (`<i>`), and underline (`<u>`) are officially supported, such as:

```
<string name="welcome">Welcome to <b>Android</b>!</string>
```

When you retrieve the string resource via `getText()`, you get back a `CharSequence` that represents a `Spanned` object with the markup rules in place.

### HTML

The next-most common way to get a Spanned object is to use `Html.fromHtml()`. This parses an HTML string and returns a Spanned object, with all recognized tags converted into corresponding spans. You might use this for text loaded from a database, retrieved from a Web service call, extracted from an RSS feed, etc.

Unfortunately, the list of tags that `fromHtml()` understands is undocumented. Based upon the source code to `fromHtml()`, the following seem safe:

1. `<a href="...">`
2. `<b>`
3. `<big>`
4. `<blockquote>`
5. `<br>`
6. `<cite>`
7. `<dfn>`
8. `<div align="...">`
9. `<em>`
10. `<font size="..." color="..." face="...">`
11. `<h1>`
12. `<h2>`
13. `<h3>`
14. `<h4>`
15. `<h5>`
16. `<h6>`
17. `<i>`
18. ``
19. `<p>`
20. `<small>`
21. `<strike>`
22. `<strong>`
23. `<sub>`
24. `<sup>`
25. `<tt>`
26. `<u>`

However, do bear in mind that these are undocumented and therefore are subject to change. Also note that `fromHtml()` is perhaps slower than you might think, particularly for longer strings.

You might also wind up using some other support code to get your HTML. For example, some data sources might publish text formatted as [Markdown](#) — StackOverflow, GitHub, etc. use this extensively. Markdown can be converted to HTML, through any number of available Java libraries or via [cwac-anddown](#), which wraps the native [sundown](#) Markdown->HTML converter for maximum speed.

### From EditText

The reason why so much sample code calls `getText()` followed by `toString()` on an `EditText` widget is because `EditText` is going to return an `Editable` object from `getText()`, not a simple string. That's because, in theory, `EditText` could be returning something with formatting applied. The call to `toString()` simply strips out any potential formatting as part of giving you back a `String`.

However, you could elect to use the `Editable` object (presumably a `SpannableStringBuilder`) if you wanted, such as for pouring the entered text into a `TextView`, complete with any formatting that might have wound up on the entered text.

Actually getting formatting applied to the contents of an `EditText` is covered [later in this chapter](#).

### Manually

You are welcome to create a `SpannableString` via its constructor, supplying the text that you wish to display, then calling various methods on `SpannableString` to format it. We will see an example of this [later in this chapter](#).

Or, you are welcome to create a `SpannableStringBuilder` via its constructor. In some respects, `SpannableStringBuilder` works like the classic `StringBuilder` — you call `append()` to add more text. However, `SpannableStringBuilder` also offers `delete()`, `insert()`, and `replace()` methods to modify portions of the existing content. It also supports the same methods that `SpannableString` does, via the `Spannable` interface, for applying formatting rules to portions of text.

### Editing Rich Text

If the `Spannable` you wound up with is a `SpannedString`, it is what it is — you cannot change it. If, however, you have a `SpannableString`, that can be modified by

you, or by the user. Of course, allowing the user to modify a `Spannable` gets a wee bit tricky, and is why the `RichEditText` project was born.

### RichEditText

If you load a `Spannable` into an `EditText`, the formatting will not only be displayed, but it will be part of the editing experience. For example, if the phrase “*the fox jumped*” is in bold, and the user adds in more words to make it “*the quick brown fox jumped*”, the additional words will also be in boldface. That is because the user is modifying text in the middle of a defined span, and so therefore the adjusted text is rendered according to that span.

The biggest problem is that `EditText` alone has no mechanism to allow users to *change* formatting. Perhaps someday it will have options for that. In the meantime, though, `RichEditText` is designed to fill that gap.

[RichEditText is a CWAC project](#) that offers a reasonably convenient API for applying, toggling, or removing effects applied to the current selected text. You have your choice of creating your own UI for this (e.g., implementing a toolbar) or enabling an extension to the `EditText` action modes to allow the users to format the text.

More information on using `RichEditText` can be found on [the project site](#), and a future version of this chapter will go into details not only of its use, but also its construction, once the project has matured a little more.

### Manually

`Spannable` offers two methods for modifying its formatting: `setSpan()` to apply formatting, and `removeSpan()` to get rid of an existing span. And, since `Spannable` extends `Spanned`, a `Spannable` also has `getSpans()`, to return existing spans of a current type within a certain range of characters in the text. These methods, along with others on `Spanned`, allow you to get and set whatever formatting you wish to apply on a `Spannable` object, such as a `SpannableString`.

For example, let’s take a look at the [RichText/Search](#) sample project. Here, we are going to load some text into a `TextView`, then allow the user to enter a search string in an `EditText`, and we will use the `Spannable` methods to highlight the search string occurrences inside the text in the `TextView`.

Our layout is simply an `EditText` atop a `TextView` (wrapped in a `ScrollView`):

## RICH TEXT

---

```
<?xml version="1.0" encoding="utf-8"?>
<LinearLayout xmlns:android="http://schemas.android.com/apk/res/android"
    android:layout_width="fill_parent"
    android:layout_height="fill_parent"
    android:orientation="vertical">

    <EditText
        android:id="@+id/search"
        android:layout_width="fill_parent"
        android:layout_height="wrap_content"
        android:singleLine="true">

        <requestFocus/>
    </EditText>

    <ScrollView
        android:id="@+id/scroll"
        android:layout_width="fill_parent"
        android:layout_height="fill_parent">

        <TextView
            android:id="@+id/prose"
            android:layout_width="fill_parent"
            android:layout_height="wrap_content"
            android:text="@string/address"
            android:textAppearance="?android:attr/textAppearanceMedium"/>
    </ScrollView>
</LinearLayout>
```

We pre-fill the `TextView` with a string resource (`@string/address`), which in this project is the text of Lincoln's Gettysburg Address, with a bit of inline markup (e.g., "Four score and seven years ago" italicized). So, when we fire up the project at the outset, we see the formatted prose from the string resource:

## RICH TEXT

---

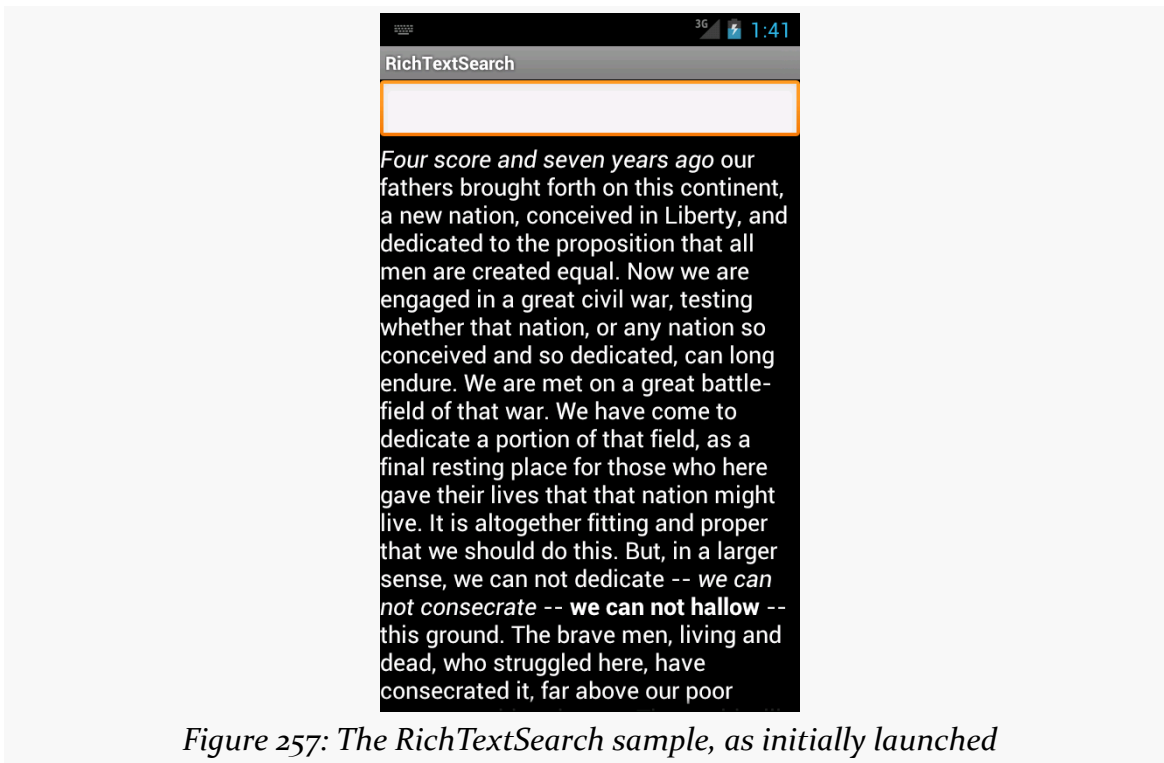


Figure 257: The RichTextSearch sample, as initially launched

In `onCreate()` of our activity, we find the `EditText` widget and designate the activity itself as being an `OnEditorActionListener` for the `EditText`:

```
@Override
public void onCreate(Bundle savedInstanceState) {
    super.onCreate(savedInstanceState);
    setContentView(R.layout.main);

    search=(EditText)findViewById(R.id.search);
    search.setOnEditorActionListener(this);
}
```

That means when the user presses <Enter>, we will get control in an `onEditorAction()` method. There, we pass the search text to a private `searchFor()` method, plus ensure that the input method editor is hidden (if one was used to fill in the search text):

```
@Override
public boolean onEditorAction(TextView v, int actionId, KeyEvent event) {
    if (event == null || event.getAction() == KeyEvent.ACTION_UP) {
        searchFor(search.getText().toString());

        InputMethodManager imm=
            (InputMethodManager) getSystemService(INPUT_METHOD_SERVICE);
```

## RICH TEXT

---

```
    imm.hideSoftInputFromWindow(v.getWindowToken(), 0);
}

return(true);
}
```

The `searchFor()` method is where the formatting is applied to our search text:

```
private void searchFor(String text) {
    TextView prose=(TextView)findViewById(R.id.prose);
    Spannable raw=new SpannableString(prose.getText());
    BackgroundColorSpan[] spans=raw.getSpans(0,
                                           raw.length(),
                                           BackgroundColorSpan.class);

    for (BackgroundColorSpan span : spans) {
        raw.removeSpan(span);
    }

    int index=TextUtils.indexOf(raw, text);

    while (index >= 0) {
        raw.setSpan(new BackgroundColorSpan(0xFF8B008B), index, index
                + text.length(), Spanned.SPAN_EXCLUSIVE_EXCLUSIVE);
        index=TextUtils.indexOf(raw, text, index + text.length());
    }

    prose.setText(raw);
}
```

First, we get a `Spannable` object out of the `TextView`. While an `EditText` returns an `Editable` from `getText()`, `getText()` on a `TextView` returns a `CharSequence`. In particular, the first time we execute `searchFor()`, `getText()` will return a `SpannedString`, as that is what a string resource turns into. However, that is not modifiable, so we convert it into a `SpannableString` so we can apply formatting to it. An optimization would be to see if `getText()` returns something implementing `Spannable` and then just using it directly.

We want to highlight the search terms using a `BackgroundColorSpan`. However, that means we first need to get rid of any existing `BackgroundColorSpan` objects applied to the prose from a previous search — otherwise, we would keep highlighting more and more of the prose. So, we use `getSpans()` to find all `BackgroundColorSpan` objects anywhere in the prose (from index 0 through the length of the text). For each that we find, we call `removeSpan()` to get rid of it from our `Spannable`.

Then, we use `indexOf()` on `TextUtils` to find the first occurrence of whatever the user typed into the `EditText`. If we find it, we create a new `BackgroundColorSpan`



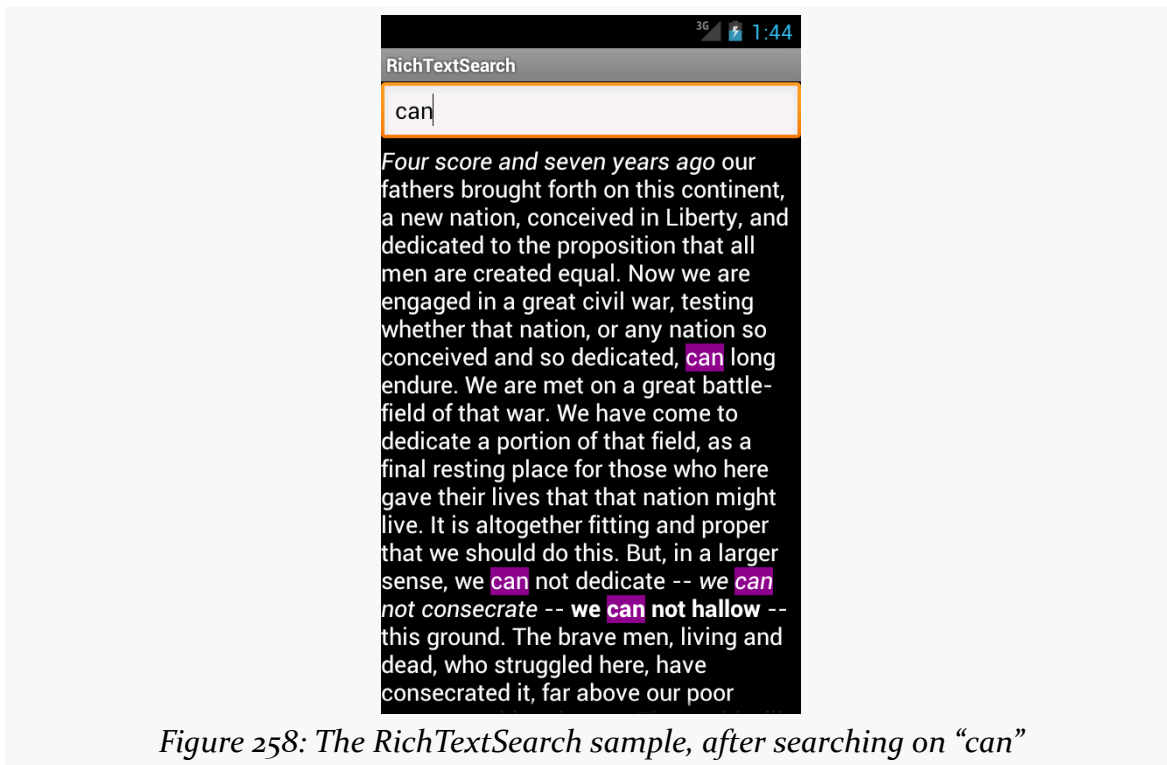
## RICH TEXT

---

and apply it to the matching portion of the prose using `setSpan()`. The last parameter to `setSpan()` is a flag, indicating what should happen if text is inserted at either the starting or ending point. In our case, the text itself is remaining constant, so the flag does not matter much – here, we use `SPAN_EXCLUSIVE_EXCLUSIVE`, which would mean that the span would not cover any text inserted at the starting or ending point of the span.

We then continue using `indexOf()` to find any remaining occurrences of the search text. Once we are done modifying our `Spannable`, we put it into the `TextView` via `setText()`.

The result is that all matching substrings are highlighted in a purple/magenta shade:



*Figure 258: The RichTextSearch sample, after searching on “can”*

## Saving Rich Text

`SpannableString` and `SpannedString` are not `Serializable`. There is no built-in way to persist them directly.

However, `Html.toHtml()` will convert a `Spanned` object into corresponding HTML, for all `CharacterStyle` objects that can be readily converted into HTML. You can then persist the resulting HTML any place you would persist a `String` (e.g., database column).

In principle, you could create other similar conversion code, such as something to take a `Spanned` and return the corresponding Markdown source.

## Manipulating Rich Text

The `TextUtils` class has many utility methods that manipulate a `CharSequence`, to allow you to do things that you might ordinarily have done just with methods on `String`. These utility methods will work with any `CharSequence`, including `SpannedString` and `SpannableString`.

Some are specifically aimed at `Spanned` objects, such as `copySpansFrom()` (to apply formatting from one `CharSequence` onto another). Some are clones of `String` equivalents, such as `split()`, `join()`, and `substring()`. Yet others are designed for developers using the Canvas 2D drawing API, such as `ellipse()` and `commaEllipsize()` for intelligently truncating messages.



# Mapping with Maps V2

---

One of Google's most popular services — after search, of course — is Google Maps, where you can find everything from the nearest pizza parlor to directions from New York City to San Francisco (only 2,905 miles!) to street views and satellite imagery.

Android has had mapping capability from the beginning, with an API available to us as developers to bake maps into our apps. However, as we will [see shortly](#), that original API was getting a bit stale.

In December 2012, Google released a long-awaited update to the mapping capabilities available to Android app developers. The original mapping solution, now known as the Maps V1, worked but had serious limitations. The new mapping solution, known as Maps V2, offers greater power and greater ease of handling common situations, though it too has its rough edges.

This chapter is focused on Maps V2, which is what you should consider for new application development. You can also find coverage of Maps V1 [in another chapter of this book](#).

## Prerequisites

Understanding this chapter requires that you have read the core chapters, along with [the chapter on drawables](#). Many of the samples also employ [list navigation in the action bar](#) — while this is not needed to use Maps V2, knowing that material will help you understand a bit of how the samples work. Also, one of the samples involves [location tracking](#).

This chapter also makes the occasional reference back to Maps V1 for comparisons, mostly for the benefit of developers already familiar with Maps V1 and looking to

migrate to Maps V2. You are certainly welcome to read the [Maps V1 chapter](#), though it should not be required to understand this chapter.

## A Brief History of Mapping on Android

Back in the dawn of Android, we were given the Maps SDK add-on. This would allow us to load a firmware-hosted mapping library into our applications, then embed maps into our activities, by means of a MapView widget.

And it worked.

More importantly, from the standpoint of users, the results from our apps were visually indistinguishable from the built-in Maps application available on devices that had the Maps SDK add-on.

This was the case through most of 2009. Eventually, though, the Google Maps team wanted to update the Maps application... but, for whatever reason, the decision was made to *not* update the Maps SDK add-on as well. At this point, the Google Maps team effectively forked the Maps SDK add-on, causing the Maps application to diverge from what other Android app developers could deliver. Over time, this feature gap became quite pronounced.

The release of Android 3.0 in early 2011 compounded the problems. Now, we needed to consider using fragments to help manage our code and deliver solutions to all screen sizes. Alas, while we could add maps to our fragments, we could only do so on API Level 11 or higher — the fragments backport from the Android Support package did not work with the Maps SDK add-on.

The release of Maps V2 helped all of this significantly. Now we have proper map support for native and backported versions of the fragment framework. We also have a look and feel that is closer to what the Maps application itself supports. While we still cannot reach feature parity with the Maps application, our SDK apps can at least look like they belong on the same device as the Maps application.

## Where You Can Use Maps V2

Many devices will be able to use Maps V2... but not all. Notably:

- Devices need to support OpenGL ES V2, to handle the new vector-based tiles that Maps V2 uses. [Over 90% of Android devices](#) in use today that support

the Play Store (or its “Android Market” predecessor) also support OpenGL ES V2.

- Devices will need an update to the Google Services Framework that accompanies the Play Store. Devices that do not have the Play Store — either because they are forever stuck on the old Android Market or, like the Kindle Fire, never had Play Store support in the first place — will be unable to use Maps V2.

We will examine what it takes to support both the legacy maps and Maps V2 in the same app [later in this chapter](#). Also, [later in this chapter](#), we will look at other mapping libraries that you could use instead of either of Google’s mapping solutions.

For many developers, the biggest limitation at the present time is that Maps V2 does not work on the Android emulators. It is unclear if and when emulator support will be added. While there are recipes online for hacking Maps V2 support into an emulator, these recipes rely upon pirated versions of various pieces of Google software and therefore are not recommended.

## Licensing Terms for Maps V2

As with the original Maps SDK add-on, to use Maps V2, you must agree to [a terms of service agreement](#) to be authorized to embed Google Maps within your application. If you intend to use Maps V2, you should review these terms closely, as they place many restrictions on developers. The most notorious of these is that you cannot use Maps V2 to create an application that offers “real time navigation or route guidance, including but not limited to turn-by-turn route guidance that is synchronized to the position of a user’s sensor-enabled device.”

If you find these terms to be an issue for your application, you may need to consider [alternative mapping solutions](#).

## What You Need to Start

If you wish to use Maps V2 in one or more of your Android applications, this section will outline what you need to get started.

### Your Signing Key Fingerprint(s)

As with the legacy Maps SDK add-on, you will need fingerprints of your app signing keys, to tie your apps to your Google account and the API keys you will be generating. However, unlike the legacy Maps SDK add-on, the fingerprints you will be using will be created using the SHA-1 hash algorithm, rather than MD5.

First, you will need to know where the keystore is for your signing key. For a production keystore that you created yourself for your production apps, you should know where it is located already. For the debug keystore, used by default during development, the location is dependent upon operating system:

- OS X and Linux: `~/ .android/debug.keystore`
- Windows XP: `C:\Documents and Settings\%USER\.android\debug.keystore`
- Windows Vista and Windows 7: `C:\Users\%USER\.android\debug.keystore`

(where `%USER` is your Windows user name)

You will then need to run the `keytool` command, to dump information related to this keystore. The `keytool` command is in your Java SDK, not the Android SDK. You will need to run this from a command line (e.g., Command Prompt in Windows). The specific command to run is:

```
keytool -list -v -keystore ... -alias androiddebugkey -storepass android
-keypass android
```

where the `...` is replaced by the path to your keystore, enclosed in quotation marks if the path contains spaces.

This should emit output akin to:

```
Alias name: androiddebugkey
Creation date: Aug 7, 2011
Entry type: PrivateKeyEntry
Certificate chain length: 1
Certificate[1]:
Owner: CN=Android Debug, O=Android, C=US
Issuer: CN=Android Debug, O=Android, C=US
Serial number: 4e3f2684
Valid from: Sun Aug 07 19:57:56 EDT 2011 until: Tue Jul 30 19:57:56 EDT 2041
Certificate fingerprints:
  MD5:  98:84:0E:36:F0:B3:48:9C:CD:13:EB:C6:D8:7F:F3:B1
  SHA1: E6:C5:81:EB:8A:F4:35:B0:04:84:3E:6E:C3:88:BD:B2:66:52:E7:09
```

## MAPPING WITH MAPS V2

---

```
Signature algorithm name: SHA1withRSA
Version: 3
```

You will need to make note of the SHA1 entry (see third line from the bottom of the above sample).

### Your Google Account

To sign up for an API key, you need a Google account. Ideally, this account would be the same one you intend to use for submitting apps to the Play Store (if, indeed, you intend to do so).

### Your API Key

Given that you are logged into the aforementioned Google account, you can visit [the Google APIs Console](#) to request access to the Maps V2 API. To do this:

- Create a project via the “Create project” option, if you have not done so already for something else (e.g., [GCM](#))
- Open your project, then select Services from the left navigation bar
- Sift through the various APIs until you find “Google Maps Android API v2”, then toggle that on
- Agree to the Terms of Service that appears when you try to toggle on Maps V2 access
- Click “API Access” in the left navigation bar
- Click the “Create new Android key...” button, towards the bottom of the page
- Fill in your SHA1 fingerprint, a semicolon, and the package name of your app in the text area in the dialog that appears

```
E6:C5:81:EB:8A:F4:35:B0:04:84:3E:6E:C3:88:BD:B2:66:52:E7:09;
com.commonware.android.mapsv2.basic
```

(note: normally all on one line, shown on two lines above so it fits on the page)

- Click the “Create” button to add the key

This will give you an “API key” that you will need for your application.

Note that this only authorizes one app’s package name. If you wish to have more than one app use Maps V2, you can click the “Edit allowed Android apps...” link in your key’s box, then add in other SHA1 fingerprint/package name combinations, one



## MAPPING WITH MAPS V2

per line, with the fingerprint and package name separated by semicolons. Or, if you prefer, create new keys for each application.

For apps that are in (or going to) production, you will need to supply both the debug and production SHA1 fingerprints with your package name. By doing this on the same key, you will use the same API key string for both debug and production builds, which simplifies things a fair bit over the separate API keys you would have used with the legacy Maps SDK add-on.

Also note that a single API key seems to only support a few fingerprint/package pairs. If you try adding a new pair, and the form ignores you, you will need to set up a separate API key for additional pairs.

### The Play Services Library

You also need to set up the Google Play Services library for use with your app.

First, you will need to download the “Google Play services” package in your SDK Manager (see highlighted line):

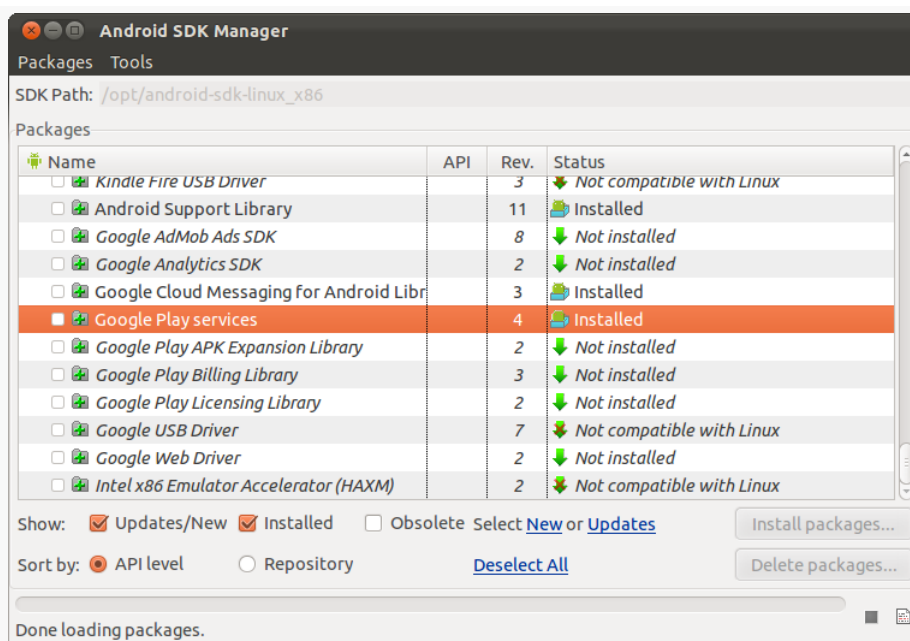


Figure 259: Android SDK Manager, Showing “Google Play services”

Next, if you are an Eclipse user, you will need to add the Play Services Android library project to your workspace. You can do this via the “Import Existing Android

Code into Workspace” wizard, pointing Eclipse to the `extras/google/google_play_services/libproject/google-play-services_lib/` directory inside of your Android SDK.

Finally, when you create a project that is to use Maps V2, you will need to add a reference to that library project, either via the Eclipse project properties dialog or via the `android update lib-project` command. This is the same process that you use for adding other Android library projects, such as ActionBarSherlock.

Note that the Play Services documentation requests that you add the following stanza to your `proguard-project.txt` file for use by your production builds:

```
-keep class * extends java.util.ListResourceBundle {
    protected Object[][] getContents();
}
```

It is unclear if this is strictly needed for Maps V2, as the Play Services library is used for other things beyond Maps V2.

## The Book Samples... And You!

If you wish to try to run the book samples outlined in this chapter, you will need to make a few fixes to them for your own environment:

- Replace the Maps V2 API key in the manifest with your own
- Replace the reference to the Play Services Android library project with your own
- Replace the reference to the ActionBarSherlock library project with your own
- Change the build target to an Android SDK that you have downloaded (or download the Android SDK used by the project)

## Setting Up a Basic Map

With that preparation work completed, now you can start working on projects that use the Maps V2 API. In this section, we will review the [MapsV2/Basic](#) sample project, which simply brings up a Maps V2 map on the world.

### The Project Setup

This project uses MapsV2, and so it has a reference to that library project. It also uses ActionBarSherlock, so the action bar pattern can work on pre-Android 3.0 devices, so it has a reference to that library project as well:

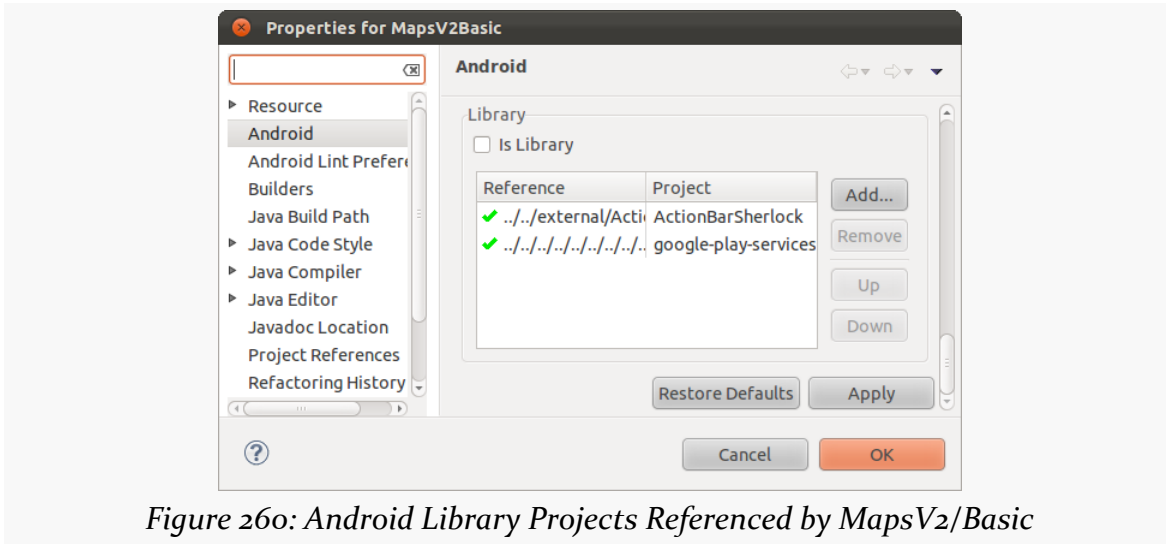


Figure 260: Android Library Projects Referenced by MapsV2/Basic

### The Manifest

Our manifest file is fairly traditional, though there are a number of elements in it that are required by MapsV2:

```
<?xml version="1.0" encoding="utf-8"?>
<manifest xmlns:android="http://schemas.android.com/apk/res/android"
  package="com.commonware.android.mapsv2.basic"
  android:versionCode="1"
  android:versionName="1.0">

  <uses-sdk
    android:minSdkVersion="8"
    android:targetSdkVersion="16"/>

  <permission
    android:name="com.commonware.android.mapsv2.basic.permission.MAPS_RECEIVE"
    android:protectionLevel="signature"/>

  <uses-permission
    android:name="com.commonware.android.mapsv2.basic.permission.MAPS_RECEIVE"/>
  <uses-permission android:name="android.permission.INTERNET"/>
  <uses-permission android:name="android.permission.WRITE_EXTERNAL_STORAGE"/>
  <uses-permission
```

## MAPPING WITH MAPS V2

---

```
android:name="com.google.android.providers.gsf.permission.READ_GSERVICES"/>

<uses-feature
  android:glEsVersion="0x00020000"
  android:required="true"/>

<application
  android:allowBackup="true"
  android:icon="@drawable/ic_launcher"
  android:label="@string/app_name"
  android:theme="@style/Theme.Sherlock.Light.DarkActionBar">
  <activity
    android:name="MainActivity"
    android:label="@string/app_name">
    <intent-filter>
      <action android:name="android.intent.action.MAIN"/>

      <category android:name="android.intent.category.LAUNCHER"/>
    </intent-filter>
  </activity>

  <meta-data
    android:name="com.google.android.maps.v2.API_KEY"
    android:value="AIzaSyC4iyT46cB00IdKGcy5EmAxK5uCOQX20y8"/>

  <activity android:name="LegalNoticesActivity">
  </activity>
</application>

</manifest>
```

Specifically:

- We need a `<permission>` element, defining a custom permission, with `android:protectionLevel="signature"` (so apps using and requiring the permission must have the same signing key), and with a name that is our app's package name with `.permission.MAPS_RECEIVE` appended
- We need a corresponding `<uses-permission>` element, naming that same permission
- We need the `INTERNET` and `WRITE_EXTERNAL_STORAGE` permissions, plus the `com.google.android.providers.gsf.permission.READ_GSERVICES` permission, all defined in `<uses-permission>` elements
- We may also need the `ACCESS_NETWORK_STATE` permission, which is not presently a documented requirement, but [crashes in production suggest is actually necessary](#)
- We need a `<uses-feature>` element, declaring that OpenGL ES 2.0 is required, as that 3D API is used by MapsV2

- We need a `<meta-data>` element, with a name of `com.google.android.maps.v2.API_KEY`, whose value is the API key we got from the Google APIs Console for use with this particular package name

Beyond those items, everything else in this project is based on what the app needs, more so than what MapsV2 needs.

### The Play Services Detection

In the fullness of time, all devices that are capable of using Maps V2 will already have the on-device portion of this logic, known as the “Google Play services” app.

However, it is entirely possible, in the short term, that you will encounter devices that are capable of using Maps V2 (e.g., they have OpenGL ES 2.0 or higher), but do not have the “Google Play services” app from the Play Store, and therefore you cannot actually use Maps V2 in your app.

This is a departure from the Maps V1 approach, where either the device shipped with maps capability, or it did not, and nothing (legally) could be done to change that state.

To determine whether or not the Maps V2 API is available to you, the best option is to call the `isGooglePlayServicesAvailable()` static method on the `GooglePlayServicesUtil` utility class supplied by the Play Services library. This will return an `int`, with a value of `ConnectionResult.SUCCESS` if Maps V2 can be used right away.

Actually assisting the user to get Maps V2 set up all the way is conceivable but is also bug-riddled and annoying. The `MapsV2/Basic` sample app has an `AbstractMapActivity` base class that is designed to hide most of this annoyance from you. If you wish to know the details of how this works, we will cover it [later in this chapter](#). The fact that this is bug-riddled also has impacts on whether or not you should be using Maps V2 at all for your app, a point which we will examine [in an upcoming section](#).

### The Fragment and Activity

Our main activity — `MainActivity` — extends from the aforementioned `AbstractMapActivity` and simply overrides `onCreate()`, as most activities do:

## MAPPING WITH MAPS V2

---

```
package com.commonware.android.mapsv2.basic;

import android.os.Bundle;

public class MainActivity extends AbstractMapActivity {
    @Override
    protected void onCreate(Bundle savedInstanceState) {
        super.onCreate(savedInstanceState);

        if (readyToGo()) {
            setContentView(R.layout.activity_main);
        }
    }
}
```

We call `setContentView()` to load up the `activity_main` layout resource:

```
<fragment xmlns:android="http://schemas.android.com/apk/res/android"
    android:id="@+id/map"
    android:layout_width="match_parent"
    android:layout_height="match_parent"
    class="com.google.android.gms.maps.SupportMapFragment" />
```

That resource, in turn, has a `<fragment>` element pointing to a `com.google.android.gms.maps.SupportMapFragment` class supplied by the Play Services library. This is a fragment that knows how to display a Maps V2 map. In particular, it is a fragment designed for use with the Android Support project's backport of fragments. There is a corresponding `com.google.android.gms.maps.MapFragment` class for use with the native API Level 11 version of fragments.

You will notice, though, that we only call `setContentView()` if a `readyToGo()` method returns true. The `readyToGo()` method is supplied by the `AbstractMapActivity` class and returns true if we are safe to go ahead and use Maps V2, false otherwise. In the false case, `AbstractMapActivity` will be taking care of trying to get Maps V2 going, and we need do nothing further.

Note that `SupportMapFragment` is designed to work with the Android Support package, but *not* with `ActionBarSherlock`. However, a `SherlockFragmentActivity` (like `AbstractMapActivity`) can load a `SupportMapFragment`. So long as you are only *using* `SupportMapFragment`, it should co-exist with `ActionBarSherlock` without difficulty. If, however, your objective would be to *extend* `SupportMapFragment` and add logic that might depend upon `ActionBarSherlock` (e.g., contribute items to the action bar), that will not work. Instead, you will need to use the Maps V2 version of the `MapView` widget directly (as will be covered [later in this chapter](#)) or hope that somebody else comes up with a `SherlockMapFragment` that works with Maps V2.

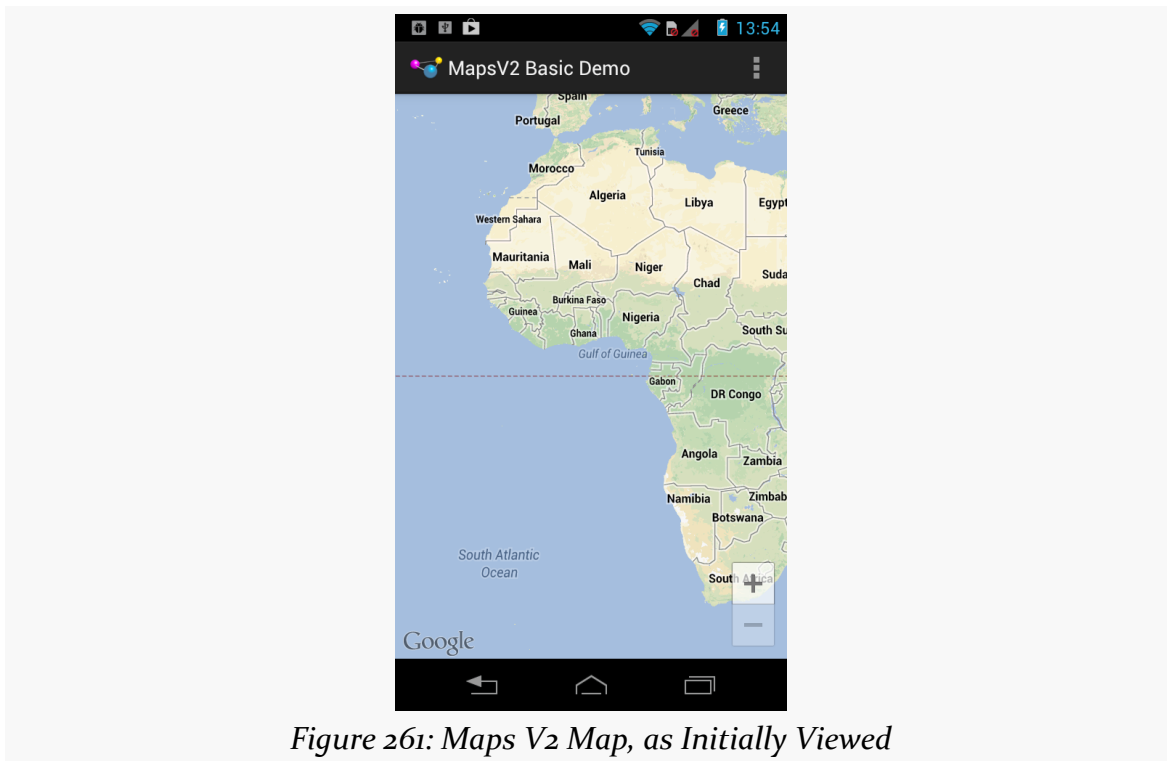
### The License

According to the terms of use for Maps V2, you must show Maps V2 license information in your app's UI, in some likely spot. Apps that show their own license terms, or have an "about" activity (or dialog) could display them there. Otherwise, you will need to have a dedicated spot for the Maps V2 license.

To obtain the license text, you can call `getOpenSourceSoftwareLicenseInfo()` on the `GooglePlayServicesUtil` utility class. This text can then be popped into a `TextView` somewhere in your app. `AbstractMapActivity` adds an action bar overflow item to display the license, which in turn invokes a `LegalNoticesActivity`, which simply displays the license text in a `TextView`. We will examine this in more detail [later in this chapter](#).

### The Result

When you run the app, assuming that Maps V2 is ready for use, you will get a basic map showing the west coast of Africa:

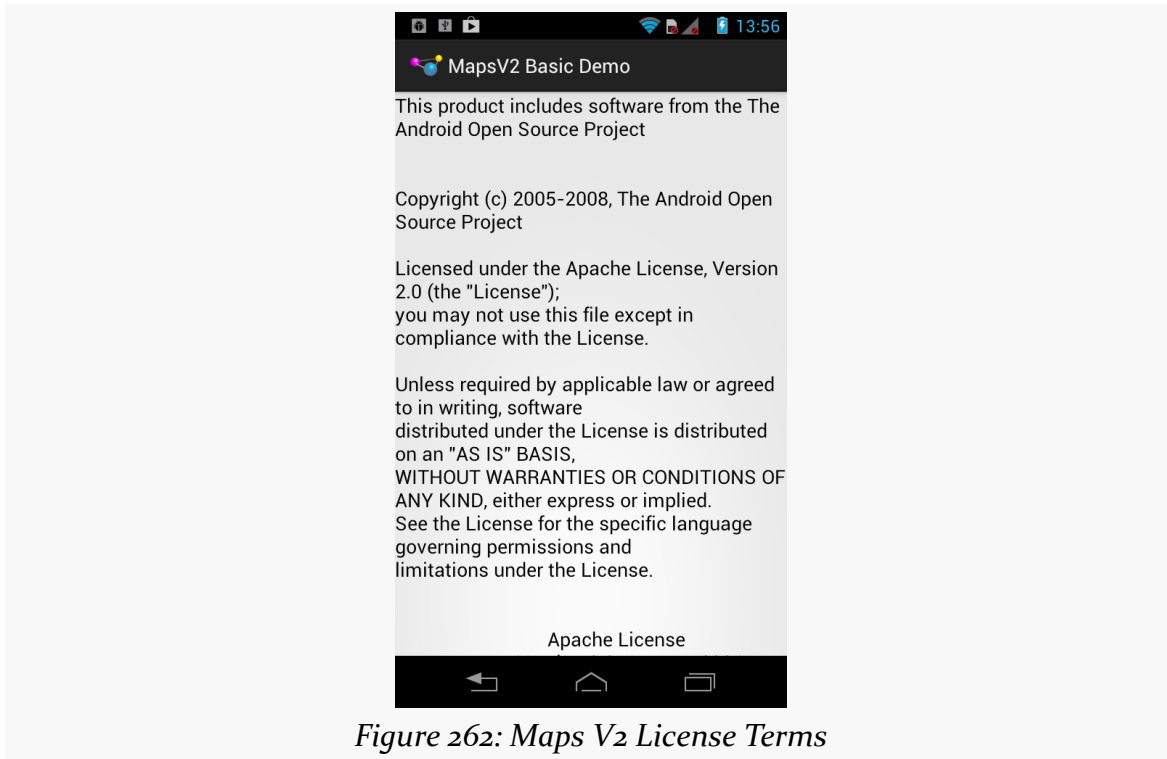


---

## MAPPING WITH MAPS V2

---

If you choose the “Legal Notices” action bar item, the view shifts to show a bunch of license terms:



If your Maps V2 API key is incorrect, or you do not have this app’s package name set up for that key in the Google APIs Console, you will get an “Authorization failure” error message in LogCat, and you will get a blank map, akin to the behavior seen in Maps V1 when you had an invalid `android:apiKey` attribute on the `MapView`.

## Playing with the Map

Showing a map of the west coast of Africa is nice, and it is entirely possible that is precisely what you wanted to show the user. If, on the other hand, you wanted to show the user something else — another location, a closer look, etc. — you will need to further configure your map, via a `GoogleMap` object.

To see how this is done, take a look at the [MapsV2/NooYawk](#) sample application. This is a clone of `MapsV2/Basic` that adds in logic to center and zoom the map over a portion of New York City, plus allow the user to toggle which set of map tiles to see.



## MAPPING WITH MAPS V2

---

The `onCreate()` method of the revised `MapActivity` is now a bit more involved:

```
@Override
protected void onCreate(Bundle savedInstanceState) {
    super.onCreate(savedInstanceState);

    if (readyToGo()) {
        setContentView(R.layout.activity_main);

        SupportMapFragment mapFrag=
(SupportMapFragment)getSupportFragmentManager().findFragmentById(R.id.map);

        initListNav();

        map=mapFrag.getMap();

        if (savedInstanceState == null) {
            CameraUpdate center=
                CameraUpdateFactory.newLatLng(new LatLng(40.76793169992044,
                                                            -73.98180484771729));
            CameraUpdate zoom=CameraUpdateFactory.zoomTo(15);

            map.moveCamera(center);
            map.animateCamera(zoom);
        }
    }
}
```

After calling `setContentView()`, we can retrieve our `SupportMapFragment` via `findFragmentById()`, no different than any other fragment. In this case, we do so simply to call `getMap()` on it, which returns our `GoogleMap` object. Most of our work in configuring the map will be accomplished by calling methods on this `GoogleMap` object.

To change where the map is centered, we can create a `CameraUpdate` object from the `CameraUpdateFactory` (“camera” in this case referring to the position of the user’s virtual eyes with respect to the surface of the Earth). The `newLatLng()` factory method on `CameraUpdateFactory` will give us a `CameraUpdate` object that can re-center the map over a supplied latitude and longitude. Those coordinates are encapsulated in a `LatLng` object and are maintained as decimal degrees as Java `float` or `double` values (as opposed to the Maps V1 `GeoPoint`, which used integer microdegrees).

To change the zoom level of the map, we need another `CameraUpdate` object, this time from the `zoomTo()` factory method on `CameraUpdateFactory`. As with Maps V1,

## MAPPING WITH MAPS V2

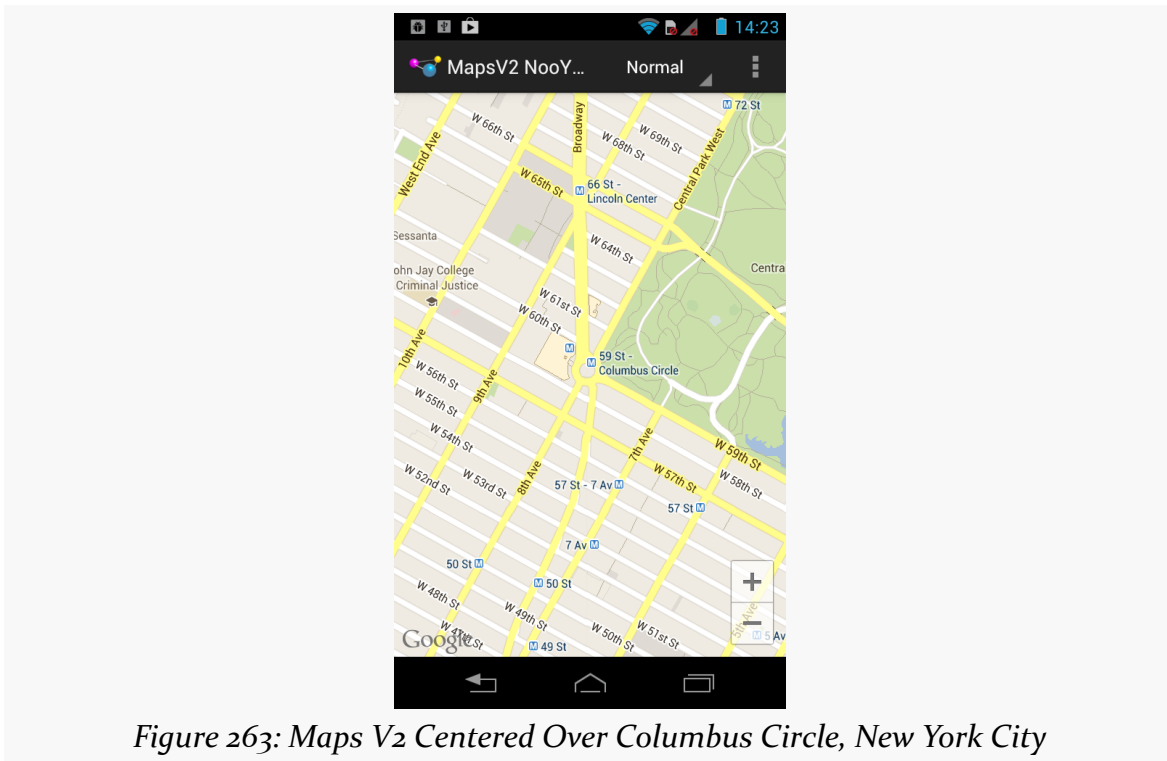
---

the zoom levels start at 1 and zoom in by powers of two. As you will see, a value of 15 gives you a nice block-level view of a city like New York City.

To actually apply these changes to the map, we have two methods on `GoogleMap`:

1. `moveCamera()` will perform a “smash cut” and immediately change the map based upon the supplied `CameraUpdate`
2. `animateCamera()` will smoothly animate the map from its original state to the new state supplied by the `CameraUpdate`

In our case, we immediately shift to the proper position, but then zoom in from the default zoom level to 15, giving us a map centered over Columbus Circle, in the southwest corner of Central Park in Manhattan:



*Figure 263: Maps V2 Centered Over Columbus Circle, New York City*

We do all that work inside a check of the `savedInstanceState` parameter, as we only wish to initialize the map fragment when it is first created. Otherwise, on a configuration change, we re-center and re-zoom the map, wiping out any changes the user may have made. `MapFragment` (and `SupportMapFragment`) automatically retain their camera settings when a configuration change occurs, saving us that trouble.

## MAPPING WITH MAPS V2

---

You will also notice that our action bar has list navigation, defaulted to “Normal”. That was set up by the `initListNav()` method invoked from `onCreate()`:

```
private void initListNav() {
    ArrayList<String> items=new ArrayList<String>();
    ArrayAdapter<String> nav=null;
    ActionBar bar=getSupportActionBar();

    for (int type : MAP_TYPE_NAMES) {
        items.add(getString(type));
    }

    if (Build.VERSION.SDK_INT >= Build.VERSION_CODES.ICE_CREAM_SANDWICH) {
        nav=
            new ArrayAdapter<String>(
                bar.getThemedContext(),
                android.R.layout.simple_spinner_item,
                items);
    }
    else {
        nav=
            new ArrayAdapter<String>(
                this,
                android.R.layout.simple_spinner_item,
                items);
    }

    nav.setDropDownViewResource(android.R.layout.simple_spinner_dropdown_item);
    bar.setNavigationMode(ActionBar.NAVIGATION_MODE_LIST);
    bar.setListNavigationCallbacks(nav, this);
}
```

Here, we simply set up a hard-coded set of navigation choices, from the `MAP_TYPE_NAMES` static array of string resource IDs:

```
private static final int[] MAP_TYPE_NAMES= { R.string.normal,
    R.string.hybrid, R.string.satellite, R.string.terrain };
```

We also set up the activity itself as being the listener for navigation events, by passing it into `setListNavigationCallbacks()` and implementing the `OnNavigationItemSelectedListener` interface. This requires an `onNavigationItemSelected()` method, called when the user changes the value in the drop-down list:

```
@Override
public boolean onNavigationItemSelected(int itemPosition, long itemId) {
    map.setMapType(MAP_TYPER[itemPosition]);

    return(true);
}
```

## MAPPING WITH MAPS V2

---

Here, based on the position selected in the list navigation, we call `setMapType()` on the `GoogleMap` with a corresponding map type:

```
private static final int[] MAP_TYPES= { GoogleMap.MAP_TYPE_NORMAL,  
    GoogleMap.MAP_TYPE_HYBRID, GoogleMap.MAP_TYPE_SATELLITE,  
    GoogleMap.MAP_TYPE_TERRAIN };
```

The `setMapType()` method switches the tile set used by the map. For example, we can switch to “hybrid” mode, which is a satellite view with labels for points of interest:

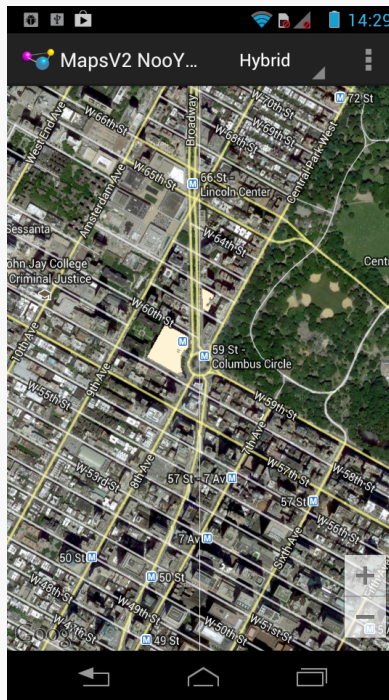


Figure 264: Maps V2 with Hybrid Map Tiles

There is also a pure satellite mode (sans labels) and a “terrain” mode for a roughly topographical look at the landscape.

We also hold onto the navigation item across configuration changes via `onSaveInstanceState()` and `onRestoreInstanceState()`:

```
@Override  
public void onSaveInstanceState(Bundle state) {  
    super.onSaveInstanceState(state);  
  
    state.putInt(STATE_NAV,
```

```
        getSupportActionBar().getSelectedNavigationIndex());
    }

    @Override
    public void onRestoreInstanceState(Bundle state) {
        super.onRestoreInstanceState(state);

        getSupportActionBar().setSelectedItem(state.getInt(STATE_NAV));
    }
}
```

## Placing Simple Markers

In Maps V1, if we wanted to annotate a map, we used an `Overlay`. For markers — push-pins and the like — typically we would use an `ItemizedOverlay`, which handled a lot of the work of rendering these markers and responding to taps upon markers. However, `ItemizedOverlay` had its issues, particularly with regards to performance with large numbers of markers.

With Maps V2, the entire `Overlay` system is eliminated. Instead, you simply hand markers to the `GoogleMap` for display, as is illustrated in the [MapsV2/Markers](#) sample application. This is a clone of `MapsV2/NooYawk`, with four markers for four landmarks within Manhattan.

Our `onCreate()` method on `MainActivity` now has four additional statements — calls to a private `addMarker()` method to define the four landmarks:

```
addMarker(map, 40.748963847316034, -73.96807193756104,
          R.string.un, R.string.united_nations);
addMarker(map, 40.76866299974387, -73.98268461227417,
          R.string.lincoln_center,
          R.string.lincoln_center_snippet);
addMarker(map, 40.765136435316755, -73.97989511489868,
          R.string.carnegie_hall, R.string.practice_x3);
addMarker(map, 40.70686417491799, -74.01572942733765,
```

The `addMarker()` method on our `MainActivity` adds markers by creating a `MarkerOptions` object and passing it to the `addMarker()` on `GoogleMap`. `MarkerOptions` offers a so-called “fluent” interface, with a series of methods to affect one aspect of the `MarkerOptions`, each of which returns the `MarkerOptions` object itself. That way, configuring a `MarkerOptions` is a chained series of method calls:

```
private void addMarker(GoogleMap map, double lat, double lon,
                      int title, int snippet) {
    map.addMarker(new MarkerOptions().position(new LatLng(lat, lon))
                 .title(getString(title))
```

## MAPPING WITH MAPS V2

---

```
        .snippet(getString(snippet)));  
    }
```

Here, we:

- Set the `position()` of the marker, in the form of another `LatLng` object
- Set the `title()` and `snippet()` of the marker to be a pair of strings loaded from string resources

We will see other methods available on `MarkerOptions` in upcoming sections of this chapter.

`addMarker()` on `GoogleMap` returns an actual `Marker` object, which we could hold onto to change certain aspects of it later on (e.g., its title). In the case of this sample, we ignore this.

If you look at the full implementation of `onCreate()`, you will see that our `addMarker()` calls are *outside* the `savedInstanceState` check that we added in `MapsV2/NooYawk`:

```
@Override  
protected void onCreate(Bundle savedInstanceState) {  
    super.onCreate(savedInstanceState);  
  
    if (readyToGo()) {  
        setContentView(R.layout.activity_main);  
  
        SupportMapFragment mapFrag=  
(SupportMapFragment)getSupportFragmentManager().findFragmentById(R.id.map);  
  
        initListNav();  
  
        map=mapFrag.getMap();  
  
        if (savedInstanceState == null) {  
            CameraUpdate center=  
                CameraUpdateFactory.newLatLng(new LatLng(40.76793169992044,  
                                                            -73.98180484771729));  
            CameraUpdate zoom=CameraUpdateFactory.zoomTo(15);  
  
            map.moveCamera(center);  
            map.animateCamera(zoom);  
        }  
  
        addMarker(map, 40.748963847316034, -73.96807193756104,  
                R.string.un, R.string.united_nations);  
        addMarker(map, 40.76866299974387, -73.98268461227417,  
                R.string.lincoln_center,  
                R.string.lincoln_center);  
    }  
}
```

## MAPPING WITH MAPS V2

```
        R.string.lincoln_center_snippet);  
addMarker(map, 40.765136435316755, -73.97989511489868,  
        R.string.carnegie_hall, R.string.practice_x3);  
addMarker(map, 40.70686417491799, -74.01572942733765,  
        R.string.downtown_club, R.string.heisman_trophy);  
    }  
}
```

That is because while a MapFragment retains its camera information (center, zoom, etc.), it does *not* retain its markers on a configuration change. Hence, we need to re-establish the markers in all calls to onCreate(), not just the very first one.

With no other changes, we get a version of the map that shows markers at our designated locations:

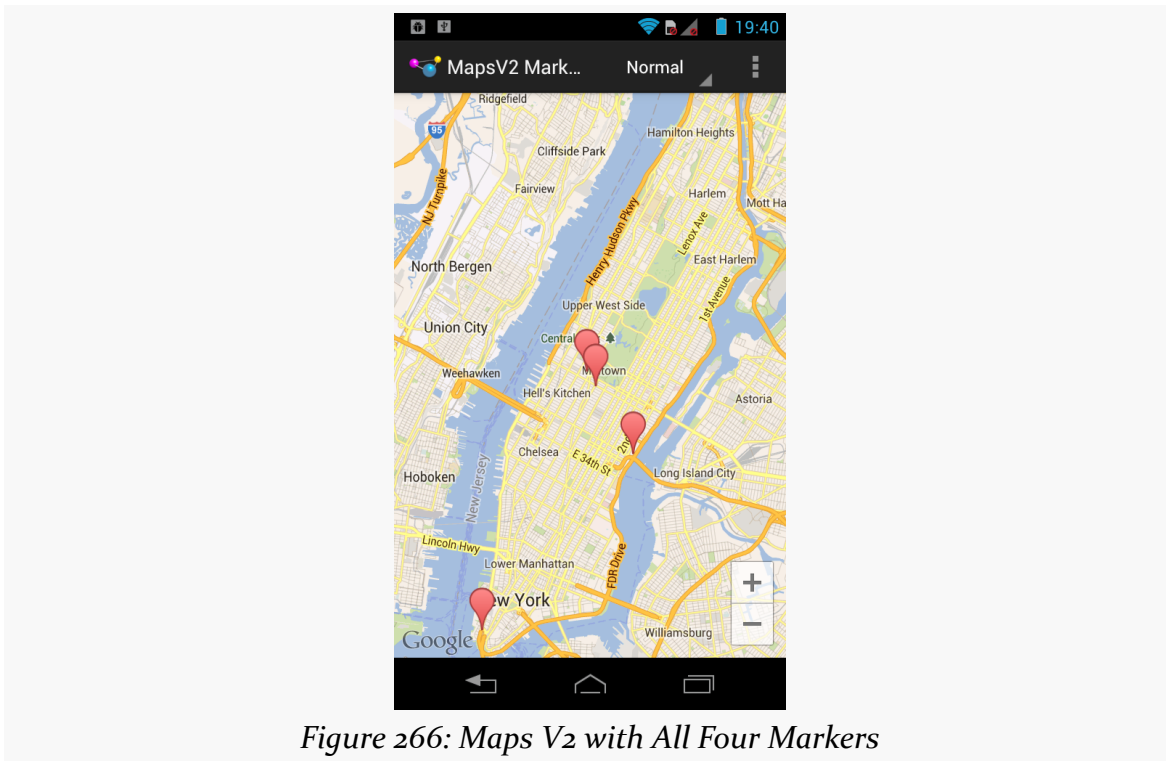


Figure 265: Maps V2 with Two Markers

Initially, we only see two markers, as the other two are outside the current center position and zoom level of the map. If the user changes the center or zoom, markers will come and go as needed:

## MAPPING WITH MAPS V2

---



*Figure 266: Maps V2 with All Four Markers*

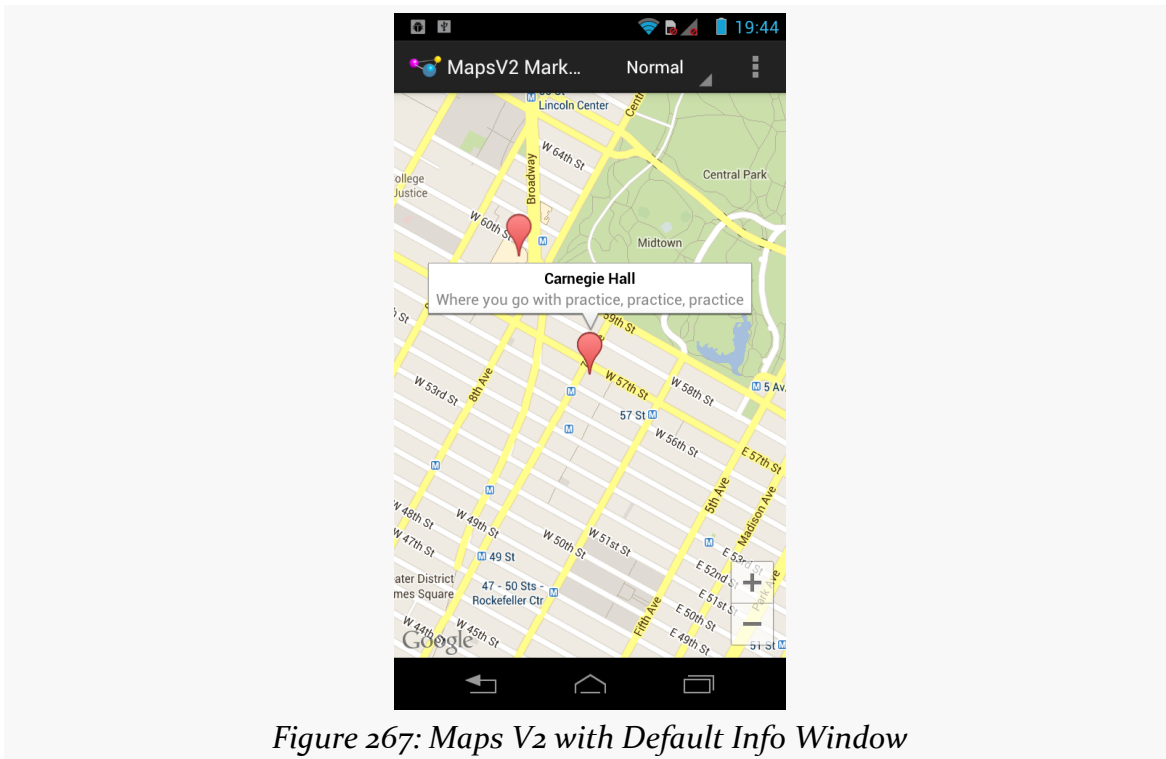
We do not need to worry about managing the markers ourselves, so long as the GoogleMap performance is adequate. It is likely that dumping 10,000 markers into a GoogleMap will still result in sluggish responses, though, so you may need to add and remove markers yourself based upon what portion of the world the user happens to be examining in the map at the moment.

## Sprucing Up Your “Info Windows”

If the user taps on one of the markers from the preceding sample, Android will automatically display a popup, known as an “info window”:



## MAPPING WITH MAPS V2



You can tailor that “info window” if desired, either replacing just the interior portion (leaving the bounding border with its caret intact) or replacing the entire window. However, in the interests of memory conservation, you do not hand new View widgets to the MarkerOptions object. Instead, you can provide an adapter that will be called when info windows (or their contents) are required.

To see how this works, we can examine the [MapsV2/Popups](#) sample application. This is a clone of MapsV2/Markers, where we are using our own layout file for the contents of the info windows, from the popup.xml layout resource:

```
<?xml version="1.0" encoding="utf-8"?>
<LinearLayout xmlns:android="http://schemas.android.com/apk/res/android"
    android:layout_width="fill_parent"
    android:layout_height="wrap_content"
    android:orientation="horizontal">

    <ImageView
        android:id="@+id/icon"
        android:layout_width="wrap_content"
        android:layout_height="wrap_content"
        android:layout_gravity="center_vertical"
        android:padding="2dip"
        android:src="@drawable/ic_launcher"
```

## MAPPING WITH MAPS V2

---

```
        android:contentDescription="@string/icon"/>

<LinearLayout
    android:layout_width="fill_parent"
    android:layout_height="wrap_content"
    android:orientation="vertical">

    <TextView
        android:id="@+id/title"
        android:layout_width="wrap_content"
        android:layout_height="wrap_content"
        android:textSize="25sp"
        android:textStyle="bold"/>

    <TextView
        android:id="@+id/snippet"
        android:layout_width="wrap_content"
        android:layout_height="wrap_content"
        android:textSize="15sp"/>
</LinearLayout>
</LinearLayout>
```

Here, we will show the title and snippet in our own chosen font size and weight, plus show the launcher icon on the left.

To use this layout, we must create an `InfoWindowAdapter` implementation — in the case of this sample project, that is found in the `PopupAdapter` class:

```
package com.commonware.android.mapsv2.popups;

import android.view.LayoutInflater;
import android.view.View;
import android.widget.TextView;
import com.google.android.gms.maps.GoogleMap.InfoWindowAdapter;
import com.google.android.gms.maps.model.Marker;

class PopupAdapter implements InfoWindowAdapter {
    LayoutInflater inflater=null;

    PopupAdapter(LayoutInflater inflater) {
        this.inflater=inflater;
    }

    @Override
    public View getInfoWindow(Marker marker) {
        return(null);
    }

    @Override
    public View getInfoContents(Marker marker) {
        View popup=inflater.inflate(R.layout.popup, null);
    }
}
```

```
TextView tv=(TextView)popup.findViewById(R.id.title);

tv.setText(marker.getTitle());
tv=(TextView)popup.findViewById(R.id.snippet);
tv.setText(marker.getSnippet());

return(popup);
}
}
```

When an info window is to be displayed, Android will first call `getInfoWindow()` on our `InfoWindowAdapter`, passing in the `Marker` whose info window is needed. If we return a `View` here, that will be used for the entire info window. If, instead, we return `null`, Android will call `getInfoContents()`, passing in the same `Marker` object. If we return a `View` here, Android will use that as the “body” of the info window, with Android supplying the border. If we return `null`, the default info window is displayed. This way, we can conditionally do any of the three possibilities (replace the window, replace the contents, or accept the default).

In our case, `getInfoContents()` will inflate the `popup.xml` layout and populate the two `TextView` widgets with the title and snippet from the `Marker`.

Then, we just need to tell the `GoogleMap` to use our `InfoWindowAdapter`, via a call to `setInfoWindowAdapter()`, such as this statement from `onCreate()` of our new edition of `MainActivity`:

```
map.setInfoWindowAdapter(new PopupAdapter(getLayoutInflater()));
```

Now, when the user taps on a marker, they will get our customized info window:

## MAPPING WITH MAPS V2

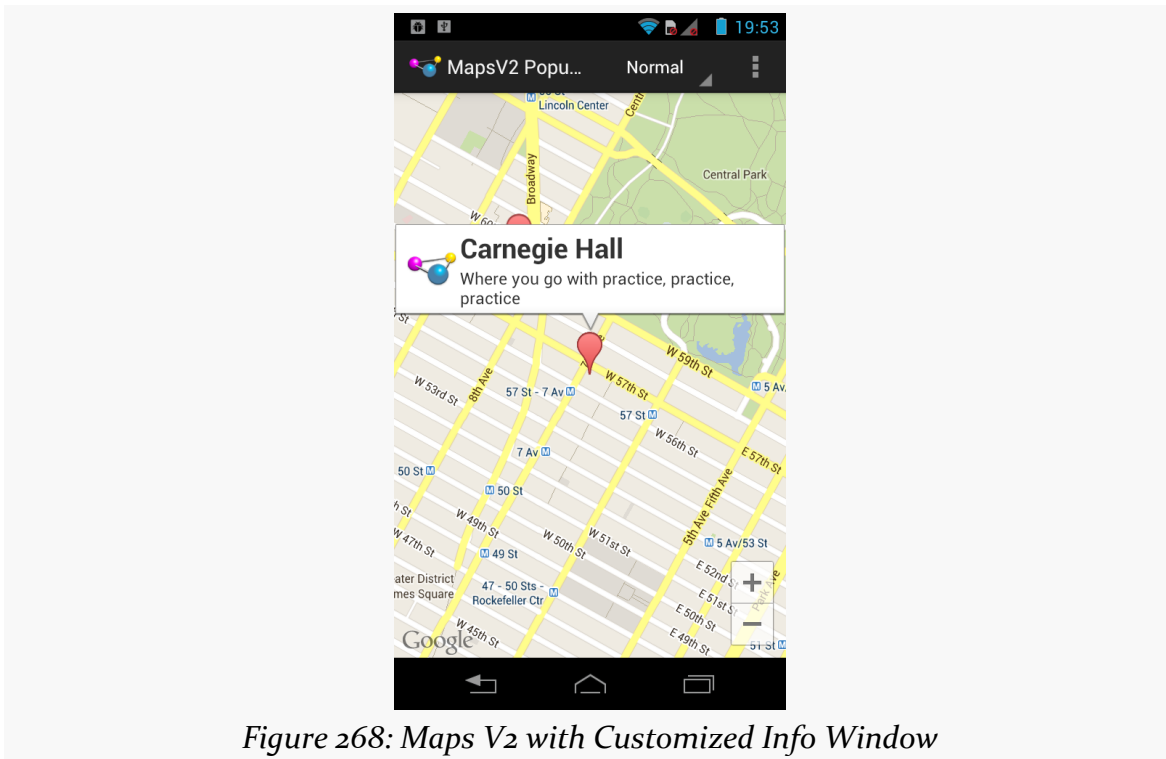


Figure 268: Maps V2 with Customized Info Window

We can also call `setOnInfoWindowClickListener()` on our `GoogleMap`, passing in an implementation of the `OnInfoWindowClickListener` interface, to find out when the user taps on the info window. In the case of `MainActivity`, we set up the activity itself to implement that interface and be the listener:

```
map.setOnInfoWindowClickListener(this);
```

This requires us to implement an `onInfoWindowClick()` method, where we are passed the `Marker` representing the tapped-upon info window:

```
@Override
public void onInfoWindowClick(Marker marker) {
    Toast.makeText(this, marker.getTitle(), Toast.LENGTH_LONG).show();
}
```

Here, we just display a `Toast` with the title of the `Marker` when the user taps an info window:

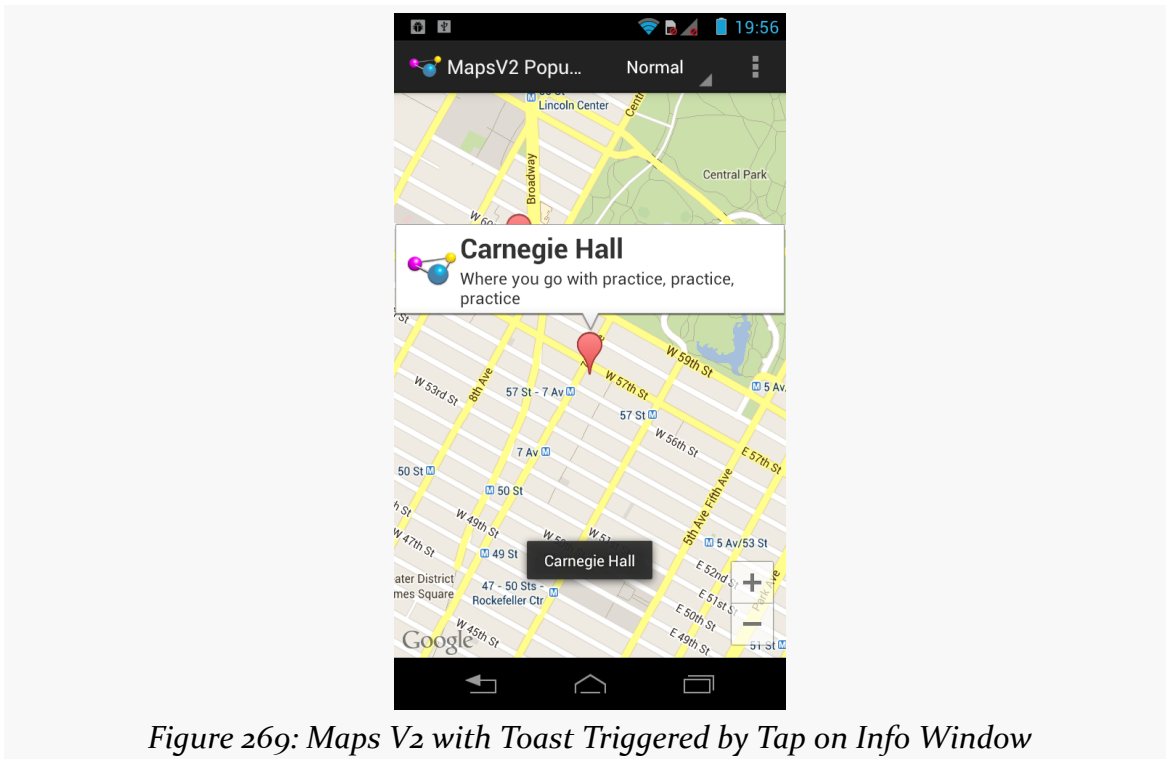


Figure 269: Maps V2 with Toast Triggered by Tap on Info Window

Note that, according to the documentation, you can only find out about taps on the entire info window. Indeed, if you try setting up click listeners on the widgets in your custom layout, you will find that they are not called. Presumably, this is to steer developers in the direction of making larger tap targets, rather than expecting users to tap tiny elements within an info window. On the other hand, if your design calls for a large info window containing several navigation options, you will need to either re-think your design or avoid the info window system. We will see how to find out about taps on markers more directly [later in this chapter](#).

## Setting the Marker Icon

Unlike Maps V1, Maps V2 includes a stock marker icon that looks a lot like the standard Google Maps marker. You have three major choices for what to use for your own markers:

1. Stick with the stock icon, which is the default behavior
2. Change the stock icon to a different hue
3. Replace the stock icon with your own from an asset, resource, file, or in-memory Bitmap

## MAPPING WITH MAPS V2

---

To indicate that you want a different icon than the stock one, use the `icon()` method on the `MarkerOptions` fluent interface. This takes a `BitmapDescriptor`, which you get from one of a series of static methods on the `BitmapDescriptorFactory` class.

For example, you might have a revised version of the `addMarker()` method of `MainActivity` that took a hue — a value from 0 to 360 representing different colors along a color wheel. 0 represents red, 120 represents green, and 240 represents blue, with different shades in between. There is a series of `HUE_` constants defined on `BitmapDescriptorFactory`, plus a `defaultMarker()` method that takes a hue as a parameter and returns a `BitmapDescriptor` that will use the stock icon, colored to the specified hue:

```
private void addMarker(GoogleMap map, double lat, double lon,
                      int title, int snippet, int hue) {
    map.addMarker(new MarkerOptions().position(new LatLng(lat, lon))
                 .title(getString(title))
                 .snippet(getString(snippet))
                 .icon(BitmapDescriptorFactory.defaultMarker(hue)));
}
```

This could then be used to give you different colors per marker, or by category of marker, etc.:

## MAPPING WITH MAPS V2

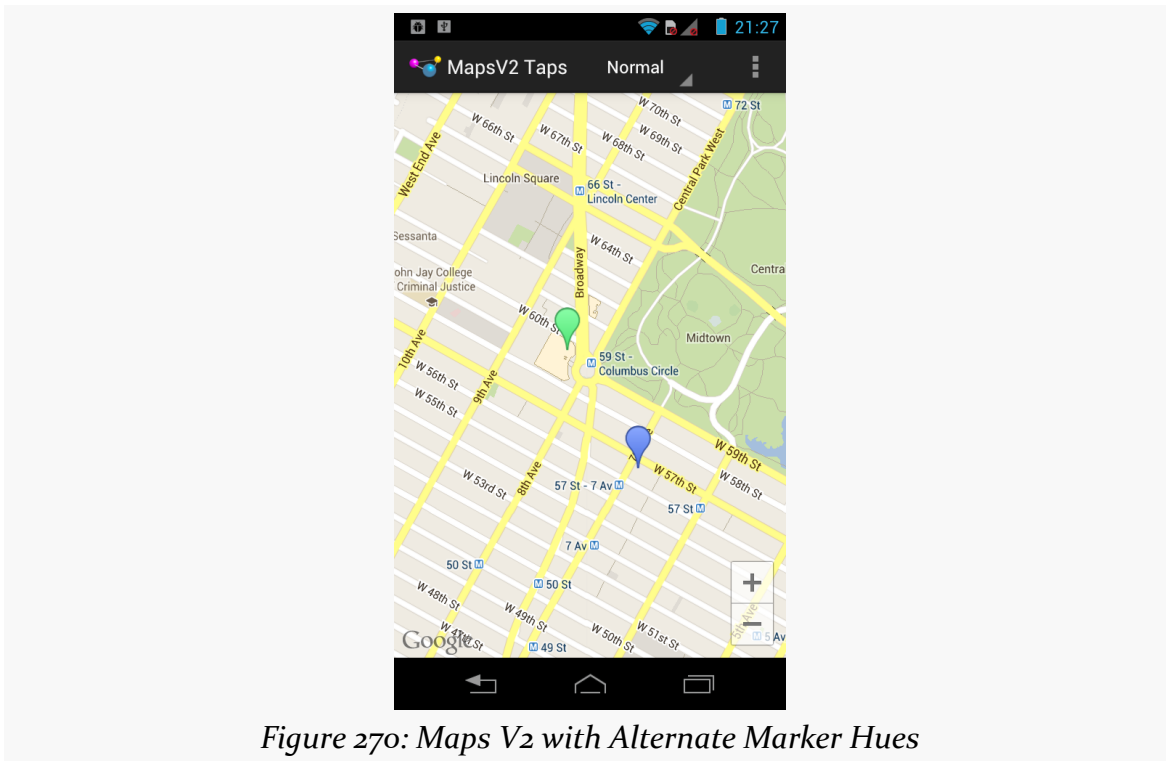


Figure 270: Maps V2 with Alternate Marker Hues

However, there are two noteworthy limitations:

1. For some reason, you cannot change the icon of the marker at runtime. Your only option would be to remove and replace the marker.
2. You cannot draw the marker directly yourself, the way you might have with Maps V1. What you *can* do is draw to a Bitmap-backed Canvas object, then use the resulting Bitmap with `BitmapFactoryDescriptor` and its `fromBitmap()` factory method.

## Responding to Taps

Perhaps we would like to find out when a user taps on one of our markers, instead of displaying an info window. Maybe we want to have some other UI response to that tap in our app.

To do that, simply create an implementation of the `OnMarkerClickListener` interface and attach it to the `GoogleMap` via `setOnMarkerClickListener()`. You will then be called with `onMarkerClick()` when the user taps on a marker, and you are passed the `Marker` object in question. If you return `true`, you are indicating that you

## MAPPING WITH MAPS V2

---

are handling the event; returning false means that default handling (the info window) should be done.

You can see this, plus the multi-colored markers, in the [MapsV2/Taps](#) sample application. This takes MapsV2/Popups and adds a Toast when the user taps a marker, in addition to displaying the info window:

```
@Override
public boolean onMarkerClick(Marker marker) {
    Toast.makeText(this, marker.getTitle(), Toast.LENGTH_LONG).show();

    return(false);
}
```

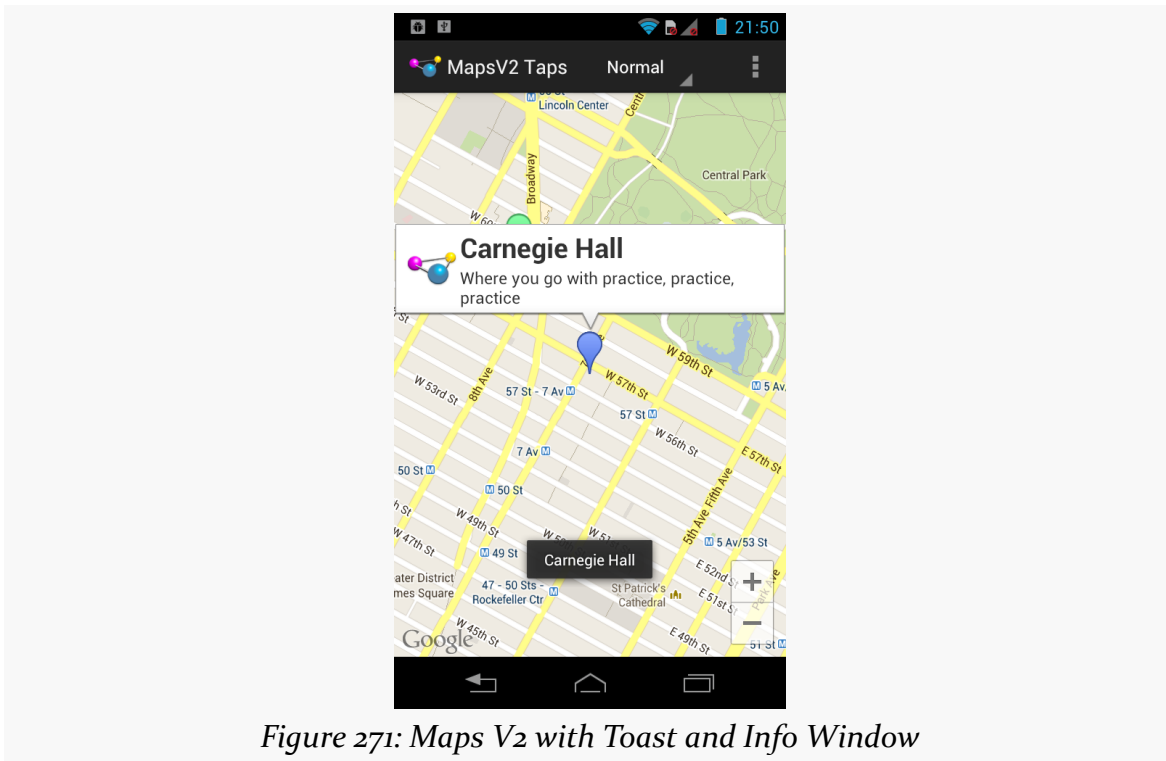


Figure 271: Maps V2 with Toast and Info Window

Our call to `setOnMarkerClickListener()` is up in the `onCreate()` method of `MainActivity`:

```
map.setOnMarkerClickListener(this);
```



## Dragging Markers

In Maps V1, if you wanted to drag-and-drop map markers, you had to handle all of that yourself, using low-level touch events.

Conversely, Maps V2 handles marker drag-and-drop for you.

By default, markers are not draggable. But, if you call `draggable(true)` on your `MarkerOptions` when creating the marker — or call `setDraggable(true)` on the `Marker` later on — Android will automatically support drag-and-drop. The user can tap-and-hold on the marker to enable drag mode, then slide the marker around the map.

Note that at the present time, this functionality is a little odd. When you tap-and-hold the marker, with drag mode enabled, the marker initially jumps away from its original position. The user can reposition the marker to any desired location, and the marker will seem to “drop” where the user requests. Why the marker makes the sudden shift at the outset, using the default marker settings, is unclear.

Of course, your code may need to know about drag-and-drop events, such as to update your own data model to reflect the newly-chosen location. You can register an `OnMarkerDragListener` that will be notified of the start of the drag, where the marker slides during the drag, and where the marker is dropped at the end of the drag.

You can see all of this in the [MapsV2/Drag](#) sample application, which is a clone of `MapsV2/Popup` with drag-and-drop enabled.

To enable drag-and-drop, we just chain `draggable(true)` onto the series of calls on our `MarkerOptions` when creating the markers:

```
private void addMarker(GoogleMap map, double lat, double lon,
    int title, int snippet) {
    map.addMarker(new MarkerOptions().position(new LatLng(lat, lon))
        .title(getString(title))
        .snippet(getString(snippet))
        .draggable(true));
}
```

We also register `MainActivity` as being the drag listener, up in `onCreate()`:

```
map.setOnMarkerDragListener(this);
```

## MAPPING WITH MAPS V2

---

That requires MainActivity to implement OnMarkerDragListener, which in turn requires three methods to be defined: onMarkerDragStart(), onMarkerDrag(), and onMarkerDragEnd():

```
@Override
public void onMarkerDragStart(Marker marker) {
    LatLng position=marker.getPosition();

    Log.d(getClass().getSimpleName(), String.format("Drag from %f:%f",
                                                    position.latitude,
                                                    position.longitude));
}

@Override
public void onMarkerDrag(Marker marker) {
    LatLng position=marker.getPosition();

    Log.d(getClass().getSimpleName(),
          String.format("Dragging to %f:%f", position.latitude,
                        position.longitude));
}

@Override
public void onMarkerDragEnd(Marker marker) {
    LatLng position=marker.getPosition();

    Log.d(getClass().getSimpleName(), String.format("Dragged to %f:%f",
                                                    position.latitude,
                                                    position.longitude));
}
```

Here, we just dump the information about the new marker position in LogCat.

So, if you run this app and drag-and-drop a marker, you will see output in LogCat akin to:

```
12-19 13:10:36.442: D/MainActivity(22510): Drag from 40.770876:-73.982499
12-19 13:10:36.892: D/MainActivity(22510): Dragging to 40.770876:-73.981593
12-19 13:10:36.912: D/MainActivity(22510): Dragging to 40.770795:-73.981352
12-19 13:10:36.932: D/MainActivity(22510): Dragging to 40.770754:-73.981141
.
.
.
12-19 13:10:38.292: D/MainActivity(22510): Dragging to 40.769596:-73.983615
12-19 13:10:38.372: D/MainActivity(22510): Dragged to 40.769596:-73.983615
```

The actual list of events was much longer, as onMarkerDrag() is called a *lot*, so the ... in the LogCat entries above reflect another 50 or so lines for a drag-and-drop that took a couple of seconds.

Also, up in `onCreate()`, we retain our `SupportMapFragment` across configuration changes via `setRetainInstance(true)`:

```
mapFrag.setRetainInstance(true);
```

While `MapFragment` and `SupportMapFragment` will hold onto their markers across a configuration change by default, they do not hold onto changed marker positions via drag-and-drop. Retaining the fragment instance causes the fragment to keep our markers in their moved positions, rather than resetting them to their original positions.

## The “Final” Limitations

With Maps V1 and `ItemizedOverlay`, `OverlayItem` was a regular Java class. You could extend this class, to support additional data or behaviors that were unique to your app.

Of course, an even more flexible approach would have been for `OverlayItem` to be an interface, with a stock `SimpleOverlayItem` concrete implementation. That way, you could implement `OverlayItem` on some Java class resident elsewhere in your app’s class hierarchy (e.g., inheriting from some class needed for a persistence framework).

Rather than taking a step forward, Maps V2 took a step backward instead.

In Maps V2, not only do you not create `Marker` objects directly yourself, but `Marker` is marked as `final` and cannot be extended.

This, coupled with the fact that there is no unique identifier that we control on `Marker`, means that associating `Marker` objects with the rest of your application data can be annoying.

One theorized solution was to use a `WeakHashMap`, keyed by the `Marker`, whose values would be your model objects with the additional data for that `Marker`. The thought was that using a `WeakHashMap` would allow for entries to be garbage-collected when the `Marker` objects were released.

However, as Cyril Mottier pointed out, your `Marker` objects are very short-lived. `GoogleMap` does not hold onto them. Rather, they are merely data structures, passed to the Play Services code via IPC. As a result, your `WeakHashMap` would get rather empty rather quickly.

And, so, we need another plan.

While the Marker objects themselves are used for IPC and released, the *data* inside the Marker passes back and forth between the processes. So, another variation on the original approach is to steal one of the Marker attributes for our own purposes, such as putting a unique identifier for our model in the snippet.

You can see this approach in the [MapsV2/Models](#) sample application, which is a clone of MapsV2/Popup where we use the snippet in just this fashion.

Our simplified model is merely the data we poured into our Marker objects in the original MapsV2/Popup project:

```
package com.commonware.android.mapsv2.model;

import android.content.Context;

public class Model {
    String key;
    String title;
    String snippet;
    double lat;
    double lon;

    Model(Context ctxt, String key, double lat, double lon, int title,
          int snippet) {
        this.key=key;
        this.title=ctxt.getString(title);
        this.snippet=ctxt.getString(snippet);
        this.lat=lat;
        this.lon=lon;
    }

    String getKey() {
        return(key);
    }

    String getTitle() {
        return(title);
    }

    String getSnippet() {
        return(snippet);
    }

    double getLatitude() {
        return(lat);
    }

    double getLongitude() {
```

## MAPPING WITH MAPS V2

---

```
    return(lon);  
  }  
}
```

Our activity holds onto a `HashMap` of these `Model` objects, with the map keyed by the model's key. We need something unique, so in this case we just convert the unique ID of one of our string resources into a string itself and use that as the key:

```
private HashMap<String, Model> models=new HashMap<String, Model>();
```

Of course, a real application would have a much more elaborate setup than this. Perhaps the key would be the `_id` of a `Cursor`, or a natural key of the real data model.

We then arrange to populate our map with `Marker` objects created from our `Model` objects:

```
@Override  
protected void onCreate(Bundle savedInstanceState) {  
    super.onCreate(savedInstanceState);  
  
    Model model=  
        new Model(this, String.valueOf(R.string.un),  
                  40.748963847316034, -73.96807193756104, R.string.un,  
                  R.string.united_nations);  
  
    models.put(model.getKey(), model);  
  
    model=  
        new Model(this, String.valueOf(R.string.lincoln_center),  
                  40.76866299974387, -73.98268461227417,  
                  R.string.lincoln_center,  
                  R.string.lincoln_center_snippet);  
    models.put(model.getKey(), model);  
  
    model=  
        new Model(this, String.valueOf(R.string.carnegie_hall),  
                  40.765136435316755, -73.97989511489868,  
                  R.string.carnegie_hall, R.string.practice_x3);  
    models.put(model.getKey(), model);  
  
    model=  
        new Model(this, String.valueOf(R.string.downtown_club),  
                  40.70686417491799, -74.01572942733765,  
                  R.string.downtown_club, R.string.heisman_trophy);  
    models.put(model.getKey(), model);  
  
    if (readyToGo()) {  
        setContentView(R.layout.activity_main);  
    }  
}
```

## MAPPING WITH MAPS V2

```
SupportMapFragment mapFrag=  
(SupportMapFragment)getSupportFragmentManager().findFragmentById(R.id.map);  
  
initListNav();  
  
map=mapFrag.getMap();  
  
if (savedInstanceState == null) {  
    CameraUpdate center=  
        CameraUpdateFactory.newLatLng(new LatLng(40.76793169992044,  
                                                    -73.98180484771729));  
    CameraUpdate zoom=CameraUpdateFactory.zoomTo(15);  
  
    map.moveCamera(center);  
    map.animateCamera(zoom);  
}  
  
addMarkers(map);  
  
map.setInfoWindowAdapter(new PopupAdapter(getLayoutInflater(),  
                                           models));  
map.setOnInfoWindowClickListener(this);  
}  
}
```

```
private void addMarkers(GoogleMap map) {  
    for (Model model : models.values()) {  
        LatLng position=  
            new LatLng(model.getLatitude(), model.getLongitude());  
  
        map.addMarker(new MarkerOptions().position(position)  
                    .title(model.getTitle())  
                    .snippet(model.getKey()));  
    }  
}
```

Notice that, as we build the Marker, we do not put the value of `getSnippet()` into the Marker's snippet. Instead, we put the key. This allows us to let the Maps V2 engine track the ID of the Marker and give us our key when we need it, such as when we need to display an info window.

Our `PopupAdapter`, though, needs the real snippet when it comes time to populate the contents of an info window. So, we use the supplied snippet — really our key — to look up the real snippet by means of our `HashMap`, supplied to `PopupAdapter` via its constructor:

```
package com.commonware.android.mapsv2.model;
```

## MAPPING WITH MAPS V2

```
import android.view.LayoutInflater;
import android.view.View;
import android.widget.TextView;
import java.util.HashMap;
import com.google.android.gms.maps.GoogleMap.InfoWindowAdapter;
import com.google.android.gms.maps.model.Marker;

class PopupAdapter implements InfoWindowAdapter {
    LayoutInflater inflater=null;
    HashMap<String, Model> models=null;

    PopupAdapter(LayoutInflater inflater, HashMap<String, Model> models) {
        this.inflater=inflater;
        this.models=models;
    }

    @Override
    public View getInfoWindow(Marker marker) {
        return(null);
    }

    @Override
    public View getInfoContents(Marker marker) {
        View popup=inflater.inflate(R.layout.popup, null);

        TextView tv=(TextView)popup.findViewById(R.id.title);

        tv.setText(marker.getTitle());
        tv=(TextView)popup.findViewById(R.id.snippet);
        tv.setText(models.get(marker.getSnippet()).getSnippet());

        return(popup);
    }
}
```

Visually, this is indistinguishable from the original MapsV2/Popups project. Of course, a real app would have more complex models, perhaps containing more discrete information for a more complex info window.

## A Bit More About IPC

IPC is not only a problem in terms of disappearing Marker objects.

If you run a Maps V2 app under [Traceview](#), to see what methods get called and how much time everything takes, you will see that many, many operations with GoogleMap do little in your process, but instead make synchronous calls to a Play Services process to do the real work:

## MAPPING WITH MAPS V2

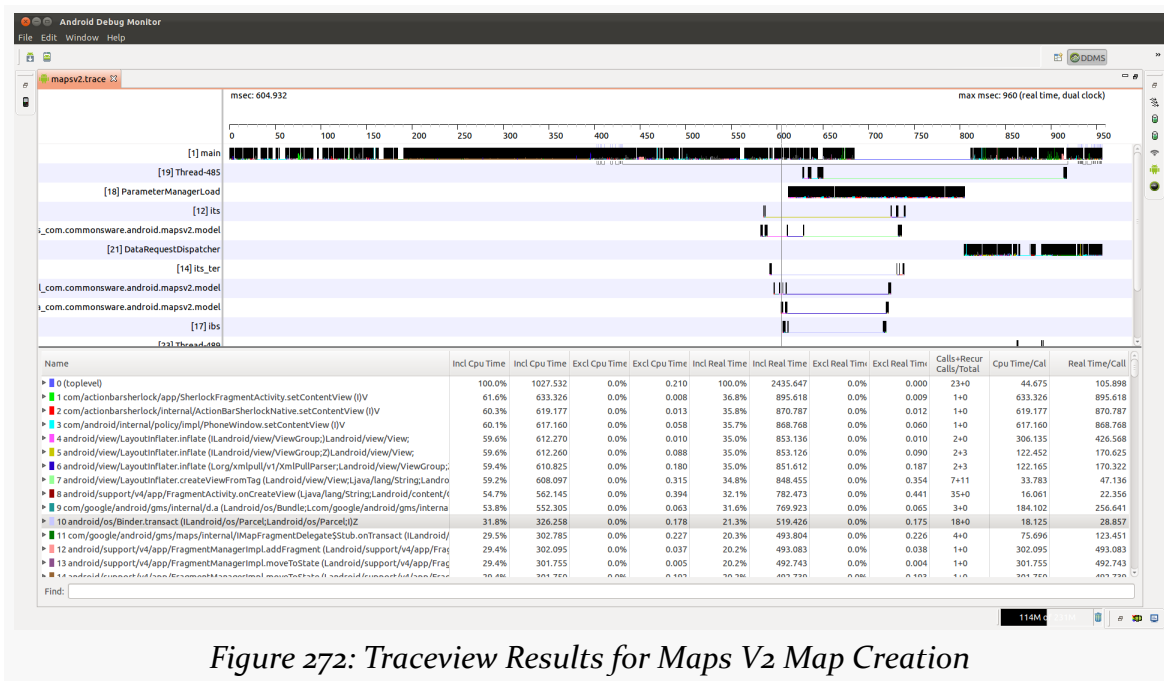


Figure 272: Traceview Results for Maps V2 Map Creation

The preceding trace came from just the onCreate() method of the MapsV2/Models sample from the preceding section. Over 30% of the time to run onCreate() is tied up in IPC calls. And, unfortunately, you are not allowed to do much manipulation of a GoogleMap from a background thread (e.g., moveCamera()).

The moral of this story is to avoid manipulating your GoogleMap in time-sensitive portions of your code.

(the author would once again like to thank Cyril Mottier for pointing out this limitation in Maps V2)

## Finding the User

Many times, the user is looking at a map to figure out where they are. Perhaps they are lost. Perhaps their spouse or significant other thinks that they are lost. Perhaps they think that they were teleported somewhere (e.g., a North African desert) after turning a “frozen wheel” in an icy cavern beneath an island, and therefore are really lost. Stranger things have happened.

(well, OK, perhaps not)



Regardless, it is often useful to help point out to the user their current location. That is a matter of adding a suitable location permission (e.g., `ACCESS_FINE_LOCATION`) and calling `setMyLocationEnabled(true)` on your `GoogleMap`. This activates a layer that will highlight their location, with the user having an option of having the “camera” (i.e., their perspective on the map) reposition itself to their location and move as they move. This latter capability is activated by a small icon in the upper right of the map.

This is nice and easy.

However, there does not appear to be a way to *force* camera tracking of the user’s position — you are reliant upon the user tapping that icon. You also have no control over the nature of the location provider that is used.

However, there is a workaround for this, proposed in [a StackOverflow answer](#) – provide your own location data and update the camera yourself, by means of `setLocationSource()`. `setLocationSource()` lets you push locations to the `GoogleMap`, making other adjustments (e.g., camera position) along the way.

To see how this works, take a peek at the [MapsV2/Location](#) sample application, which is a clone of `MapsV2/Popup` with location tracking enabled.

Along with adding `ACCESS_FINE_LOCATION` to the manifest, this sample project adds four lines to the `onCreate()` implementation of `MainActivity` to configure the `GoogleMap`:

```
locMgr=(LocationManager) getSystemService(LOCATION_SERVICE);
crit.setAccuracy(Criteria.ACCURACY_FINE);

map.setMyLocationEnabled(true);
map.getUiSettings().setMyLocationButtonEnabled(false);
```

The first two lines get access to a `LocationManager` and indicate that a `Criteria` object (initialized as a data member) should require fine accuracy. These come from the [location tracking](#) subsystem in Android.

The next line turns on location tracking in the `GoogleMap`, so the user’s position will be marked on the map.

The last line disables the user’s control over whether the camera position tracks their movement, since we want that to always be on in this case.

## MAPPING WITH MAPS V2

---

In `onResume()` and `onPause()` of `MainActivity`, we enable and disable getting location updates, as is typical of an activity needing location data. However, we also tell the `GoogleMap` that we are going to supply it with location data, rather than it having to obtain location data itself:

```
@Override
public void onResume() {
    super.onResume();

    locMgr.requestLocationUpdates(0L, 0.0f, crit, this, null);
    map.setLocationSource(this);
}

@Override
public void onPause() {
    map.setLocationSource(null);
    locMgr.removeUpdates(this);

    super.onPause();
}
```

The call to `setLocationSource()` tells `GoogleMap` that our `MainActivity` itself is to be the source of location data. This requires `MainActivity` to implement the `LocationSource` interface, requiring us to implement `activate()` and `deactivate()` methods:

```
@Override
public void activate(OnLocationChangeListener listener) {
    this.mapLocationListener=listener;
}

@Override
public void deactivate() {
    this.mapLocationListener=null;
}
```

`activate()` provides us with an `OnLocationChangeListener`, from `GoogleMap`, to which we need to pass location data as we get it. `deactivate()` indicates that we should no longer attempt to contact that listener. In addition to holding onto that listener (or removing our reference to it when deactivated), we also take this opportunity to request and remove location updates.

The `onLocationChanged()` method — where we get our location fixes from `LocationManager` via the `LocationListener` interface — must pass the location along to the `GoogleMap`-supplied `OnLocationChangeListener`, if we have such a listener available:

```
@Override
public void onLocationChanged(Location location) {
    if (mapLocationListener != null) {
        mapLocationListener.onLocationChanged(location);

        LatLng latLng=
            new LatLng(location.getLatitude(), location.getLongitude());
        CameraUpdate cu=CameraUpdateFactory.newLatLng(latLng);

        map.animateCamera(cu);
    }
}
```

Here, we also create a `CameraUpdate` representing the new location and animate that update, to have the map slide over to the new location, centering the camera on the user's updated position.

The net effect of all of this is that the map continuously re-centers itself to show the user's position, which `GoogleMap` is highlighting on the map for us.

## Drawing Lines and Areas

If you wanted to draw on a map in the Maps V1 framework, you created an `Overlay` and drew upon it. This forced you to handle low-level drawing work yourself, as you were handed a `Canvas` object and had to handle all the lines, fills, and so forth yourself.

Maps V2 offers a different approach. Free-form drawing is still conceivable, though it appears to have to be handled in the form of tile overlays instead of map overlays. However, for the simpler cases of drawing lines and areas, Maps V2 has built-in polyline and polygon support. You tell the `GoogleMap` what needs to be drawn, and it handles drawing it, both initially and as the map is zoomed or panned. A polyline is a line connecting a series of points; a polygon is a region defined by a series of corners.

We can see polylines and polygons on a `GoogleMap` in the [MapsV2/Poly](#) sample application, which is a clone of `MapsV2/Popup` with two additions:

- A polyline connecting the locations of our four markers
- A polygon enclosing the area of Manhattan known as the Garment District (bounded by 34th Street, 42nd Street, Fifth Avenue, and Ninth Avenue)

To draw those, we simply add a few lines to `onCreate()` of `MainActivity`:

## MAPPING WITH MAPS V2

---

```
PolylineOptions line=
    new PolylineOptions().add(new LatLng(40.70686417491799,
        -74.01572942733765),
        new LatLng(40.76866299974387,
        -73.98268461227417),
        new LatLng(40.765136435316755,
        -73.97989511489868),
        new LatLng(40.748963847316034,
        -73.96807193756104))
        .width(5).color(Color.RED);

map.addPolyline(line);

PolygonOptions area=
    new PolygonOptions().add(new LatLng(40.748429, -73.984573),
        new LatLng(40.753393, -73.996311),
        new LatLng(40.758393, -73.992705),
        new LatLng(40.753484, -73.980882))
        .strokeColor(Color.BLUE);

map.addPolygon(area);
```

The API for adding polylines and polygons is reminiscent of the API for adding markers: define an `...Options` object with the characteristics of the item to be drawn, then call an `add...()` method on `GoogleMap` to add the item.

So, to add a polyline, we create a `PolylineOptions` object. Using its fluent interface, we `add()` a series of `LatLng` objects, representing the points to be connected by the line. We also specify the line width in *pixels* via `width()` and the color of the line via `color()`. If we had several lines that might overlap, we could specify the `zIndex()`, where higher indexes indicate lines to be drawn over top of lines with lower indexes. We add the polyline to the map by passing our `PolylineOptions` to `addPolyline()` on `GoogleMap`.

This gives us a line connecting the four markers, with `GoogleMap` handling the details of where the line should be drawn on the screen given the current map center and zoom levels:

## MAPPING WITH MAPS V2

---

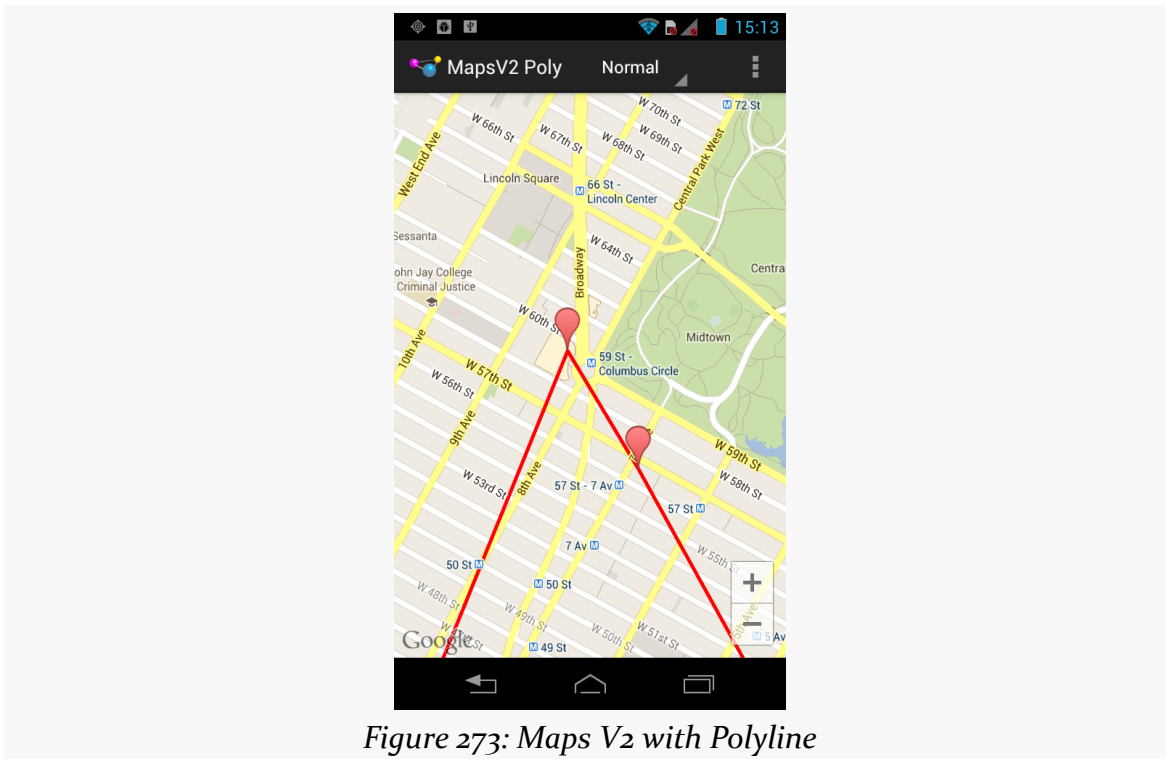


Figure 273: Maps V2 with Polyline

Note that the polyline is drawn using a flat Mercator projection by default. For most maps, that is perfectly fine. If your map will be showing countries and continents, rather than city blocks, you might want to call `geodesic(true)` on the `PolylineOptions`, to have the line drawn on a geodesic curve, reflecting the spherical nature of the Earth ([dissenting opinions on that](#) notwithstanding).

Similarly, we create a `PolygonOptions` object, configure it, and pass it to `addPolygon` for our Garment District box. The `add()` method on `PolygonOptions` will take the corners of our polygon, automatically enclosing that region. We also specify the `strokeColor()`. We could have specified a `fillColor()` (default is transparent), `strokeWidth()` (default is 10 pixels), `zIndex()`, and `geodesic()`.

If we run the app and pan the map down to the south a bit, we see our polygon:

## MAPPING WITH MAPS V2

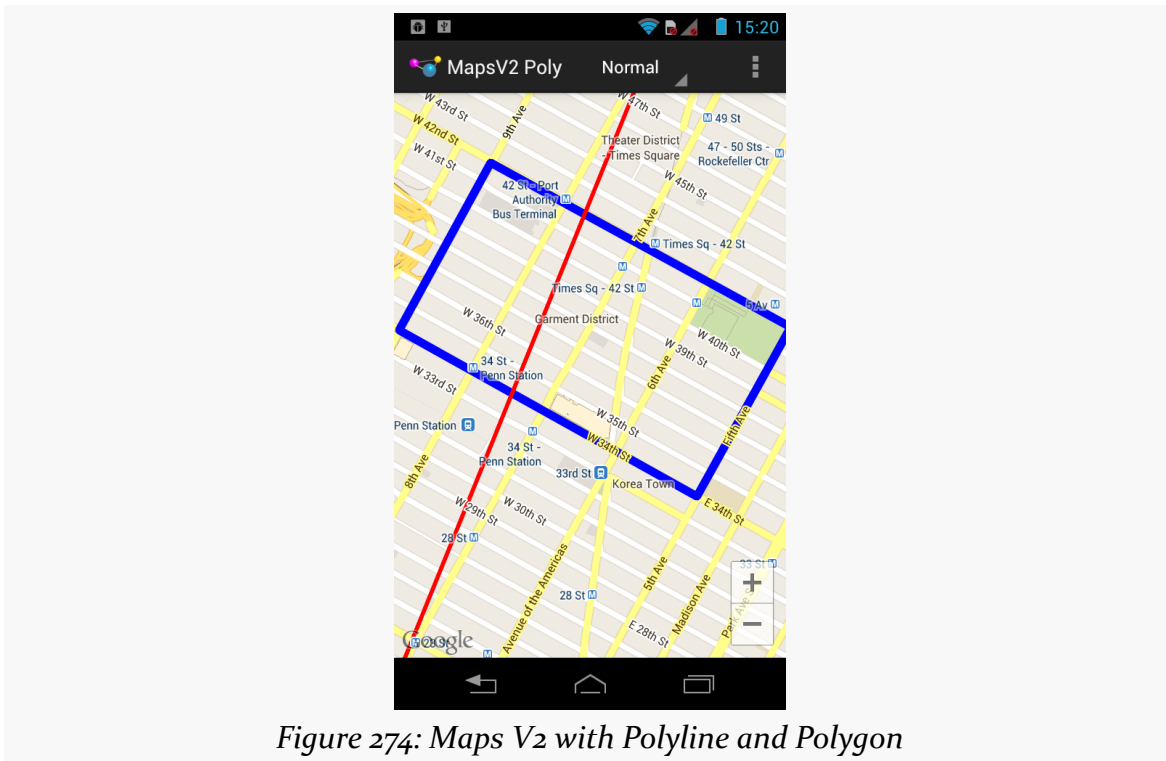


Figure 274: Maps V2 with Polyline and Polygon

As with the polyline, Android automatically handles drawing what is needed based on map center and zoom levels.

Note that, as with markers, we need to add the polylines and polygons after a configuration change, as the GoogleMap does not retain that information.

## Gestures and Controls

By default, standard gestures and controls are enabled on your map:

- The user can change zoom level either by + and - buttons or via “pinch-to-zoom” gestures
- The user can change the center of the map via simple swipe gestures
- The user can change the camera tilt via two-finger vertical swipes, so instead of a traditional top-down perspective, the user can see things on an angle
- The user can change the orientation of the map via a two-finger rotating swipe, to change the typical “north is to the top of the map” to some other orientation

You can obtain a `UiSettings` object from your `GoogleMap` via `getUiSettings()` to disable these features, if desired:

- `setRotateGesturesEnabled()`
- `setScrollGesturesEnabled()` (for panning the map)
- `setTiltGesturesEnabled()`
- `setZoomControlsEnabled()` (for the + and - buttons)
- `setZoomGesturesEnabled()` (for pinch-to-zoom)

There is also `setAllGesturesEnabled()` to toggle on or off all gesture-based map control. This is roughly analogous to the `android:clickable` attribute on the Maps V1 edition of `MapView`.

There is also `setCompassEnabled()`, to indicate if a compass should be shown if the user changes the map orientation via a rotate gesture.

## Tracking Camera Changes

If you have gestures enabled, the user can change the perspective of the map, referred to as changing the camera position. You may need to know about these changes, to perform various operations in your app based upon what is presently visible on the screen. To find out when the camera position changes, you can call `setOnCameraChangeListener()` on the `GoogleMap`, supplying an implementation of `OnCameraChangeListener`, which will be called with `onCameraChange()` as the user pans, zooms, or tilts the map.

To see how this works, we can take a quick peek at the [MapsV2/Camera](#) sample application, which is a clone of `MapsV2/Popup` with camera position tracking enabled.

Late in `onCreate()` of `MainActivity`, we call `setOnCameraChangeListener()` on our `GoogleMap`, supplying `MainActivity` itself as the listener:

```
map.setOnCameraChangeListener(this);
```

This requires `MainActivity` to implement `OnCameraChangeListener` and supply an implementation of `onCameraChange()`:

```
@Override
public void onCameraChange(CameraPosition position) {
    Log.d(getClass().getSimpleName(),
        String.format("lat: %f, lon: %f, zoom: %f, tilt: %f",
```

## MAPPING WITH MAPS V2

---

```
        position.target.latitude,  
        position.target.longitude, position.zoom,  
        position.tilt));  
    }
```

Here, we just log a message to LogCat on each camera position change, logging:

- the latitude and longitude of the map center, obtained from the target `LatLng` data member of the `CameraPosition` object supplied to `onCameraChange()`,
- the zoom level of the map, from the zoom data member of `CameraPosition`, and
- the tilt of the map, in degrees, from the tilt data member of `CameraPosition`

As a result, if you run this app and play around with the various gestures, you get a series of LogCat messages with the results:

```
12-26 15:36:39.456: D/MainActivity(31419): lat: 40.763727, lon: -73.983163,  
zoom: 15.000000, tilt: 0.000000  
12-26 15:36:39.536: D/MainActivity(31419): lat: 40.763797, lon: -73.983118,  
zoom: 15.000000, tilt: 0.000000  
12-26 15:36:40.796: D/MainActivity(31419): lat: 40.767982, lon: -73.979181,  
zoom: 15.000000, tilt: 0.000000  
12-26 15:36:41.966: D/MainActivity(31419): lat: 40.766275, lon: -73.981911,  
zoom: 15.000000, tilt: 0.000000  
12-26 15:36:42.216: D/MainActivity(31419): lat: 40.765145, lon: -73.983651,  
zoom: 15.000000, tilt: 0.000000  
12-26 15:36:43.526: D/MainActivity(31419): lat: 40.765165, lon: -73.983583,  
zoom: 15.000000, tilt: 0.000000  
12-26 15:36:44.176: D/MainActivity(31419): lat: 40.765685, lon: -73.981983,  
zoom: 15.875862, tilt: 0.000000  
12-26 15:36:44.236: D/MainActivity(31419): lat: 40.765685, lon: -73.981983,  
zoom: 15.875862, tilt: 0.000000  
12-26 15:36:45.566: D/MainActivity(31419): lat: 40.766083, lon: -73.982028,  
zoom: 15.875862, tilt: 11.015625  
12-26 15:36:45.616: D/MainActivity(31419): lat: 40.766083, lon: -73.982028,  
zoom: 15.875862, tilt: 16.171875  
12-26 15:36:45.666: D/MainActivity(31419): lat: 40.766083, lon: -73.982028,  
zoom: 15.875862, tilt: 24.375000  
12-26 15:36:45.726: D/MainActivity(31419): lat: 40.766083, lon: -73.982028,  
zoom: 15.875862, tilt: 38.671875  
12-26 15:36:45.776: D/MainActivity(31419): lat: 40.766083, lon: -73.982028,  
zoom: 15.875862, tilt: 45.234375  
12-26 15:36:45.816: D/MainActivity(31419): lat: 40.766083, lon: -73.982028,  
zoom: 15.875862, tilt: 48.046875  
12-26 15:36:45.846: D/MainActivity(31419): lat: 40.766083, lon: -73.982028,  
zoom: 15.875862, tilt: 50.859375  
12-26 15:36:45.886: D/MainActivity(31419): lat: 40.766083, lon: -73.982028,  
zoom: 15.875862, tilt: 52.968750
```



```
12-26 15:36:45.926: D/MainActivity(31419): lat: 40.766083, lon: -73.982028,
zoom: 15.875862, tilt: 56.484375
12-26 15:36:45.966: D/MainActivity(31419): lat: 40.766083, lon: -73.982028,
zoom: 15.875862, tilt: 57.890625
12-26 15:36:46.096: D/MainActivity(31419): lat: 40.766083, lon: -73.982028,
zoom: 15.875862, tilt: 59.296875
```

## Maps in Fragments and Pagers

One key limitation of Maps V1 was that you could only have one `MapView` instance per *process*. Presumably, the proprietary code at the heart of the Maps SDK add-on used static data members for some state management, ones that would get messed up if there were two or more `MapView` widgets in active use.

Fortunately, Maps V2 gets rid of this restriction. You are welcome to have multiple `MapFragment` objects if that makes sense. Maps are relatively memory-intensive, so you should not be planning on having dozens or hundreds of them in use at a time, but you can have more than one.

To showcase this, the [MapsV2/Pager](#) sample application hosts 10 `SupportMapFragment` instances as pages in a `ViewPager`. The bulk of the application is a clone of one of the `ViewPager` samples from [the chapter on ViewPager](#).

Our activity inflates a layout that contains our `ViewPager` along with a `PagerTabStrip`:

```
<?xml version="1.0" encoding="utf-8"?>
<android.support.v4.view.ViewPager xmlns:android="http://schemas.android.com/apk/res/android"
    android:id="@+id/pager"
    android:layout_width="fill_parent"
    android:layout_height="fill_parent">

    <android.support.v4.view.PagerTabStrip
        android:layout_width="fill_parent"
        android:layout_height="wrap_content"
        android:layout_gravity="top"/>

</android.support.v4.view.ViewPager>
```

`MainActivity` then populates the `ViewPager` with an instance of a `MapPagerAdapter`:

```
package com.commonware.android.mapsv2.pager;
import android.os.Bundle;
import android.support.v4.view.PagerAdapter;
```

## MAPPING WITH MAPS V2

---

```
import android.support.v4.view.ViewPager;

public class MainActivity extends AbstractMapActivity {
    @Override
    protected void onCreate(Bundle savedInstanceState) {
        super.onCreate(savedInstanceState);

        if (readyToGo()) {
            setContentView(R.layout.activity_main);

            ViewPager pager=(ViewPager)findViewById(R.id.pager);

            pager.setAdapter(buildAdapter());
        }
    }

    private PagerAdapter buildAdapter() {
        return(new MapPagerAdapter(this, getSupportFragmentManager()));
    }
}
```

MapPagerAdapter is a FragmentStatePagerAdapter, not a FragmentPagerAdapter. This means that as the user swipes through our ViewPager, the adapter has the right to discard old fragments when it creates new ones. This helps reduce the overall memory footprint of our activity.

```
package com.commonware.android.mapsv2.pager;

import android.content.Context;
import android.support.v4.app.Fragment;
import android.support.v4.app.FragmentManager;
import android.support.v4.app.FragmentStatePagerAdapter;

public class MapPagerAdapter extends FragmentStatePagerAdapter {
    Context ctxt=null;

    public MapPagerAdapter(Context ctxt, FragmentManager mgr) {
        super(mgr);
        this.ctxt=ctxt;
    }

    @Override
    public int getCount() {
        return(10);
    }

    @Override
    public Fragment getItem(int position) {
        return(new PageMapFragment());
    }

    @Override
```

## MAPPING WITH MAPS V2

---

```
public String getPageTitle(int position) {
    return(ctxt.getString(R.string.map_page_title) + String.valueOf(position +
1));
}
}
```

MapPagerAdapter declares that there should be ten pages (in getCount()) and returns an instance of PageMapFragment for each page. PageMapFragment is a subclass of SupportMapFragment, and so is responsible for displaying our map:

```
package com.commonsware.android.mapsv2.pager;

import android.os.Bundle;
import com.google.android.gms.maps.CameraUpdate;
import com.google.android.gms.maps.CameraUpdateFactory;
import com.google.android.gms.maps.GoogleMap;
import com.google.android.gms.maps.SupportMapFragment;
import com.google.android.gms.maps.model.LatLng;
import com.google.android.gms.maps.model.MarkerOptions;

public class PageMapFragment extends SupportMapFragment {
    @Override
    public void onActivityCreated(Bundle savedInstanceState) {
        super.onActivityCreated(savedInstanceState);

        GoogleMap map=getMap();

        if (savedInstanceState == null) {
            CameraUpdate center=
                CameraUpdateFactory.newLatLng(new LatLng(40.76793169992044,
                    -73.98180484771729));
            CameraUpdate zoom=CameraUpdateFactory.zoomTo(15);

            map.moveCamera(center);
            map.animateCamera(zoom);
        }

        addMarker(map, 40.748963847316034, -73.96807193756104, R.string.un,
            R.string.united_nations);
        addMarker(map, 40.76866299974387, -73.98268461227417,
            R.string.lincoln_center, R.string.lincoln_center_snippet);
        addMarker(map, 40.765136435316755, -73.97989511489868,
            R.string.carnegie_hall, R.string.practice_x3);
        addMarker(map, 40.70686417491799, -74.01572942733765,
            R.string.downtown_club, R.string.heisman_trophy);
    }

    private void addMarker(GoogleMap map, double lat, double lon,
        int title, int snippet) {
        map.addMarker(new MarkerOptions().position(new LatLng(lat, lon))
            .title(getString(title))
            .snippet(getString(snippet)));
    }
}
```

## MAPPING WITH MAPS V2

---

```
}  
}
```

If we simply wanted to display an unconfigured map, we could just have `MapPageAdapter` create and return instances of `SupportMapFragment` directly. If we want to configure our map, though, we need to get control when the `GoogleMap` object is ready for use. One way to do that is to extend `SupportMapFragment` and override `onActivityCreated()`, as `getMap()` should return a non-null value at this point. We can then go ahead and configure the map much as we have done in previous examples, just from within the fragment itself rather than from the hosting activity.

The result is a series of independent maps, one per page:

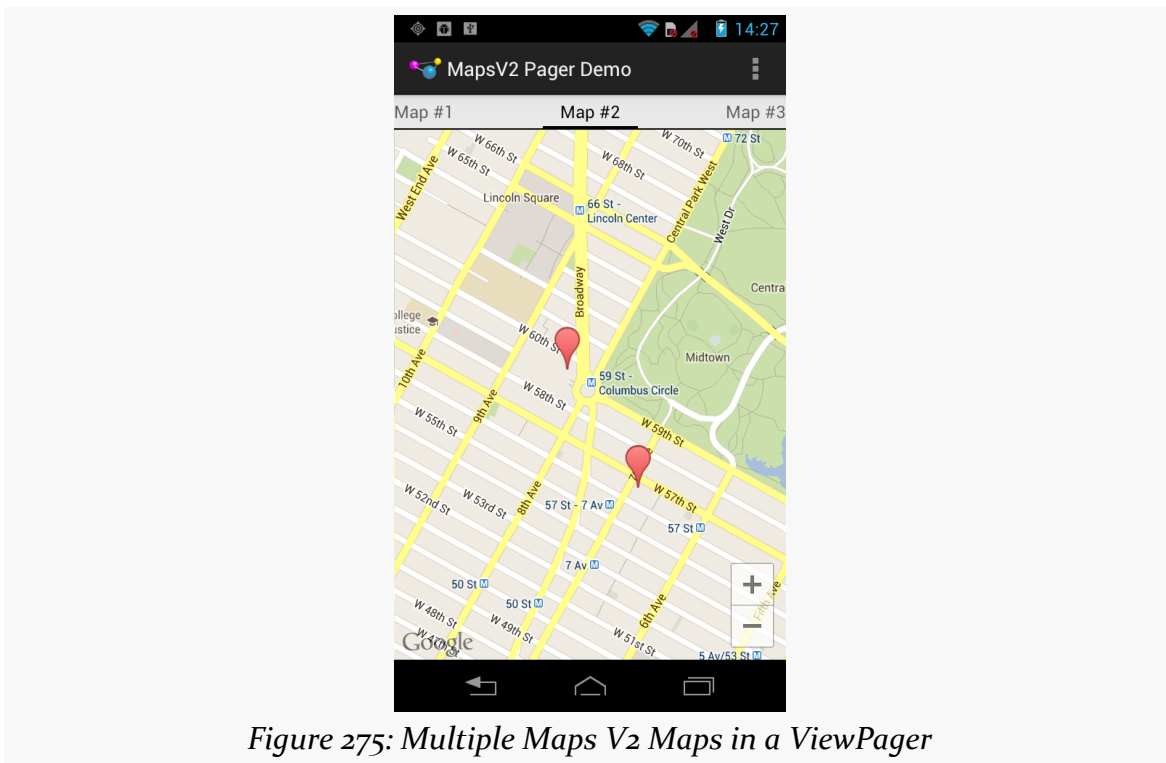


Figure 275: Multiple Maps V2 Maps in a ViewPager

Each map is independent: if the user pans or zooms one map, that has no impact on any of the other pages.

## MapFragment vs. MapView

So far, all the examples shown in this chapter use MapFragment (or, more accurately, SupportMapFragment). In most cases, this is the right thing to use.

However, there may be places where you really want to use a View, rather than a Fragment, for your maps.

The good news is that Maps V2 does have a MapView. MapFragment usually handles creating and managing the MapView for you, but you can, if you wish, eschew MapFragment and manage the MapView yourself.

The biggest limitation is that you need to forward the lifecycle methods from your activity or fragment on to the MapView, calling onCreate(), onResume(), onPause(), onDestroy(), and onSaveInstanceState() on the MapView. Normally, MapFragment would do that for you, saving you the trouble.

Also note that while MapView is a ViewGroup, you are not allowed to add child widgets to it.

## Maps and ActionBarSherlock

All of the samples shown so far in this book have used ActionBarSherlock for their action bar. However, we have been using SupportMapFragment, which itself is not aware of ActionBarSherlock.

This actually works.

While the general pattern is to use a Sherlock version of a fragment class (e.g., SherlockListFragment), anything inheriting from the Android Support Library backport of Fragment will work with ActionBarSherlock... so long as it does not try to manipulate the action bar. SupportMapFragment, on its own, does not touch the action bar, and so we are safe.

However, what if we *do* want our maps to manipulate the action bar, such as adding relevant action bar items? Then, we need a SherlockFragment that also supports a GoogleMap. The Android Support Library is unlikely to supply such a class itself, and of the time of this writing, neither does ActionBarSherlock.

## MAPPING WITH MAPS V2

---

However, it is possible to create such a class... something Alexandre Gherschon did in late 2012, with [his take on a SherlockMapFragment implementation](#).

```
package com.actionbarsherlock.app;

import android.app.Activity;
import android.support.v4.app.Watson.OnCreateOptionsMenuListener;
import android.support.v4.app.Watson.OnOptionsItemSelectedListener;
import android.support.v4.app.Watson.OnPrepareOptionsMenuListener;
import com.actionbarsherlock.app.SherlockFragmentActivity;
import com.actionbarsherlock.internal.view.menu.MenuItemWrapper;
import com.actionbarsherlock.internal.view.menu.MenuWrapper;
import com.actionbarsherlock.view.Menu;
import com.actionbarsherlock.view.MenuInflater;
import com.actionbarsherlock.view.MenuItem;
import com.google.android.gms.maps.SupportMapFragment;

public class SherlockMapFragment extends SupportMapFragment implements
    OnCreateOptionsMenuListener, OnPrepareOptionsMenuListener,
    OnOptionsItemSelectedListener {
    private SherlockFragmentActivity mActivity;

    public SherlockFragmentActivity getSherlockActivity() {
        return mActivity;
    }

    @Override
    public void onAttach(Activity activity) {
        if (!(activity instanceof SherlockFragmentActivity)) {
            throw new IllegalStateException(getClass().getSimpleName()
                + " must be attached to a SherlockFragmentActivity.");
        }
        mActivity=(SherlockFragmentActivity)activity;

        super.onAttach(activity);
    }

    @Override
    public void onDetach() {
        mActivity=null;
        super.onDetach();
    }

    @Override
    public final void onCreateOptionsMenu(android.view.Menu menu,
        android.view.MenuInflater inflater) {
        onCreateOptionsMenu(new MenuWrapper(menu),
            mActivity.getSupportMenuInflater());
    }

    @Override
    public void onCreateOptionsMenu(Menu menu, MenuInflater inflater) {
        // Nothing to see here.
    }
}
```

## MAPPING WITH MAPS V2

---

```
}

@Override
public final void onPrepareOptionsMenu(android.view.Menu menu) {
    onPrepareOptionsMenu(new MenuWrapper(menu));
}

@Override
public void onPrepareOptionsMenu(Menu menu) {
    // Nothing to see here.
}

@Override
public final boolean onOptionsItemSelected(android.view.MenuItem item) {
    return onOptionsItemSelected(new MenuItemWrapper(item));
}

@Override
public boolean onOptionsItemSelected(MenuItem item) {
    // Nothing to see here.
    return false;
}
}
```

You can then extend `SherlockMapFragment`, creating your own fragment that can, among other things, manipulate the action bar, as seen in the [MapsV2/Sherlock](#) sample application:

```
package com.commonware.android.mapsv2.sherlock;

import android.os.Bundle;
import android.util.Log;
import com.actionbarsherlock.app.SherlockMapFragment;

public class MyMapFragment extends SherlockMapFragment {
    @Override
    public void onActivityCreated(Bundle savedInstanceState) {
        super.onActivityCreated(savedInstanceState);

        if (getMap() != null) {
            Log.d(getClass().getSimpleName(), "Map ready for use!");
        }
    }
}
```

One thing to be careful of, though, is the timing of when you try to use the `GoogleMap` object. For example, in `onCreateView()`, the `GoogleMap` is not yet ready for use. `onActivityCreated()`, as shown in the above code, appears to be a safe alternative.

You can then use your map fragment class wherever you had been using `SupportMapFragment`, such as in a layout resource:

```
<fragment xmlns:android="http://schemas.android.com/apk/res/android"
    android:id="@+id/map"
    android:layout_width="match_parent"
    android:layout_height="match_parent"
    class="com.commonware.android.mapsv2.sherlock.MyMapFragment"/>
```

## About That AbstractMapActivity Class...

Early on, we hand-waved our way past the `AbstractMapActivity` that all of our `MainActivity` classes inherit from, and we skirted past the `readyToGo()` method that we were calling. Also, you may have noticed that our app has an action bar overflow item, that we do not seem to be creating in `MainActivity`.

Now, it is time to dive into what is going on in our `AbstractMapActivity` implementations.

## Getting Maps V2 Ready to Go

The `readyToGo()` method in `AbstractMapActivity` is designed to help us determine if Maps V2 is “ready to go” and, if not, to help the user perhaps fix their device such that Maps V2 will work in the future:

```
protected boolean readyToGo() {
    int status=
        GooglePlayServicesUtil.isGooglePlayServicesAvailable(this);

    if (status == ConnectionResult.SUCCESS) {
        return(true);
    }
    else if (GooglePlayServicesUtil.isUserRecoverableError(status)) {
        AlertDialogFragment.newInstance(status)
            .show(getSupportFragmentManager(),
                TAG_ERROR_DIALOG_FRAGMENT);
    }
    else {
        Toast.makeText(this, R.string.no_maps, Toast.LENGTH_LONG).show();
        finish();
    }

    return(false);
}
```



## MAPPING WITH MAPS V2

---

First, we call the static `isGooglePlayServicesAvailable()` method on `GooglePlayServicesUtil`. This will return an integer indicating whether Maps V2 is available for our use or not. If the return value is `ConnectionResult.SUCCESS` — meaning Maps V2 is indeed available to us — we return `true` from `readyToGo()`, so `MainActivity` knows to continue on setting up the map.

But, what if `isGooglePlayServicesAvailable()` returns something else?

There are two major possibilities here:

1. The error is something that the user might be able to rectify, such as by downloading the Google Play Services app from the Play Store
2. The error is something that the user cannot recover from

We can distinguish these two cases by calling the static `isUserRecoverableError()` on `GooglePlayServicesUtil`, passing in the value we received from `isGooglePlayServicesAvailable()`. This will return `true` if the user might be able to fix the problem, `false` otherwise.

In the `false` case, the user is just out of luck, so we display a `Toast` to alert them of this fact, then `finish()` the activity and return `false`, so `MainActivity` skips over the rest of its work.

In the `true` case, we can display something to the user to prompt them to fix the problem. One way to do that is to use a dialog obtained from Google code, by calling the static `getErrorDialog()` method on the `GooglePlayServicesUtil` class. In our case, we wrap that in a `DialogFragment` named `ErrorDialogFragment`, implemented as a static inner class of `AbstractMapActivity`:

```
public static class ErrorDialogFragment extends DialogFragment {
    static final String ARG_STATUS="status";

    static ErrorDialogFragment newInstance(int status) {
        Bundle args=new Bundle();

        args.putInt(ARG_STATUS, status);

        ErrorDialogFragment result=new ErrorDialogFragment();

        result.setArguments(args);

        return(result);
    }

    @Override
```

## MAPPING WITH MAPS V2

---

```
public Dialog onCreateDialog(Bundle savedInstanceState) {
    Bundle args=getArguments();

    return GooglePlayServicesUtil.getErrorDialog(args.getInt(ARG_STATUS),
                                                getActivity(), 0);
}

@Override
public void onDismiss(DialogInterface dlg) {
    if (getActivity() != null) {
        getActivity().finish();
    }
}
}
```

While the code and comments around `getErrorDialog()` suggest that there is some way for us to find out if the user performed actions that fix the problem, this code does not seem to work well in practice. After all, downloading Google Play Services is asynchronous, so even if the user returns to our app, it is entirely likely that Maps V2 is still unavailable. As a result, when the user is done with the dialog, we `finish()` the activity, forcing the user to start it again if and when they are done downloading Google Play Services.

Testing this code requires an older device, one in which the “Google Play services” app can be uninstalled... if it can be installed at all.

As it turns out, not all Android devices support the Play Store, or the Google Play Services by extension. This leads to unpleasant user experiences:

- If the device [lacks the Play Store](#), `isUserRecoverableError()` returns true, even though the user cannot recover from this situation (except perhaps via a firmware update)
- `getErrorDialog()` apparently [can return null](#) for cases where the error is supposedly user-recoverable

## Handling the License Terms

`AbstractMapActivity` has implementations of `onCreateOptionsMenu()` and `onOptionsItemSelected()` that will add a “Legal Notices” item to the overflow menu and bring up `LegalNoticesActivity` when that menu item is tapped:

```
package com.commonware.android.mapsv2.basic;

import android.os.Bundle;
import android.widget.TextView;
```

---

## MAPPING WITH MAPS V2

---

```
import com.actionbarsherlock.app.SherlockActivity;
import com.google.android.gms.common.GooglePlayServicesUtil;

public class LegalNoticesActivity extends SherlockActivity {
    @Override
    protected void onCreate(Bundle savedInstanceState) {
        super.onCreate(savedInstanceState);
        setContentView(R.layout.legal);

        TextView legal=(TextView)findViewById(R.id.legal);

        legal.setText(GooglePlayServicesUtil.getOpenSourceSoftwareLicenseInfo(this));
    }
}
```

LegalNoticesActivity simply has a TextView inside of a ScrollView and fills in the TextView with the results of calling `getOpenSourceSoftwareLicenseInfo()` on `GooglePlayServicesUtil`. This method returns the legalese that you need to display to the users from somewhere in your app.

## Problems with Maps V2 at Runtime

Portions of the logic that powers your Maps V2 MapFragment is supplied by the Google Play Services app. As a result, many operations with Maps V2, such as manipulating markers, require IPC calls between your app and Google Play Services. If those IPC calls are synchronous, they will add a bit of overhead to your app — enough that you will want to avoid them in time-critical pieces of code, tight loops, and the like.

Some developers report [seeing black regions being left behind](#) during animations of a map, such as sliding between ViewPager pages. Various workarounds are discussed in the linked-to StackOverflow question. At this time, the leading workaround, [supplied by Jeff Gilfelt](#), involves putting a transparent frame on top of the map. According to Google engineers, [the issue](#) ties back to the GLSurfaceView used for drawing the map.

## Problems with Maps V2 Deployment

Of course, the key question is: should you be using Maps V2 at all?

Google thinks so, as they are [turning off access to new API keys for Maps V1](#) in early March 2013. That makes ongoing development of Maps V1 solutions a bit risky, as

you cannot create new API keys for new signing keys (e.g., need to replace your debug keystore).

However, Maps V2 has serious deployment limitations at this time:

- It requires OpenGL ES 2.0, which eliminates many old devices
- Some devices that are relatively new in terms of OS level (e.g., Android 2.3) may still have OpenGL ES 1.1
- Devices that have a suitable OpenGL ES version may not have the Play Store or otherwise be unable to get Google Play Services, required for using Maps V2, and there is no known way to determine that this is the case
- The logic in the current Play Services SDK to help the user obtain the Google Play Services appears unreliable, crashing in unexpected ways

By API Level 11 (Android 3.0), the deployment environment should be stable, at least once the user has obtained Google Play Services (which, for many people, will be automatic). It is the Android 2.2 and 2.3 devices that appear to be a problem.

If you are not supporting Android 2.x, or if you are deploying in a constrained environment (e.g., small business) with only so many users and devices, using Maps V2 would seem to be a reasonable choice. In the latter case, if you determine that too many of your users' devices cannot use Maps V2, then you will need to reconsider, or attempt to use both Maps V1 *and* Maps V2.

## Mapping Alternatives

Beyond using Maps V2 or Maps V1, you may need to consider other mapping alternatives. The Google mapping APIs are only available on Android devices that have the Maps SDK add-on (Maps V1) or Google Play Services (Maps V2). Not all devices have those. And, the limitations of Maps V2 deployment and the deprecation of Maps V1 may convince you that relying upon Google for maps is not safe at the present time.

The most common native replacement for Google's mapping is [OpenStreetMap](#), which to some extent is "the Wikipedia of maps". [OSMDroid](#) is a library that provides a Maps V1-ish API for embedding OpenStreetMap-based maps into your application.

Another solution is to integrate Web-based Google maps into your app, the same way that you might embed them into your Web site. An activity hosting a `WebView` can display a Web-based Google Map, for example.

Certain devices may have access to other native mapping solutions. For example, Amazon has published [their own maps API](#) for use with the Kindle Fire.

### Getting Help

The official support point for Maps V2 for Android is StackOverflow. Questions [tagged with both android and google-maps](#) should show up on Google's radar.

# Mapping with the Legacy MapView

---

[Maps V2](#) is a fine solution for Android 3.0+, but has its issues with older devices. Some older devices cannot obtain the Google Play Services subsystem that supplies us with the newer maps, and some older devices lack the OpenGL ES 2.0 graphics capability necessary for the newer maps.

Hence, for older devices, Maps V1 — the old Android SDK add-on — will be your primary option for integrated mapping.

First, we cover the basics of getting Maps V1 integrated into your application, including the current challenges when using maps with fragments. Then we discuss how you can [convert from latitude and longitude to screen coordinates](#) on the current map. We then investigate what it takes to [layer things on top of the map](#), such as a persistent pop-up panel instead of using a transient Toast to display something in response to a tap. Next, we look at how to have [custom icons per item](#) in an `ItemizedOverlay`, rather than having everything in the overlay look the same. We wrap up with coverage of how to load up the contents of an `ItemizedOverlay` [asynchronously](#), in case that might take a while and should not be done on the main application thread.

## Prerequisites

Understanding this chapter requires that you have read the core chapters, along with [the chapter on drawables](#). Having read the chapter on [Maps V2](#) is not required though not a bad idea.

## Terms, Not of Endearment

Google Maps, particularly when integrated into third party applications, requires agreeing to a fairly lengthy set of legal terms. These terms include clauses that you may find unpalatable.

If you are considering Google Maps, please review these terms closely to determine if your intended use will not run afoul of any clauses. You are strongly recommended to seek professional legal counsel if there are any potential areas of conflict.

## Piling On

Google Maps are not strictly part of the Android SDK. Instead, they are part of the Google APIs Add-On, an extension of the stock SDK. The Android add-on system provides hooks for other subsystems that may be part of some devices, but not others.

After all, Google Maps is not part of the Android open source project, and undoubtedly there will be some devices that lack Google Maps due to licensing issues. Notable among these are the Kindle Fire and the NOOK series of tablets.

By and large, the fact that Google Maps is in an add-on does not affect your day-to-day development. However, bear in mind:

1. You will need to create your project with an appropriate target to ensure the Google Maps APIs will be available
2. To test your Google Maps integration, you will also need an AVD that uses an appropriate target

## The Key To It All

If you download the source code for the book, compile the [Maps/NooYawk](#) project, install it in your emulator, and run it, you will probably see a screen with a grid and a couple of push-pins, but no actual maps.

That is because the API key in the source code is invalid for your development machine. Instead, you will need to generate your own API key(s) for use with your application. This also holds true for any map-enabled projects you create on your own from scratch.

## MAPPING WITH THE LEGACY MAPVIEW

---

**WARNING:** As of March 3, 2013, access to *new* Maps V1 API keys is scheduled to be turned off. Existing keys should continue to work.

Full instructions for generating API keys, for development and production use, can be found on the [Google Maps add-on site](#). In the interest of brevity, let's focus on the narrow case of getting NooYawk running in your emulator. Doing this requires the following steps:

- Visit the API key signup page and review the terms of service.
- Re-read those terms of service and make really sure you want to agree to them.
- Find the MD5 digest of the certificate used for signing your debug-mode applications (described in detail below)
- On the API key signup page, paste in that MD5 signature and submit the form
- On the resulting page, copy the API key and paste it as the value of `apiKey` in your MapView-using layout

The trickiest part is finding the MD5 signature of the certificate used for signing your debug-mode applications... and much of the complexity is merely in making sense of the concept.

All Android applications are signed using a digital signature generated from a certificate. You are automatically given a debug certificate when you set up the SDK, and there is a separate process for creating a self-signed certificate for use in your production applications. This signature process involves the use of the Java `keytool` and `jarsigner` utilities. For the purposes of getting your API key, you only need to worry about `keytool`.

To get your MD5 digest of your debug certificate, if you are on OS X or Linux, use the following command:

```
keytool -list -alias androiddebugkey -keystore ~/.android/debug.keystore
-storepass android -keypass android
```

(NOTE: the above should be all on one line, but may word-wrap in your digital book reader)

On other development platforms, you will need to replace the value of the `-keystore` switch with the location for your platform and user account:

1. XP: `C:\Documents and Settings\%USER\.android\debug.keystore`



2. Vista/Windows 7: C:\Users\%USER\.android\debug.keystore

(where %USER is your account name)

The second line of the output contains your MD5 digest, as a series of pairs of hex digits separated by colons.

NOTE: Java 7 has a different version of `keytool`, one that generates an SHA hash by default. Use the `-v` switch to have the Java 7 `keytool` emit the MD5 hash as well. Note that the Android development tools do not officially support Java 7 as of the time of this writing.

## The Bare Bones

To put a map into your application, you need to create your own subclass of `MapActivity`. Like `ListActivity`, which wraps up some of the smarts behind having an activity dominated by a `ListView`, `MapActivity` handles some of the nuances of setting up an activity dominated by a `MapView`. A `MapView` can only be used by a `MapActivity`, not any other type of `Activity`.

In your layout for the `MapActivity` subclass, you need to add an element named `com.google.android.maps.MapView`. This is the “longhand” way to spell out the names of widget classes, by including the full package name along with the class name. This is necessary because `MapView` is not in the `android.widget` namespace. You can give the `MapView` widget whatever `android:id` attribute value you want, plus handle all the layout details to have it render properly alongside your other widgets.

However, you do need to have:

1. `android:apiKey`, your Google Maps API key
2. `android:clickable = "true"`, if you want users to be able to click and pan through your map

For example, from the Maps/NooYawk sample application, here is the main layout:

```
<?xml version="1.0" encoding="utf-8"?>
<RelativeLayout xmlns:android="http://schemas.android.com/apk/res/android"
    android:layout_width="fill_parent"
    android:layout_height="fill_parent">
    <com.google.android.maps.MapView android:id="@+id/map"
        android:layout_width="fill_parent"
        android:layout_height="fill_parent"
```

## MAPPING WITH THE LEGACY MAPVIEW

---

```
        android:apiKey="0mj160ufrY-tHs6WFurtL7rsYyEMpdEqBCbyjXg"
        android:clickable="true" />
</RelativeLayout>
```

In addition, you will need a couple of extra things in your `AndroidManifest.xml` file:

1. The `INTERNET` permission, as the map tiles need to be downloaded by your process
2. Inside your `<application>`, a `<uses-library>` element with `android:name = "com.google.android.maps"`, to indicate you are using one of the optional Android APIs

Here is the `AndroidManifest.xml` file for `NooYawk`:

```
<?xml version="1.0" encoding="utf-8"?>
<manifest xmlns:android="http://schemas.android.com/apk/res/android"
    package="com.commonware.android.maps">

    <supports-screens
        android:anyDensity="true"
        android:largeScreens="true"
        android:normalScreens="true"
        android:smallScreens="true"/>

    <uses-sdk
        android:minSdkVersion="7"
        android:targetSdkVersion="11"/>

    <uses-permission android:name="android.permission.INTERNET"/>

    <application
        android:icon="@drawable/ic_launcher"
        android:label="@string/app_name">
        <uses-library android:name="com.google.android.maps"/>

        <activity
            android:name=".NooYawk"
            android:label="@string/app_name">
            <intent-filter>
                <action android:name="android.intent.action.MAIN"/>

                <category android:name="android.intent.category.LAUNCHER"/>
            </intent-filter>
        </activity>
    </application>
</manifest>
```

That is pretty much all you need for starters, plus to subclass your activity from `MapActivity`. If you were to do nothing else, and built that project and tossed it in

the emulator, you'd get a nice map of the world. Note, however, that `MapActivity` is abstract — you need to implement `isRouteDisplayed()` to indicate if you are supplying some sort of driving directions or not. Since displaying driving directions is not supported by the current edition of the terms of service, you should have `isRouteDisplayed()` return `false`.

### Optional Maps

Not every Android device will have Google Maps, because they did not elect to license it from Google. While most mainstream devices will have Google Maps, a few percent of Android devices will be without it.

You need to decide if having Google Maps is essential for your application's operation, or not.

If it is, the `<uses-library>` element shown above is the right answer, as that will require any device running your app to have Google Maps.

If, however, you want Google Maps to be optional, there is an `android:required` attribute available on `<uses-library>`. Set that to `false`, and then Google Maps will be loaded into your application if it is available, but your application will run regardless. You will then need to use something like `Class.forName("com.google.android.maps.MapView")` to see if Google Maps is available to you. If it is not, you can disable the menu items or whatever would lead the user to your `MapActivity`.

### Exercising Your Control

You can find your `MapView` widget by `findViewById()`, no different than any other widget. The widget itself then offers a `getController()` method. Between the `MapView` and `MapController`, you have a fair bit of capability to determine what the map shows and how it behaves. Here are some likely features you will want to use:

#### Zoom

The map of the world you start with is rather broad. Usually, people looking at a map on a phone will be expecting something a bit narrower in scope, such as a few city blocks.

You can control the zoom level directly via the `setZoom()` method on the `MapController`. This takes an integer representing the level of zoom, where 1 is the world view and 21 is the tightest zoom you can get. Each level is a doubling of the effective resolution: 1 has the equator measuring 256 pixels wide, while 21 has the equator measuring 268,435,456 pixels wide. Since the phone's display probably does not have 268,435,456 pixels in either dimension, the user sees a small map focused on one tiny corner of the globe. A level of 17 will show you several city blocks in each dimension and is probably a reasonable starting point for you to experiment with.

If you wish to allow users to change the zoom level, call `setBuiltInZoomControls(true);`, and the user will be able to zoom in and out of the map via zoom controls found in the bottom center of the map.

### Center

Typically, you will need to control what the map is showing, beyond the zoom level, such as the user's current location, or a location saved with some data in your activity. To change the map's position, call `setCenter()` on the `MapController`.

This takes a `GeoPoint` as a parameter. A `GeoPoint` represents a location, via latitude and longitude. The catch is that the `GeoPoint` stores latitude and longitude as integers representing the actual latitude and longitude in microdegrees (degrees multiplied by 1E6). This saves a bit of memory versus storing a float or double, and it greatly speeds up some internal calculations Android needs to do to convert the `GeoPoint` into a map position. However, it does mean you have to remember to multiply the “real world” latitude and longitude by 1E6.

### Layers Upon Layers

If you have ever used the full-size edition of Google Maps, you are probably used to seeing things overlaid atop the map itself, such as “push-pins” indicating businesses near the location being searched. In map parlance — and, for that matter, in many serious graphic editors — the push-pins are on a separate layer than the map itself, and what you are seeing is the composition of the push-pin layer atop the map layer.

Android's mapping allows you to create layers as well, so you can mark up the maps as you need to based on user input and your application's purpose. For example, `NooYawk` uses a layer to show where select buildings are located in the island of Manhattan.

### Overlay Classes

Any overlay you want to add to your map needs to be implemented as a subclass of `Overlay`. There is an `ItemizedOverlay` subclass available if you are looking to add push-pins or the like; `ItemizedOverlay` simplifies this process.

To attach an overlay class to your map, just call `getOverlays()` on your `MapView` and `add()` your `Overlay` instance to it, as we do here with a custom `SitesOverlay`:

```
Drawable marker=getResources().getDrawable(R.drawable.marker);  
marker.setBounds(0, 0, marker.getIntrinsicWidth(),  
                marker.getIntrinsicHeight());  
map.getOverlays().add(new SitesOverlay(marker));
```

We will explain that `marker` in just a bit.

### Drawing the ItemizedOverlay

As the name suggests, `ItemizedOverlay` allows you to supply a list of points of interest to be displayed on the map — specifically, instances of `OverlayItem`. The overlay, then, handles much of the drawing logic for you. Here are the minimum steps to make this work:

1. First, override `ItemizedOverlay<OverlayItem>` as your own subclass (in this example, `SitesOverlay`)
2. In the constructor, build your roster of `OverlayItem` instances, and call `populate()` when they are ready for use by the overlay
3. Implement `size()` to return the number of items to be handled by the overlay
4. Override `createItem()` to return `OverlayItem` instances given an index
5. When you instantiate your `ItemizedOverlay` subclass, provide it with a `Drawable` that represents the default icon (e.g., push-pin) to display for each item, on which you call `boundCenterBottom()` to enable the drop-shadow effect

The `marker` from the `NooYawk` constructor is the `Drawable` used for the last bullet above — it shows a push-pin.

For example, here is `SitesOverlay`:

```
private class SitesOverlay extends ItemizedOverlay<OverlayItem> {
    private List<OverlayItem> items=new ArrayList<OverlayItem>();

    public SitesOverlay(Drawable marker) {
        super(marker);

        boundCenterBottom(marker);

        items.add(new OverlayItem(getPoint(40.748963847316034,
            -73.96807193756104),
            "UN", "United Nations"));
        items.add(new OverlayItem(getPoint(40.76866299974387,
            -73.98268461227417),
            "Lincoln Center",
            "Home of Jazz at Lincoln Center"));
        items.add(new OverlayItem(getPoint(40.765136435316755,
            -73.97989511489868),
            "Carnegie Hall",
            "Where you go with practice, practice, practice"));
        items.add(new OverlayItem(getPoint(40.70686417491799,
            -74.01572942733765),
            "The Downtown Club",
            "Original home of the Heisman Trophy"));

        populate();
    }

    @Override
    protected OverlayItem createItem(int i) {
        return(items.get(i));
    }

    @Override
    protected boolean onTap(int i) {
        Toast.makeText(NooYawk.this,
            items.get(i).getSnippet(),
            Toast.LENGTH_SHORT).show();

        return(true);
    }

    @Override
    public int size() {
        return(items.size());
    }
}
```

### Handling Screen Taps

An `Overlay` subclass can also implement `onTap()`, to be notified when the user taps on the map, so the overlay can adjust what it draws. For example, in full-size Google

Maps, clicking on a push-pin pops up a bubble with information about the business at that pin's location. With `onTap()`, you can do much the same in Android.

The `onTap()` method for `ItemizedOverlay` receives the index of the `OverlayItem` that was clicked. It is up to you to do something worthwhile with this event.

In the case of `SitesOverlay`, we just toss up a short `Toast` with the “snippet” from the `OverlayItem`, returning `true` to indicate we handled the tap.

## My, Myself, and MyLocationOverlay

Android has a built-in overlay to handle two common scenarios:

- Showing where you are on the map, based on GPS or other location-providing logic
- Showing where you are pointed, based on the built-in compass sensor, where available

All you need to do is create a `MyLocationOverlay` instance, add it to your `MapView`'s list of overlays, and enable and disable the desired features at appropriate times.

The “at appropriate times” notion is for maximizing battery life. There is no sense in updating locations or directions when the activity is paused, so it is recommended that you enable these features in `onResume()` and disable them in `onPause()`.

For example, `NooYawk` will display a compass rose using `MyLocationOverlay`. To do this, we first need to create the overlay and add it to the list of overlays:

```
me=new MyLocationOverlay(this, map);
map.getOverlays().add(me);
```

(where `me` is the `MyLocationOverlay` instance as a private data member)

Then, we enable and disable the compass rose as appropriate:

```
@Override
public void onResume() {
    super.onResume();

    me.enableCompass();
}

@Override
```

## MAPPING WITH THE LEGACY MAPVIEW

---

```
public void onPause() {  
    super.onPause();  
  
    me.disableCompass();  
}
```

This gives us a compass rose while the activity is on-screen:

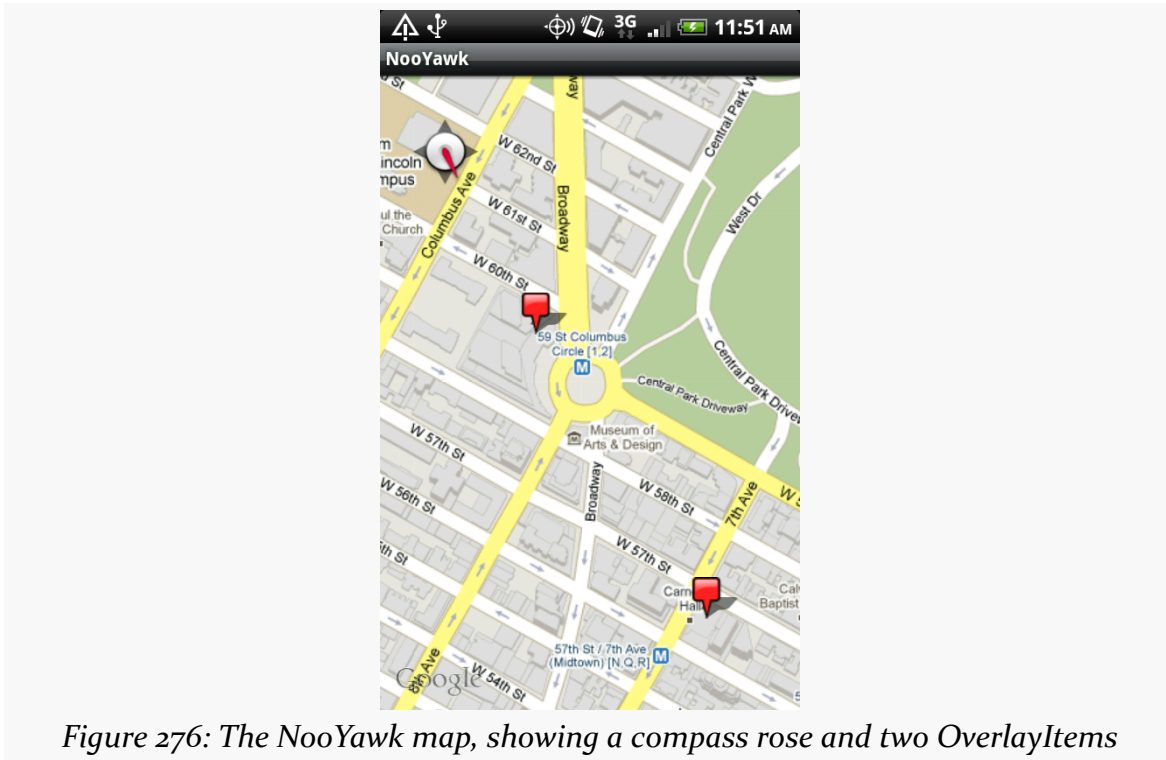


Figure 276: The NooYawk map, showing a compass rose and two OverlayItems

To show your location, you would use `enableMyLocation()` and `disableMyLocation()`. This will also require that you request an appropriate permission, such as `ACCESS_FINE_LOCATION`.

## Rugged Terrain

Just as the Google Maps you use on your full-size computer can display satellite imagery, so too can Android maps.

MapView offers `setSatellite()`, which toggles on and off this tile set on the area being viewed. You can have the user trigger these via an options menu or, in the case of NooYawk, via keypresses:



## MAPPING WITH THE LEGACY MAPVIEW

```
@Override
public boolean onKeyDown(int keyCode, KeyEvent event) {
    if (keyCode == KeyEvent.KEYCODE_S) {
        map.setSatellite(!map.isSatellite());
        return(true);
    }
    else if (keyCode == KeyEvent.KEYCODE_Z) {
        map.displayZoomControls(true);
        return(true);
    }
}

return(super.onKeyDown(keyCode, event));
}
```

So, for example, here is NooYawk showing a satellite view, courtesy of pressing the S key:

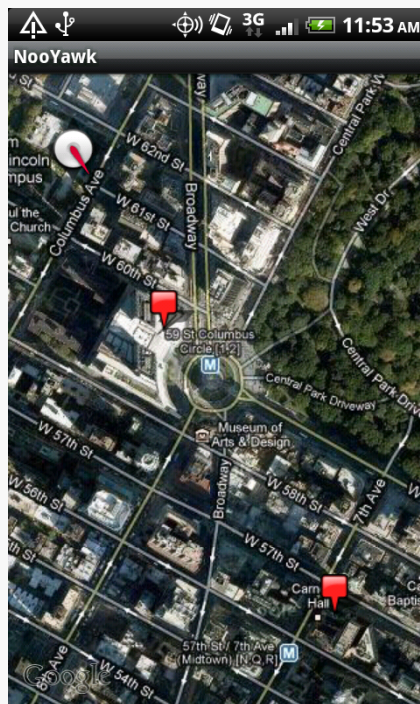


Figure 277: The NooYawk map, showing a compass rose and two OverlayItems, overlaid on the satellite view

# Maps and Fragments

You might think that maps would be an ideal place to use fragments. After all, on a large tablet screen, we could allocate most of the space to the map but then have other stuff alongside.

Alas, as of the time of this writing, maps and fragments are two great tastes that do not taste so great together.

First, MapView requires you to inherit from MapActivity. This has a few ramifications:

1. You cannot use the Android Support package, because that requires you to inherit from FragmentActivity, and Java does not support multiple inheritance. Hence, you can only use maps-in-fragments on Android 3.0 and higher, falling back to some alternative implementation on older versions of Android.
2. Any activity that might host a map in a fragment will have to inherit from MapActivity, even if in some cases it might not host a map in a fragment.

Also, MapView makes some assumptions about the timing of various events, in a fashion that makes setting up a map-based fragment a bit more complex than it might otherwise have to be.

It is entirely possible that someday these problems will be resolved, through a combination of an updated Google APIs Add-On for Android with fragment support, and possibly an updated Android Support package. In the meantime, here is the recipe for getting maps to work, as well as they can, in fragments.

## Limit Yourself to Android 3.0

In the manifest, make sure that you set both your `android:minSdkVersion` and your `android:targetSdkVersion` to 11, so you only run on Android 3.0 and newer. For example, here is the manifest from the Maps/NooYawkFragments sample project:

```
<?xml version="1.0" encoding="utf-8"?>
<manifest xmlns:android="http://schemas.android.com/apk/res/android"
    package="com.commonware.android.mapfrags">

    <uses-sdk
        android:minSdkVersion="11"
        android:targetSdkVersion="14"/>
```

```
<supports-screens
  android:largeScreens="true"
  android:normalScreens="true"
  android:smallScreens="true"/>

<uses-permission android:name="android.permission.INTERNET"/>

<application
  android:hardwareAccelerated="true"
  android:icon="@drawable/ic_launcher"
  android:label="@string/app_name"
  android:theme="@style/Theme.Sherlock">
  <uses-library android:name="com.google.android.maps"/>

  <activity
    android:name=".NooYawk"
    android:label="@string/app_name">
    <intent-filter>
      <action android:name="android.intent.action.MAIN"/>

      <category android:name="android.intent.category.LAUNCHER"/>
    </intent-filter>
  </activity>
</application>

</manifest>
```

### Use onCreateView() and onActivityCreated()

A map-based fragment is simply a Fragment that shows a MapView. By and large, this code can look and work much like a MapActivity would, configuring the MapView, setting up an ItemizedOverlay, and so on.

However, there is that timing problem.

The timing problem is that you cannot reliably return a MapView widget, or an inflated layout containing such a widget, from onCreateView(). For whatever reason, it works fine the first time, but on a configuration change (e.g., screen rotation) it fails.

The solution is to return a container from onCreateView(), such as a FrameLayout, as shown here in the MapFragment class from the [Maps/NooYawkFragments](#) sample project:

```
@Override
public View onCreateView(LayoutInflater inflater,
                        ViewGroup container,
```

## MAPPING WITH THE LEGACY MAPVIEW

---

```
        Bundle savedInstanceState) {
    setHasOptionsMenu(true);

    return(new FrameLayout(getActivity()));
}
```

Then, in `onActivityCreated()` — once `onCreate()` has been completed in the hosting `MapActivity` — you can add a `MapView` to that container and continue with the rest of your normal setup:

```
@Override
public void onActivityCreated(Bundle savedInstanceState) {
    super.onActivityCreated(savedInstanceState);

    map=
        new MapView(getActivity(),
                    "0mj160ufrY-tHs6WFurtL7rsYyEMpdEqBCbyjXg");
    map.setClickable(true);

    map.getController().setCenter(getPoint(40.76793169992044,
                                           -73.98180484771729));

    map.getController().setZoom(17);
    map.setBuiltInZoomControls(true);

    map.getOverlays().add(new SitesOverlay());

    me=new MyLocationOverlay(getActivity(), map);
    map.getOverlays().add(me);

    ((ViewGroup)getView()).addView(map);
}
```

Note that we are creating a `MapView` in Java code, which means our Maps API key resides in the Java code (or something reachable from the Java code, such as a string resource). You could inflate a layout containing a `MapView` here if you wished — the change for `MapFragment` was simply to illustrate creating a `MapView` from Java code.

### Host the Fragment in a MapActivity

You must make sure that whatever activity hosts the map-enabled fragment is a `MapActivity`. So, even though the `NooYawk` activity no longer has much to do with mapping, it must still be a `MapActivity`:

```
package com.commonware.android.mapfrags;

import android.os.Bundle;
import com.actionbarsherlock.app.SherlockMapActivity;

public class NooYawk extends SherlockMapActivity {
```

## MAPPING WITH THE LEGACY MAPVIEW

---

```
@Override
public void onCreate(Bundle savedInstanceState) {
    super.onCreate(savedInstanceState);
    setContentView(R.layout.main);
}

@Override
protected boolean isRouteDisplayed() {
    return(false);
}
}
```

The layout now points to a <fragment> instead of a MapView:

```
<?xml version="1.0" encoding="utf-8"?>
<fragment xmlns:android="http://schemas.android.com/apk/res/android"
    android:name="com.commonware.android.mapfrags.MapFragment"
    android:id="@+id/map_fragment"
    android:layout_width="fill_parent"
    android:layout_height="fill_parent"
/>
```

The resulting application looks like the original NooYawk activity would on a large screen, because we are not doing anything much else with the fragment system (e.g., having other fragments alongside in a landscape layout):

## MAPPING WITH THE LEGACY MAPVIEW

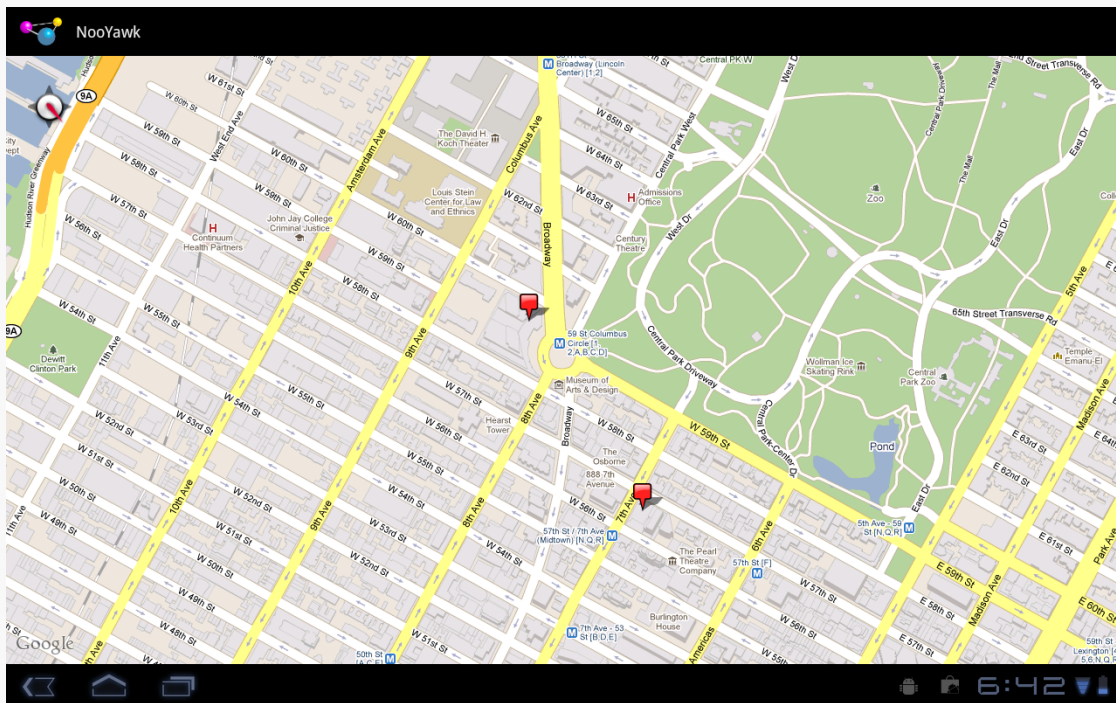


Figure 278: The NooYawkFragments map, rendered on a Motorola XOOM

## Get to the Point

By default, it appears that, when the user taps on one of your `OverlayItem` icons in an `ItemizedOverlay`, all you find out is which `OverlayItem` it is, courtesy of an index into your collection of items. However, Android does provide means to find out where that item is, both in real space and on the screen.

## Getting the Latitude and Longitude

You supplied the latitude and longitude — in the form of a `GeoPoint` — when you created the `OverlayItem` in the first place. Not surprisingly, you can get that back via a `getPoint()` method on `OverlayItem`. So, in an `onTap()` method, you can do this to get the `GeoPoint`:

```
@Override
protected boolean onTap(int i) {
    OverlayItem item=getItem(i);
    GeoPoint geo=item.getPoint();

    // other good stuff here
```

```
return(true);  
}
```

### Getting the Screen Position

If you wanted to find the screen coordinates for that `GeoPoint`, you might be tempted to find out where the map is centered (via `getCenter()` on `MapView`) and how big the map is in terms of screen size (`getWidth()`, `getHeight()` on `MapView`) and geographic area (`getLatitudeSpan()`, `getLongitudeSpan()` on `MapView`), and do all sorts of calculations.

Good news! You do not have to do any of that.

Instead, you can get a `Projection` object from the `MapView` via `getProjection()`. This object can do the conversions for you, such as `toPixels()` to convert a `GeoPoint` into a screen `Point` for the X/Y position.

For example, take a look at the `onTap()` implementation from the `NooYawk` class in the [Maps/NooYawkRedux](#) sample project:

Here, we get the `GeoPoint` (as in the previous section), get the `Point` (via `toPixels()`), and use those to customize a message for use with our `Toast`.

Note that our `Toast` message has an embedded newline (`\n`), so it is split over two lines:

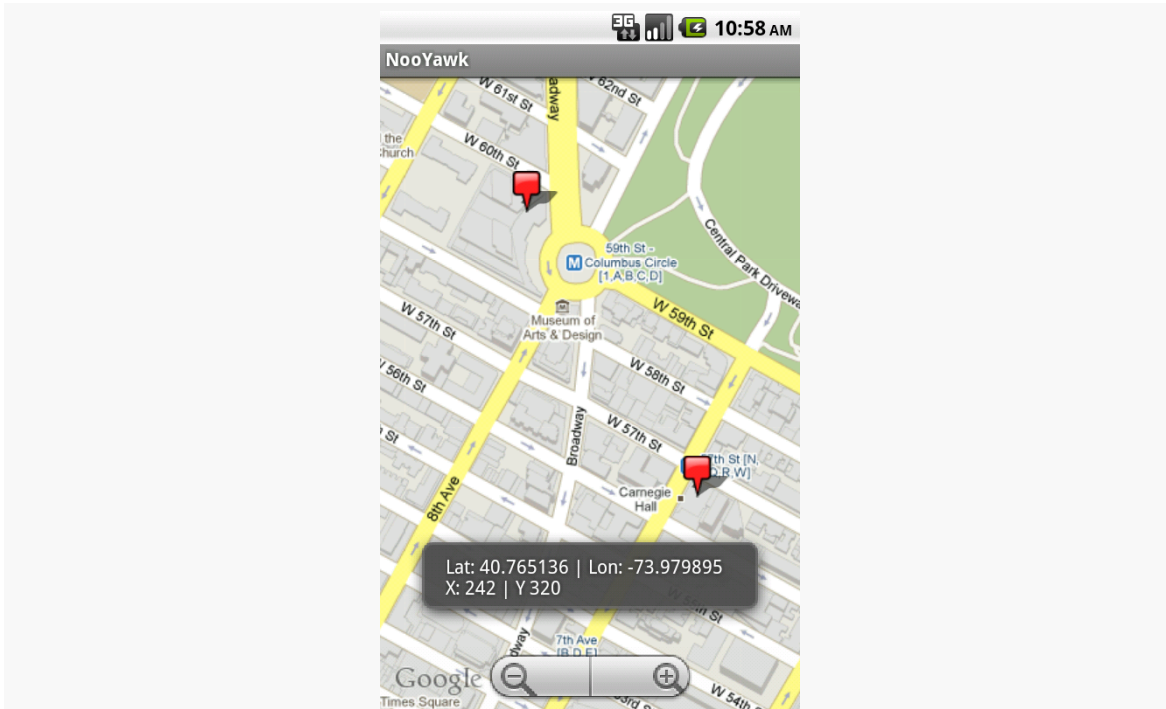


Figure 279: The NooYawkRedux application, showing the Toast with GeoPoint and Point data

## Not-So-Tiny Bubbles

Of course, just because somebody taps on an item in your `ItemizedOverlay`, nothing really happens, other than letting you know of the tap. If you want something visual to occur — like the Toast displayed in the Maps/NooYawkRedux project — you have to do it yourself. And while a Toast is easy to implement, it tends not to be terribly useful in many cases.

A more likely reaction is to pop up some sort of bubble or panel on the screen, providing more details about the item that was tapped upon. That bubble might be display-only or fully interactive, perhaps leading to another activity for information beyond what the panel can hold.

While the techniques in this section will be couched in terms of pop-up panels over a `MapView`, the same basic concepts can be used just about anywhere in Android.



### Options for Pop-up Panels

A pop-up panel is simply a View (typically a ViewGroup with contents, like a RelativeLayout containing widgets) that appears over the MapView on demand. To make one View appear over another, you need to use a common container that supports that sort of “Z-axis” ordering. The best one for that is RelativeLayout: children later in the roster of children of the RelativeLayout will appear over top of children that are earlier in the roster. So, if you have a RelativeLayout parent, with a full-screen MapView child followed by another ViewGroup child, that latter ViewGroup will appear to float over the MapView. In fact, with the use of a translucent background, you can even see the map peeking through the ViewGroup.

Given that, here are two main strategies for implementing pop-up panels.

One approach is to have the panel be part of the activity’s layout from the beginning, but use a visibility of GONE to have it not be visible. In this case, you would define the panel in the main layout XML file, set `android:visibility="gone"`, and use `setVisibility()` on that panel at runtime to hide and show it. This works well, particularly if the panel itself is not changing much, just becoming visible and gone.

The other approach is to inflate the panel at runtime and dynamically add and remove it as a child of the RelativeLayout. This works well if there are many possible panels, perhaps dependent on the type of thing represented by an OverlayItem (e.g., restaurant versus hotel versus used car dealership).

In this section, we will examine the latter approach, as shown in the [Maps/EvenNooerYawk](#) sample project.

### Defining a Panel Layout

The new version of NooYawk is designed to display panels when the user taps on items in the map, replacing the original Toast.

To do this, first, we need the actual content of a panel, as found in `res/layout/popup.xml`:

```
<?xml version="1.0" encoding="utf-8"?>
<TableLayout xmlns:android="http://schemas.android.com/apk/res/android"
    android:layout_width="match_parent"
    android:layout_height="match_parent"
    android:stretchColumns="1,3"
    android:background="@drawable/popup_frame">
```

```
<TableRow>
  <TextView
    android:text="Lat:"
    android:layout_marginRight="10dip"
  />
  <TextView android:id="@+id/latitude" />
  <TextView
    android:text="Lon:"
    android:layout_marginRight="10dip"
  />
  <TextView android:id="@+id/longitude" />
</TableRow>
<TableRow>
  <TextView
    android:text="X:"
    android:layout_marginRight="10dip"
  />
  <TextView android:id="@+id/x" />
  <TextView
    android:text="Y:"
    android:layout_marginRight="10dip"
  />
  <TextView android:id="@+id/y"/>
</TableRow>
</TableLayout>
```

Here, we have a `TableLayout` containing our four pieces of data (latitude, longitude, X, and Y), with a translucent gray background (courtesy of a [nine-patch graphic image](#)).

The intent is that we will inflate instances of this class when needed. And, as we will see, we will only need one in this example, though it is possible that other applications might need more.

### Creating a `PopupPanel` Class

To manage our panel, `NooYawk` has an inner class named `PopupPanel`. It takes the resource ID of the layout as a parameter, so it could be used to manage several different types of panels, not just the one we are using here.

Its constructor inflates the layout file (using the map's parent – the `RelativeLayout` — as the basis for inflation rules) and also hooks up a click listener to a `hide()` method (described below):

```
PopupPanel(int layout) {
    ViewGroup parent=(ViewGroup)map.getParent();

    popup=getLayoutInflater().inflate(layout, parent, false);
```

```
popup.setOnClickListener(new View.OnClickListener() {
    public void onClick(View v) {
        hide();
    }
});
}
```

PopupPanel also tracks an isVisible data member, reflecting whether or not the panel is presently on the screen.

### Showing and Hiding the Panel

When it comes time to show the panel, either it is already being shown, or it is not. The former would occur if the user tapped on one item in the overlay, then tapped another right away. The latter would occur, for example, for the first tap.

In either case, we need to determine where to position the panel. Having the panel obscure what was tapped upon would be poor form. So, PopupPanel will put the panel either towards the top or bottom of the map, depending on where the user tapped — if they tapped in the top half of the map, the panel will go on the bottom. Rather than have the panel abut the edges of the map directly, PopupPanel also adds some margins — this is also important for making sure the panel and the Google logo on the map do not interfere.

If the panel is visible, PopupPanel calls hide() to remove it, then adds the panel's View as a child of the RelativeLayout with a RelativeLayout.LayoutParams that incorporates the aforementioned rules:

```
void show(boolean alignTop) {
    RelativeLayout.LayoutParams lp=new RelativeLayout.LayoutParams(
        RelativeLayout.LayoutParams.WRAP_CONTENT,
        RelativeLayout.LayoutParams.WRAP_CONTENT
    );

    if (alignTop) {
        lp.addRule(RelativeLayout.ALIGN_PARENT_TOP);
        lp.setMargins(0, 20, 0, 0);
    }
    else {
        lp.addRule(RelativeLayout.ALIGN_PARENT_BOTTOM);
        lp.setMargins(0, 0, 0, 60);
    }

    hide();

    ((ViewGroup)map.getParent()).addView(popup, lp);
}
```

```
    isVisible=true;
}
```

The `hide()` method, in turn, removes the panel from the `RelativeLayout`:

```
void hide() {
    if (isVisible) {
        isVisible=false;
        ((ViewGroup)popup.getParent()).removeView(popup);
    }
}
```

`PopupPanel` also has a `getView()` method, so the overlay can get at the panel `View` in order to fill in the pieces of data at runtime:

```
View getView() {
    return(popup);
}
```

### Tying It Into the Overlay

To use the panel, `NooYawk` creates an instance of one as a data member of the `ItemizedOverlay` class. Then, in the new `onTap()` method, the overlay gets the `View`, populates it, and shows it, indicating whether it should appear towards the top or bottom of the screen:

```
private class SitesOverlay extends ItemizedOverlay<OverlayItem> {
    private List<OverlayItem> items=new ArrayList<OverlayItem>();
    private Drawable marker=null;
    private PopupPanel panel=new PopupPanel(R.layout.popup);

    public SitesOverlay(Drawable marker) {
        super(marker);
        this.marker=marker;

        items.add(new OverlayItem(getPoint(40.748963847316034,
            -73.96807193756104),
            "UN", "United Nations"));
        items.add(new OverlayItem(getPoint(40.76866299974387,
            -73.98268461227417),
            "Lincoln Center",
            "Home of Jazz at Lincoln Center"));
        items.add(new OverlayItem(getPoint(40.765136435316755,
            -73.97989511489868),
            "Carnegie Hall",
            "Where you go with practice, practice, practice"));
        items.add(new OverlayItem(getPoint(40.70686417491799,
            -74.01572942733765),
            "The Downtown Club",
```

## MAPPING WITH THE LEGACY MAPVIEW

---

```
        "Original home of the Heisman Trophy"));

    populate();
}

@Override
protected OverlayItem createItem(int i) {
    return(items.get(i));
}

@Override
public void draw(Canvas canvas, MapView mapView,
                 boolean shadow) {
    super.draw(canvas, mapView, shadow);

    boundCenterBottom(marker);
}

@Override
protected boolean onTap(int i) {
    OverlayItem item=getItem(i);
    GeoPoint geo=item.getPoint();
    Point pt=map.getProjection().toPixels(geo, null);

    View view=panel.getView();

    ((TextView)view.findViewById(R.id.latitude))
        .setText(String.valueOf(geo.getLatitudeE6()/1000000.0));
    ((TextView)view.findViewById(R.id.longitude))
        .setText(String.valueOf(geo.getLongitudeE6()/1000000.0));
    ((TextView)view.findViewById(R.id.x))
        .setText(String.valueOf(pt.x));
    ((TextView)view.findViewById(R.id.y))
        .setText(String.valueOf(pt.y));

    panel.show(pt.y*2>map.getHeight());

    return(true);
}

@Override
public int size() {
    return(items.size());
}
}
```

Here is the complete implementation of NooYawk from Maps/EvenNooerYawk, including the revised overlay class and the new PopupPanel class:

```
package com.commonware.android.nooer;

import java.util.ArrayList;
import java.util.List;
```

## MAPPING WITH THE LEGACY MAPVIEW

---

```
import android.graphics.Canvas;
import android.graphics.Point;
import android.graphics.drawable.Drawable;
import android.os.Bundle;
import android.view.KeyEvent;
import android.view.View;
import android.view.ViewGroup;
import android.widget.RelativeLayout;
import android.widget.TextView;
import com.google.android.maps.GeoPoint;
import com.google.android.maps.ItemizedOverlay;
import com.google.android.maps.MapActivity;
import com.google.android.maps.MapView;
import com.google.android.maps.MyLocationOverlay;
import com.google.android.maps.OverlayItem;

public class NooYawk extends MapActivity {
    private MapView map=null;
    private MyLocationOverlay me=null;

    @Override
    public void onCreate(Bundle savedInstanceState) {
        super.onCreate(savedInstanceState);
        setContentView(R.layout.main);

        map=(MapView)findViewById(R.id.map);

        map.getController().setCenter(getPoint(40.76793169992044,
                                                -73.98180484771729));

        map.getController().setZoom(17);
        map.setBuiltInZoomControls(true);

        Drawable marker=getResources().getDrawable(R.drawable.marker);

        marker.setBounds(0, 0, marker.getIntrinsicWidth(),
                        marker.getIntrinsicHeight());

        map.getOverlays().add(new SitesOverlay(marker));

        me=new MyLocationOverlay(this, map);
        map.getOverlays().add(me);
    }

    @Override
    public void onResume() {
        super.onResume();

        me.enableCompass();
    }

    @Override
    public void onPause() {
        super.onPause();
    }
}
```

## MAPPING WITH THE LEGACY MAPVIEW

---

```
me.disableCompass();
}

@Override
protected boolean isRouteDisplayed() {
    return(false);
}

@Override
public boolean onKeyDown(int keyCode, KeyEvent event) {
    if (keyCode == KeyEvent.KEYCODE_S) {
        map.setSatellite(!map.isSatellite());
        return(true);
    }
    else if (keyCode == KeyEvent.KEYCODE_Z) {
        map.displayZoomControls(true);
        return(true);
    }

    return(super.onKeyDown(keyCode, event));
}

private GeoPoint getPoint(double lat, double lon) {
    return(new GeoPoint((int)(lat*1000000.0),
        (int)(lon*1000000.0)));
}

private class SitesOverlay extends ItemizedOverlay<OverlayItem> {
    private List<OverlayItem> items=new ArrayList<OverlayItem>();
    private Drawable marker=null;
    private PopupPanel panel=new PopupPanel(R.layout.popup);

    public SitesOverlay(Drawable marker) {
        super(marker);
        this.marker=marker;

        items.add(new OverlayItem(getPoint(40.748963847316034,
            -73.96807193756104),
            "UN", "United Nations"));
        items.add(new OverlayItem(getPoint(40.76866299974387,
            -73.98268461227417),
            "Lincoln Center",
            "Home of Jazz at Lincoln Center"));
        items.add(new OverlayItem(getPoint(40.765136435316755,
            -73.97989511489868),
            "Carnegie Hall",
            "Where you go with practice, practice, practice"));
        items.add(new OverlayItem(getPoint(40.70686417491799,
            -74.01572942733765),
            "The Downtown Club",
            "Original home of the Heisman Trophy"));

        populate();
    }
}
```

## MAPPING WITH THE LEGACY MAPVIEW

---

```
@Override
protected OverlayItem createItem(int i) {
    return(items.get(i));
}

@Override
public void draw(Canvas canvas, MapView mapView,
                 boolean shadow) {
    super.draw(canvas, mapView, shadow);

    boundCenterBottom(marker);
}

@Override
protected boolean onTap(int i) {
    OverlayItem item=getItem(i);
    GeoPoint geo=item.getPoint();
    Point pt=map.getProjection().toPixels(geo, null);

    View view=panel.getView();

    ((TextView)view.findViewById(R.id.latitude))
        .setText(String.valueOf(geo.getLatitudeE6()/1000000.0));
    ((TextView)view.findViewById(R.id.longitude))
        .setText(String.valueOf(geo.getLongitudeE6()/1000000.0));
    ((TextView)view.findViewById(R.id.x))
        .setText(String.valueOf(pt.x));
    ((TextView)view.findViewById(R.id.y))
        .setText(String.valueOf(pt.y));

    panel.show(pt.y*2>map.getHeight());

    return(true);
}

@Override
public int size() {
    return(items.size());
}
}

class PopupPanel {
    View popup;
    boolean isVisible=false;

    PopupPanel(int layout) {
        ViewGroup parent=(ViewGroup)map.getParent();

        popup=getLayoutInflater().inflate(layout, parent, false);

        popup.setOnClickListener(new View.OnClickListener() {
            public void onClick(View v) {
                hide();
            }
        });
    }
}
```



## MAPPING WITH THE LEGACY MAPVIEW

---

```
    }
  });
}

View getView() {
    return(popup);
}

void show(boolean alignTop) {
    RelativeLayout.LayoutParams lp=new RelativeLayout.LayoutParams(
        RelativeLayout.LayoutParams.WRAP_CONTENT,
        RelativeLayout.LayoutParams.WRAP_CONTENT
    );

    if (alignTop) {
        lp.addRule(RelativeLayout.ALIGN_PARENT_TOP);
        lp.setMargins(0, 20, 0, 0);
    }
    else {
        lp.addRule(RelativeLayout.ALIGN_PARENT_BOTTOM);
        lp.setMargins(0, 0, 0, 60);
    }

    hide();

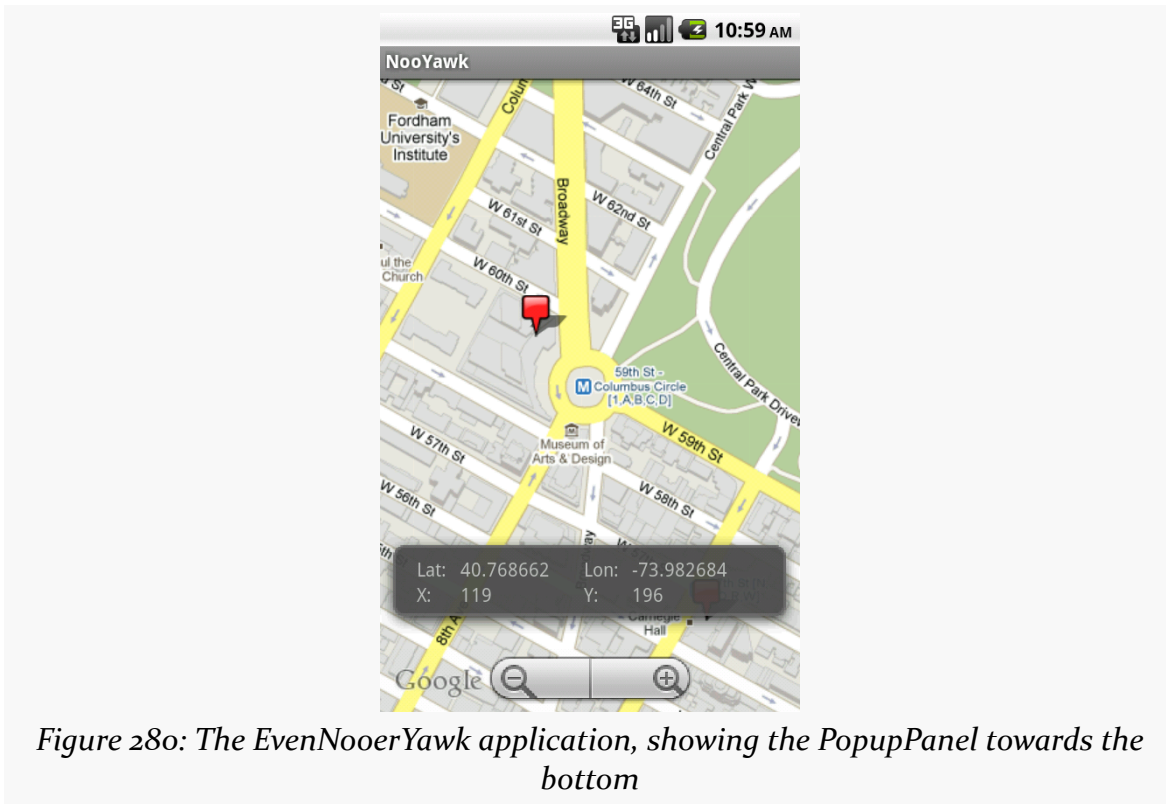
    ((ViewGroup)map.getParent()).addView(popup, lp);
    isVisible=true;
}

void hide() {
    if (isVisible) {
        isVisible=false;
        ((ViewGroup)popup.getParent()).removeView(popup);
    }
}
}
```

The resulting panel looks like this when it is towards the bottom of the screen:

## MAPPING WITH THE LEGACY MAPVIEW

---



*Figure 280: The EvenNoorYawk application, showing the PopupPanel towards the bottom*

... and like this when it is towards the top:

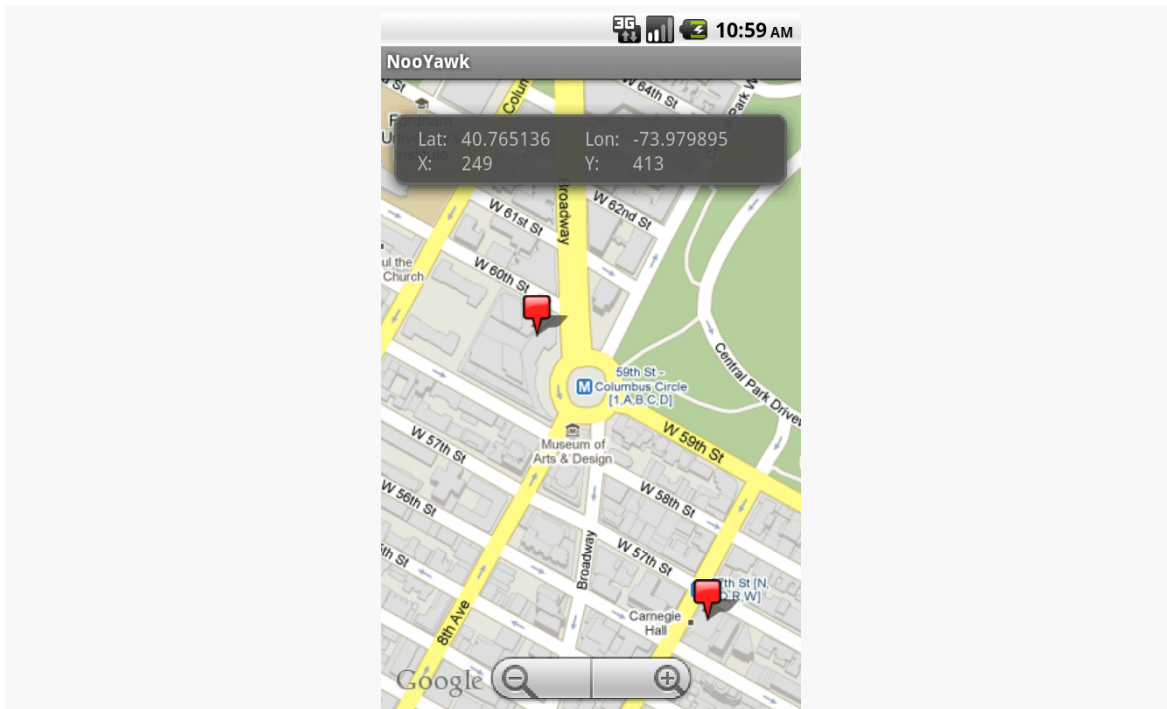


Figure 281: The EvenNooerYawk application, showing the *PopupPanel* towards the top

## Sign, Sign, Everywhere a Sign

Our examples for Manhattan have treated each of the four locations as being the same — they are all represented by the same sort of marker. That is the natural approach to creating an *ItemizedOverlay*, since it takes the marker *Drawable* as a constructor parameter.

It is not the only option, though.

### Selected States

One flaw in our current one-*Drawable*-for-everyone approach is that you cannot tell which item was selected by the user, either by tapping on it or by using the D-pad (or trackball or whatever). A simple PNG icon will look the same as it will in every other state.

However, in the [chapter on Drawable techniques](#), we saw the *StateListDrawable* and its accompanying XML resource format. We can use one of those here, to specify a separate icon for selected and regular states.

In the [Maps/ILuvNooYawk](#) sample project, we change up the icons used for our four `OverlayItem` objects. Specifically, in the next section, we will see how to associate a distinct `Drawable` for each item. Those `Drawable` resources will actually be `StateListDrawable` objects, using XML such as:

```
<selector xmlns:android="http://schemas.android.com/apk/res/android">
  <item
    android:state_selected="true"
    android:drawable="@drawable/blue_sel_marker"
  />
  <item
    android:drawable="@drawable/blue_marker"
  />
</selector>
```

This indicates that we should use one PNG in the default state and a different PNG (one with a yellow highlight) when the `OverlayItem` is selected.

### Per-Item Drawables

To use a different `Drawable` per `OverlayItem`, we need to create a custom `OverlayItem` class. Normally, you can skip this, and just use `OverlayItem` directly. But, `OverlayItem` has no means to change its `Drawable` used for the marker, so we have to extend it and override `getMarker()` to handle a custom `Drawable`.

Here is one possible implementation of a `CustomItem` class:

```
class CustomItem extends OverlayItem {
    Drawable marker=null;

    CustomItem(GeoPoint pt, String name, String snippet,
              Drawable marker) {
        super(pt, name, snippet);
        this.marker=marker;
    }

    @Override
    public Drawable getMarker(int stateBitset) {
        setState(marker, stateBitset);

        return(marker);
    }
}
```

This class takes the `Drawable` to use as a constructor parameter, holds onto it, and returns it in the `getMarker()` method. However, in `getMarker()`, we also need to call

## MAPPING WITH THE LEGACY MAPVIEW

---

setState() — if we are using StateListDrawable resources, the call to setState() will cause the Drawable to adopt the appropriate state (e.g., selected).

Of course, we need to prep and feed a Drawable to each of the CustomItem objects. In the case of ILuvNooYawk, when our SitesOverlay creates its items, it uses a getMarker() method to access each item's Drawable:

```
public SitesOverlay() {
    super(null);

    heart=getMarker(R.drawable.heart_full);

    items.add(new CustomItem(getPoint(40.748963847316034,
        -73.96807193756104),
        "UN", "United Nations",
        getMarker(R.drawable.blue_full_marker),
        heart));
    items.add(new CustomItem(getPoint(40.76866299974387,
        -73.98268461227417),
        "Lincoln Center",
        "Home of Jazz at Lincoln Center",
        getMarker(R.drawable.orange_full_marker),
        heart));
    items.add(new CustomItem(getPoint(40.765136435316755,
        -73.97989511489868),
        "Carnegie Hall",
        "Where you go with practice, practice, practice",
        getMarker(R.drawable.green_full_marker),
        heart));
    items.add(new CustomItem(getPoint(40.70686417491799,
        -74.01572942733765),
        "The Downtown Club",
        "Original home of the Heisman Trophy",
        getMarker(R.drawable.purple_full_marker),
        heart));

    populate();
}
```

Here, we get the Drawable resources, set its bounds (for use with hit testing on taps), and use boundCenter() to control the way the shadow falls. For icons like the original push pin used by NooYawk, boundCenterBottom() will cause the icon and its shadow to make it seem like the icon is rising up off the face of the map. For icons like ILuvNooYawk uses, boundCenter() will cause the icon and shadow to make it seem like the icon is hovering flat over top of the map.

## Changing Drawables Dynamically

It is also possible to change the Drawable used by an item at runtime, beyond simply changing it from normal to selected state. For example, `ILuvNooYawk` allows you to press the H key and toggle the selected item from its normal icon to a heart:

```
@Override
public boolean onKeyDown(int keyCode, KeyEvent event) {
    if (keyCode == KeyEvent.KEYCODE_S) {
        map.setSatellite(!map.isSatellite());
        return(true);
    }
    else if (keyCode == KeyEvent.KEYCODE_Z) {
        map.displayZoomControls(true);
        return(true);
    }
    else if (keyCode == KeyEvent.KEYCODE_H) {
        sites.toggleHeart();

        return(true);
    }
}

return(super.onKeyDown(keyCode, event));
}
```

To make this work, our `SitesOverlay` needs to implement `toggleHeart()`:

```
void toggleHeart() {
    CustomItem focus=getFocus();

    if (focus!=null) {
        focus.toggleHeart();
    }

    map.invalidate();
}
```

Here, we just find the selected item and delegate `toggleHeart()` to it. This, of course, assumes both that `CustomItem` has a `toggleHeart()` implementation and knows what heart to use.

So, rather than the simple `CustomItem` shown above, we need a more elaborate implementation:

```
class CustomItem extends OverlayItem {
    Drawable marker=null;
    boolean isHeart=false;
    Drawable heart=null;
}
```

## MAPPING WITH THE LEGACY MAPVIEW

---

```
CustomItem(GeoPoint pt, String name, String snippet,
           Drawable marker, Drawable heart) {
    super(pt, name, snippet);

    this.marker=marker;
    this.heart=heart;
}

@Override
public Drawable getMarker(int stateBitset) {
    Drawable result=(isHeart ? heart : marker);

    setState(result, stateBitset);

    return(result);
}

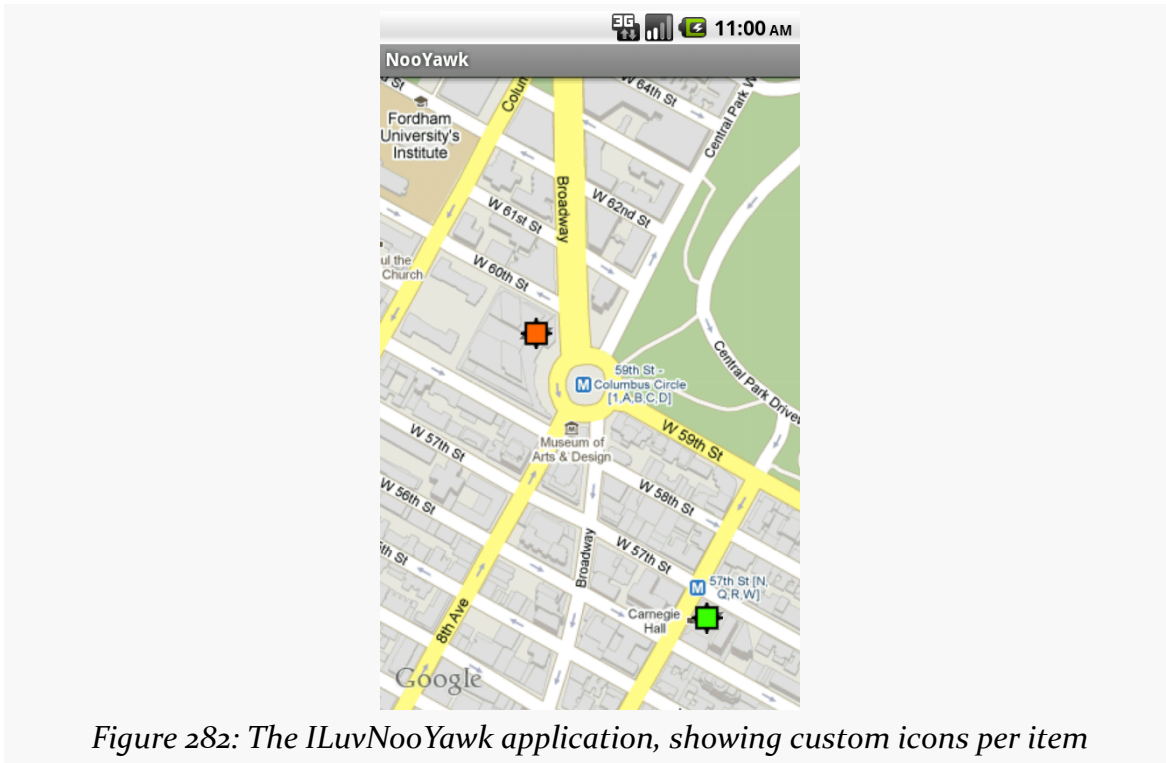
void toggleHeart() {
    isHeart=!isHeart;
}
}
```

Here, the CustomItem gets its own icon and the heart icon in the constructor, and toggleHeart() just toggles between them. The key is that we invalidate() the MapView in the SitesOverlay implementation of toggleHeart() — that causes the map, and its overlay items, to be redrawn, causing the icon Drawable to change on the screen.

This means that while we start with custom icons per item:

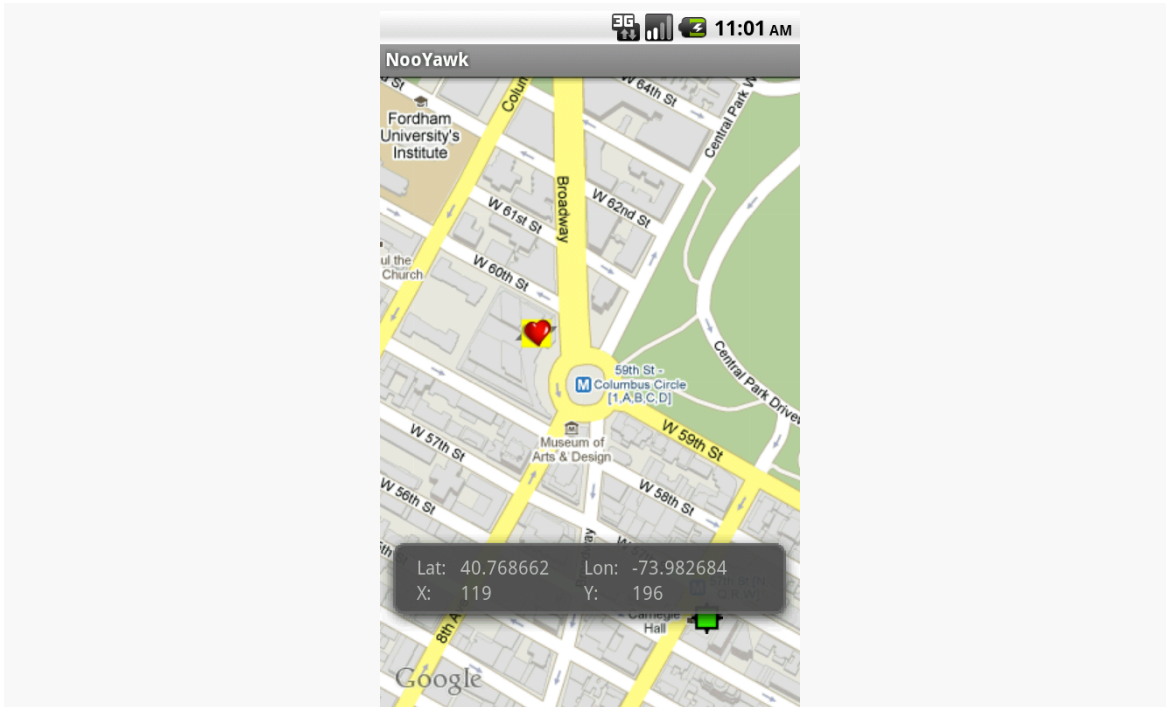
## MAPPING WITH THE LEGACY MAPVIEW

---



... we can change those by clicking on an item and pressing the H key:





*Figure 283: The ILuvNooYawk application, showing one item's icon toggled to a heart (and selected)*

Note that `getMarker()` on an `OverlayItem` gets called very frequently — every time the map is panned or zoomed, the markers are re-requested. As such, it is important that `getMarker()` be as efficient as possible, particularly if you have a lot of items in your overlay.

### **In A New York Minute. Or Hopefully a Bit Faster.**

In the case of *NooYawk*, we have all our data points for the overlay items up front — they are hard-wired into the code. This is not going to be the case in most applications. Instead, the application will need to load the items out of a database or a Web service.

In the case of a database, assuming a modest number of items, the difference between having the items hard-wired in code or in the database is slight. Yes, the actual implementation will be substantially different, but you can query the database and build up your `ItemizedOverlay` all in one shot, when the map is slated to appear on-screen.

## MAPPING WITH THE LEGACY MAPVIEW

---

Where things get interesting is when you need to use a Web service or similar slow operation to get the data.

Where things get even more interesting is when you want that data to change after it was already loaded — on a timer, on user input, etc. For example, it may be that you have hundreds of thousands of data points, only a tiny fraction of which will be visible on the map at any time. If the user elects to visit a different portion of the map, you need to dump the old overlay items and grab a new set.

In either case, you can use an AsyncTask to populate your ItemizedOverlay and add it to the map once the data is ready. You can see this in the [Maps/NooYawkAsync](#) sample project, where we kick off an OverlayTask in the NooYawk implementation of onCreate():

```
@Override
public void onCreate(Bundle savedInstanceState) {
    super.onCreate(savedInstanceState);
    setContentView(R.layout.main);

    map=(MapView)findViewById(R.id.map);

    map.getController().setCenter(getPoint(40.76793169992044,
                                           -73.98180484771729));

    map.getController().setZoom(17);
    map.setBuiltInZoomControls(true);

    me=new MyLocationOverlay(this, map);
    map.getOverlays().add(me);

    new OverlayTask().execute();
}
```

... and then use that to load the data in the background, in this case using a sleep() call to simulate real work:

```
class OverlayTask extends AsyncTask<Void, Void, Void> {
    @Override
    public void onPreExecute() {
        if (sites!=null) {
            map.getOverlays().remove(sites);
            map.invalidate();
            sites=null;
        }
    }

    @Override
    public Void doInBackground(Void... unused) {
        SystemClock.sleep(5000); // simulated work
    }
}
```

```
sites=new SitesOverlay();

return(null);
}

@Override
public void onPostExecute(Void unused) {
    map.getOverlays().add(sites);
    map.invalidate();
}
}
```

As with changing an item's Drawable on the fly, you need to `invalidate()` the map to make sure it draws the overlay and its items.

In this case, we also hook up the R key to simulate a manual refresh of the data. This just invokes another `OverlayTask`, which removes the old overlay and creates a fresh one:

```
@Override
public boolean onKeyDown(int keyCode, KeyEvent event) {
    if (keyCode == KeyEvent.KEYCODE_S) {
        map.setSatellite(!map.isSatellite());
        return(true);
    }
    else if (keyCode == KeyEvent.KEYCODE_Z) {
        map.displayZoomControls(true);
        return(true);
    }
    else if (keyCode == KeyEvent.KEYCODE_H) {
        sites.toggleHeart();

        return(true);
    }
    else if (keyCode == KeyEvent.KEYCODE_R) {
        new OverlayTask().execute();

        return(true);
    }

    return(super.onKeyDown(keyCode, event));
}
```

## A Little Touch of Noo Yawk

As all of these examples have demonstrated, users can tap on maps, particularly on `OverlayItem` icons, to indicate something of interest.

Sometimes, though, what they really want to do is move one of those items.

For example:

1. They might want to reposition an endpoint for a route for which you are providing turn-by-turn directions
2. They might want to fine-tune a waypoint on a set of walking or cycling tour stops they are designing using your app, adjusting its location by a bit
3. They might want to change the corner points on a polygon they are creating on your map, to designate postal zones or township boundaries or whatever

Courtesy of an assist from Greg Milette, we can show you how this is done, via the [Maps/NooYawkTouch](#) sample project.

### Touch Events

Simple touch events are... well... fairly simple.

In an `ItemizedOverlay`, you can override the `onTouchEvent()` method, to be notified of touch operations. Any event you pass to the superclass will be handled as normal, such as item taps or pan-and-zoom operations. However, you can intercept events that you would prefer to handle yourself. Your `onTouchEvent()` method will be passed a `MotionEvent` object (the actual event) and the `MapView`.

There are three touch events of relevance for repositioning items on a map, distinguished by their action (`getAction()` on the `MotionEvent`):

- `MotionEvent.ACTION_DOWN`, when a finger is placed onto the touchscreen
- `MotionEvent.ACTION_MOVE`, when the finger is slid across the touchscreen
- `MotionEvent.ACTION_UP`, when the finger is lifted off of the touchscreen

The `MotionEvent` also gives you the screen coordinates of where the touch event occurred, via `getX()` and `getY()`.

To manage a drag operation, therefore, we need to:

1. Watch for an `ACTION_DOWN` event, identify the item that was touched, and kick off the drag
2. Watch for `ACTION_MOVE` events while we are in “drag mode” and move the item to the new position
3. Watch for an `ACTION_UP` event and stop the drag operation, positioning the item in its final resting place

## MAPPING WITH THE LEGACY MAPVIEW

---

Here is the implementation of `onTouchEvent()` for the `NooYawkTouch` version of `SitesOverlay`:

```
@Override
public boolean onTouchEvent(MotionEvent event, MapView mapView) {
    final int action=event.getAction();
    final int x=(int)event.getX();
    final int y=(int)event.getY();
    boolean result=false;

    if (action==MotionEvent.ACTION_DOWN) {
        for (OverlayItem item : items) {
            Point p=new Point(0,0);

            mapView.getProjection().toPixels(item.getPoint(), p);

            if (hitTest(item, marker, x-p.x, y-p.y)) {
                result=true;
                inDrag=item;
                items.remove(inDrag);
                populate();

                xDragTouchOffset=0;
                yDragTouchOffset=0;

                setDragImagePosition(p.x, p.y);
                dragImage.setVisibility(View.VISIBLE);

                xDragTouchOffset=x-p.x;
                yDragTouchOffset=y-p.y;

                break;
            }
        }
    }
    else if (action==MotionEvent.ACTION_MOVE && inDrag!=null) {
        setDragImagePosition(x, y);
        result=true;
    }
    else if (action==MotionEvent.ACTION_UP && inDrag!=null) {
        dragImage.setVisibility(View.GONE);

        GeoPoint pt=mapView.getProjection().fromPixels(x-xDragTouchOffset,
                                                    y-yDragTouchOffset);
        OverlayItem toDrop=new OverlayItem(pt, inDrag.getTitle(),
                                           inDrag.getSnippet());

        items.add(toDrop);
        populate();

        inDrag=null;
        result=true;
    }
}
```

```
return(result || super.onTouchEvent(event, mapView));
}
```

We will look at the three major branches of this code in the sections that follow.

### Finding an Item

ItemizedOverlay offers a convenient `hitTest()` method, to determine if a touch event (or anything else with a screen coordinate) is “close” to a specific `OverlayItem`. The `hitTest()` method returns a simple boolean indicating if the touch event was a hit on the item. Hence, to find out if a given `ACTION_DOWN` event was on an item, we can simply iterate over all items, passing each to `hitTest()`, and breaking out of the loop if we get a hit. If we make it through the whole loop with `hitTest()` returning false each time, the user tapped someplace away from any items.

The only catch is that `hitTest()` works in the item’s frame of reference. Rather than passing a screen coordinate relative to the corner of the screen (as is returned by `getX()` and `getY()` on `MotionEvent`), we have to pass a coordinate relative to the item’s on-screen location. Fortunately, Android provides some utility methods to assist with this as well.

So, let’s take a closer look at our `ACTION_DOWN` handling in `onTouchEvent()`:

```
if (action==MotionEvent.ACTION_DOWN) {
    for (OverlayItem item : items) {
        Point p=new Point(0,0);

        map.getProjection().toPixels(item.getPoint(), p);

        if (hitTest(item, marker, x-p.x, y-p.y)) {
            result=true;
            inDrag=item;
            items.remove(inDrag);
            populate();

            xDragTouchOffset=0;
            yDragTouchOffset=0;

            setDragImagePosition(p.x, p.y);
            dragImage.setVisibility(View.VISIBLE);

            xDragTouchOffset=x-p.x;
            yDragTouchOffset=y-p.y;

            break;
        }
    }
}
```

```
}  
}
```

When we get an `ACTION_DOWN` event, we iterate over the items in our `ItemizedOverlay`. For each, we determine the item's screen coordinates using the `toPixels()` method on a `Projection`, converting the latitude and longitude of the item.

To convert our touch event ( $x, y$ ) coordinates to be relative to the item, we simply have to subtract the coordinates of the item from our event's coordinates. That can then be fed into the `hitTest()` method, which will return `true` or `false` depending on whether this item is near the touch location.

Of course, identifying the item the user chose to drag is only the first step.

### Dragging the Item

A drag-and-drop operation usually involves whatever the user is dragging to appear to move across the screen in concert with the user's finger, mouse, or other pointing device. In the case of our `ItemizedOverlay`, this means we want to show the steady progression of the item across the screen, so long as the user has their finger continuously sliding on the screen.

To do that, we will:

1. Hide the item in the overlay when the user touches it (`ACTION_DOWN`)
2. Draw the icon for the item above the map while the user is dragging it (`ACTION_MOVE`)
3. Put the item back in the overlay — at the right geographic coordinates — when the user lifts their finger (`ACTION_UP`)

Hiding an overlay item is simply a matter of removing it from the `ItemizedOverlay` and calling `populate()` again.

To render our icon during the drag operation, we can add an `ImageView` to our layout, as a later child of the `RelativeLayout` holding the `MapView`, so the image appears to float over the map:

```
<?xml version="1.0" encoding="utf-8"?>  
<RelativeLayout xmlns:android="http://schemas.android.com/apk/res/android"  
    android:layout_width="match_parent"  
    android:layout_height="match_parent">  
    <com.google.android.maps.MapView android:id="@+id/map"
```

## MAPPING WITH THE LEGACY MAPVIEW

---

```
    android:layout_width="match_parent"
    android:layout_height="match_parent"
    android:apiKey="0mj160ufrY-tHs6WFurtL7rsYyEMpdEqBCbyjXg"
    android:clickable="true"
  />
  <ImageView android:id="@+id/drag"
    android:layout_width="wrap_content"
    android:layout_height="wrap_content"
    android:src="@drawable/marker"
    android:visibility="gone"
  />
</RelativeLayout>
```

Then, after we remove the item from the overlay, we take the formerly-hidden `ImageView`, make it visible, and position it based on where the item had been a moment ago on the screen. This requires a pair of offset values:

1. We need to know where in the image the point of our push-pin is (`xDragImageOffset`, `yDragImageOffset`)
2. We need to know where, relative to the image, the user put their finger (`xDragTouchOffset`, `yDragTouchOffset`)

The values for `xDragImageOffset` and `yDragImageOffset` do not change, so long as we are using the same icon. Hence, we can calculate these once, up in our `SitesOverlay` constructor:

```
dragImage=(ImageView)findViewById(R.id.drag);
xDragImageOffset=dragImage.getDrawable().getIntrinsicWidth()/2;
yDragImageOffset=dragImage.getDrawable().getIntrinsicHeight();
```

The values for `xDragTouchOffset` and `yDragTouchOffset` are based on where the item is and where the finger touched the screen.

This relies on some calculations in a `setDragImagePosition()` method on `SitesOverlay`:

```
private void setDragImagePosition(int x, int y) {
    RelativeLayout.LayoutParams lp=
        (RelativeLayout.LayoutParams)dragImage.getLayoutParams();

    lp.setMargins(x-xDragImageOffset-xDragTouchOffset,
        y-yDragImageOffset-yDragTouchOffset, 0, 0);
    dragImage.setLayoutParams(lp);
}
```

Whenever we receive an `ACTION_MOVE` while we are dragging an item, we simply reposition our `ImageView` to the new location, using the pre-computed offsets:



## MAPPING WITH THE LEGACY MAPVIEW

---

```
else if (action==MotionEvent.ACTION_MOVE && inDrag!=null) {
    setDragImagePosition(x, y);
    result=true;
}
```

Finally, when the user lifts their finger and we get an ACTION\_UP (while we are dragging an item), we can hide the ImageView, convert the final screen coordinate back into latitude and longitude, and put our item back in the ItemizedOverlay at that position:

```
else if (action==MotionEvent.ACTION_UP && inDrag!=null) {
    dragImage.setVisibility(View.GONE);

    GeoPoint pt=map.getProjection().fromPixels(x-xDragTouchOffset,
                                                y-yDragTouchOffset);
    OverlayItem toDrop=new OverlayItem(pt, inDrag.getTitle(),
                                        inDrag.getSnippet());

    items.add(toDrop);
    populate();

    inDrag=null;
    result=true;
}
```

Note that this sample only supports dragging via a single finger – in other words, it does not support multi-touch operations.

### Libraries

You can make a library, declared via `<uses-library>`, not required, via `android:required="false"`. However, then you will need to take steps on your own to determine if you do indeed have access to the library. A common pattern for this is to use `Class.forName()` to go look for some class from that library that you need — if the lookup fails with a `ClassNotFoundException`, then you do not have the library.

For an example of this, take a look at the [Maps/NooYawkMapLess](#). sample project.

The rest of the NooYawk sample app series have the LAUNCHER activity be the `MapActivity`. That, though, means that we absolutely need to have the Google Maps SDK add-on, since if `MapActivity` does not exist, our app will crash when launched. The `NooYawkMapLess` sample app, instead, has two activities, with the LAUNCHER activity *not* being the `MapActivity`:

## MAPPING WITH THE LEGACY MAPVIEW

---

```
<activity android:label="@string/app_name"
          android:name=".MapDetector"
          android:theme="@android:style/Theme.NoDisplay">
  <intent-filter>
    <action android:name="android.intent.action.MAIN" />
    <category android:name="android.intent.category.LAUNCHER" />
  </intent-filter>
</activity>
<activity android:label="@string/app_name"
          android:name=".NooYawk" />
```

Note that our MapDetector activity has `android:theme="@android:style/Theme.NoDisplay"`, so it will have no user interface of its own. Rather, it is there to detect whether MapActivity is available or not, then route control as needed based upon that determination:

```
package com.commonware.android.maps;

import android.app.Activity;
import android.content.Intent;
import android.os.Bundle;
import android.widget.Toast;

public class MapDetector extends Activity {
  @Override
  public void onCreate(Bundle instanceState) {
    super.onCreate(instanceState);

    try {
      Class.forName("com.google.android.maps.MapActivity");
      startActivity(new Intent(this, NooYawk.class));
    }
    catch (Exception e) {
      Toast
        .makeText(this,
                  "Google Maps are not available -- sorry!",
                  Toast.LENGTH_LONG)
        .show();
    }

    finish();
  }
}
```

All we do is use `Class.forName()` to try to see if `com.google.android.maps.MapActivity` exists or not. If it does, we launch the NooYawk activity. If not, we raise a Toast to let the user know about the issue. In a production app, instead of the Toast, we might route to some alternative means of displaying a map, such as using a `WebViewFragment` to display a JavaScript-based

## MAPPING WITH THE LEGACY MAPVIEW

---

Google Maps page. In either case, we finish() the MapDetector, so it is not in the back stack.

# Custom Drawables

---

Many times, our artwork can simply be some PNG or JPEG files, perhaps with different variations in different resource directories by density.

Sometimes, though, we need something more.

In addition to supporting standard PNG and JPEG files, Android has a number of custom drawable resource formats — mostly written in XML — that handle specific scenarios.

For example, you may wish to customize “the background” of a `Button`, but a `Button` really has several different background images for different circumstances (normal, pressed, focused, disabled, etc.). Android has a certain type of drawable resource that aggregates other drawable resources, indicating which of those other resources should be used in different circumstances (e.g., for a normal button use X, for a disabled button use Y).

In this chapter, we will explore these non-traditional types of “drawables” and how you can use them within your apps.

## Prerequisites

Understanding this chapter requires that you have read the core chapters, particularly the ones on [basic resources](#) and [basic widgets](#).

Having read the chapters on [animators](#) and [legacy animations](#) would be useful. |

## AnimationDrawable

The original way of doing animation on the Web was via the animated GIF. An individual GIF file could contain many frames, and the browser would switch between those frames to display a basic animated effect. This was used by Web designers for things both good (animated progress “spinners”) and bad (“hit the monkey” ad banners).

Android, on the whole, does not support animated GIF files, certainly not as regular images for use with widgets like `ImageView`.

However, there are times where having this sort of frame-by-frame animation would be useful. For example, in [an upcoming chapter](#), we will look at `ProgressBar`, which is Android’s primary way of demonstrating progress of background work. You may wish to customize the “spinning wheel” image that Android uses by default, to match your app’s color scheme, or to spin your company logo, or whatever. On the Web, particularly on older browsers, you might use an animated GIF for that — on Android, that is not an option.

An `AnimationDrawable`, though, is an option.

`AnimationDrawable` has the net effect of an animated GIF:

- You define a series of images that serve as the frames of the animation
- You define how long each of those images should be on the screen
- You define whether the animation should loop back to the beginning after it reaches the end or not

However, rather than encoding all of this in an animated GIF, you instead encode this information in an XML file, stored as a drawable resource.

XML-encoded drawable resources are typically stored in a drawable directory that does *not* contain density information, such as `res/drawable/`. That is because the XML-encoded drawable resources are density-invariant: they behave the same regardless of density. Those, like the `AnimationDrawable`, that refer to other images might well refer to other images that are stored in density-dependent resource directories, but the XML-encoded drawable itself is independent of density.

An `AnimationDrawable` is defined as in XML with a root `<animation-list>` element, containing a series of `<item>` elements for each frame:

## CUSTOM DRAWABLES

---

```
<animation-list xmlns:android="http://schemas.android.com/apk/res/android"
    android:oneshot="true">
    <item android:drawable="@drawable/frame1" android:duration="250" />
    <item android:drawable="@drawable/frame2" android:duration="250" />
    <item android:drawable="@drawable/frame3" android:duration="250" />
    <item android:drawable="@drawable/frame4" android:duration="250" />
</animation-list>
```

The root `<animation-list>` element can have an `android:oneshot` attribute, indicating whether the animation should repeat after displaying the last frame (false) or stop (true).

The `<item>` elements have `android:drawable` attributes pointing to the individual images for the individual frames. Usually these frames are PNG or JPEG files, but you refer to them as drawable resources, using `@drawable` syntax, so Android can find the right image based upon the density (or other characteristics) of the current device. The `<item>` elements also need an `android:duration` attribute, specifying the time in milliseconds that this frame should be on the screen. While the above example has all durations the same, that is not required.

For example, the Android OS uses `AnimationDrawable` resources in a few places. One is for the download icon used in a Notification for use with `DownloadManager` and similar situations. That drawable resource – `stat_sys_download.xml` — looks like this:

```
<?xml version="1.0" encoding="utf-8"?>
<!--
/* //device/apps/common/res/drawable/status_icon_background.xml
**
** Copyright 2008, The Android Open Source Project
**
** Licensed under the Apache License, Version 2.0 (the "License");
** you may not use this file except in compliance with the License.
** You may obtain a copy of the License at
**
**     http://www.apache.org/licenses/LICENSE-2.0
**
** Unless required by applicable law or agreed to in writing, software
** distributed under the License is distributed on an "AS IS" BASIS,
** WITHOUT WARRANTIES OR CONDITIONS OF ANY KIND, either express or implied.
** See the License for the specific language governing permissions and
** limitations under the License.
*/
-->
<animation-list
    xmlns:android="http://schemas.android.com/apk/res/android"
    android:oneshot="false">
    <item android:drawable="@drawable/stat_sys_download_anim0"
android:duration="200" />
```

---

## CUSTOM DRAWABLES

---

```
<item android:drawable="@drawable/stat_sys_download_anim1"
android:duration="200" />
<item android:drawable="@drawable/stat_sys_download_anim2"
android:duration="200" />
<item android:drawable="@drawable/stat_sys_download_anim3"
android:duration="200" />
<item android:drawable="@drawable/stat_sys_download_anim4"
android:duration="200" />
<item android:drawable="@drawable/stat_sys_download_anim5"
android:duration="200" />
</animation-list>
```

Here, we have a repeating animation (`android:oneshot="false"`), consisting of six frames, each on the screen for 200 milliseconds.

By specifying an `AnimationDrawable` in your `Notification` for its icon, you too can have this sort of animated effect. Of course, the animation is “fire and forget”: other than by removing or replacing the `Notification`, you cannot affect the animation in any other way.

## StateListDrawable

Another XML-defined drawable resource, the `StateListDrawable`, is key if you want to have different images when widgets are in different states.

As outlined in the introduction to this chapter, what makes a `Button` visually be a `Button` is its background. To handle different looks for the `Button` background for different states (normal, pressed, disabled, etc.), the standard `Button` background is a `StateListDrawable`, one that looks something like this:

```
<?xml version="1.0" encoding="utf-8"?>
<!-- Copyright (C) 2008 The Android Open Source Project

Licensed under the Apache License, Version 2.0 (the "License");
you may not use this file except in compliance with the License.
You may obtain a copy of the License at

    http://www.apache.org/licenses/LICENSE-2.0

Unless required by applicable law or agreed to in writing, software
distributed under the License is distributed on an "AS IS" BASIS,
WITHOUT WARRANTIES OR CONDITIONS OF ANY KIND, either express or implied.
See the License for the specific language governing permissions and
limitations under the License.
-->
<selector xmlns:android="http://schemas.android.com/apk/res/android">
```

## CUSTOM DRAWABLES

---

```
<item android:state_window_focused="false" android:state_enabled="true"
    android:drawable="@drawable/btn_default_normal" />
<item android:state_window_focused="false" android:state_enabled="false"
    android:drawable="@drawable/btn_default_normal_disable" />
<item android:state_pressed="true"
    android:drawable="@drawable/btn_default_pressed" />
<item android:state_focused="true" android:state_enabled="true"
    android:drawable="@drawable/btn_default_selected" />
<item android:state_enabled="true"
    android:drawable="@drawable/btn_default_normal" />
<item android:state_focused="true"
    android:drawable="@drawable/btn_default_normal_disable_focused" />
<item
    android:drawable="@drawable/btn_default_normal_disable" />
</selector>
```

The XML has a `<selector>` root element, indicating this is a `StateListDrawable`. The `<item>` elements inside the root describe what Drawable resource should be used if the `StateListDrawable` is being used in some state. For example, if the “window” (think activity or dialog) does not have the focus (`android:state_window_focused="false"`) and the Button is enabled (`android:state_enabled="true"`), then we use the `@drawable/btn_default_normal` Drawable resource. That resource, as it turns out, is a nine-patch PNG file, described [later in this chapter](#).

Android applies each rule in turn, top-down, to find the Drawable to use for a given state of the `StateListDrawable`. The last rule has no `android:state_*` attributes, meaning it is the overall default image to use if none of the other rules match.

So, if you want to change the background of a Button, you need to:

- Copy the above resource, found in your Android SDK as `res/drawable/btn_default.xml` inside any of the `platforms/` directories, into your project
- Copy each of the Button state nine-patch images into your project
- Modify whichever of those nine-patch images you want, to affect the visual change you seek
- If need be, tweak the states and images defined in the `StateListDrawable` XML you copied
- Reference the local `StateListDrawable` as the background for your Button

The backgrounds of most widgets that have backgrounds by default will use a `StateListDrawable`. Searching a platform version’s `res/drawable/` directory for XML files containing `<selector>` elements comes up with a rather long list.



## LayerDrawable

A LayerDrawable basically stacks a bunch of other drawables on top of each other. Later drawables are drawn on top of earlier drawables, much as later children of a RelativeLayout are drawn on top of earlier children.

Typically, you will create a LayerDrawable via a <layer-list> XML drawable resource.

For example, a ToggleButton widget has a LayerDrawable as its background:

```
?xml version="1.0" encoding="utf-8"?>
<!-- Copyright (C) 2008 The Android Open Source Project

Licensed under the Apache License, Version 2.0 (the "License");
you may not use this file except in compliance with the License.
You may obtain a copy of the License at

    http://www.apache.org/licenses/LICENSE-2.0

Unless required by applicable law or agreed to in writing, software
distributed under the License is distributed on an "AS IS" BASIS,
WITHOUT WARRANTIES OR CONDITIONS OF ANY KIND, either express or implied.
See the License for the specific language governing permissions and
limitations under the License.
-->
<layer-list xmlns:android="http://schemas.android.com/apk/res/android">
    <item android:id="@+android:id/background"
android:drawable="@android:drawable/btn_default_small" />
    <item android:id="@+android:id/toggle" android:drawable="@android:drawable/
btn_toggle" />
</layer-list>
```

This LayerDrawable draws two images on top of each other. One is a standard small button background (@android:drawable/btn\_default\_small). The other is the actual face of the toggle itself — a StateListDrawable that uses different images for checked and unchecked states.

In the <layer-list>, you can have several <item> elements. Each <item> element usually will need an android:drawable attribute, pointing to the drawable that should be drawn. Optionally, you can assign ID values to the items via android:id attributes, much like you would do for widgets in a layout XML resource. Later on, you can call findDrawableByLayerId() on the LayerDrawable to retrieve an individual Drawable representing the layer, given its android:id value.

There are also `android:left`, `android:right`, `android:top`, and `android:bottom` attributes, which you can use to provide dimension values to offset an image within the layered set. For example, you could use `android:left` to inset one of the layers by a certain number of pixels (or dp or whatever).

By default, the layers in the `LayerDrawable` are scaled to fit the size of whatever `View` is holding them (e.g., the size of the `ToggleButton` using the `LayerDrawable` as a background). To prevent this, you can skip the `android:drawable` attribute, and instead nest a `<bitmap>` element inside the `<item>`, where you can provide an `android:gravity` attribute to control how the image should be handled relative to its containing `View`. We will get more into nested `<bitmap>` elements [later in this chapter](#).

## TransitionDrawable

A `TransitionDrawable` is a `LayerDrawable` with one added feature: for a two-layer drawable, it can smoothly transition from showing one layer to another on top.

For example, you may have noticed that when you tap-and-hold on a row in a `ListView` that the selector highlight has an animated effect, slowly shifting colors from the color used for a simple click to one signifying that you have long-clicked the row. Android accomplishes this via a `TransitionDrawable`, set up as a `<transition>` XML drawable resource:

```
<?xml version="1.0" encoding="utf-8"?>
<!-- Copyright (C) 2008 The Android Open Source Project

Licensed under the Apache License, Version 2.0 (the "License");
you may not use this file except in compliance with the License.
You may obtain a copy of the License at

    http://www.apache.org/licenses/LICENSE-2.0

Unless required by applicable law or agreed to in writing, software
distributed under the License is distributed on an "AS IS" BASIS,
WITHOUT WARRANTIES OR CONDITIONS OF ANY KIND, either express or implied.
See the License for the specific language governing permissions and
limitations under the License.
-->
<transition xmlns:android="http://schemas.android.com/apk/res/android">
    <item android:drawable="@android:drawable/list_selector_background_pressed"
    />
    <item android:drawable="@android:drawable/
list_selector_background_longpress" />
</transition>
```

The `TransitionDrawable` object has a `startTransition()` method that you can use, that will have Android smoothly switch from the first drawable to the second. You specify the duration of the transition as a number of milliseconds passed to `startTransition()`. There are also options to reverse the transition, set up more of a cross-fade effect, and the like.

## LevelListDrawable

A `LevelListDrawable` is similar in some respects to a `StateListDrawable`, insofar as one specific item from the “list drawable” will be displayed based upon certain conditions. In the case of `StateListDrawable`, the conditions are based upon the state of the widget using the drawable (e.g., checked, pressed, disabled). In the case of `LevelListDrawable`, it is merely an integer level.

For example, the status or system bar of your average Android device has an icon indicating the battery charge level. That is actually implemented as a `LevelListDrawable`, via an XML resource containing a root `<level-list>` element:

```
<?xml version="1.0" encoding="utf-8"?>
<!--
/* //device/apps/common/res/drawable/stat_sys_battery.xml
**
** Copyright 2007, The Android Open Source Project
**
** Licensed under the Apache License, Version 2.0 (the "License");
** you may not use this file except in compliance with the License.
** You may obtain a copy of the License at
**
**     http://www.apache.org/licenses/LICENSE-2.0
**
** Unless required by applicable law or agreed to in writing, software
** distributed under the License is distributed on an "AS IS" BASIS,
** WITHOUT WARRANTIES OR CONDITIONS OF ANY KIND, either express or implied.
** See the License for the specific language governing permissions and
** limitations under the License.
*/
-->

<level-list xmlns:android="http://schemas.android.com/apk/res/android">
    <item android:maxLevel="4" android:drawable="@android:drawable/
stat_sys_battery_0" />
    <item android:maxLevel="15" android:drawable="@android:drawable/
stat_sys_battery_15" />
    <item android:maxLevel="35" android:drawable="@android:drawable/
stat_sys_battery_28" />
    <item android:maxLevel="49" android:drawable="@android:drawable/
stat_sys_battery_43" />
    <item android:maxLevel="60" android:drawable="@android:drawable/
```

```
stat_sys_battery_57" />
    <item android:maxLevel="75" android:drawable="@android:drawable/
stat_sys_battery_71" />
    <item android:maxLevel="90" android:drawable="@android:drawable/
stat_sys_battery_85" />
    <item android:maxLevel="100" android:drawable="@android:drawable/
stat_sys_battery_100" />
</level-list>
```

This `LevelListDrawable` has eight items, whose `android:drawable` attributes point to specific other drawable resources (in this case, standard PNG files with different implementations for different densities). Each `<item>` has an `android:maxLevel` value. When someone calls `setLevel()` on the `Drawable` or `setImageLevel()` on the `ImageView`, Android will choose the item with the lowest `maxLevel` that meets or exceeds the requested level, and show that. In the case of the battery icon, when the battery level changes, the status bar picks up that change and calls `setImageLevel()` with the battery charge percentage (expressed as an integer from 0–100) — that, in turn, triggers the right PNG file to be displayed.

Another use of `LevelListDrawable` is with a `RemoteViews`, such as for an app widget. The `setImageLevel()` method is “remotable”, despite not being directly part of the `RemoteViews` API. Hence, given that you use a `LevelListDrawable` in your app widget’s layout, you should be able to use `setInt()` with a method name of “setImageLevel” to have the app widget update to display the proper image.

## ScaleDrawable and ClipDrawable

A `ScaleDrawable` does pretty much what its name suggests: it scales another drawable. A `ClipDrawable` does pretty much what *its* name suggests: it clips another drawable.

How they do this, and how you control it, requires a bit more explanation.

Like `LevelListDrawable`, `ScaleDrawable` and `ClipDrawable` leverage the `setLevel()` method on `Drawable` (or the `setImageLevel()` method on `ImageView`). Whereas `LevelListDrawable` uses this to choose an individual image out of a set of possible images, `ScaleDrawable` and `ClipDrawable` use the level to control how much an image should be scaled or clipped. For this, they support a range of levels from 0 to 10000.

### Scaling

For a level of 0, `ScaleDrawable` will not draw anything. For a level from 1 to 10000, `ScaleDrawable` will scale an image from a configurable minimum size to the bounds of the `View` to which the drawable is applied.

The amount of scaling is determined by `android:scaleHeight` and `android:scaleWidth` attributes:

```
<?xml version="1.0" encoding="utf-8"?>
<scale xmlns:android="http://schemas.android.com/apk/res/android"
  android:drawable="@android:drawable/btn_default"
  android:scaleGravity="left|top"
  android:scaleHeight="50%"
  android:scaleWidth="50%"/>
```

The above `ScaleDrawable` (denoted by the `<scale>` root element) says that we should scale both height and width of the underlying drawable to 50% of the available space for the drawable, when the level is at its maximum (10000).

Note that you do not have to scale along both dimensions. If, for example, you kept `android:scaleWidth` but deleted `android:scaleHeight`, `setImageLevel()` would control the scaled width of the underlying image (provided via `android:drawable`) but not the height.

The `android:scaleGravity` attribute indicates where the scaled image should reside within the available space (the 10000 level, determined by the bounds of the `View` to which the drawable is applied). The value shown above, `center`, keeps the image centered within the available space, and shrinks or expands it around the center. A value of `left|top` would keep the image in the upper-left corner of the space, having the visual effect of moving the lower-right corner based upon the supplied level.

### Clipping

Scaling proportionally reduces the height and/or width of an image. Clipping, on the other hand, chops off part of the height or width of the image.

```
<clip xmlns:android="http://schemas.android.com/apk/res/android"
  android:clipOrientation="horizontal"
  android:drawable="@drawable/btn_default_normal"
  android:gravity="left"/>
```

In this sample `ClipDrawable` (indicated by the `<clip>` root element), we are going to allow the level to chop off part of the image indicated by the `android:drawable` attribute. Our `android:clipOrientation`, set to `horizontal`, means we are going to chop off part of the width (`vertical` would have us chop off part of the height). The amount that is going to be chopped off is the level you supply (e.g., `setImageLevel()` divided by `10000`). Hence, a level of `5000` will chop off `0.5` (a.k.a., `50%`) of the image.

Where in the image the clipping occurs is determined by the `android:gravity` attribute. An `android:clipOrientation` of `horizontal` and an `android:gravity` of `left`, as in the sample drawable above, means that the left side of the image is retained, and the image will be clipped on the right. Specifying `right` instead of `left` would reverse that, clipping the image from the right, while `center` would clip equally from both sides. There are other gravity values as well, such as `top` and `bottom` values to be used with a vertical orientation.

### Seeing It In Action

To see these effects, take a look at the [Drawable/ScaleClip](#) sample project. This is derived from [an earlier example](#) showing how to use `ViewPager` with `PagerTabStrip`. In that example, we had 10 tabs, each being a large `EditText` widget. In this example, we have 2 tabs, “Scale” and “Clip”, both using the same layout:

```
<RelativeLayout xmlns:android="http://schemas.android.com/apk/res/android"
    android:layout_width="match_parent"
    android:layout_height="match_parent">

    <ImageView
        android:id="@+id/image"
        android:layout_width="150dp"
        android:layout_height="150dp"
        android:layout_centerHorizontal="true"
        android:layout_marginTop="20dp"
        android:scaleType="fitXY"/>

    <SeekBar
        android:id="@+id/level"
        android:layout_width="match_parent"
        android:layout_height="wrap_content"
        android:layout_alignParentBottom="true"
        android:layout_marginBottom="20dp"
        android:layout_marginLeft="20dp"
        android:layout_marginRight="20dp"
        android:max="10000"
        android:progress="10000"/>

</RelativeLayout>
```

## CUSTOM DRAWABLES

---

This is simply a 150dp square ImageView towards the top of the screen and a SeekBar towards the bottom of the screen. The SeekBar will be used to control the level applied to a ScaleDrawable and ClipDrawable, which is why we have android:max set to 10000. We also have our “progress” (original SeekBar value) set to 10000, so the bar’s thumb will be fully slid over to the right at the outset.

The fragments that we will use for the tabs both inherit from a common abstract FragmentBase class:

```
package com.commonware.android.scaleclip;

import android.os.Bundle;
import android.view.LayoutInflater;
import android.view.View;
import android.view.ViewGroup;
import android.widget.ImageView;
import android.widget.SeekBar;
import com.actionbarsherlock.app.SherlockFragment;

abstract public class FragmentBase extends SherlockFragment implements
    SeekBar.OnSeekBarChangeListener {
    abstract void setBackgroundImage(ImageView image);

    private ImageView image=null;

    @Override
    public View onCreateView(LayoutInflater inflater,
                            ViewGroup container,
                            Bundle savedInstanceState) {
        setRetainInstance(true);

        View result=inflater.inflate(R.layout.scaleclip, container, false);
        SeekBar bar=((SeekBar)result.findViewById(R.id.level));

        bar.setOnSeekBarChangeListener(this);
        image=(ImageView)result.findViewById(R.id.image);
        setBackgroundImage(image);
        image.setImageLevel(bar.getProgress());

        return(result);
    }

    @Override
    public void onProgressChanged(SeekBar seekBar, int progress,
                                  boolean fromUser) {
        image.setImageLevel(progress);
    }

    @Override
    public void onStartTrackingTouch(SeekBar seekBar) {
        // no-op
    }
}
```

## CUSTOM DRAWABLES

---

```
}  
  
@Override  
public void onStopTrackingTouch(SeekBar seekBar) {  
    // no-op  
}  
}
```

In `onCreateView()`, we inflate the above layout file, hook up the fragment itself to be the listener for `SeekBar` change events, call the subclass' `setImageBackground()` method to populate the `ImageView` with an image, and set the `ImageView`'s level to be the initial value of the `SeekBar`. When the `SeekBar` value changes, our `onProgressChanged()` method will adjust the level.

The concrete subclasses — `ScaleFragment` and `ClipFragment` — simply populate the `ImageView` with the `ScaleDrawable` and `ClipDrawable` resources shown earlier in this section:

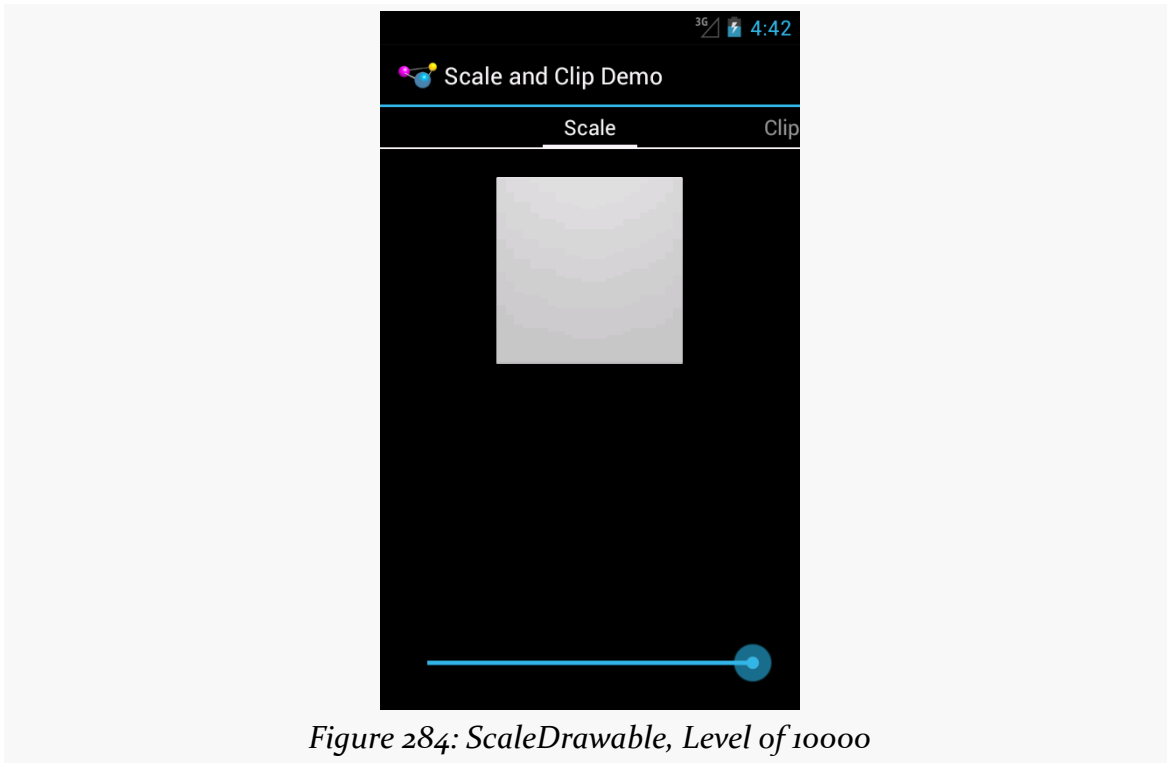
```
package com.commonware.android.scaleclip;  
  
import android.widget.ImageView;  
  
public class ScaleFragment extends FragmentBase {  
    @Override  
    void setImageBackground(ImageView image) {  
        image.setImageResource(R.drawable.scale);  
    }  
}
```

```
package com.commonware.android.scaleclip;  
  
import android.widget.ImageView;  
  
public class ClipFragment extends FragmentBase {  
    @Override  
    void setImageBackground(ImageView image) {  
        image.setImageResource(R.drawable.clip);  
    }  
}
```

Those two drawables based their scaling and clipping on `res/drawable-xdpi/btn_default_normal.9.png`. This is a slightly-modified copy of the default button background, and is a nine-patch PNG file. We will discuss nine-patch PNG files [later in this chapter](#) — suffice it to say for now that it is a PNG file with rules about how it should be stretched.

Our scale tab starts off showing the full image:



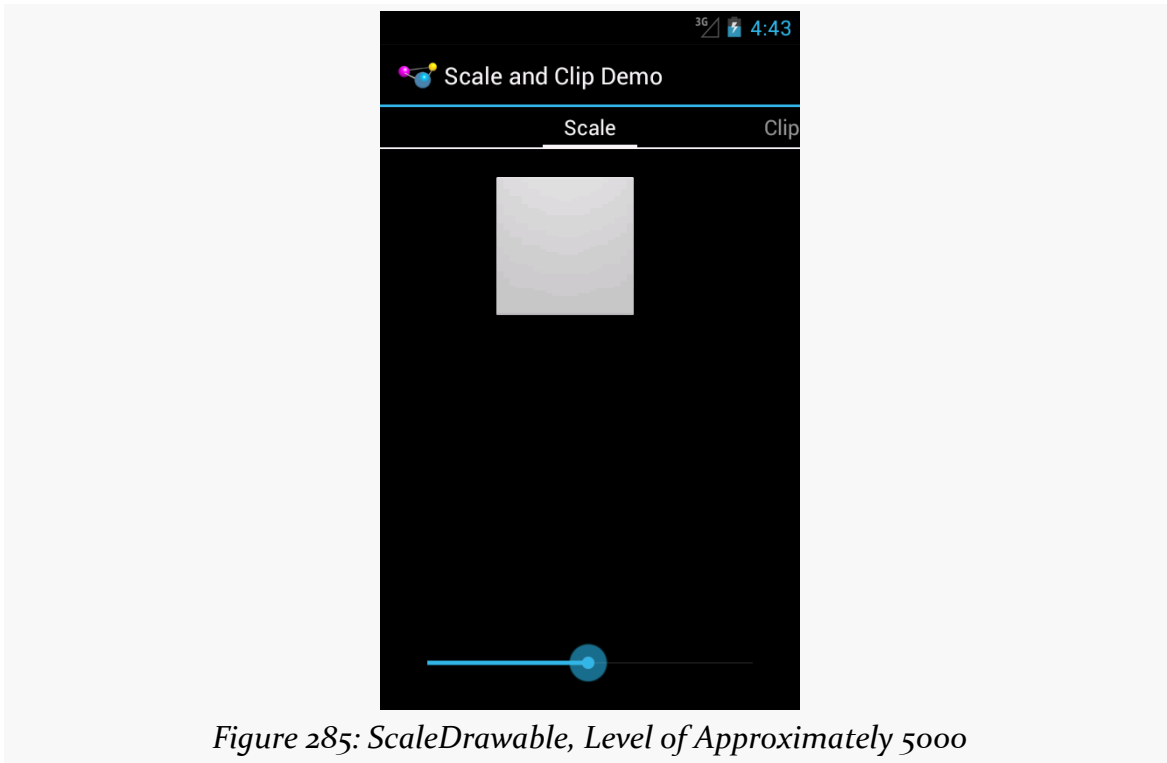


*Figure 284: ScaleDrawable, Level of 10000*

As we start sliding the SeekBar thumb to the left, the image shrinks progressively:

## CUSTOM DRAWABLES

---

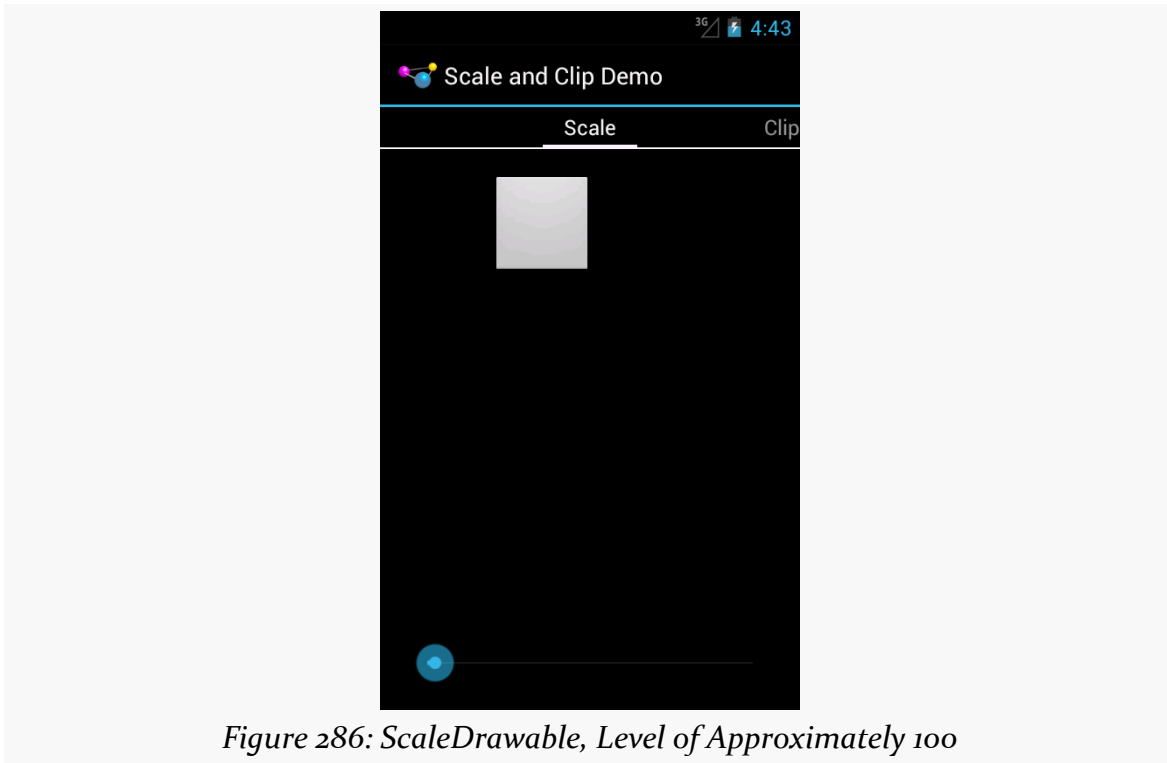


*Figure 285: ScaleDrawable, Level of Approximately 5000*

It eventually tends towards the 50% level specified in our `android:scaleHeight` and `android:scaleWidth` values:

## CUSTOM DRAWABLES

---



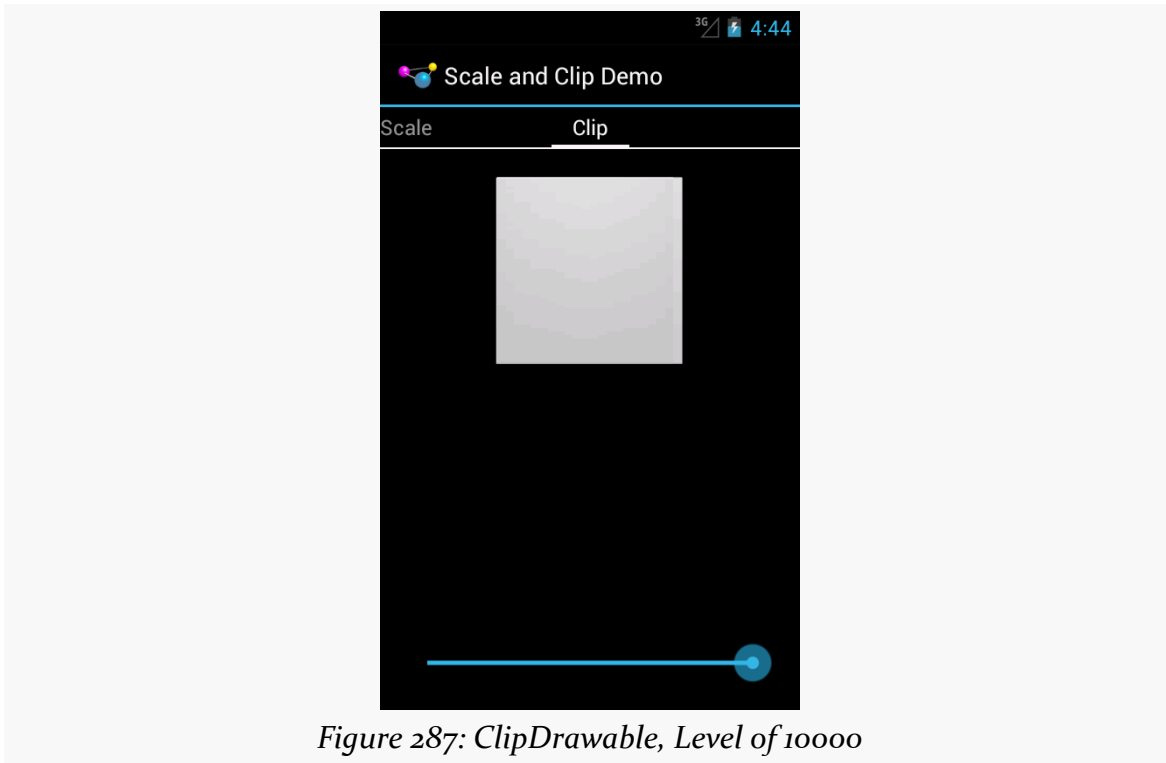
*Figure 286: ScaleDrawable, Level of Approximately 100*

Sliding it all the way to the left, though, causes the image to vanish.

The ClipDrawable starts off looking much like the ScaleDrawable:

## CUSTOM DRAWABLES

---



*Figure 287: ClipDrawable, Level of 10000*

As we slide the SeekBar to the left, the right side of the image gets clipped:



Figure 288: ClipDrawable, Level of Approximately 5000

## InsetDrawable

An InsetDrawable allows you to apply insets on any side (or all sides) of some other drawable resource. The use case cited in [the documentation](#) is “This is used when a View needs a background that is smaller than the View’s actual bounds”. However, at the present time, nothing in the Android open source code uses this particular type of resource, or even the Java class.

In principle, though, you could have an XML drawable resource that looked like this:

```
<?xml version="1.0" encoding="utf-8"?>
<inset xmlns:android="http://schemas.android.com/apk/res/android"
    android:drawable="@drawable/something_or_another"
    android:insetLeft="20dp"
    android:insetTop="10dp" />
```

When used as the background for some View, for example, Android would pull in the something\_or\_another resource and effectively add 20dp of left margin and 10dp of top margin on the background when calculating its size and drawing it on the screen.

## ShapeDrawable

Far and away the most complex of the XML drawable formats is the ShapeDrawable. It gives you what amounts to a very tiny subset of SVG, for creating simple vector art shapes.

The root element of a ShapeDrawable resource is <shape>, which may have child elements, along with attributes, to configure what gets rendered on the screen when the drawable is applied.

This section will review the elements and attributes available to you, with sample drawables (and screenshots) culled from the the [Drawable/Shape](#) sample project.

This is a “sampler” project, designed to depict a number of ShapeDrawables. To accomplish this, we will use action bar tabs, in an ActionBarSherlock-equipped project. Our activity (MainActivity) has a pair of static int arrays, one pointing at string resources to use for tab captions, the other pointing at corresponding drawable resources:

```
package com.commonware.android.shape;

import android.os.Bundle;
import android.support.v4.app.FragmentTransaction;
import android.widget.ImageView;
import com.actionbarsherlock.app.ActionBar;
import com.actionbarsherlock.app.ActionBar.Tab;
import com.actionbarsherlock.app.ActionBar.TabListener;
import com.actionbarsherlock.app.SherlockActivity;

public class MainActivity extends SherlockActivity implements
    TabListener {
    private static final int TABS[] = { R.string.solid, R.string.gradient,
        R.string.border, R.string.rounded, R.string.ring,
        R.string.layered };
    private static final int DRAWABLES[] = { R.drawable.rectangle,
        R.drawable.gradient, R.drawable.border, R.drawable.rounded,
        R.drawable.ring, R.drawable.layered };
    private ImageView image=null;

    @Override
    public void onCreate(Bundle savedInstanceState) {
        super.onCreate(savedInstanceState);
        setContentView(R.layout.activity_main);

        image=(ImageView)findViewById(R.id.image);

        ActionBar bar=getSupportActionBar();
```

## CUSTOM DRAWABLES

---

```
bar.setNavigationMode(ActionBar.NAVIGATION_MODE_TABS);

for (int i=0; i < TABS.length; i++) {
    bar.addTab(bar.newTab().setText(getString(TABS[i]))
        .setTabListener(this));
}

@Override
public void onTabSelected(Tab tab, FragmentTransaction ft) {
    image.setImageResource(DRAWABLES[tab.getPosition()]);
}

@Override
public void onTabUnselected(Tab tab, FragmentTransaction ft) {
    // no-op
}

@Override
public void onTabReselected(Tab tab, FragmentTransaction ft) {
    // no-op
}
}
```

In `onCreate()`, we toggle the `ActionBar` into tab-navigation mode, then iterate over the arrays and add one tab per element.

Our layout is an `ImageView`, named `image`, centered on the screen, taking up 80% of the horizontal space, plus has 20dp of top and bottom margin:

```
<LinearLayout xmlns:android="http://schemas.android.com/apk/res/android"
    xmlns:tools="http://schemas.android.com/tools"
    android:id="@+id/LinearLayout1"
    android:layout_width="match_parent"
    android:layout_height="match_parent"
    android:orientation="horizontal"
    android:gravity="center"
    android:weightSum="10">

    <ImageView
        android:id="@+id/image"
        android:src="@drawable/rectangle"
        android:layout_width="0dp"
        android:layout_height="match_parent"
        android:layout_marginTop="20dp"
        android:layout_marginBottom="20dp"
        android:layout_gravity="center"
        android:layout_weight="8"/>

</LinearLayout>
```

In our activity's `onTabSelected()` — implemented because the activity is the `TabListener` for our tabs — we get the position of our tab and fill in the appropriate drawable into the `ImageView`.

Given that, let's take a look at how to construct a `ShapeDrawable`, along with some sample drawables.

### **<shape>**

Your root element, not surprisingly, is `<shape>`.

The primary thing that you will define on the `<shape>` element is the redundantly-named `android:shape` attribute, to define what sort of shape you want:

- `line` (a shape with no interior)
- `oval` (also for ellipses)
- `rectangle` (including rounded rectangles)
- `ring` (for partially-filled circles)

There are some other attributes available on `<shape>` for a ring, which we will examine [later in this chapter](#).

### **<solid>**

Your shape will usually require some sort of fill, to say what color goes in the shape. There are two types of fills: solid and gradient.

For a solid fill, add a `<solid>` child element to the `<shape>`, with an `android:color` attribute indicating what color to use. As with most places in Android, this can either be a literal color or a reference to a color resource.

So, for example, we can specify a solid red rectangle as:

```
<?xml version="1.0" encoding="utf-8"?>
<shape xmlns:android="http://schemas.android.com/apk/res/android"
  android:shape="rectangle">
  <solid android:color="#FFAA0000"/>
</shape>
```

This gives us the following visual result:



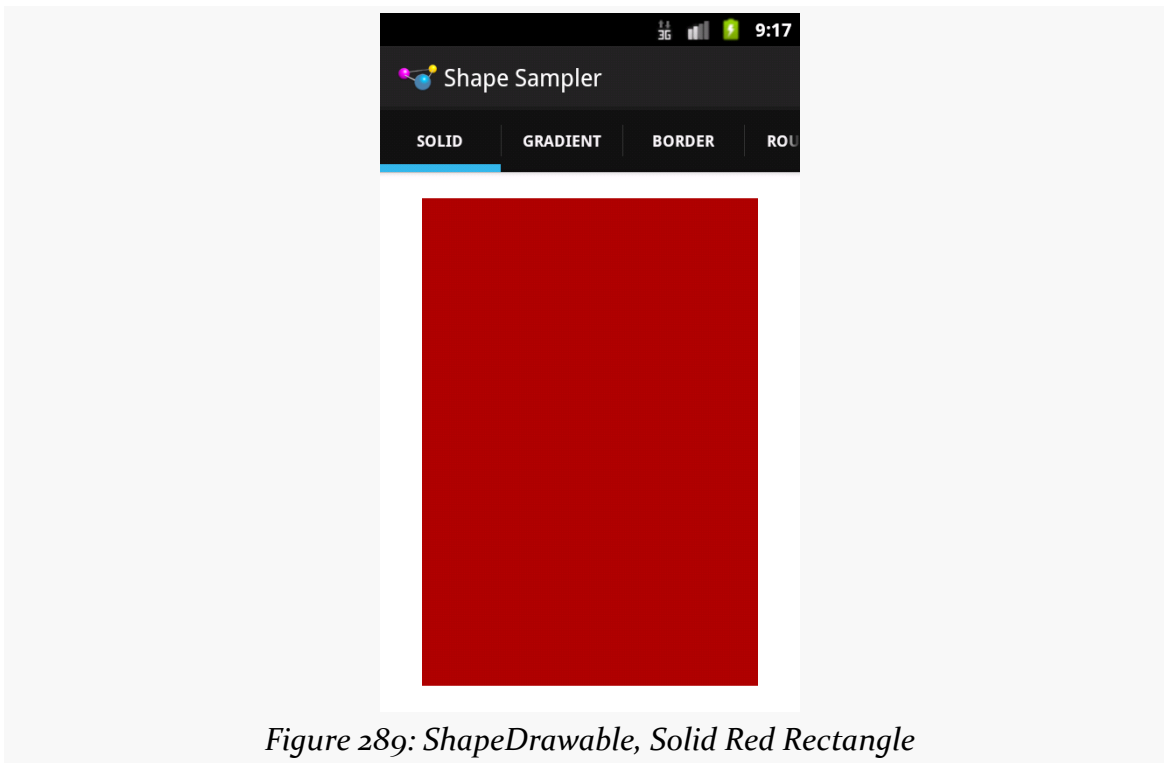


Figure 289: ShapeDrawable, Solid Red Rectangle

### <gradient>

Your alternative fill is a gradient. The nice thing about gradients with ShapeDrawable is that they are generated at runtime from the specifications in the ShapeDrawable, and therefore will be smooth. Gradients that appear in PNG files and the like, if stretched, will tend to have a banding effect.

Gradient fills are defined via a <gradient> child element of the <shape> element.

The simplest way to set up a gradient is to use three attributes:

- `android:startColor` and `android:endColor`, to specify the starting and ending colors of the gradient, respectively, and
- `android:angle`, to specify what direction the gradient “flows” in

The angle must be a multiple of 45 degrees. 0 degrees is left-to-right, 90 degrees is bottom-to-top, 180 degrees is right-to-left, and 270 degrees is top-to-bottom.

So, for example, we could change our rectangle to have a gradient fill, from red to blue, with red at the top, via:

## CUSTOM DRAWABLES

---

```
<?xml version="1.0" encoding="utf-8"?>
<shape xmlns:android="http://schemas.android.com/apk/res/android"
    android:shape="rectangle">

    <gradient
        android:angle="270"
        android:endColor="#FF0000FF"
        android:startColor="#FFFF0000"/>

</shape>
```

That gives us:

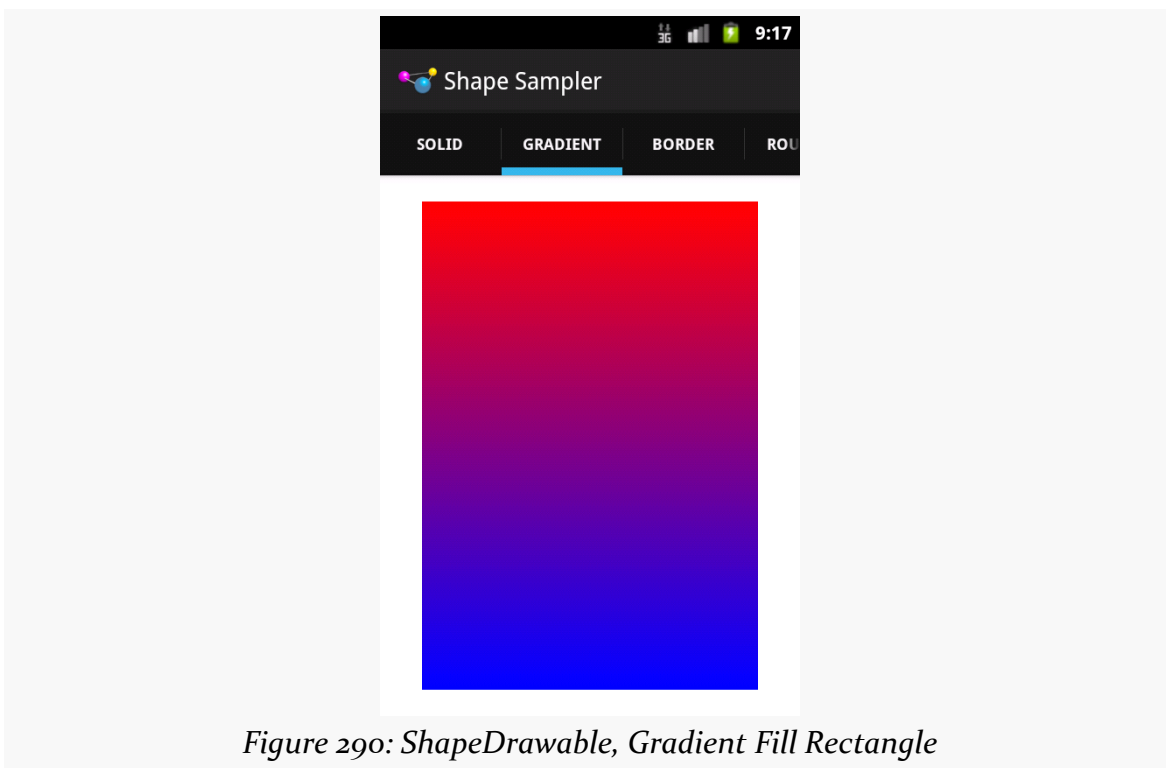


Figure 290: ShapeDrawable, Gradient Fill Rectangle

We will examine some other gradient options in the section on rings, [later in this chapter](#).

### **<stroke>**

If you want a separate color for a border around your shape, you can use the `<stroke>` element, as a child of the `<shape>` element, to configure one.

## CUSTOM DRAWABLES

---

There are four attributes that you can declare. The two that you will probably always use are `android:color` (to indicate the color of the border) and `android:width` (to indicate the thickness of the border). By default, using just those two will give you a solid line around the edge of your shape.

If you would prefer a dashed border, you can add in `android:dashWidth` (to indicate how long each dash segment should be) and `android:dashGap` (to indicate how long the gaps between dash segments should be).

So, for example, we can add a dashed border to our gradient rectangle via a suitable `<stroke>` element:

```
<?xml version="1.0" encoding="utf-8"?>
<shape xmlns:android="http://schemas.android.com/apk/res/android"
    android:shape="rectangle">

    <gradient
        android:angle="270"
        android:endColor="#FF0000FF"
        android:startColor="#FFFF0000"/>

    <stroke
        android:width="2dp"
        android:dashGap="4dp"
        android:dashWidth="20dp"
        android:color="#FF000000"/>

</shape>
```

This gives us:

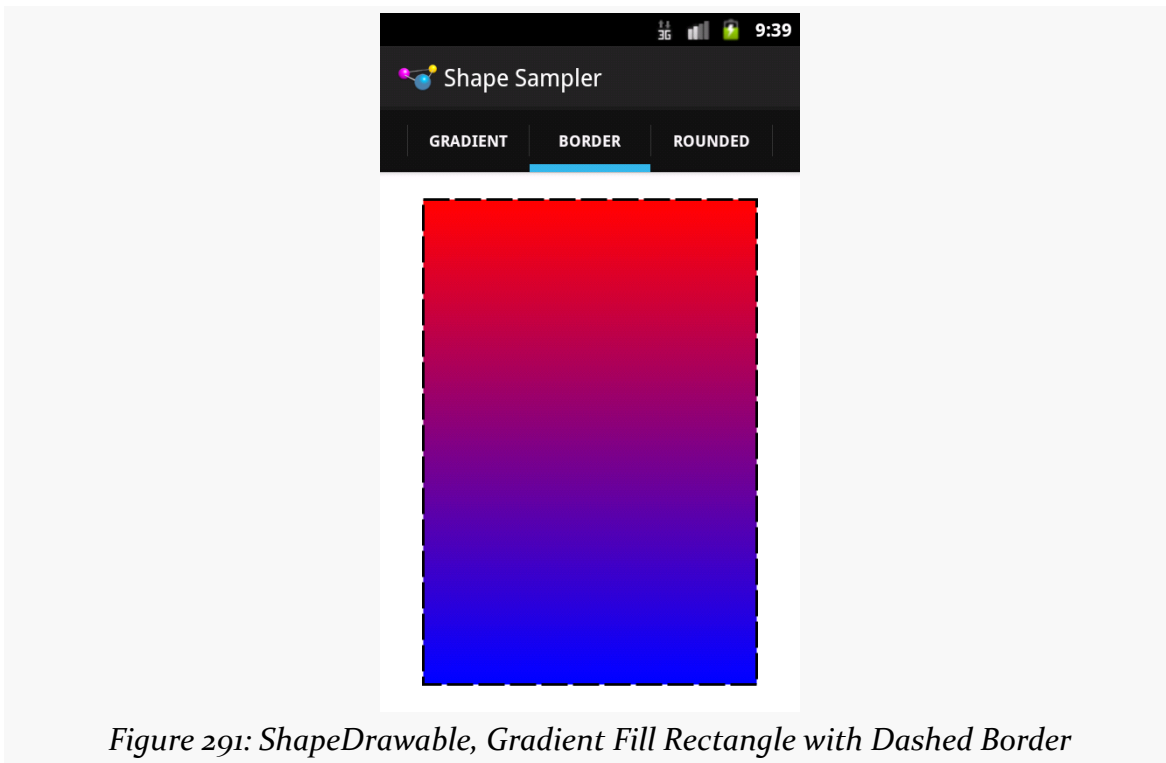


Figure 291: *ShapeDrawable, Gradient Fill Rectangle with Dashed Border*

### <corners>

If we are implementing a rectangle shape, but we really want it to be a rounded rectangle, we can add a `<corners>` element as a child of the `<shape>` element. You can specify the radius to apply to the corners, either for all corners (e.g., `android:radius`), or for individual corners (e.g., `android:topLeftRadius`). Here, “radius” basically means the size of the circle that should implement the corner, where a radius of `0dp` would indicate the default square corner.

So, if we wanted to add rounded corners to our gradient-filled, dash-outlined rectangle, we could use this:

```
<?xml version="1.0" encoding="utf-8"?>
<shape xmlns:android="http://schemas.android.com/apk/res/android"
    android:shape="rectangle">

    <gradient
        android:angle="270"
        android:endColor="#FF0000FF"
        android:startColor="#FFFF0000"/>

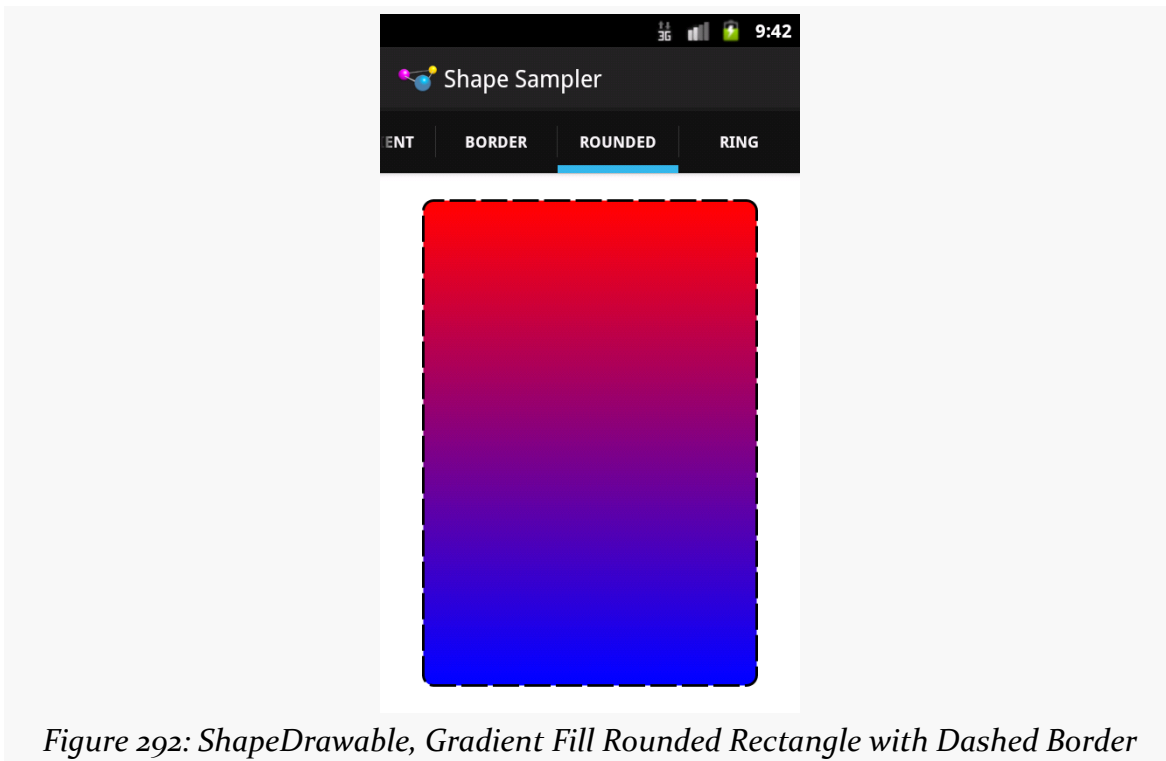
    <stroke
```

## CUSTOM DRAWABLES

---

```
    android:dashGap="4dp"  
    android:dashWidth="20dp"  
    android:width="2dp"  
    android:color="#FF000000" />  
  
    <corners android:radius="8dp" />  
  
</shape>
```

This gives us the following:



*Figure 292: ShapeDrawable, Gradient Fill Rounded Rectangle with Dashed Border*

### **<padding> and <size>**

There are also `<padding>` and `<size>` elements that you can add, that specify padding to put on the various sides and the overall size of the drawable. More often than not, you would actually handle this on the `ImageView` or other widget that is using your drawable, but if you would prefer to define those things in the drawable itself, you are welcome to do so.

## Put a Ring On It

Rings are a bit more complicated, in large part because they are not completely filled. With a ring, the “fill” is filling what goes in the ring itself, not the “hole” in the center of the ring. This means that we need to teach Android more about how that “hole” is supposed to be set up.

To do that, we need to provide two pieces of information:

1. How big the inner radius should be, where by “inner radius” Android means “the radius of the hole”
2. How thick the ring should be

The ring will then be drawn based upon that inner radius and thickness.

You might wonder, “well, where does the size of the actual drawable come into play?” After all, if we specify an inner radius of 20dp and a thickness of 10dp, that would give us an outer radius of 30dp, for a total width of 60dp... regardless of how big the actual drawable is.

And that is completely correct.

However, for both the inner radius and the thickness, you have two choices of how to specify their values:

1. As actual sizes (dimensions or references to dimension resources)
2. As ratios to the overall drawable width (defined by <size> or the widget that is using the drawable)

This gives us four total attributes to choose from, to be placed on the <shape> element for ring drawables:

1. `android:innerRadius`
2. `android:innerRadiusRatio`
3. `android:thickness`
4. `android:thicknessRatio`

Therefore, if you want the ring’s size to be based on the size of the drawable, you would use `innerRadiusRatio`, `thicknessRatio`, or both.

## CUSTOM DRAWABLES

---

The other thing about rings is that they are round. Hence, a default linear gradient fill — going from one side of the drawable to another — may not be what you really want. You can control the type of gradient fill to use via the `android:type` attribute on the `<gradient>` element. There are three possible values:

1. `linear` (the default behavior)
2. `radial`, where the gradient starts from the center (or another point that you define) and changes color from that center to the edges
3. `sweep`, where the gradient revolves clockwise in a circle, starting from whatever `android:angle` you specify (or 0, meaning “east”, as the default)

So, for example, take a look at the following `ShapeDrawable`:

```
<?xml version="1.0" encoding="utf-8"?>
<shape xmlns:android="http://schemas.android.com/apk/res/android"
    android:innerRadiusRatio="3"
    android:shape="ring"
    android:thickness="15dp"
    android:useLevel="false">

    <gradient
        android:centerColor="#4c737373"
        android:endColor="#ff9933CC"
        android:startColor="#4c737373"
        android:type="sweep" />

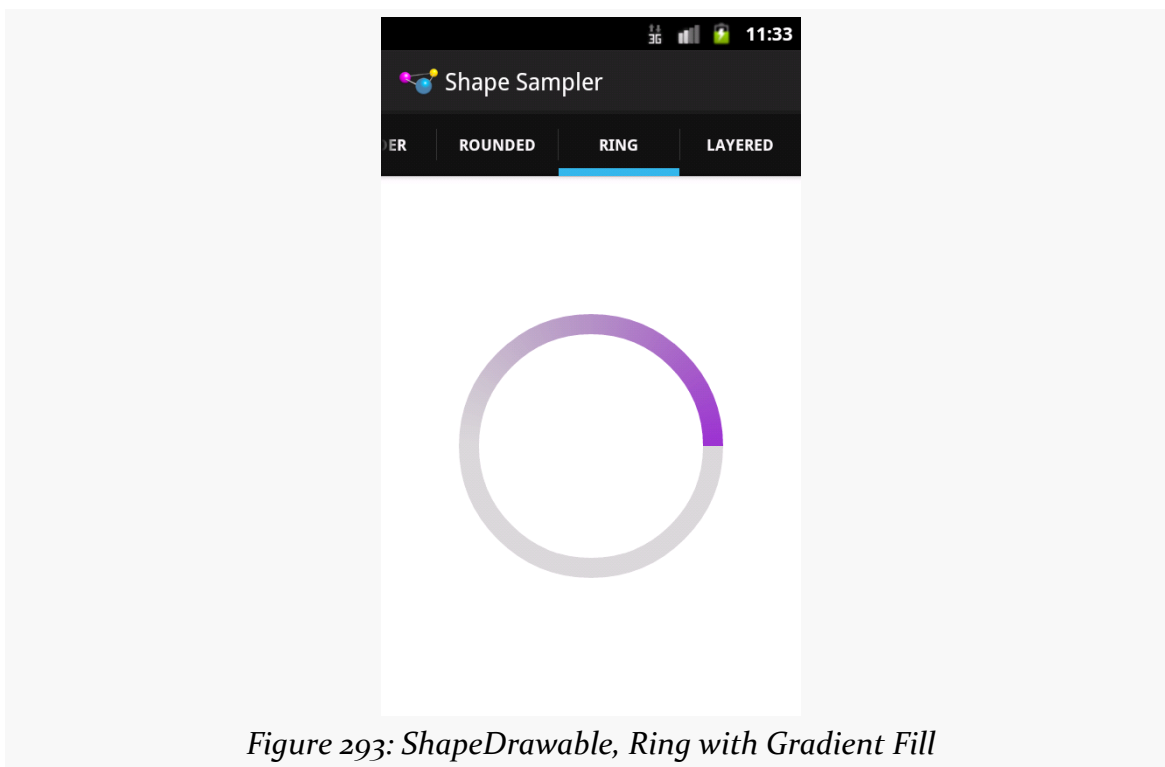
</shape>
```

Here, we:

- Declare that our shape is a `ring`
- Indicate that the distance between the inner radius and the outer radius of the ring should be `15dp`
- Indicate that there is a `3:1` ratio between the width of the image and the radius of the “hole” in the ring
- Indicate that the fill should be a gradient that sweeps clockwise from the default angle of `0`
- Indicate that the first half of the gradient (start to center) should remain a constant color
- Indicate that the second half of the gradient (center to end) should change color from gray to purple

We also have `android:useLevel="false"` in the `<shape>` element. For unknown reasons, this is required for rings but not for other types of shapes.

This gives us:



*Figure 293: ShapeDrawable, Ring with Gradient Fill*

## Composite Drawables

Let's say that we wanted to have a pair of ShapeDrawable images, one superimposed on another. Since a single ShapeDrawable defines only one shape, we would need something else to assist with stacking the images.

One possibility would be to use a LayerDrawable, creating three total resources:

1. The first ShapeDrawable, in its own resource file
2. The second ShapeDrawable, in its own resource file
3. The LayerDrawable, holding references to the two ShapeDrawable resources

And this will certainly work. But you have an alternative: put all of it into a single drawable resource.

An `android:drawable` attribute in an `<item>` element can be replaced by child elements representing another drawable structure. Hence, rather than having a



## CUSTOM DRAWABLES

---

LayerDrawable with two `<item>` elements pointing to other drawable resources, we could have those same `<item>` elements *contain* the other drawable XML structures, and thereby cut our number of files from 3 to 1.

For example, we could have something like this:

```
<?xml version="1.0" encoding="utf-8"?>
<layer-list xmlns:android="http://schemas.android.com/apk/res/android">

  <item>
    <shape android:shape="rectangle">
      <gradient
        android:angle="270"
        android:endColor="#FF0000FF"
        android:startColor="#FFFF0000" />

      <stroke
        android:dashGap="4dp"
        android:dashWidth="20dp"
        android:width="2dp"
        android:color="#FF000000" />

      <corners android:radius="8dp" />
    </shape>
  </item>
  <item>
    <shape
      android:innerRadiusRatio="3"
      android:shape="ring"
      android:thickness="15dp"
      android:useLevel="false">
      <gradient
        android:endColor="#FFFFFFFF"
        android:startColor="#ff000000"
        android:type="sweep" />
    </shape>
  </item>
</layer-list>
```

This is a LayerDrawable, layering two ShapeDrawable structures. The first ShapeDrawable is our dash-bordered, gradient-filled, rounded rectangle from before. The second ShapeDrawable is a ring with a simple gradient sweep fill, from black to white.

This gives us:

## CUSTOM DRAWABLES

---

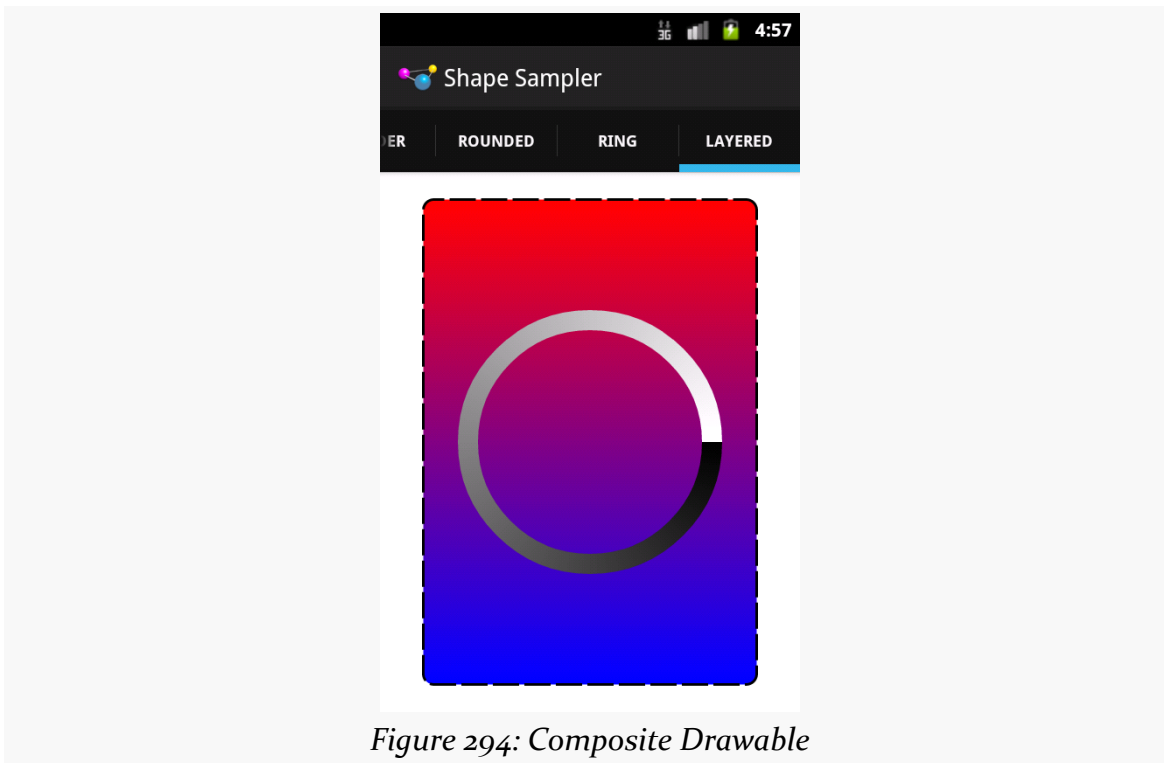


Figure 294: Composite Drawable

Hence, any of the drawable XML structures other than ShapeDrawable can, in their `<item>` elements, hold any drawable XML structure, instead of pointing to another separate resource.

Android uses this trick as well. For example, the stock ProgressBar image is based off of a LayerDrawable wrapped around three ShapeDrawable structures:

```
<?xml version="1.0" encoding="utf-8"?>
<!-- Copyright (C) 2008 The Android Open Source Project

Licensed under the Apache License, Version 2.0 (the "License");
you may not use this file except in compliance with the License.
You may obtain a copy of the License at

    http://www.apache.org/licenses/LICENSE-2.0

Unless required by applicable law or agreed to in writing, software
distributed under the License is distributed on an "AS IS" BASIS,
WITHOUT WARRANTIES OR CONDITIONS OF ANY KIND, either express or implied.
See the License for the specific language governing permissions and
limitations under the License.
-->
<layer-list xmlns:android="http://schemas.android.com/apk/res/android">
```

```
<item android:id="@android:id/background">
  <shape>
    <corners android:radius="5dip" />
    <gradient
      android:startColor="#ff9d9e9d"
      android:centerColor="#ff5a5d5a"
      android:centerY="0.75"
      android:endColor="#ff747674"
      android:angle="270"
    />
  </shape>
</item>

<item android:id="@android:id/secondaryProgress">
  <clip>
    <shape>
      <corners android:radius="5dip" />
      <gradient
        android:startColor="#80ffd300"
        android:centerColor="#80ffb600"
        android:centerY="0.75"
        android:endColor="#a0ffc000"
        android:angle="270"
      />
    </shape>
  </clip>
</item>

<item android:id="@android:id/progress">
  <clip>
    <shape>
      <corners android:radius="5dip" />
      <gradient
        android:startColor="#ffffd300"
        android:centerColor="#ffffb600"
        android:centerY="0.75"
        android:endColor="#ffffc000"
        android:angle="270"
      />
    </shape>
  </clip>
</item>
</layer-list>
```

We will get into how this works with a ProgressBar in [a separate chapter](#).

## XML Drawables and Eclipse

Alas, Eclipse has no special support for these drawables. When you double-click on one in the Package Explorer, you will get a standard XML editor, nothing more, at least at the present time.

## A Stitch In Time Saves Nine

Most of the types of non-traditional drawable resources you can create in Android are described in XML... but not all.

As you read through the Android documentation, you no doubt ran into references to “nine-patch” or “9-patch” and wondered what Android had to do with [quilting](#). Rest assured, you will not need to take up needlework to be an effective Android developer.

If, however, you are looking to create backgrounds for resizable widgets, like a Button, you may wish to work with nine-patch images.

As the Android documentation states, a nine-patch is “a PNG image in which you define stretchable sections that Android will resize to fit the object at display time to accommodate variable sized sections, such as text strings”. By using a specially-created PNG file, Android can avoid trying to use vector-based formats (e.g., ShapeDrawable) and their associated overhead when trying to create a background at runtime. Yet, at the same time, Android can still resize the background to handle whatever you want to put inside of it, such as the text of a Button.

In this section, we will cover some of the basics of nine-patch graphics, including how to customize and apply them to your own Android layouts.

### The Name and the Border

Nine-patch graphics are PNG files whose names end in `.9.png`. This means they can be edited using normal graphics tools, but Android knows to apply nine-patch rules to their use.

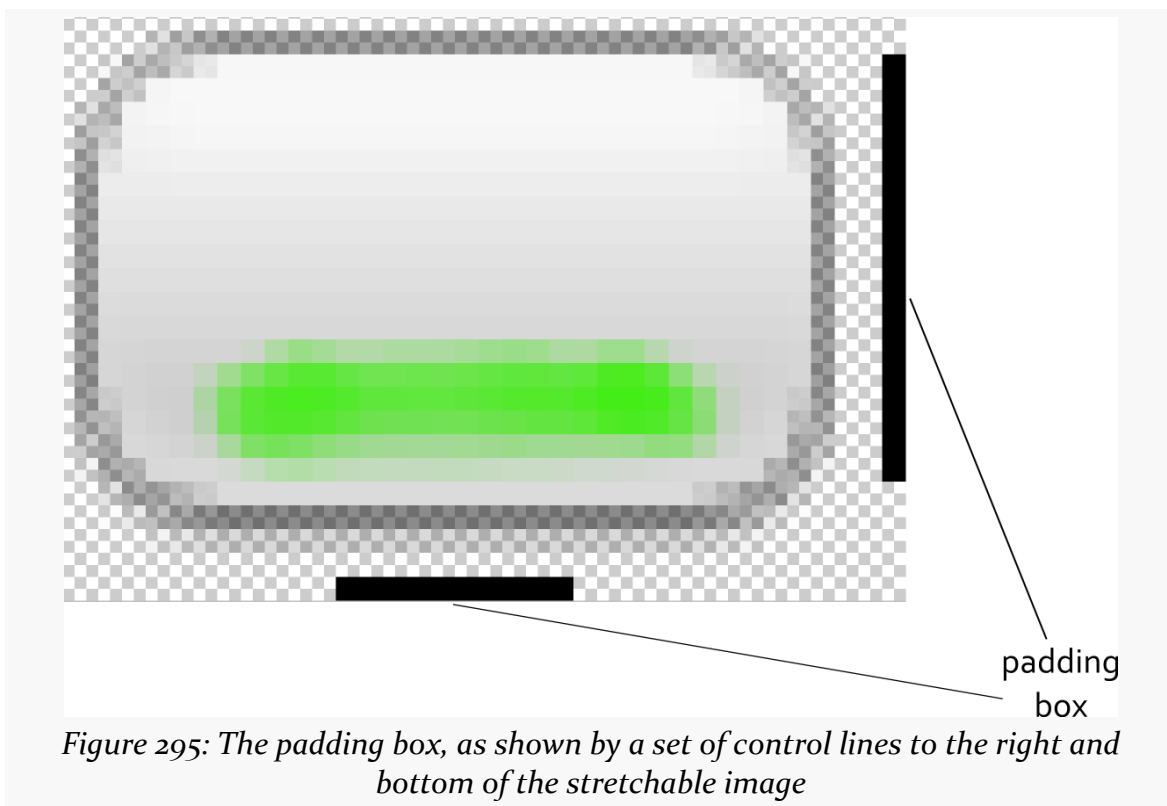
What makes a nine-patch graphic different than an ordinary PNG is a one-pixel-wide border surrounding the image. When drawn, Android will remove that border, showing only the stretched rendition of what lies inside the border. The border is

used as a control channel, providing instructions to Android for how to deal with stretching the image to fit its contents.

## Padding and the Box

Along the right and bottom sides, you can draw one-pixel-wide black lines to indicate the “padding box”. Android will stretch the image such that the contents of the widget will fit inside that padding box.

For example, suppose we are using a nine-patch as the background of a Button. When you set the text to appear in the button (e.g., “Hello, world!”), Android will compute the size of that text, in terms of width and height in pixels. Then, it will stretch the nine-patch image such that the text will reside inside the padding box. What lies outside the padding box forms the border of the button, typically a rounded rectangle of some form.

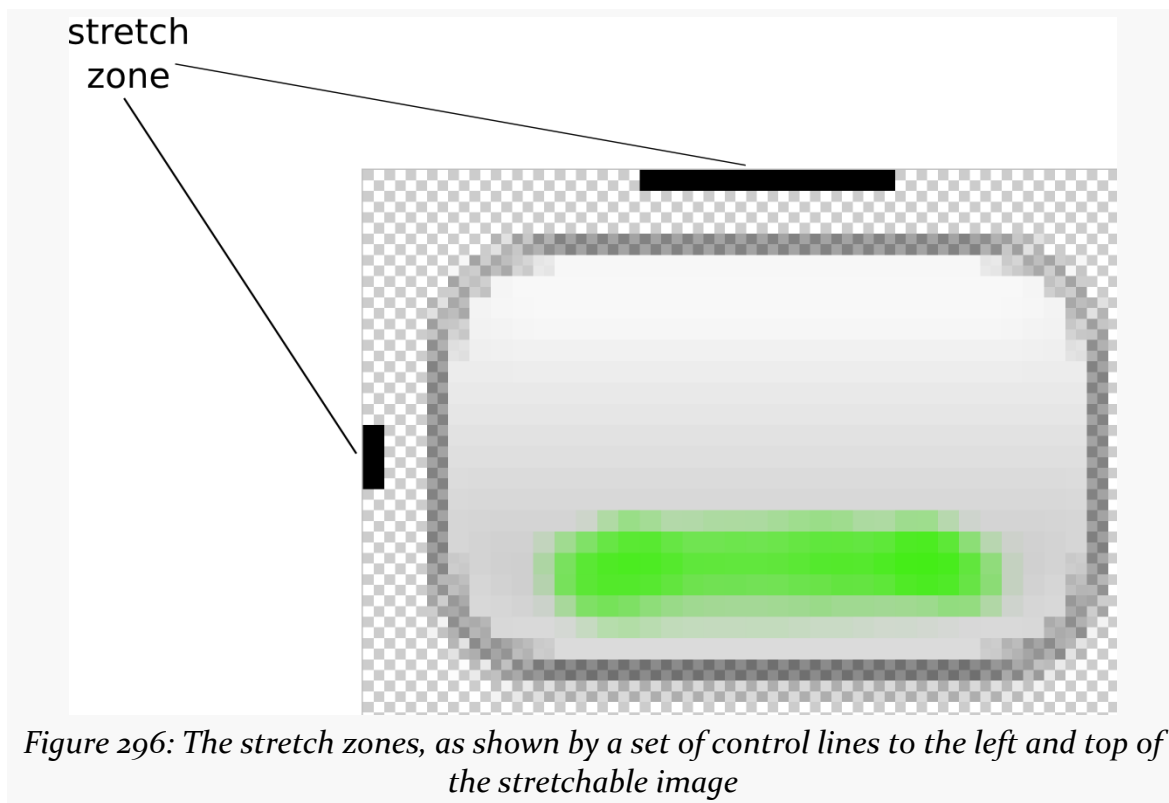


*Figure 295: The padding box, as shown by a set of control lines to the right and bottom of the stretchable image*

## Stretch Zones

To tell Android where on the image to actually do the stretching, draw one-pixel-wide black lines on the top and left sides of the image. Android will scale the graphic only in those areas — areas outside the stretch zones are not stretched.

Perhaps the most common pattern is the center-stretch, where the middle portions of the image on both axes are considered stretchable, but the edges are not:



*Figure 296: The stretch zones, as shown by a set of control lines to the left and top of the stretchable image*

Here, the stretch zones will be stretched just enough for the contents to fit in the padding box. The edges of the graphic are left unstretched.

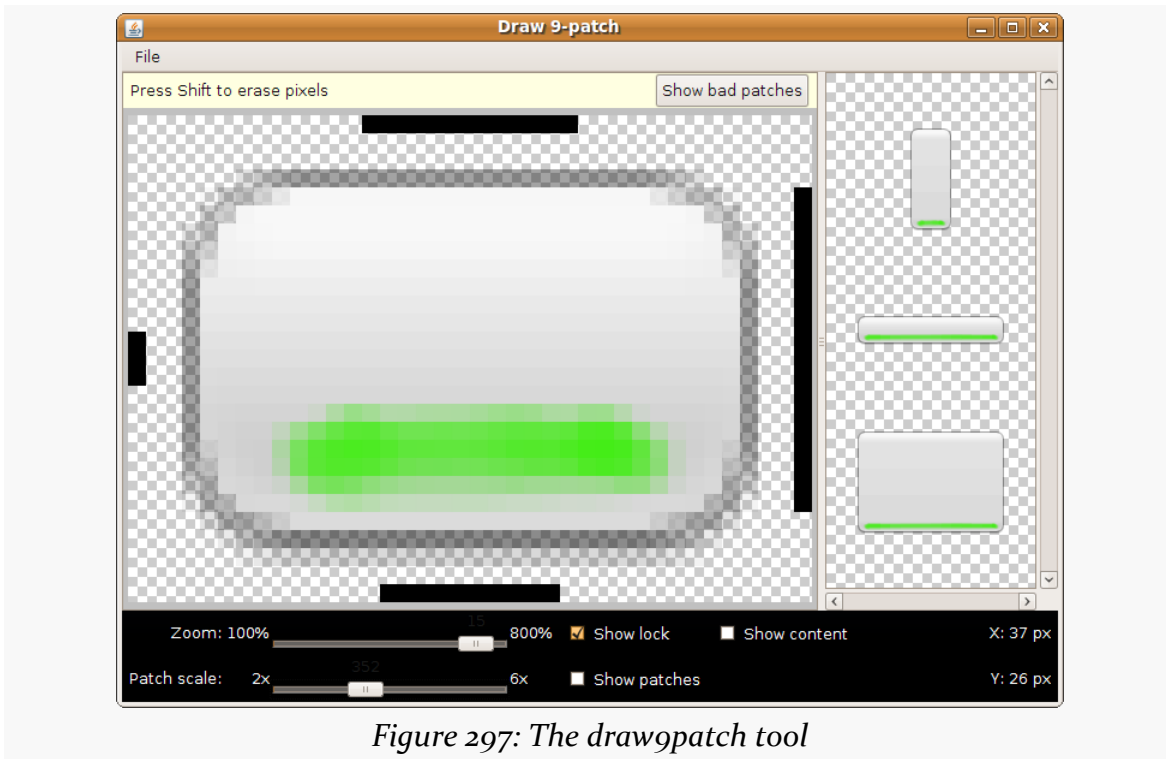
Some additional rules to bear in mind:

1. If you have multiple discrete stretch zones along an axis (e.g., two zones separated by whitespace), Android will stretch both of them but keep them in their current proportions. So, if the first zone is twice as wide as the second zone in the original graphic, the first zone will be twice as wide as the second zone in the stretched graphic.

2. If you leave out the control lines for the padding box, it is assumed that the padding box and the stretch zones are one and the same.

### Tooling

To experiment with nine-patch images, you may wish to use the `draw9patch` program, found in the `tools/` directory of your SDK installation:



*Figure 297: The draw9patch tool*

Eclipse, at the present time, does not have a built-in version of `draw9patch`, so Eclipse users will need to run the standalone copy from their SDK installation.

While a regular graphics editor would allow you to draw any color on any pixel, `draw9patch` limits you to drawing or erasing pixels in the control area. If you attempt to draw inside the main image area itself, you will be blocked.

On the right, you will see samples of the image in various stretched sizes, so you can see the impact as you change the stretchable zones and padding box.

While this is convenient for working with the nine-patch nature of the image, you will still need some other graphics editor to create or modify the body of the image

itself. For example, the image shown above, from the Drawable/NinePatch project, is a modified version of a nine-patch graphic from the SDK's ApiDemos, where the GIMP was used to add the neon green stripe across the bottom portion of the image.

### Using Nine-Patch Images

Nine-patch images are most commonly used as backgrounds, as illustrated by the following layout from the [Drawable/NinePatch](#) sample project:

```
<?xml version="1.0" encoding="utf-8"?>
<LinearLayout xmlns:android="http://schemas.android.com/apk/res/android"
    android:orientation="vertical"
    android:layout_width="match_parent"
    android:layout_height="match_parent"
    >
    <TableLayout
        android:layout_width="match_parent"
        android:layout_height="wrap_content"
        android:stretchColumns="1"
    >
        <TableRow
            android:layout_width="match_parent"
            android:layout_height="wrap_content"
        >
            <TextView
                android:layout_width="wrap_content"
                android:layout_height="wrap_content"
                android:layout_gravity="center_vertical"
                android:text="Horizontal:"
            />
            <SeekBar android:id="@+id/horizontal"
                android:layout_width="match_parent"
                android:layout_height="wrap_content"
            />
        </TableRow>
        <TableRow
            android:layout_width="match_parent"
            android:layout_height="wrap_content"
        >
            <TextView
                android:layout_width="wrap_content"
                android:layout_height="wrap_content"
                android:layout_gravity="center_vertical"
                android:text="Vertical:"
            />
            <SeekBar android:id="@+id/vertical"
                android:layout_width="match_parent"
                android:layout_height="wrap_content"
            />
        </TableRow>
    </TableLayout>
```



## CUSTOM DRAWABLES

---

```
<LinearLayout
  android:orientation="vertical"
  android:layout_width="match_parent"
  android:layout_height="match_parent"
  >
  <Button android:id="@+id/resize"
    android:layout_width="96px"
    android:layout_height="96px"
    android:text="Hi!"
    android:textSize="5pt"
    android:background="@drawable/button"
  />
</LinearLayout>
</LinearLayout>
```

Here, we have two SeekBar widgets, labeled for the horizontal and vertical axes, plus a Button set up with our nine-patch graphic as its background (android:background = "@drawable/button").

The NinePatchDemo activity then uses the two SeekBar widgets to let the user control how large the button should be drawn on-screen, starting from an initial size of 64px square:

```
package com.commonsware.android.ninepatch;

import android.app.Activity;
import android.os.Bundle;
import android.view.View;
import android.view.ViewGroup;
import android.widget.LinearLayout;
import android.widget.SeekBar;

public class NinePatchDemo extends Activity {
  SeekBar horizontal=null;
  SeekBar vertical=null;
  View thingToResize=null;

  @Override
  public void onCreate(Bundle savedInstanceState) {
    super.onCreate(savedInstanceState);
    setContentView(R.layout.main);

    thingToResize=findViewById(R.id.resize);

    horizontal=(SeekBar)findViewById(R.id.horizontal);
    vertical=(SeekBar)findViewById(R.id.vertical);

    horizontal.setMax(144); // 240 less 96 starting size
    vertical.setMax(144); // keep it square @ max

    horizontal.setOnSeekBarChangeListener(h);
```

## CUSTOM DRAWABLES

---

```
vertical.setOnSeekBarChangeListener(v);
}

SeekBar.OnSeekBarChangeListener h=new SeekBar.OnSeekBarChangeListener() {
    public void onProgressChanged(SeekBar seekBar,
        int progress,
        boolean fromTouch) {
        ViewGroup.LayoutParams old=thingToResize.getLayoutParams();
        ViewGroup.LayoutParams current=new LinearLayout.LayoutParams(64+progress,
            old.height);

        thingToResize.setLayoutParams(current);
    }

    public void onStartTrackingTouch(SeekBar seekBar) {
        // unused
    }

    public void onStopTrackingTouch(SeekBar seekBar) {
        // unused
    }
};

SeekBar.OnSeekBarChangeListener v=new SeekBar.OnSeekBarChangeListener() {
    public void onProgressChanged(SeekBar seekBar,
        int progress,
        boolean fromTouch) {
        ViewGroup.LayoutParams old=thingToResize.getLayoutParams();
        ViewGroup.LayoutParams current=new LinearLayout.LayoutParams(old.width,
            64+progress);

        thingToResize.setLayoutParams(current);
    }

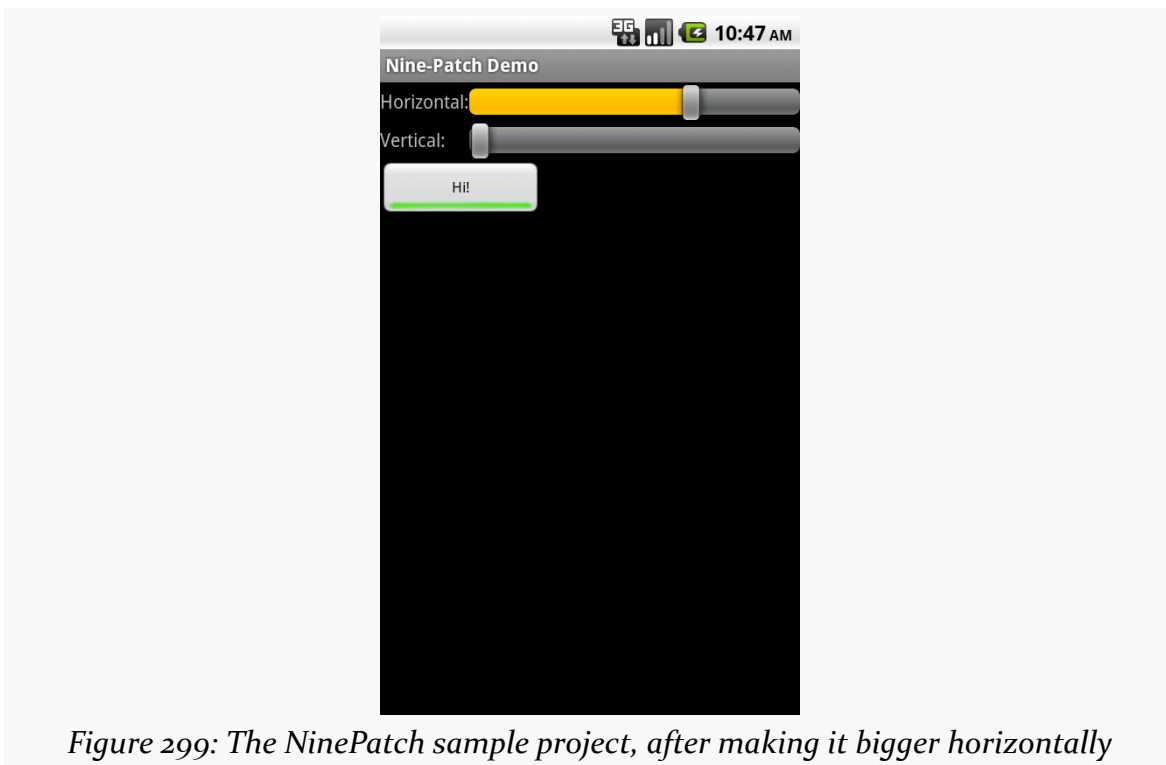
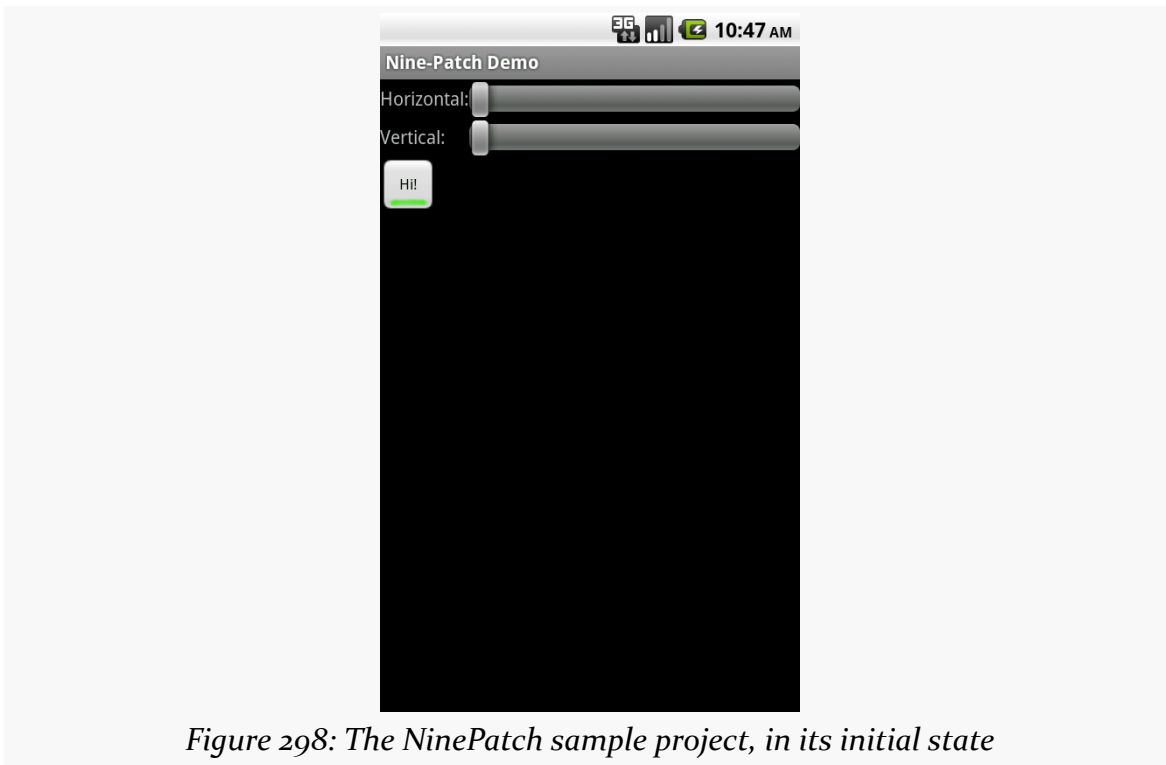
    public void onStartTrackingTouch(SeekBar seekBar) {
        // unused
    }

    public void onStopTrackingTouch(SeekBar seekBar) {
        // unused
    }
};
}
```

The result is an application that can be used much like the right pane of draw9patch, to see how the nine-patch graphic looks on an actual device or emulator in various sizes:

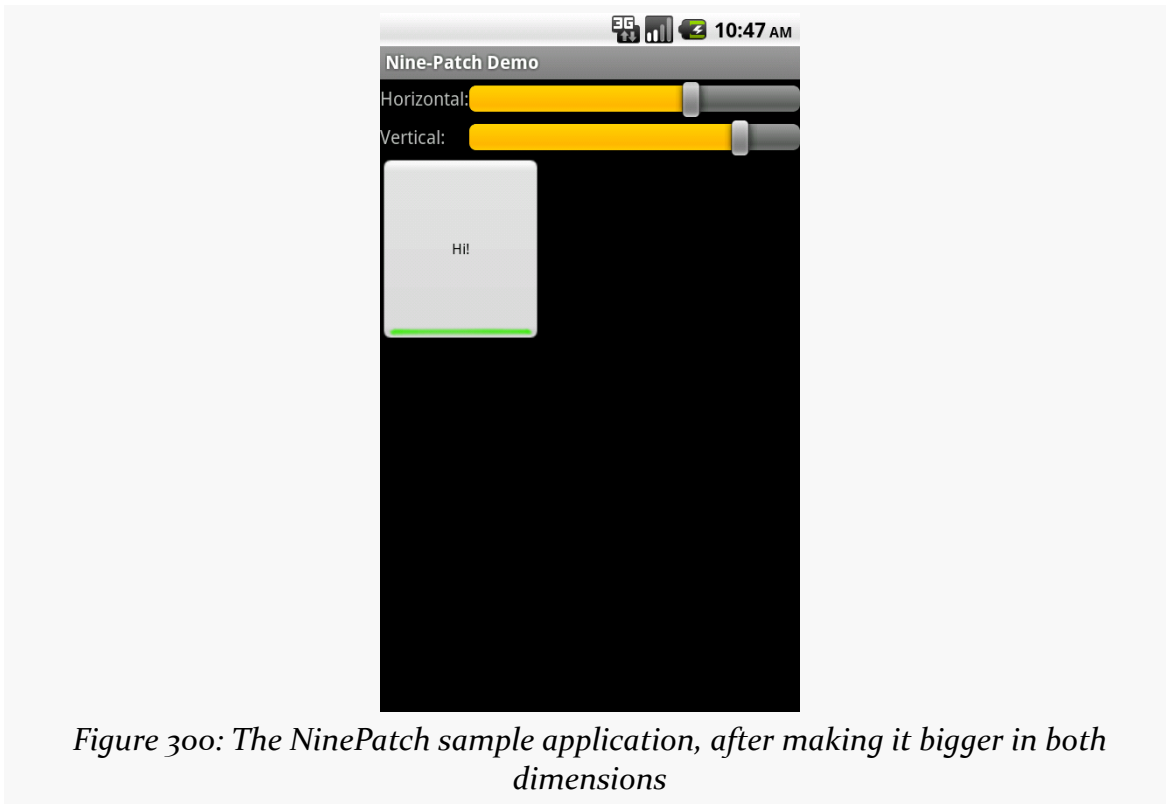
## CUSTOM DRAWABLES

---



## CUSTOM DRAWABLES

---



*Figure 300: The NinePatch sample application, after making it bigger in both dimensions*



# Animators

---

Users like things that move. Or fade, spin, or otherwise offer a dynamic experience.

Much of the time, such animations are handled for us by the framework. We do not have to worry about sliding rows in a `ListView` when the user scrolls, or as the user pans around a `ViewPager`, and so forth.

However, sometimes, we will need to add our own animations, where we want effects that either are not provided by the framework innately or are simply different (e.g., want something to slide off the bottom of the screen, rather than off the left edge).

Android had an [animation framework](#) back in the beginning, one that is still available for you today. However, Android 3.0 introduced a new *animator* framework that is going to be Android's primary focus for animated effects going forward. Many, but not all, of the animator framework capabilities are available to us as developers via a backport.

## Prerequisites

Understanding this chapter requires that you have read the core chapters of this book. Also, you should read the chapter on [custom views](#), to be able to make sense of one of the samples.

## ViewPropertyAnimator

Let's say that you want to fade out a widget, instead of simply setting its visibility to `INVISIBLE` or `GONE`.

For a widget whose name is `v`, on API Level 11 or higher, that is as simple as:

```
v.animate().alpha(0);
```

Here, “alpha” refers to the “alpha channel”. An alpha of 1 is normal opacity, while an alpha of 0 is completely transparent, with values in between representing various levels of translucence.

That may seem rather simple. The good news is, it *really* is that easy. Of course, there is a lot more you can do here, and we have to worry about supporting older Android versions, and we need to think about things other than fading widgets in and out, and so forth.

First, though, let’s consider what is really going on when we call `animate()` on a widget on API Level 11+.

### Native Implementation

The call to `animate()` returns an instance of `ViewPropertyAnimator`. This object allows us to build up a description of an animation to be performed, such as calling `alpha()` to change the alpha channel value. `ViewPropertyAnimator` uses a so-called [fluent interface](#), much like the various builder classes (e.g., `Notification.Builder`) — calling a method on a `ViewPropertyAnimator()` usually returns the `ViewPropertyAnimator` itself. This allows you to build up an animation via a chained series of method calls, starting with that call to `animate()` on the widget.

You will note that we do not end the chain of method calls with something like a `start()` method. `ViewPropertyAnimator` will automatically arrange to start the animation once we return control of the main application thread back to the framework. Hence, we do not have to explicitly start the animation.

You will also notice that we did not indicate any particulars about how the animation should be accomplished, beyond stating the ending alpha channel value of 0. `ViewPropertyAnimator` will use some standard defaults for the animation, such as a default duration, to determine how quickly Android changes the alpha value from its starting point to 0. Most of those particulars can be overridden from their defaults via additional methods called on our `ViewPropertyAnimator`, such as `setDuration()` to provide a duration in milliseconds.

There are four standard animations that `ViewPropertyAnimator` can perform:

## ANIMATORS

---

1. Changes in alpha channel values, for fading widgets in and out
2. Changes in widget position, by altering the X and Y values of the upper-left corner of the widget, from wherever on the screen it used to be to some new value
3. Changes in the widget's rotation, around any of the three axes
4. Changes in the widget's size, where Android can scale the widget by some percentage to expand or shrink it

We will see an example of changing a widget's position, using the `translationXBy()` method, [later in this chapter](#).

You are welcome to use more than one animation effect simultaneously, such as using both `alpha()` and `translationXBy()` to slide a widget horizontally and have it fade in or out.

There are other aspects of the animation that you can control. By default, the animation happens linearly — if we are sliding 500 pixels in 500ms, the widget will move evenly at 1 pixel/ms. However, you can specify a different “interpolator” to override that default linear behavior (e.g., start slow and accelerate as the animation proceeds). You can attach a listener object to find out about when the animation starts and ends. And, you can specify `withLayer()` to indicate that Android should try to more aggressively use hardware acceleration for an animation, a concept that we will get into in greater detail [later in this chapter](#).

To see this in action, take a look at the [Animation/AnimatorFade](#) sample app.

The app consists of a single activity (MainActivity). It uses a layout that is dominated by a single `TextView` widget, whose ID is `fadee`:

```
<RelativeLayout xmlns:android="http://schemas.android.com/apk/res/android"
    xmlns:tools="http://schemas.android.com/tools"
    android:layout_width="match_parent"
    android:layout_height="match_parent">

    <TextView
        android:id="@+id/fadee"
        android:layout_width="wrap_content"
        android:layout_height="wrap_content"
        android:layout_centerHorizontal="true"
        android:layout_centerVertical="true"
        android:text="@string/fading_out"
        android:textAppearance="?android:attr/textAppearanceLarge"
        tools:context=".MainActivity"/>

</RelativeLayout>
```



## ANIMATORS

---

In `onCreate()`, we load up the layout and get our hands on the `fadee` widget:

```
@Override
public void onCreate(Bundle savedInstanceState) {
    super.onCreate(savedInstanceState);
    setContentView(R.layout.activity_main);

    fadee=(TextView)findViewById(R.id.fadee);
}
```

`MainActivity` itself implements `Runnable`, and our `run()` method will perform some animated effects:

```
@Override
public void run() {
    if (fadingOut) {
        fadee.animate().alpha(0).setDuration(PERIOD);
        fadee.setText(R.string.fading_out);
    }
    else {
        fadee.animate().alpha(1).setDuration(PERIOD);
        fadee.setText(R.string.coming_back);
    }

    fadingOut=!fadingOut;

    fadee.postDelayed(this, PERIOD);
}
```

Specifically, if we are to fade out the `TextView` (as we are at the outset, we use `ViewPropertyAnimator` to fade out the widget over a certain period (`fadee.animate().alpha(0).setDuration(PERIOD);`) and set the caption of the `TextView` to a value indicating that we are fading out. If we are to be fading back in, we perform the opposite animation and set the caption to a different value. We then flip the `fadingOut` boolean for the next pass and use `postDelayed()` to reschedule ourselves to run after the period has elapsed.

To complete the process, we run() our code initially in `onResume()` and cancel the `postDelayed()` loop in `onPause()`:

```
@Override
public void onResume() {
    super.onResume();

    run();
}

@Override
public void onPause() {
```

```
fadee.removeCallbacks(this);  
  
super.onPause();  
}
```

The result is that the `TextView` smoothly fades out and in, alternating captions as it goes.

However, it would be really unpleasant if all this animator goodness worked only on API Level 11+. Fortunately for us, somebody wrote a backport... somebody with whom you are already familiar.

### Backport Via NineOldAndroids

Jake Wharton, author of `ActionBarSherlock`, `ViewPagerIndicator`, and other libraries, also wrote [NineOldAndroids](#). This is, in effect, a backport of `ViewPropertyAnimator` and its underpinnings. There are some slight changes in how you use it, because `NineOldAndroids` is simply a library. It cannot add methods to existing classes (like adding `animate()` to `View`), nor can it add capabilities that the underlying firmware simply lacks. But, it may cover many of your animator needs, even if the name is somewhat inexplicable, and it works going all the way back to API Level 1, ensuring that it will cover any Android release that you care about.

As with `ActionBarSherlock`, `NineOldAndroids` is an Android library project. You will need to download that project (look in the `library/` directory of the ZIP archive) and import it into Eclipse (if you are using Eclipse). The repository for this book has a compatible version of `NineOldAndroids` in its `external/` directory, and that version is what this chapter's samples will refer to.

Since `NineOldAndroids` cannot add `animate()` to `View`, the recommended approach is to use a somewhat obscure feature of Java: imported static methods. An `import static` statement, referencing a particular static method of a class, makes that method available as if it were a static method on the class that you are writing, or as some sort of global function. `NineOldAndroids` has an `animate()` method that you can import this way, so instead of `v.animate()`, you use `animate(v)` to accomplish the same end. Everything else is the same, except perhaps some imports, to reference `NineOldAndroids` instead of the native classes.

You can see this in the [Animation/AnimatorFadeBC](#) sample app.

In addition to having the NineOldAndroids JAR in `libs/`, the only difference between this edition and the previous sample is in how the animation is set up. Instead of lines like:

```
fadee.animate().alpha(0).setDuration(PERIOD);
```

we have:

```
animate(fadee).alpha(0).setDuration(PERIOD);
```

This takes advantage of our static import:

```
import static com.nineoldandroids.view.ViewPropertyAnimator.animate;
```

If the static import makes you queasy, you are welcome to simply import the `com.nineoldandroids.view.ViewPropertyAnimator` class, rather than the static method, and call the `animate()` method on `ViewPropertyAnimator`:

```
ViewPropertyAnimator.animate(fadee).alpha(0).setDuration(PERIOD);
```

## The Foundation: Value and Object Animators

`ViewPropertyAnimator` itself is a layer atop of a more primitive set of animators, known as value and object animators.

A `ValueAnimator` handles the core logic of transitioning some value, from an old to a new value, over a period of time. `ValueAnimator` offers replaceable “interpolators”, which will determine how the values change from start to finish over the animation period (e.g., start slowly, accelerate, then end slowly). `ValueAnimator` also handles the concept of a “repeat mode”, to indicate if the animation should simply happen once, a fixed number of times, or should infinitely repeat (and, in the latter cases, whether it does so always transitioning from start to finish or if it reverses direction on alternate passes, going from finish back to start).

What `ValueAnimator` does *not* do is actually change anything. It is merely computing the different values based on time. You can call `getAnimatedValue()` to find out the value at any point in time, or you can call `addUpdateListener()` to register a listener object that will be notified of each change in the value, so that change can be applied somewhere.

Hence, what tends to be a bit more popular is `ObjectAnimator`, a subclass of `ValueAnimator` that automatically applies the new values. `ObjectAnimator` does this

## ANIMATORS

---

by calling a setter method on some object, where you supply the object and the “property name” used to derive the getter and setter method names. For example, if you request a property name of `foo`, `ObjectAnimator` will try to call `getFoo()` and `setFoo()` methods on your supplied object.

As with `ViewPropertyAnimator`, `ValueAnimator` and `ObjectAnimator` are implemented natively in API Level 11 and are available via the `NineOldAndroids` backport as well.

To see what `ObjectAnimator` looks like in practice, let us examine the [Animation/ObjectAnimator](#) sample app.

Once again, our activity’s layout is pretty much just a centered `TextView`, here named `word`:

```
<RelativeLayout xmlns:android="http://schemas.android.com/apk/res/android"
    xmlns:tools="http://schemas.android.com/tools"
    android:layout_width="fill_parent"
    android:layout_height="fill_parent">

    <TextView
        android:id="@+id/word"
        android:layout_width="wrap_content"
        android:layout_height="wrap_content"
        android:layout_centerHorizontal="true"
        android:layout_centerVertical="true"
        android:textAppearance="?android:attr/textAppearanceLarge"
        tools:context=".MainActivity"/>

</RelativeLayout>
```

The objective of our activity is to iterate through 25 nonsense words, showing one at a time in the `TextView`:

```
package com.commonware.android animator.obj;

import android.app.Activity;
import android.os.Bundle;
import android.widget.TextView;
import com.nineoldandroids.animation.ObjectAnimator;
import com.nineoldandroids.animation.ValueAnimator;

public class MainActivity extends Activity {
    private static final String[] items= { "lorem", "ipsum", "dolor",
        "sit", "amet", "consectetuer", "adipiscing", "elit", "morbi",
        "vel", "ligula", "vitae", "arcu", "aliquet", "mollis", "etiam",
        "vel", "erat", "placerat", "ante", "porttitor", "sodales",
        "pellentesque", "augue", "purus" };
```

## ANIMATORS

---

```
private TextView word=null;
int position=0;

@Override
public void onCreate(Bundle savedInstanceState) {
    super.onCreate(savedInstanceState);
    setContentView(R.layout.activity_main);

    word=(TextView)findViewById(R.id.word);

    ValueAnimator positionAnim = ObjectAnimator.ofInt(this, "wordPosition", 0,
24);
    positionAnim.setDuration(12500);
    positionAnim.setRepeatCount(ValueAnimator.INFINITE);
    positionAnim.setRepeatMode(ValueAnimator.RESTART);
    positionAnim.start();
}

public void setWordPosition(int position) {
    this.position=position;
    word.setText(items[position]);
}

public int getWordPosition() {
    return(position);
}
}
```

To accomplish this, we use NineOldAndroids version of `ObjectAnimator`, saying that we wish to “animate” the `wordPosition` property of the activity itself, from 0 to 24. We configure the animation to run for 12.5 seconds (i.e., 500ms per word) and to repeat indefinitely by restarting the animation from the beginning on each pass. We then call `start()` to kick off the animation.

For this to work, though, we need `getWordPosition()` and `setWordPosition()` accessor methods for the theoretical `wordPosition` property. In our case, the “word position” is simply an integer data member of the activity, which we return in `getWordPosition()` and update in `setWordPosition()`. However, we also update the `TextView` in `setWordPosition()`, to display the nonsense word at that position.

The net effect is that every 500ms, a different nonsense word appears in our `TextView`.

## Hardware Acceleration

Animated effects operate much more smoothly with hardware acceleration. There are two facets to employing hardware acceleration for animations: enabling it overall and directing its use for the animations themselves.

Hardware acceleration is enabled overall on Android devices running Android 4.0 or higher (API Level 14). On Android 3.x, hardware acceleration is available but is disabled by default — use `android:hardwareAccelerated="true"` in your `<application>` or `<activity>` element in the manifest to enable it on those versions. Hardware acceleration for 2D graphics operations like widget animations is not available on older versions of Android.

While this will provide some benefit across the board, you may also wish to consider rendering animated widgets or containers in an off-screen buffer, or “hardware layer”, that then gets applied to the screen via the GPU. In particular, the GPU can apply certain animated transformations to a hardware layer without forcing software to redraw the widgets or containers (e.g., what happens when you `invalidate()` them). As it turns out, these GPU-enhanced transformations match the ones supported by `ViewPropertyAnimator`:

1. Changes in alpha channel values, for fading widgets in and out
2. Changes in widget position, by altering the X and Y values of the upper-left corner of the widget, from wherever on the screen it used to be to some new value
3. Changes in the widget’s rotation, around any of the three axes
4. Changes in the widget’s size, where Android can scale the widget by some percentage to expand or shrink it

By having the widget be rendered in a hardware layer, these `ViewPropertyAnimator` operations are significantly more efficient than before.

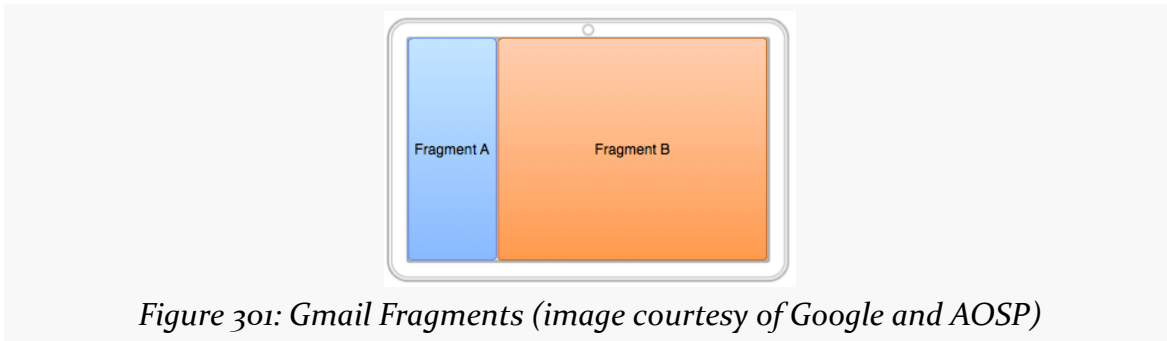
However, since hardware layers take up video memory, generally you do not want to keep a widget or container in a hardware layer indefinitely. Instead, the recommended approach is to have the widget or container be rendered in a hardware layer only while the animation is ongoing, by calling `setLayerType()` for `LAYER_TYPE_HARDWARE` before the animation begins, then calling `setLayerType()` for `LAYER_TYPE_NONE` (i.e., return to default behavior) when the animation completes. Or, for `ViewPropertyAnimator` on API Level 16 and higher, use `withLayer()` in the

fluent interface to have it apply the hardware layer automatically just for the animation duration.

We will see examples of using hardware acceleration this way in the next section.

## The Three-Fragment Problem

If you have used an Android tablet, there is a decent chance that you have used the Gmail app on that tablet. Gmail organizes its landscape main activity into two panes, one on the left taking up ~30% of the screen, and one on the right taking up the remainder:



Gmail has a very specific navigation mode in its main activity when viewed in landscape on a tablet, where upon some UI event (e.g., tapping on something in the right-hand area):

- The original left-hand fragment (Fragment A) slides off the screen to the left
- The original right-hand fragment (Fragment B) slides to the left edge of the screen and shrinks to take up the spot vacated by Fragment A
- Another fragment (Fragment C) slides in from the right side of the screen and takes up the spot vacated by Fragment B

And a BACK button press reverses this operation.

This is a bit tricky to set up, leading to the author of this book posting [a question on StackOverflow to get input](#). Here, we will examine one of the results of that discussion, based in large part on the implementation of the AOSP Email app, which has a similar navigation flow. The other answers on that question may have merit in other scenarios as well.

You can see one approach for implementing the three-pane solution in the [Animation/ThreePane](#) sample app.

### The ThreePaneLayout

The logic to handle the animated effects is encapsulated in a `ThreePaneLayout` class. It is designed to be used in a layout XML resource where you supply the contents of the three panes, sizing the first two as you want, with the third “pane” having zero width at the outset:

```
<com.commonware.android.anim.threepane.ThreePaneLayout
xmlns:android="http://schemas.android.com/apk/res/android"
  xmlns:tools="http://schemas.android.com/tools"
  android:id="@+id/root"
  android:layout_width="match_parent"
  android:layout_height="match_parent">

  <FrameLayout
    android:id="@+id/left"
    android:layout_width="0dp"
    android:layout_height="match_parent"
    android:layout_weight="3"/>

  <FrameLayout
    android:id="@+id/middle"
    android:layout_width="0dp"
    android:layout_height="match_parent"
    android:layout_weight="7"/>

  <Button
    android:layout_width="0dp"
    android:layout_height="match_parent"/>

</com.commonware.android.anim.threepane.ThreePaneLayout>
```

`ThreePaneLayout` itself is a subclass of `LinearLayout`, set up to always be horizontal, regardless of what might be set in the layout XML resource.

```
public ThreePaneLayout(Context context, AttributeSet attrs) {
    super(context, attrs);
    initSelf();
}

void initSelf() {
    setOrientation(HORIZONTAL);
}
```



## ANIMATORS

---

When the layout finishes inflating, we grab the three panes (defined as the first three children of the container) and stash them in data members named `left`, `middle`, and `right`, with matching getter methods:

```
@Override
public void onFinishInflate() {
    super.onFinishInflate();

    left=getChildAt(0);
    middle=getChildAt(1);
    right=getChildAt(2);
}

public View getLeftView() {
    return(left);
}

public View getMiddleView() {
    return(middle);
}

public View getRightView() {
    return(right);
}
```

The major operational API, from the standpoint of an activity using `ThreePaneLayout`, is `hideLeft()` and `showLeft()`. `hideLeft()` will switch from showing the left and middle widgets in their original size and position to showing the middle and right widgets wherever left and middle had been originally. `showLeft()` reverses the operation.

The problem is that, initially, we do not know where the widgets are or how big they are, as that should be able to be set from the layout XML resource and are not known until the `ThreePaneLayout` is actually applied to the screen. Hence, we lazy-retrieve those values in `hideLeft()`, plus remove any weights that had been originally defined, setting the actual pixel widths on the widgets instead:

```
public void hideLeft() {
    if (leftWidth == -1) {
        leftWidth=left.getWidth();
        middleWidthNormal=middle.getWidth();
        resetWidget(left, leftWidth);
        resetWidget(middle, middleWidthNormal);
        resetWidget(right, middleWidthNormal);
        requestLayout();
    }

    translateWidgets(-1 * leftWidth, left, middle, right);
}
```

## ANIMATORS

---

```
ObjectAnimator.ofInt(this, "middleWidth", middleWidthNormal,  
                    leftWidth).setDuration(ANIM_DURATION).start();  
}
```

The work to change the weights into widths is handled in `resetWidget()`:

```
private void resetWidget(View v, int width) {  
    LinearLayout.LayoutParams p=  
        (LinearLayout.LayoutParams)v.getLayoutParams();  
  
    p.width=width;  
    p.weight=0;  
}
```

After the lazy-initialization and widget cleanup, we perform the two animations. `translateWidgets()` will slide each of our three widgets to the left by the width of the left widget, using a `ViewPropertyAnimator` and a hardware layer:

```
private void translateWidgets(int deltaX, View... views) {  
    for (final View v : views) {  
        v.setLayerType(View.LAYER_TYPE_HARDWARE, null);  
  
        v.animate().translationXBy(deltaX).setDuration(ANIM_DURATION)  
            .setListener(new AnimatorListenerAdapter() {  
                @Override  
                public void onAnimationEnd(Animator animation) {  
                    v.setLayerType(View.LAYER_TYPE_NONE, null);  
                }  
            });  
    }  
}
```

The resize animation — to set the middle size to be what left had been — is handled via an `ObjectAnimator`, for a theoretical property of `middleWidth` on `ThreePaneLayout`. That is backed by a `setMiddleWidth()` method that adjusts the width property of the middle widget's `LayoutParams` and triggers a redraw:

```
@SuppressWarnings("unused")  
private void setMiddleWidth(int value) {  
    middle.getLayoutParams().width=value;  
    requestLayout();  
}
```

The `showLeft()` method simply performs those two animations in reverse:

```
public void showLeft() {  
    translateWidgets(leftWidth, left, middle, right);  
  
    ObjectAnimator.ofInt(this, "middleWidth", leftWidth,
```

```
        middleWidthNormal).setDuration(ANIM_DURATION)
        .start();
    }
```

## Using the ThreePaneLayout

The sample app uses one activity (MainActivity) and one fragment (SimpleListFragment) to set up and use the ThreePaneLayout. The objective is a UI that roughly mirrors that of Gmail and the AOSP Email app: a list on the left, a list in the middle (whose contents are based on the item chosen in the left list), and something else on the right (whose contents are based on the item chosen in the middle list).

SimpleListFragment is used for both lists. Its newInstance() factory method is handed the list of strings to display. SimpleListFragment just loads those into its ListView, also setting up CHOICE\_MODE\_SINGLE for use with the activated style, and routing all clicks on the list to the MainActivity that hosts the fragment:

```
package com.commonware.android.anim.threepane;

import android.app.ListFragment;
import android.os.Bundle;
import android.view.View;
import android.widget.AdapterView;
import android.widget.AdapterView.OnItemClickListener;
import android.widget.ListView;
import java.util.ArrayList;
import java.util.Arrays;

public class SimpleListFragment extends ListFragment {
    private static final String KEY_CONTENTS="contents";

    public static SimpleListFragment newInstance(String[] contents) {
        return(new SimpleListFragment(new ArrayList<String>(Arrays.asList(contents))));
    }

    public static SimpleListFragment newInstance(ArrayList<String> contents) {
        SimpleListFragment result=new SimpleListFragment();
        Bundle args=new Bundle();

        args.putStringArrayList(KEY_CONTENTS, contents);
        result.setArguments(args);

        return(result);
    }

    @Override
    public void onActivityCreated(Bundle savedInstanceState) {
        super.onActivityCreated(savedInstanceState);
    }
}
```

## ANIMATORS

---

```
        listView().setChoiceMode(ListView.CHOICE_MODE_SINGLE);
        setContents(getArguments().getStringArrayList(KEY_CONTENTS));
    }

    @Override
    public void onItemClick(ListView l, View v, int position, long id) {
        ((MainActivity)getActivity()).onItemClick(this, position);
    }

    void setContents(ArrayList<String> contents) {
        setListAdapter(new ArrayAdapter<String>(
            getActivity(),
            R.layout.simple_list_item_1,
            contents));
    }
}
```

MainActivity populates the left FrameLayout with a SimpleListFragment in onCreate(), if the fragment does not already exist (e.g., from a configuration change). When an item in the left list is clicked, MainActivity populates the middle FrameLayout. When an item in the middle list is clicked, it sets the caption of the right Button and uses hideLeft() to animate that Button onto the screen, hiding the left list. If the user presses BACK, and our left list is not showing, MainActivity calls showLeft() to reverse the animation:

```
package com.commonware.android.anim.threepane;

import android.app.Activity;
import android.os.Bundle;
import android.widget.Button;
import java.util.ArrayList;

public class MainActivity extends Activity {
    private static final String KEY_MIDDLE_CONTENTS="middleContents";
    private static final String[] items= { "lorem", "ipsum", "dolor",
        "sit", "amet", "consectetuer", "adipiscing", "elit", "morbi",
        "vel", "ligula", "vitae", "arcu", "aliquet", "mollis", "etiam",
        "vel", "erat", "placerat", "ante", "porttitor", "sodales",
        "pellentesque", "augue", "purus" };
    private boolean isLeftShowing=true;
    private SimpleListFragment middleFragment=null;
    private ArrayList<String> middleContents=null;
    private ThreePaneLayout root=null;

    @Override
    public void onCreate(Bundle savedInstanceState) {
        super.onCreate(savedInstanceState);
        setContentView(R.layout.activity_main);

        root=(ThreePaneLayout)findViewById(R.id.root);
    }
}
```

## ANIMATORS

---

```
if (getFragmentManager().findFragmentById(R.id.left) == null) {
    getFragmentManager().beginTransaction()
        .add(R.id.left,
            SimpleListFragment.newInstance(items))
        .commit();
}

middleFragment=
    (SimpleListFragment)getFragmentManager().findFragmentById(R.id.middle);
}

@Override
public void onBackPressed() {
    if (!isLeftShowing) {
        root.showLeft();
        isLeftShowing=true;
    }
    else {
        super.onBackPressed();
    }
}

@Override
protected void onSaveInstanceState(Bundle outState) {
    super.onSaveInstanceState(outState);

    outState.putStringArrayList(KEY_MIDDLE_CONTENTS, middleContents);
}

@Override
protected void onRestoreInstanceState(Bundle inState) {
    middleContents=inState.getStringArrayList(KEY_MIDDLE_CONTENTS);
}

void onItemClick(SimpleListFragment fragment, int position) {
    if (fragment == middleFragment) {
        ((Button)root.getRightView()).setText(middleContents.get(position));

        if (isLeftShowing) {
            root.hideLeft();
            isLeftShowing=false;
        }
    }
    else {
        middleContents=new ArrayList<String>();

        for (int i=0; i < 20; i++) {
            middleContents.add(items[position] + " #" + i);
        }

        if (getFragmentManager().findFragmentById(R.id.middle) == null) {
            middleFragment=SimpleListFragment.newInstance(middleContents);
            getFragmentManager().beginTransaction()
                .add(R.id.middle, middleFragment).commit();
        }
    }
}
```

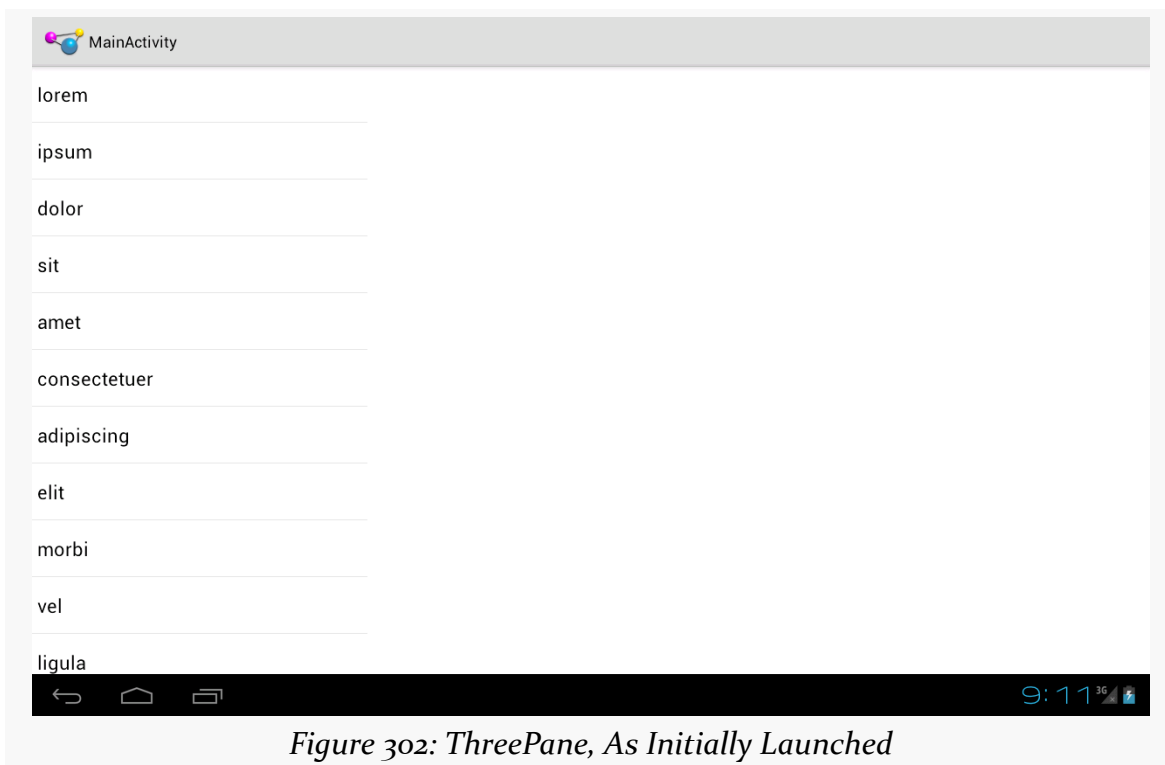
## ANIMATORS

---

```
    }  
    else {  
        middleFragment.setContentViews(middleContents);  
    }  
}  
}
```

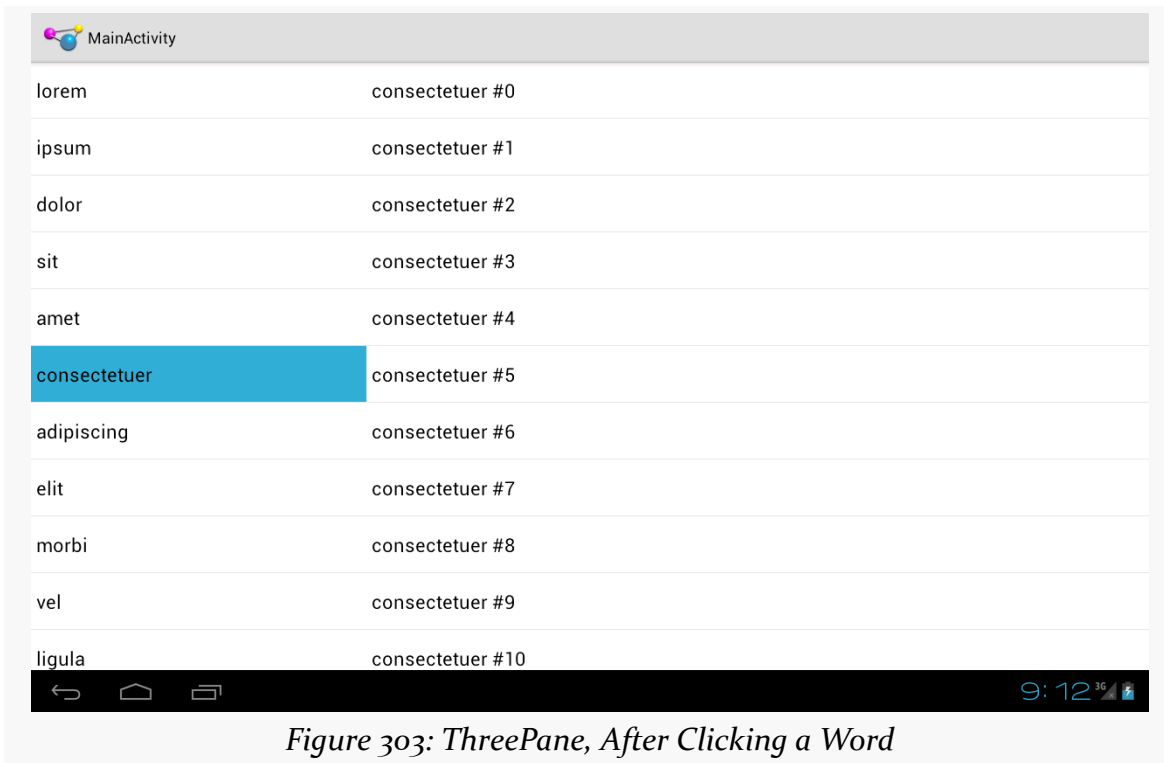
### The Results

If you run this app on a landscape tablet running API Level 11 or higher, you start off with a single list of nonsense words on the left:



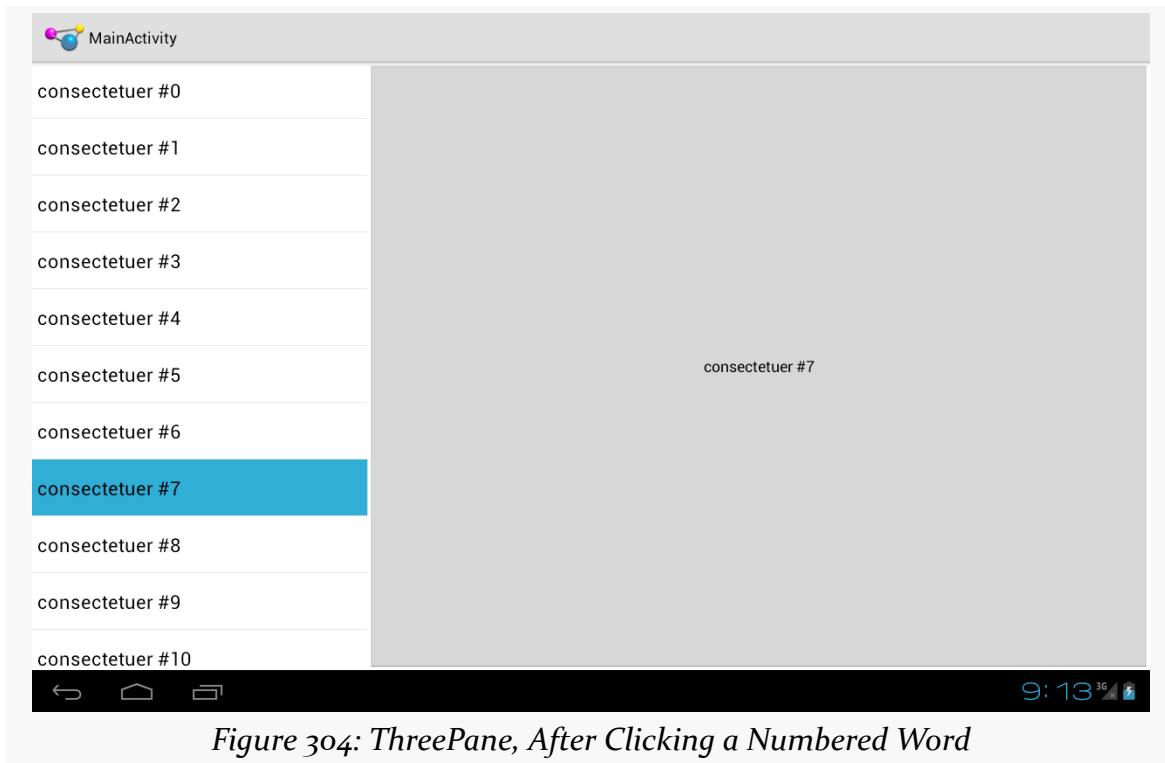
Clicking on a nonsense word brings up a second list, taking up the rest of the screen, with numbered entries based upon the clicked-upon nonsense word:

## ANIMATORS



Clicking one an entry in the second list starts the animation, sliding the first list off to the left, sliding the second list into the space vacated by the first list, and sliding in a “detail view” into the right portion of the screen:

## ANIMATORS



*Figure 304: ThreePane, After Clicking a Numbered Word*

Pressing BACK once will reverse the animation, restoring you to the two-list perspective.

### The Backport

The ThreePane sample described above uses the native API Level 11 version of the animator framework and the native implementation of fragments. However, the same approach can work using the Android Support package's version of fragments and NineOldAndroids. You can see this in the [Animation/ThreePaneBC](#) sample app.

Besides changing the import statements and adding the NineOldAndroids JAR file, the only other changes of substance were:

- Using `ViewPropertyAnimator.animate(v)` instead of `v.animate()` in `translateWidgets()`
- Conditionally setting the hardware acceleration layers via `setLayerType()` in `translateWidgets()` based upon API level, as that method was only added in API Level 11



The smoothness of animations, though, will vary by hardware capabilities. For example, on a first-generation Kindle Fire, running Android 2.3, the backport works but is not especially smooth, while the animations are very smooth on more modern hardware where hardware acceleration can be applied.

### The Problems

As we will see in [the chapter on “jank”](#), there is some stutter in the rendering of this app. Fixing it requires removing the animated change in the width of the middle pane, which in turn makes the animation itself look worse. More details on the analysis can be found in [the “jank” chapter](#).

# Legacy Animations

---

Before `ViewPropertyAnimator` and the rest of [the animator framework](#) were added in API Level 11, we had the original `Animation` base class and specialized animations based upon it, like `TranslateAnimation` for movement and `AlphaAnimation` for fades. On the whole, you will want to try to use the animator framework where possible, as the new system is more powerful and efficient than the legacy `Animation` approach. However, particularly for apps where the `NineOldAndroids` backport is insufficient, you may wish to use the legacy framework.

After an overview of the role of the [animation](#) framework, we go in-depth to animate the [movement](#) of a widget across the screen. We then look at [alpha animations](#), for fading widgets in and out. We then see how you can get control during the [lifecycle](#) of an animation, how to control the [acceleration](#) of animations, and how to [group](#) animations together for parallel execution. Finally, we see how the same framework can now be used to control the animation for the switching of [activities](#).

## Prerequisites

Understanding this chapter requires that you have read the core chapters, particularly the ones on [basic resources](#) and [basic widgets](#). Also, you should read the chapter on [custom views](#).

## It's Not Just For Toons Anymore

Android has a package of classes (`android.view.animation`) dedicated to animating the movement and behavior of widgets.

They center around an `Animation` base class that describes what is to be done. Built-in animations exist to move a widget (`TranslateAnimation`), change the transparency of a widget (`AlphaAnimation`), revolve a widget (`RotateAnimation`), and resize a widget (`ScaleAnimation`). There is even a way to aggregate animations together into a composite `Animation` called an `AnimationSet`. Later sections in this chapter will examine the use of several of these animations.

Given that you have an animation, to apply it, you have two main options:

1. You may be using a container that supports animating its contents, such as a `ViewFlipper` or `TextSwitcher`. These are typically subclasses of `ViewAnimator` and let you define the “in” and “out” animations to apply. For example, with a `ViewFlipper`, you can specify how it flips between `Views` in terms of what animation is used to animate “out” the currently-visible `View` and what animation is used to animate “in” the replacement `View`.
2. You can simply tell any `View` to `startAnimation()`, given the `Animation` to apply to itself. This is the technique we will be seeing used in the examples in this chapter.

## A Quirky Translation

Animation takes some getting used to. Frequently, it takes a fair bit of experimentation to get it all working as you wish. This is particularly true of `TranslateAnimation`, as not everything about it is intuitive, even to authors of Android books.

### Mechanics of Translation

The simple constructor for `TranslateAnimation` takes four parameters describing how the widget should move: the before and after `X` offsets from the current position, and the before and after `Y` offsets from the current position. The Android documentation refers to these as `fromXDelta`, `toXDelta`, `fromYDelta`, and `toYDelta`.

In Android’s pixel-space, an  $(X, Y)$  coordinate of  $(0, 0)$  represents the upper-left corner of the screen. Hence, if `toXDelta` is greater than `fromXDelta`, the widget will move to the right, if `toYDelta` is greater than `fromYDelta`, the widget will move down, and so on.

### Imagining a Sliding Panel

Some Android applications employ a sliding panel, one that is off-screen most of the time but can be called up by the user (e.g., via a menu) when desired. When anchored at the bottom of the screen, the effect is akin to the Android menu system, with a container that slides up from the bottom and slides down and out when being removed. However, while menus are limited to menu choices, Android's animation framework lets one create a sliding panel containing whatever widgets you might want.

One way to implement such a panel is to have a container (e.g., a `LinearLayout`) whose contents are absent (`INVISIBLE`) when the panel is closed and is present (`VISIBLE`) when the drawer is open. If we simply toggled `setVisibility()` using the aforementioned values, though, the panel would wink open and closed immediately, without any sort of animation. So, instead, we want to:

1. Make the panel visible and animate it up from the bottom of the screen when we open the panel
2. Animate it down to the bottom of the screen and make the panel invisible when we close the panel

### The Aftermath

This brings up a key point with respect to `TranslateAnimation`: the animation temporarily moves the widget, but if you want the widget to stay where it is when the animation is over, you have to handle that yourself. Otherwise, the widget will snap back to its original position when the animation completes.

In the case of the panel opening, we handle that via the transition from `INVISIBLE` to `VISIBLE`. Technically speaking, the panel is always “open”, in that we are not, in the end, changing its position. But when the body of the panel is `INVISIBLE`, it takes up no space on the screen; when we make it `VISIBLE`, it takes up whatever space it is supposed to.

Later in this chapter, we will cover how to use animation listeners to accomplish this end for closing the panel.

### Introducing SlidingPanel

With all that said, turn your attention to the [Animation/SlidingPanel](#) sample project and, in particular, the `SlidingPanel` class.

This class implements a layout that works as a panel, anchored to the bottom of the screen. A `toggle()` method can be called by the activity to hide or show the panel. The panel itself is a `LinearLayout`, so you can put whatever contents you want in there.

We use two flavors of `TranslateAnimation`, one for opening the panel and one for closing it.

Here is the opening animation:

```
anim=new TranslateAnimation(0.0f, 0.0f,  
                           getHeight(),  
                           0.0f);
```

Our `fromXDelta` and `toXDelta` are both 0, since we are not shifting the panel's position along the horizontal axis. Our `fromYDelta` is the panel's height according to its layout parameters (representing how big we want the panel to be), because we want the panel to start the animation at the bottom of the screen; our `toYDelta` is 0 because we want the panel to be at its "natural" open position at the end of the animation.

Conversely, here is the closing animation:

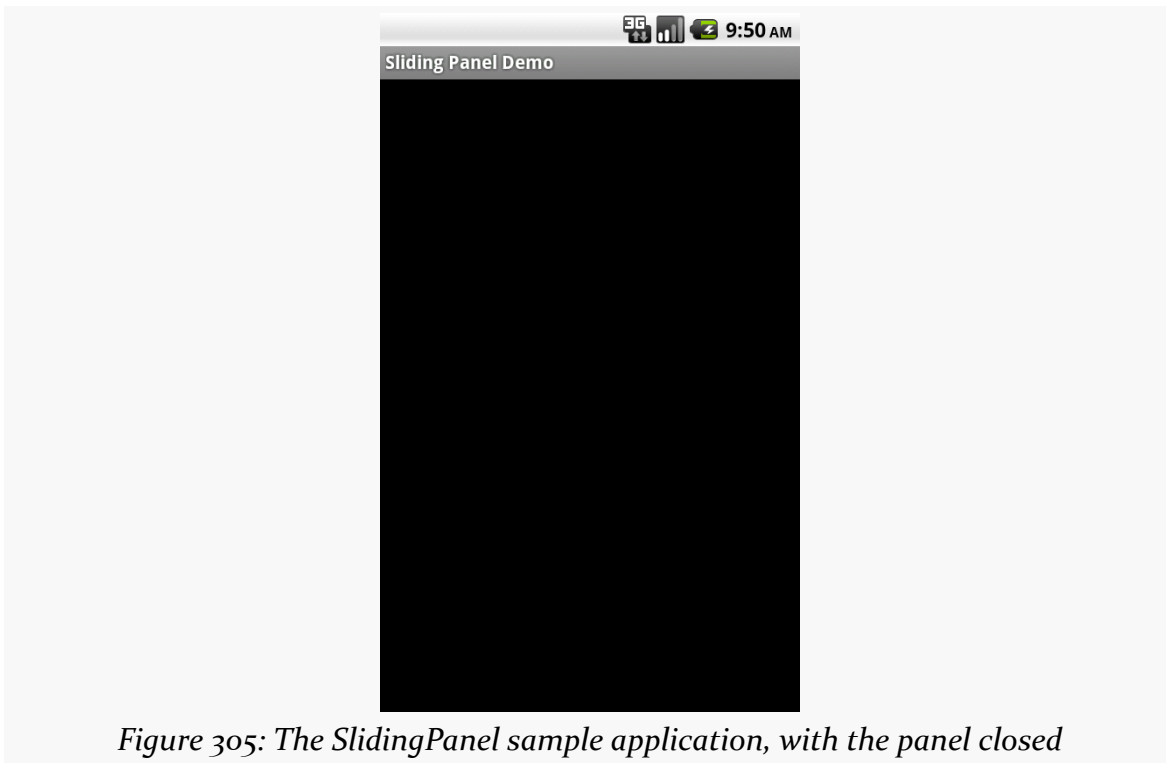
```
anim=new TranslateAnimation(0.0f, 0.0f, 0.0f,  
                           getHeight());
```

It has the same basic structure, except the Y values are reversed, since we want the panel to start open and animate to a closed position.

The result is a container that can be closed:

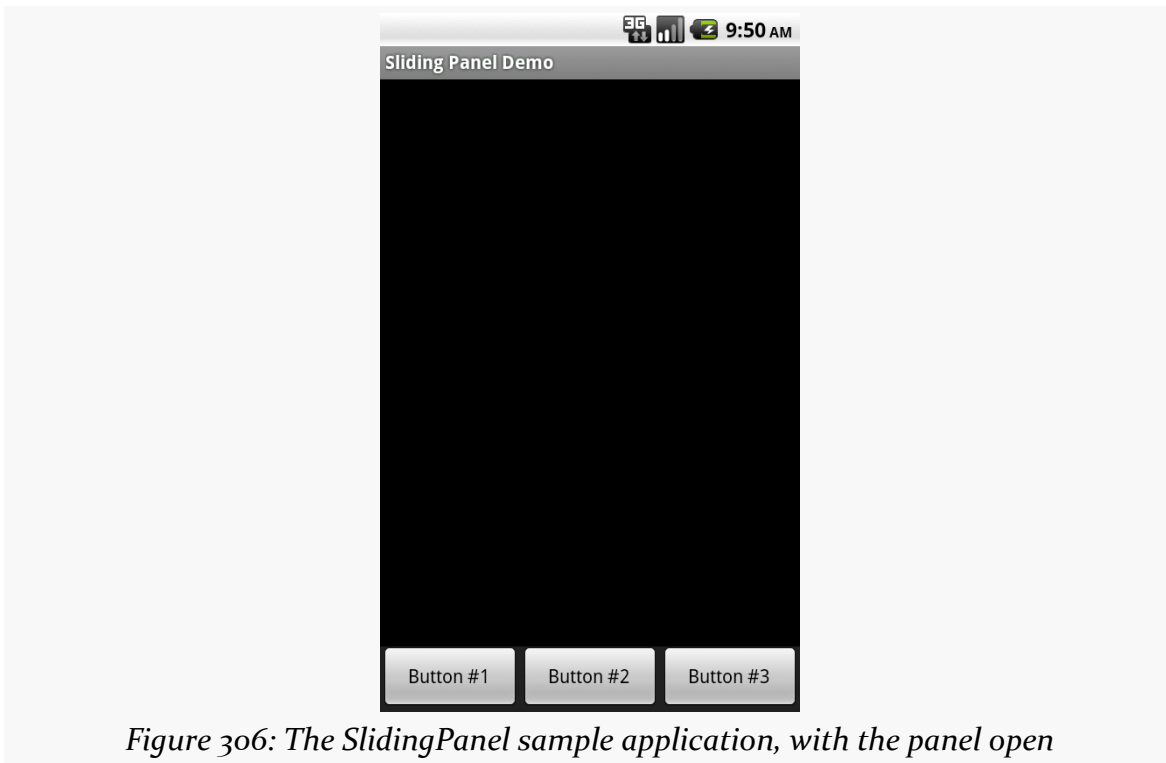
## LEGACY ANIMATIONS

---



*Figure 305: The SlidingPanel sample application, with the panel closed*

... or open, in this case toggled via a menu choice in the SlidingPanelDemo activity:



*Figure 306: The SlidingPanel sample application, with the panel open*

### Using the Animation

When setting up an animation, you also need to indicate how long the animation should take. This is done by calling `setDuration()` on the animation, providing the desired length of time in milliseconds.

When we are ready with the animation, we simply call `startAnimation()` on the `SlidingPanel` itself, causing it to move as specified by the `TranslateAnimation` instance.

### Fading To Black. Or Some Other Color.

`AlphaAnimation` allows you to fade a widget in or out by making it less or more transparent. The greater the transparency, the more the widget appears to be “fading”.

### Alpha Numbers

You may be used to alpha channels, when used in #AARRGGBB color notation, or perhaps when working with alpha-capable image formats like PNG.

Similarly, `AlphaAnimation` allows you to change the alpha channel for an entire widget, from fully-solid to fully-transparent.

In Android, a float value of 1.0 indicates a fully-solid widget, while a value of 0.0 indicates a fully-transparent widget. Values in between, of course, represent various amounts of transparency.

Hence, it is common for an `AlphaAnimation` to either start at 1.0 and smoothly change the alpha to 0.0 (a fade) or vice versa.

### Animations in XML

With `TranslateAnimation`, we showed how to construct the animation in Java source code. One can also create animation resources, which define the animations using XML. This is similar to the process for defining layouts, albeit much simpler.

For example, there is a second animation project, [Animation/SlidingPanelEx](#), which demonstrates a panel that fades out as it is closed. In there, you will find a `res/anim/` directory, which is where animation resources should reside. In there, you will find `fade.xml`:

```
<?xml version="1.0" encoding="utf-8"?>
<alpha xmlns:android="http://schemas.android.com/apk/res/android"
    android:fromAlpha="1.0"
    android:toAlpha="0.0" />
```

The name of the root element indicates the type of animation (in this case, alpha for an `AlphaAnimation`). The attributes specify the characteristics of the animation, in this case a fade from 1.0 to 0.0 on the alpha channel.

This XML is the same as calling `new AlphaAnimation(1.0f,0.0f)` in Java.

### Using XML Animations

To make use of XML-defined animations, you need to inflate them, much as you might inflate a `View` or `Menu` resource. This is accomplished by using the



## LEGACY ANIMATIONS

---

`loadAnimation()` static method on the `AnimationUtils` class, seen here in our `SlidingPanel` constructor:

```
public SlidingPanel(final Context ctxt, AttributeSet attrs) {
    super(ctxt, attrs);

    TypedArray a=ctxt.obtainStyledAttributes(attrs,
                                             R.styleable.SlidingPanel,
                                             0, 0);

    speed=a.getInt(R.styleable.SlidingPanel_speed, 300);

    a.recycle();

    fadeOut=AnimationUtils.loadAnimation(ctxt, R.anim.fade);
}
```

Here, we are loading our fade animation, given a `Context`. This is being put into an `Animation` variable, so we neither know nor care that this particular XML that we are loading defines an `AlphaAnimation` instead of, say, a `RotateAnimation`.

## When It's All Said And Done

Sometimes, you need to take action when an animation completes.

For example, when we close the panel, we want to use a `TranslationAnimation` to slide it down from the open position to closed... then *keep* it closed. With the system used in `SlidingPanel`, keeping the panel closed is a matter of calling `setVisibility()` on the contents with `INVISIBLE`.

However, you cannot do that when the animation begins; otherwise, the panel is gone by the time you try to animate its motion.

Instead, you need to arrange to have it become invisible when the animation ends. To do that, you use an animation listener.

An animation listener is simply an instance of the `AnimationListener` interface, provided to an animation via `setAnimationListener()`. The listener will be invoked when the animation starts, ends, or repeats (the latter courtesy of `CycleInterpolator`, discussed later in this chapter). You can put logic in the `onAnimationEnd()` callback in the listener to take action when the animation finishes.

For example, here is the `AnimationListener` for `SlidingPanel`:

## LEGACY ANIMATIONS

---

```
Animation.AnimationListener collapseListener=new Animation.AnimationListener()  
{  
    public void onAnimationEnd(Animation animation) {  
        setVisibility(View.INVISIBLE);  
    }  
  
    public void onAnimationRepeat(Animation animation) {  
        // not needed  
    }  
  
    public void onAnimationStart(Animation animation) {  
        // not needed  
    }  
};
```

All we do is set our content's visibility to be `INVISIBLE`, thereby closing the panel.

## Loose Fill

You will see attributes, available on `Animation`, named `android:fillEnabled` and `android:fillAfter`. Reading those, you may think that you can dispense with the `AnimationListener` and just use those to arrange to have your widget wind up being “permanently” in the state represented by the end of the animation. All you would have to do is set each of those to true in your animation XML (or the equivalent in Java), and you would be set.

At least for `TranslateAnimation`, you would be mistaken.

It actually will look like it works — the animated widgets will be drawn in their new location. However, if those widgets are clickable, they will not be clicked in their new location, but rather in their old one. This, of course, is not terribly useful.

Hence, even though it is annoying, you will want to use the `AnimationListener` techniques described in this chapter.

## Hit The Accelerator

In addition to the `Animation` classes themselves, Android also provides a set of `Interpolator` classes. These provide instructions for how an animation is supposed to behave during its operating period.

For example, the `AccelerateInterpolator` indicates that, during the duration of an animation, the rate of change of the animation should begin slowly and accelerate

---

## LEGACY ANIMATIONS

---

until the end. When applied to a `TranslateAnimation`, for example, the sliding movement will start out slowly and pick up speed until the movement is complete.

There are several implementations of the `Interpolator` interface besides `AccelerateInterpolator`, including:

1. `AccelerateDecelerateInterpolator`, which starts slowly, picks up speed in the middle, and slows down again at the end
2. `DecelerateInterpolator`, which starts quickly and slows down towards the end
3. `LinearInterpolator`, the default, which indicates the animation should proceed smoothly from start to finish
4. `CycleInterpolator`, which repeats an animation for a number of cycles, following the `AccelerateDecelerateInterpolator` pattern (slow, then fast, then slow)

To apply an interpolator to an animation, simply call `setInterpolator()` on the animation with the `Interpolator` instance, such as the following line from `SlidingPanel`:

```
anim.setInterpolator(new AccelerateInterpolator(1.0f));
```

You can also specify one of the stock interpolators via the `android:interpolator` attribute in your animation XML file.

Android 1.6 added some new interpolators. Notable are `BounceInterpolator` (which gives a bouncing effect as the animation nears the end) and `OvershootInterpolator` (which goes beyond the end of the animation range, then returns to the endpoint).

## Animate. Set. Match.

For the `Animation/SlidingPanelEx` project, though, we want the panel to slide open, but also fade when it slides closed. This implies two animations working at the same time (a fade and a slide). Android supports this via the `AnimationSet` class.

An `AnimationSet` is itself an `Animation` implementation. Following the composite design pattern, it simply cascades the major `Animation` events to each of the animations in the set.

## LEGACY ANIMATIONS

---

To create a set, just create an `AnimationSet` instance, add the animations, and configure the set. For example, here is the logic from the `SlidingPanel` implementation in `Animation/SlidingPanelEx`:

```
public void toggle() {
    TranslateAnimation anim=null;
    AnimationSet set=new AnimationSet(true);

    isOpen=!isOpen;

    if (isOpen) {
        setVisibility(View.VISIBLE);
        anim=new TranslateAnimation(0.0f, 0.0f,
                                   getHeight(),
                                   0.0f);
    }
    else {
        anim=new TranslateAnimation(0.0f, 0.0f, 0.0f,
                                   getHeight());
        anim.setAnimationListener(collapseListener);
        set.addAnimation(fadeOut);
    }

    set.addAnimation(anim);
    set.setDuration(speed);
    set.setInterpolator(new AccelerateInterpolator(1.0f));
    startAnimation(set);
}
```

If the panel is to be opened, we make the contents visible (so we can animate the motion upwards), and create a `TranslateAnimation` for the upward movement. If the panel is to be closed, we create a `TranslateAnimation` for the downward movement, but also add a pre-defined `AlphaAnimation` (`fadeOut`) to an `AnimationSet`. In either case, we add the `TranslateAnimation` to the set, give the set a duration and interpolator, and run the animation.

## Active Animations

Starting with Android 1.5, users could indicate if they wanted to have inter-activity animations: a slide-in/slide-out effect as they switched from activity to activity. However, at that time, they could merely toggle this setting on or off, and applications had no control over these animations whatsoever.

Starting in Android 2.0, though, developers have a bit more control. Specifically:

## LEGACY ANIMATIONS

---

1. Developers can call `overridePendingTransition()` on an Activity, typically after calling `startActivity()` to launch another activity or `finish()` to close up the current activity. The `overridePendingTransition()` indicates an in/out animation pair that should be applied as control passes from this activity to the next one, whether that one is being started (`startActivity()`) or is the one previous on the stack (`finish()`).
2. Developers can start an activity via an Intent containing the `FLAG_ACTIVITY_NO_ANIMATION` flag. As the name suggests, this flag requests that animations on the transitions involving this activity be suppressed.

These are prioritized as follows:

- Any call to `overridePendingTransition()` is always taken into account
- Lacking that, `FLAG_ACTIVITY_NO_ANIMATION` will be taken into account
- In the normal case, where neither of the two are used, whatever the user's preference, via the Settings application, is applied

# Crafting Your Own Views

---

One of the classic forms of code reuse is the GUI widget. Since the advent of Microsoft Windows — and, to some extent, even earlier — developers have been creating their own widgets to extend an existing widget set. These range from 16-bit Windows “custom controls” to 32-bit Windows OCX components to the innumerable widgets available for Java Swing and SWT, and beyond. Android lets you craft your own widgets as well, such as extending an existing widget with a new UI or new behaviors.

This chapter starts with a discussion of the various ways you can go about creating custom View classes. It then moves into an examination of ColorMixer, a [composite widget](#), made up of several other widgets within a layout.

Note that the material in this chapter is focused on creating custom View classes for use within a single Android project. If your goal is to truly create reusable custom widgets, you will also need to learn how to package them so they can be reused — that is covered in a [later chapter](#).

## Prerequisites

Understanding this chapter requires that you have read the core chapters of this book.

## Pick Your Poison

You have five major options for creating a custom View class.

## CRAFTING YOUR OWN VIEWS

---

First, your “custom View class” might really only be custom Drawable resources. Many widgets can adopt a radically different look and feel just with replacement graphics. For example, you might think that these toggle buttons from the Android 2.1 Google Maps application are some fancy custom widget:



*Figure 307: Google Maps navigation toggle buttons*

In reality, those are just radio buttons with replacement images.

Second, your custom View class might be a simple subclass of an existing widget, where you override some behaviors or otherwise inject your own logic. Unfortunately, most of the built-in Android widgets are not really designed for this sort of simple subclassing, so you may be disappointed in how well this particular technique works.

Third, your custom View class might be a composite widget — akin to an activity’s contents, complete with layout and such, but encapsulated in its own class. This allows you to create something more elaborate than you will just by tweaking resources. We will see this later in the chapter with ColorMixer.

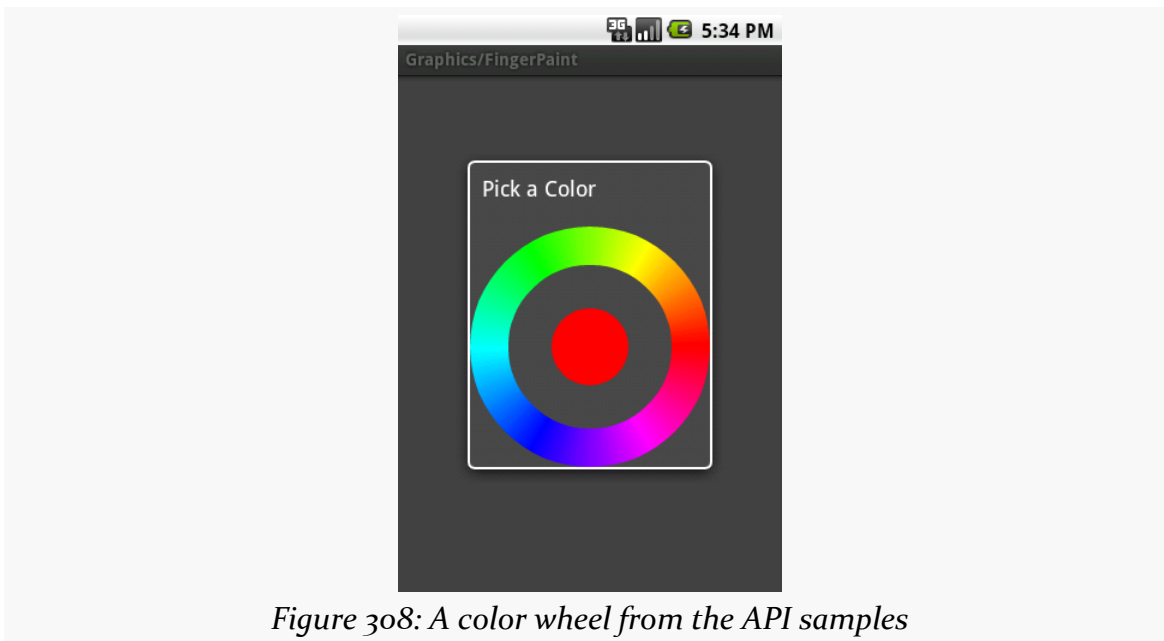
Fourth, you might want to implement your own layout manager, if your GUI rules do not fit well with RelativeLayout, TableLayout, or other built-in containers. For example, you might want to create a layout manager that more closely mirrors the “box model” approach taken by XUL and Flex, or you might want to create one that mirrors Swing’s FlowLayout (laying widgets out horizontally until there is no more room on the current row, then start a new row).

Finally, you might want to do something totally different, where you need to draw the widget yourself. For example, the ColorMixer widget uses SeekBar widgets to control the mix of red, blue, and green. But, you might create a ColorWheel widget that draws a spectrum gradient, detects touch events, and lets the user pick a color that way.

Some of these techniques are fairly simple; others are fairly complex. All share some common traits, such as widget-defined attributes, that we will see throughout the remainder of this chapter.

## Colors, Mixed How You Like Them

The classic way for a user to pick a color in a GUI is to use a color wheel like this one:



*Figure 308: A color wheel from the API samples*

There is even code to make one in the [API samples](#).

However, a color wheel like that is difficult to manipulate on a touch screen, particularly a capacitive touchscreen designed for finger input. Fingers are great for gross touch events and lousy for selecting a particular color pixel.

Another approach is to use a mixer, with sliders to control the red, green, and blue values:



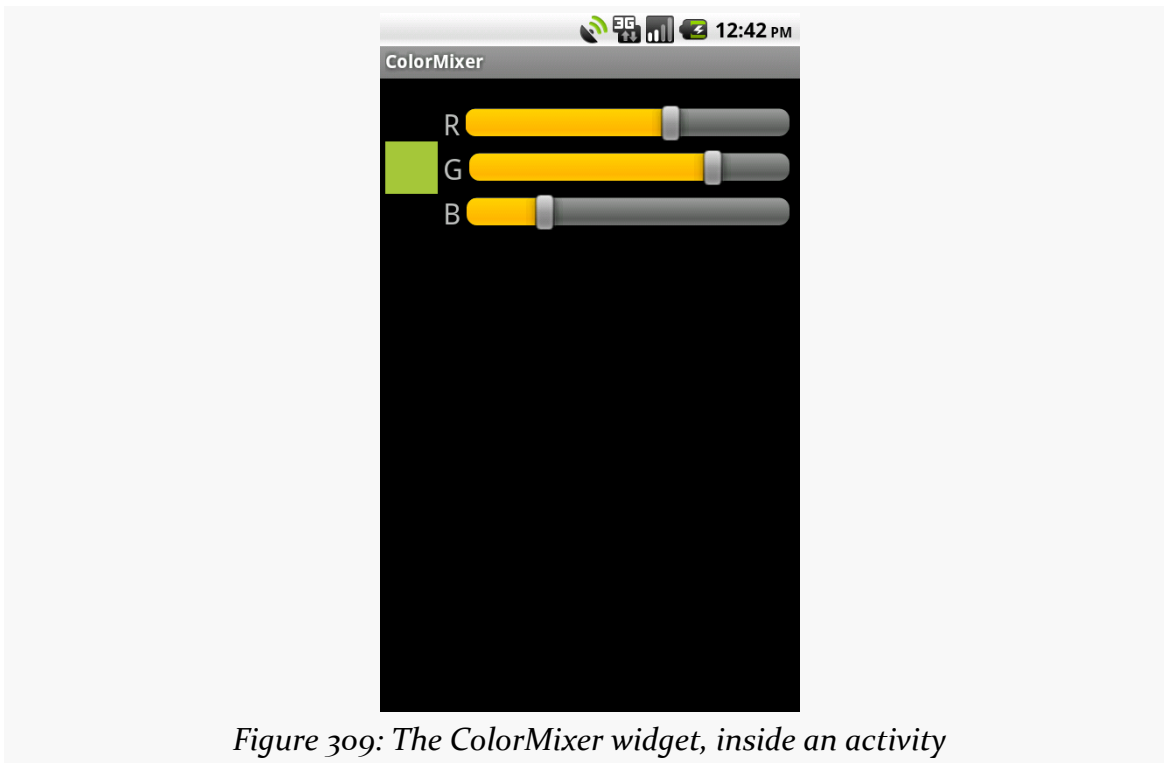


Figure 309: The ColorMixer widget, inside an activity

That is the custom widget you will see in this section, based on the code in the [Views/ColorMixer](#) sample project.

### The Layout

ColorMixer is a composite widget, meaning that its contents are created from other widgets and containers. Hence, we can use a layout file to describe what the widget should look like.

The layout to be used for the widget is not that much: three SeekBar widgets (to control the colors), three TextView widgets (to label the colors), and one plain View (the “swatch” on the left that shows what the currently selected color is). Here is the file, found in `res/layout/mixer.xml` in the Views/ColorMixer project:

```
<?xml version="1.0" encoding="utf-8"?>
<merge xmlns:android="http://schemas.android.com/apk/res/android">
  <View android:id="@+id/swatch"
        android:layout_width="40dip"
        android:layout_height="40dip"
        android:layout_alignParentLeft="true"
        android:layout_centerVertical="true"
        android:layout_marginLeft="4dip"
```

```
/>
<TextView android:id="@+id/redLabel"
  android:layout_width="wrap_content"
  android:layout_height="wrap_content"
  android:layout_alignTop="@id/swatch"
  android:layout_toRightOf="@id/swatch"
  android:layout_marginLeft="4dip"
  android:text="@string/red"
  android:textSize="10pt"
/>
<SeekBar android:id="@+id/red"
  android:layout_width="match_parent"
  android:layout_height="wrap_content"
  android:layout_alignTop="@id/redLabel"
  android:layout_toRightOf="@id/redLabel"
  android:layout_marginLeft="4dip"
  android:layout_marginRight="8dip"
/>
<TextView android:id="@+id/greenLabel"
  android:layout_width="wrap_content"
  android:layout_height="wrap_content"
  android:layout_below="@id/redLabel"
  android:layout_toRightOf="@id/swatch"
  android:layout_marginLeft="4dip"
  android:layout_marginTop="4dip"
  android:text="@string/green"
  android:textSize="10pt"
/>
<SeekBar android:id="@+id/green"
  android:layout_width="match_parent"
  android:layout_height="wrap_content"
  android:layout_alignTop="@id/greenLabel"
  android:layout_toRightOf="@id/greenLabel"
  android:layout_marginLeft="4dip"
  android:layout_marginRight="8dip"
/>
<TextView android:id="@+id/blueLabel"
  android:layout_width="wrap_content"
  android:layout_height="wrap_content"
  android:layout_below="@id/greenLabel"
  android:layout_toRightOf="@id/swatch"
  android:layout_marginLeft="4dip"
  android:layout_marginTop="4dip"
  android:text="@string/blue"
  android:textSize="10pt"
/>
<SeekBar android:id="@+id/blue"
  android:layout_width="match_parent"
  android:layout_height="wrap_content"
  android:layout_alignTop="@id/blueLabel"
  android:layout_toRightOf="@id/blueLabel"
  android:layout_marginLeft="4dip"
  android:layout_marginRight="8dip"
/>
```

```
/>  
</merge>
```

One thing that is a bit interesting about this layout, though, is the root element: `<merge>`. A `<merge>` layout is a bag of widgets that can be poured into some other container. The layout rules on the children of `<merge>` are then used in conjunction with whatever container they are added to. As we will see shortly, `ColorMixer` itself inherits from `RelativeLayout`, and the children of the `<merge>` element will become children of `ColorMixer` in Java. Basically, the `<merge>` element is only there because XML files need a single root — otherwise, the `<merge>` element itself is ignored in the layout.

### The Attributes

Widgets usually have attributes that you can set in the XML file, such as the `android:src` attribute you can specify on an `ImageButton` widget. You can create your own custom attributes that can be used in your custom widget, by creating a `res/values/attrs.xml` file containing `declare-styleable` resources to specify them.

For example, here is the attributes file for `ColorMixer`:

```
<resources>  
  <declare-styleable name="ColorMixer">  
    <attr name="initialColor" format="color" />  
  </declare-styleable>  
</resources>
```

The `declare-styleable` element describes what attributes are available on the widget class specified in the `name` attribute — in our case, `ColorMixer`. Inside `declare-styleable` you can have one or more `attr` elements, each indicating the name of an attribute (e.g., `initialColor`) and what data format the attribute has (e.g., `color`). The data type will help with compile-time validation and in getting any supplied values for this attribute parsed into the appropriate type at runtime.

Here, we indicate there is only one attribute: `initialColor`, which will hold the initial color we want the mixer set to when it first appears.

There are many possible values for the `format` attribute in an `attr` element, including:

1. `boolean`
2. `color`

3. dimension
4. float
5. fraction
6. integer
7. reference (which means a reference to another resource, such as a Drawable)
8. string

You can even support multiple formats for an attribute, by separating the values with a pipe (e.g., `reference|color`).

### The Class

Our `ColorMixer` class, a subclass of `RelativeLayout`, will take those attributes and provide the actual custom widget implementation, for use in activities.

### Constructor Flavors

A `View` has three possible constructors:

1. One takes just a `Context`, which usually will be an `Activity`
2. One takes a `Context` and an `AttributeSet`, the latter of which represents the attributes supplied via layout XML
3. One takes a `Context`, an `AttributeSet`, and the default style to apply to the attributes

If you are expecting to use your custom widget in layout XML files, you will need to implement the second constructor and chain to the superclass. If you want to use styles with your custom widget when declared in layout XML files, you will need to implement the third constructor and chain to the superclass. If you want developers to create instances of your `View` class in Java code directly, you probably should implement the first constructor and, again, chain to the superclass.

In the case of `ColorMixer`, all three constructors are implemented, eventually routing to the three-parameter edition, which initializes our widget. Below, you will see the first two of those constructors, with the third coming up in the next section:

```
public ColorMixer(Context context) {
    this(context, null);
}

public ColorMixer(Context context, AttributeSet attrs) {
```

```
    this(context, attrs, 0);
}
```

### Using the Attributes

The ColorMixer has a starting color — after all, the SeekBar widgets and switch View have to show something. Developers can, if they wish, set that color via a `setColor()` method:

```
public void setColor(int color) {
    red.setProgress(Color.red(color));
    green.setProgress(Color.green(color));
    blue.setProgress(Color.blue(color));
    swatch.setBackgroundColor(color);
}
```

If, however, we want developers to be able to use layout XML, we need to get the value of `initialColor` out of the supplied `AttributeSet`. In `ColorMixer`, this is handled in the three-parameter constructor:

```
public ColorMixer(Context context, AttributeSet attrs, int defStyle) {
    super(context, attrs, defStyle);

    ((Activity)getContext())
        .getLayoutInflater()
        .inflate(R.layout.mixer, this, true);

    swatch=findViewById(R.id.swatch);

    red=(SeekBar)findViewById(R.id.red);
    red.setMax(0xFF);
    red.setOnSeekBarChangeListener(onMix);

    green=(SeekBar)findViewById(R.id.green);
    green.setMax(0xFF);
    green.setOnSeekBarChangeListener(onMix);

    blue=(SeekBar)findViewById(R.id.blue);
    blue.setMax(0xFF);
    blue.setOnSeekBarChangeListener(onMix);

    if (attrs!=null) {
        TypedArray a=getContext()
            .obtainStyledAttributes(attrs,
                R.styleable.ColorMixer,
                0, 0);

        setColor(a.getInt(R.styleable.ColorMixer_initialColor,
            0xFFA4C639));
        a.recycle();
    }
}
```

```
}  
}
```

There are three steps for getting attribute values:

- Get a `TypedArray` conversion of the `AttributeSet` by calling `obtainStyledAttributes()` on our `Context`, supplying it the `AttributeSet` and the ID of our styleable resource (in this case, `R.styleable.ColorMixer`, since we set the name of the declare-styleable element to be `ColorMixer`)
- Use the `TypedArray` to access specific attributes of interest, by calling an appropriate getter (e.g., `getInt()`) with the ID of the specific attribute to fetch (`R.styleable.ColorMixer_initialColor`)
- Recycle the `TypedArray` when done, via a call to `recycle()`, to make the object available to Android for use with other widgets via an object pool (versus creating new instances every time)

Note that the name of any given attribute, from the standpoint of `TypedArray`, is the name of the styleable resource (`R.styleable.ColorMixer`) concatenated with an underscore and the name of the attribute itself (`_initialColor`).

In `ColorMixer`, we get the attribute and pass it to `setColor()`. Since `getColor()` on `AttributeSet` takes a default value, we supply some stock color that will be used if the developer declined to supply an `initialColor` attribute.

Also note that our `ColorMixer` constructor inflates the widget's layout. In particular, it supplies `true` as the third parameter to `inflate()`, meaning that the contents of the layout should be added as children to the `ColorMixer` itself. When the layout is inflated, the `<merge>` element is ignored, and the `<merge>` element's children are added as children to the `ColorMixer`.

### Saving the State

Similar to activities, a custom `View` overrides `onSaveInstanceState()` and `onRestoreInstanceState()` to persist data as needed, such as to handle a screen orientation change. The biggest difference is that rather than receive a `Bundle` as a parameter, `onSaveInstanceState()` must return a `Parcelable` with its state... including whatever state comes from the parent `View`.

The simplest way to do that is to return a `Bundle`, in which we have filled in our state (the chosen color) and the parent class' state (whatever that may be).

## CRAFTING YOUR OWN VIEWS

---

So, for example, here are implementations of `onSaveInstanceState()` and `onRestoreInstanceState()` from `ColorMixer`:

```
@Override
public Parcelable onSaveInstanceState() {
    Bundle state=new Bundle();

    state.putParcelable(SUPERSTATE, super.onSaveInstanceState());
    state.putInt(COLOR, getColor());

    return(state);
}

@Override
public void onRestoreInstanceState(Parcelable ss) {
    Bundle state=(Bundle)ss;

    super.onRestoreInstanceState(state.getParcelable(SUPERSTATE));

    setColor(state.getInt(COLOR));
}
```

### The Rest of the Functionality

`ColorMixer` defines a callback interface, named `OnColorChangeListener`:

```
public interface OnColorChangeListener {
    public void onColorChange(int argb);
}
```

`ColorMixer` also provides getters and setters for an `OnColorChangeListener` object:

```
public OnColorChangeListener getOnColorChangeListener() {
    return(listener);
}

public void setOnColorChangeListener(OnColorChangeListener listener) {
    this.listener=listener;
}
```

The rest of the logic is mostly tied up in the `SeekBar` handler, which will adjust the swatch based on the new color and invoke the `OnColorChangeListener` object, if there is one:

```
private SeekBar.OnSeekBarChangeListener onMix=new
SeekBar.OnSeekBarChangeListener() {
    public void onProgressChanged(SeekBar seekBar, int progress,
        boolean fromUser) {
        int color=getColor();
```

```
swatch.setBackgroundColor(color);

if (listener!=null) {
    listener.onColorChange(color);
}
}

public void onStartTrackingTouch(SeekBar seekBar) {
    // unused
}

public void onStopTrackingTouch(SeekBar seekBar) {
    // unused
}
};
```

### Seeing It In Use

The project contains a sample activity, ColorMixerDemo, that shows the use of the ColorMixer widget.

The layout for that activity, shown below, can be found in `res/layout/main.xml` of the Views/ColorMixer project:

```
<?xml version="1.0" encoding="utf-8"?>
<LinearLayout xmlns:android="http://schemas.android.com/apk/res/android"
    xmlns:mixer="http://schemas.android.com/apk/res-auto"
    android:layout_width="match_parent"
    android:layout_height="wrap_content"
    android:orientation="vertical"
    >
    <TextView android:id="@+id/color"
        android:layout_width="wrap_content"
        android:layout_height="wrap_content"
        />
    <com.commonware.android.colormixer.ColorMixer
        android:id="@+id/mixer"
        android:layout_width="wrap_content"
        android:layout_height="wrap_content"
        mixer:initialColor="#FFA4C639"
        />
</LinearLayout>
```

Notice that the root `LinearLayout` element defines two namespaces, the standard `android` namespace, and a separate one named `mixer`. The `mixer` namespace is given a URL of `http://schemas.android.com/apk/res-auto`, which indicates to the Android build system to match up `mixer` attributes with their respective widgets that are supplied via Android library projects.



---

## CRAFTING YOUR OWN VIEWS

---

Our ColorMixer widget is in the layout, with a fully-qualified class name (`com.commonsware.android.colormixer.ColorMixer`), since ColorMixer is not in the `android.widget` package. Notice that we can treat our custom widget like any other, giving it a width and height and so on.

The one attribute of our ColorMixer widget that is unusual is `mixer:initialColor`. `initialColor`, you may recall, was the name of the attribute we declared in `res/values/attrs.xml` and retrieve in Java code, to represent the color to start with. The `mixer` namespace is needed to identify where Android should be pulling the rules for what sort of values an `initialColor` attribute can hold. Since our `<attr>` element indicated that the format of `initialColor` was `color`, Android will expect to see a color value here, rather than a string or dimension.

The ColorMixerDemo activity is not very elaborate:

```
package com.commonsware.android.colormixer;

import android.app.Activity;
import android.os.Bundle;
import android.widget.TextView;

public class ColorMixerDemo extends Activity {
    private TextView color=null;

    @Override
    public void onCreate(Bundle icle) {
        super.onCreate(icle);
        setContentView(R.layout.main);

        color=(TextView)findViewById(R.id.color);

        ColorMixer mixer=(ColorMixer)findViewById(R.id.mixer);

        mixer.setOnColorChangeListener(onColorChange);
    }

    private ColorMixer.OnColorChangeListener onColorChange=
        new ColorMixer.OnColorChangeListener() {
            public void onColorChange(int argb) {
                color.setText(Integer.toHexString(argb));
            }
        };
}
```

It gets access to both the ColorMixer and the TextView in the main layout, then registers an `OnColorChangeListener` with the ColorMixer. That listener, in turn, puts the value of the color in the TextView, so the user can see the hex value of the color along with the shade itself in the swatch.

# Custom Dialogs and Preferences

---

Android ships with a number of dialog classes for specific circumstances, like `DatePickerDialog` and `ProgressDialog`. Similarly, Android comes with a smattering of Preference classes for your `PreferenceActivity`, to accept text or selections from lists and so on.

However, there is plenty of room for improvement in both areas. As such, you may find the need to create your own custom dialog or preference class. This chapter will show you how that is done.

We start off by looking at creating a [custom `AlertDialog`](#), not by using `AlertDialog.Builder`, but via a custom subclass. Then, we show how to create your [own dialog-style Preference](#), where tapping on the preference pops up a dialog to allow the user to customize the preference value.

## Prerequisites

Understanding this chapter requires that you have read [the chapter on dialogs](#), along with [the chapter on the preference system](#). Also, the samples here use the custom `ColorMixer` View described [in another chapter](#).

## Your Dialog, Chocolate-Covered

For your own application, the simplest way to create a custom `AlertDialog` is to use `AlertDialog.Builder`, as described [in a previous chapter](#). You do not need to create any special subclass — just call methods on the `Builder`, then `show()` the resulting dialog.

## CUSTOM DIALOGS AND PREFERENCES

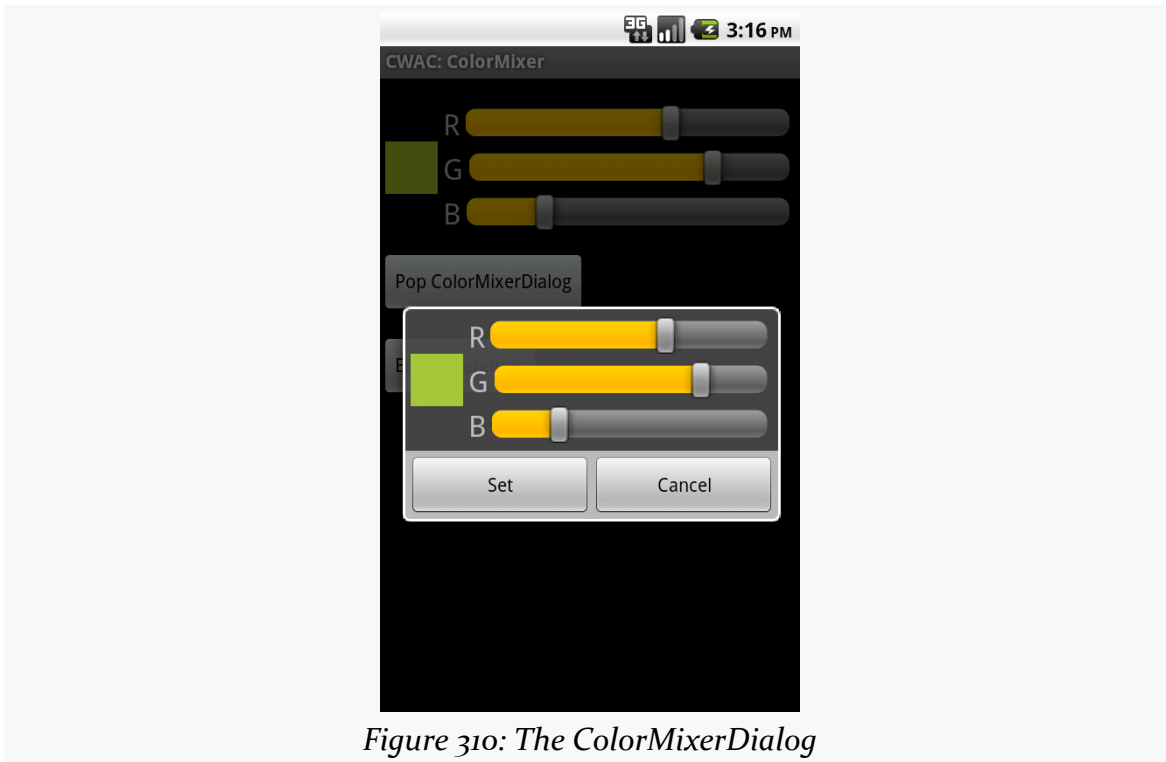
---

However, if you want to create a reusable `AlertDialog`, this may become problematic. For example, where would this code to create the custom `AlertDialog` reside?

So, in some cases, you may wish to extend `AlertDialog` and supply the dialog's contents that way, which is how `TimePickerDialog` and others are implemented. Unfortunately, this technique is not well documented. This section will illustrate how to create such an `AlertDialog` subclass, as determined by looking at how the core Android team did it for their own dialogs.

The sample code is `ColorMixerDialog`, a dialog wrapping around the `ColorMixer` widget shown in a previous chapter. The implementation of `ColorMixerDialog` can be found in the [CWAC-ColorMixer](#) GitHub repository, as it is part of the CommonsWare Android Components.

Using this dialog works much like using `DatePickerDialog` or `TimePickerDialog`. You create an instance of `ColorMixerDialog`, supplying the initial color to show and a listener object to be notified of color changes. Then, call `show()` on the dialog. If the user makes a change and accepts the dialog, your listener will be informed.



*Figure 310: The ColorMixerDialog*

## Basic AlertDialog Setup

The `ColorMixerDialog` class is not especially long, since all of the actual color mixing is handled by the `ColorMixer` widget:

```
public ColorMixerDialog(Context ctxt,
                        int initialColor,
                        ColorMixer.OnColorChangeListener onSet) {
    super(ctxt);

    this.initialColor=initialColor;
    this.onSet=onSet;

    ParcelHelper parcel=new ParcelHelper("cwav-colormixer", ctxt);

    mixer=new ColorMixer(ctxt);
    mixer.setColor(initialColor);

    setView(mixer);
    setButton(ctxt.getText(parcel.getIdentifier("set", "string")),
              this);
    setButton2(ctxt.getText(parcel.getIdentifier("cancel", "string")),
               (DialogInterface.OnClickListener)null);
}
```

We extend the `AlertDialog` class and implement a constructor of our own design. In this case, we take in three parameters:

1. A `Context` (typically an `Activity`), needed for the superclass
2. The initial color to use for the dialog, such as if the user is editing a color they chose before
3. A `ColorMixer.OnColorChangeListener` object, just like `ColorMixer` uses, to notify the dialog creator when the color is changed

We then create a `ColorMixer` and call `setView()` to make that be the main content of the dialog. We also call `setButton()` and `setButton2()` to specify a “Set” and “Cancel” button for the dialog. The latter just dismisses the dialog, so we need no event handler. The former we route back to the `ColorMixerDialog` itself, which implements the `DialogInterface.OnClickListener` interface.

This class is part of a parcel, designed to be reused by many projects. Hence, we cannot simply reference standard resources via the `R.` syntax — rather, we use a `ParcelHelper` to find out the right resource IDs on the fly at runtime. More information on why this is needed can be found in the [chapter on reusable components](#).

## Handling Color Changes

When the user clicks the “Set” button, we want to notify the application about the color change...if the color actually changed. This is akin to `DatePickerDialog` and `TimePickerDialog` only notifying you of date or times if the user clicks Set and actually changed the values.

The `ColorMixerDialog` tracks the initial color via the `initialColor` data member. In the `onClick()` method — required by `DialogInterface.OnClickListener` — we see if the mixer has a different color than the `initialColor`, and if so, we call the supplied `ColorMixer.OnColorChangeListener` callback object:

```
@Override
public void onClick(DialogInterface dialog, int which) {
    if (initialColor!=mixer.getColor()) {
        onSet.onColorChange(mixer.getColor());
    }
}
```

## State Management

Dialogs use `onSaveInstanceState()` and `onRestoreInstanceState()`, just like activities do. That way, if the screen is rotated, or if the hosting activity is being evicted from RAM when it is not in the foreground, the dialog can save its state, then get it back later as needed.

The biggest difference with `onSaveInstanceState()` for a dialog is that the `Bundle` of state data is not passed into the method. Rather, you get the `Bundle` by chaining to the superclass, then adding your data to the `Bundle` it returned, before returning it yourself:

```
@Override
public Bundle onSaveInstanceState() {
    Bundle state=super.onSaveInstanceState();

    state.putInt(COLOR, mixer.getColor());

    return(state);
}
```

The `onRestoreInstanceState()` pattern is much closer to the implementation you would find in an `Activity`, where the `Bundle` with the state data to restore is passed in as a parameter:

```
@Override
public void onRestoreInstanceState(Bundle state) {
    super.onRestoreInstanceState(state);

    mixer.setColor(state.getInt(COLOR));
}
```

## Preferring Your Own Preferences, Preferably

The Android Settings application, built using the Preference system, has lots of custom Preference classes. You too can create your own Preference classes, to collect things like dates, numbers, or colors. Once again, though, the process of creating such classes is not well documented. This section reviews one recipe for making a Preference — specifically, a subclass of `DialogPreference` — based on the implementation of other Preference classes in Android.

The result is `ColorPreference`, a Preference that uses the `ColorMixer` widget. As with the `ColorMixerDialog` from the previous section, the `ColorPreference` is from the CommonsWare Android Components, and its source code can be found in the [CWAC-ColorMixer](#) GitHub repository.

One might think that `ColorPreference`, as a subclass of `DialogPreference`, might use `ColorMixerDialog`. However, that is not the way it works, as you will see.

### The Constructor

A Preference is much like a [custom View](#), in that there are a variety of constructors, some taking an `AttributeSet` (for the preference properties), and some taking a default style. In the case of `ColorPreference`, we need to get the string resources to use for the names of the buttons in the dialog box, providing them to `DialogPreference` via `setPositiveButtonText()` and `setNegativeButtonText()`. Since `ColorPreference` is part of a parcel, it uses the parcel system to look up the string resource — a custom Preference that would be just part of a project could just use `getString()` directly.

Here, we just implement the standard two-parameter constructor, since that is the one that is used when this preference is inflated from a preference XML file:

```
public ColorPreference(Context ctxt, AttributeSet attrs) {
    super(ctxt, attrs);

    ParcelHelper parcel=new ParcelHelper("cwac-colormixer", ctxt);
```

```
        setPositiveButtonText(ctxt.getText(parcel.getIdentifier("set", "string")));
        setNegativeButtonText(ctxt.getText(parcel.getIdentifier("cancel",
"string")));
    }
```

### Creating the View

The `DialogPreference` class handles the pop-up dialog that appears when the preference is clicked upon by the user. Subclasses get to provide the `View` that goes inside the dialog. This is handled a bit reminiscent of a `CursorAdapter`, in that there are two separate methods to be overridden:

- `onCreateDialogView()` works like `newView()` of `CursorAdapter`, returning a `View` that should go in the dialog
- `onBindDialogView()` works like `bindView()` of `CursorAdapter`, where the custom `Preference` is supposed to configure the `View` for the current preference value

In the case of `ColorPreference`, we use a `ColorMixer` for the `View`:

```
@Override
protected View onCreateDialogView() {
    mixer=new ColorMixer(getContext());

    return(mixer);
}
```

Then, in `onBindDialogView()`, we set the mixer's color to be `lastColor`, a private data member:

```
@Override
protected void onBindDialogView(View v) {
    super.onBindDialogView(v);

    mixer.setColor(lastColor);
}
```

We will see later in this section where `lastColor` comes from – for the moment, take it on faith that it holds the user's chosen color, or a default value.

### Dealing with Preference Values

Of course, the whole point behind a `Preference` is to allow the user to set some value that the application will then use later on. Dealing with values is a bit tricky with `DialogPreference`, but not too bad.

### Getting the Default Value

The preference XML format has an `android:defaultValue` attribute, which holds the default value to be used by the preference. Of course, the actual data type of the value will differ widely — an `EditTextPreference` might expect a `String`, while `ColorPreference` needs a color value.

Hence, you need to implement `onGetDefaultValue()`. This is passed a `TypedArray` — similar to how a custom `View` uses a `TypedArray` for getting at its custom attributes in an XML layout file. It is also passed an index number into the array representing `android:defaultValue`. The custom `Preference` needs to return an `Object` representing its interpretation of the default value.

In the case of `ColorPreference`, we simply get an integer out of the `TypedArray`, representing the color value, with an overall default value of `0xFFA4C639` (a.k.a., Android green):

```
@Override
protected Object onGetDefaultValue(TypedArray a, int index) {
    return(a.getInt(index, 0xFFA4C639));
}
```

### Setting the Initial Value

When the user clicks on the preference, the `DialogPreference` supplies the last-known preference value to its subclass, or the default value if this preference has not been set by the user to date.

The way this works is that the custom `Preference` needs to override `onSetInitialValue()`. This is passed in a boolean flag (`restoreValue`) indicating whether or not the user set the value of the preference before. It is also passed the `Object` returned by `onGetDefaultValue()`. Typically, a custom `Preference` will look at the flag and choose to either use the default value or load the already-set preference value.

To get the existing value, `Preference` defines a set of type-specific getter methods — `getPersistedInt()`, `getPersistedString()`, etc. So, `ColorPreference` uses `getPersistedInt()` to get the saved color value:

```
@Override
protected void onSetInitialValue(boolean restoreValue, Object defaultValue) {
    lastColor=(restoreValue ? getPersistedInt(lastColor) :
```



```
(Integer)defaultValue);  
}
```

Here, `onSetInitialValue()` stores that value in `lastColor` — which then winds up being used by `onBindDialogView()` to tell the `ColorMixer` what color to show.

### Closing the Dialog

When the user closes the dialog, it is time to persist the chosen color from the `ColorMixer`. This is handled by the `onDialogClosed()` callback method on your custom Preference:

```
@Override  
protected void onDialogClosed(boolean positiveResult) {  
    super.onDialogClosed(positiveResult);  
  
    if (positiveResult) {  
        if (callChangeListener(mixer.getColor())) {  
            lastColor=mixer.getColor();  
            persistInt(lastColor);  
        }  
    }  
}
```

The passed-in boolean indicates if the user accepted or dismissed the dialog, so you can elect to skip saving anything if the user dismissed the dialog. The other `DialogPreference` implementations also call `callChangeListener()`, which is somewhat ill-documented. Assuming both the flag and `callChangeListener()` are true, the Preference should save its value to the persistent store via `persistInt()`, `persistString()`, or `kin`.

### Using the Preference

Given all of that, using the custom Preference class in an application is almost anticlimactic. You simply add it to your preference XML, with a fully-qualified class name:

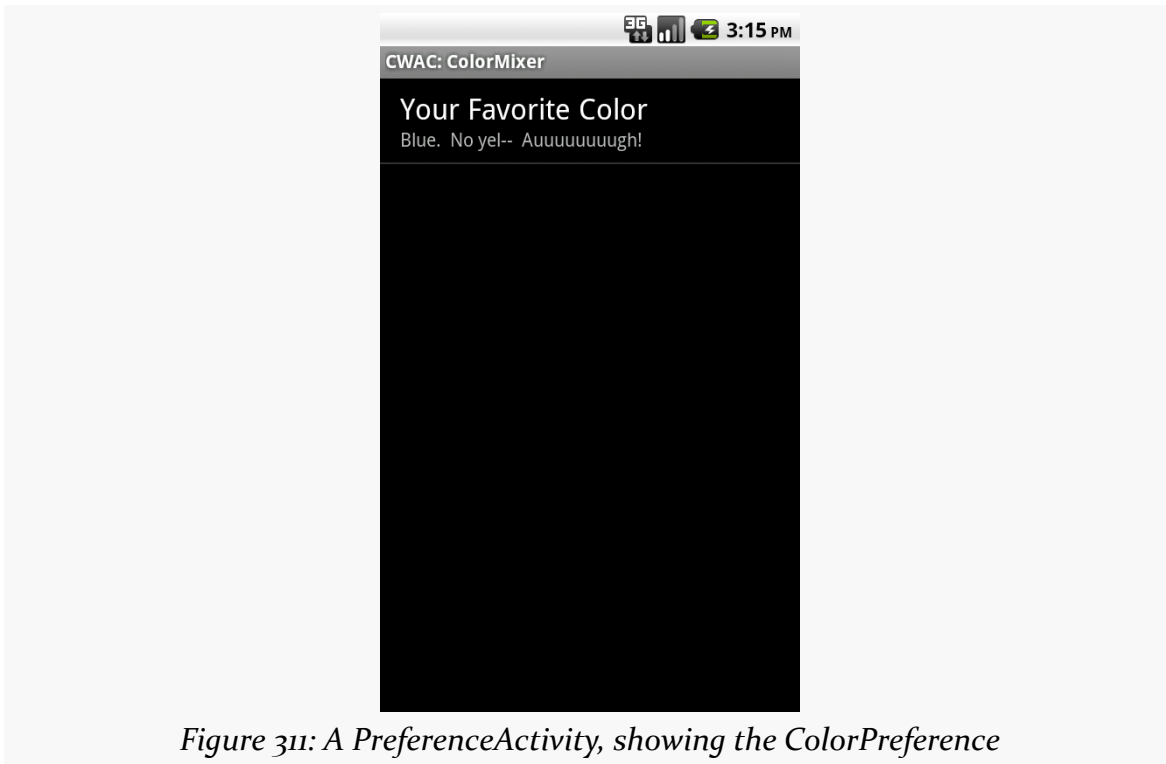
```
<PreferenceScreen  
    xmlns:android="http://schemas.android.com/apk/res/android">  
    <com.commonware.cwac.colormixer.ColorPreference  
        android:key="favoriteColor"  
        android:defaultValue="0xFFA4C639"  
        android:title="Your Favorite Color"  
        android:summary="Blue. No yel-- Auuuuuuuugh!" />  
</PreferenceScreen>
```

## CUSTOM DIALOGS AND PREFERENCES

---

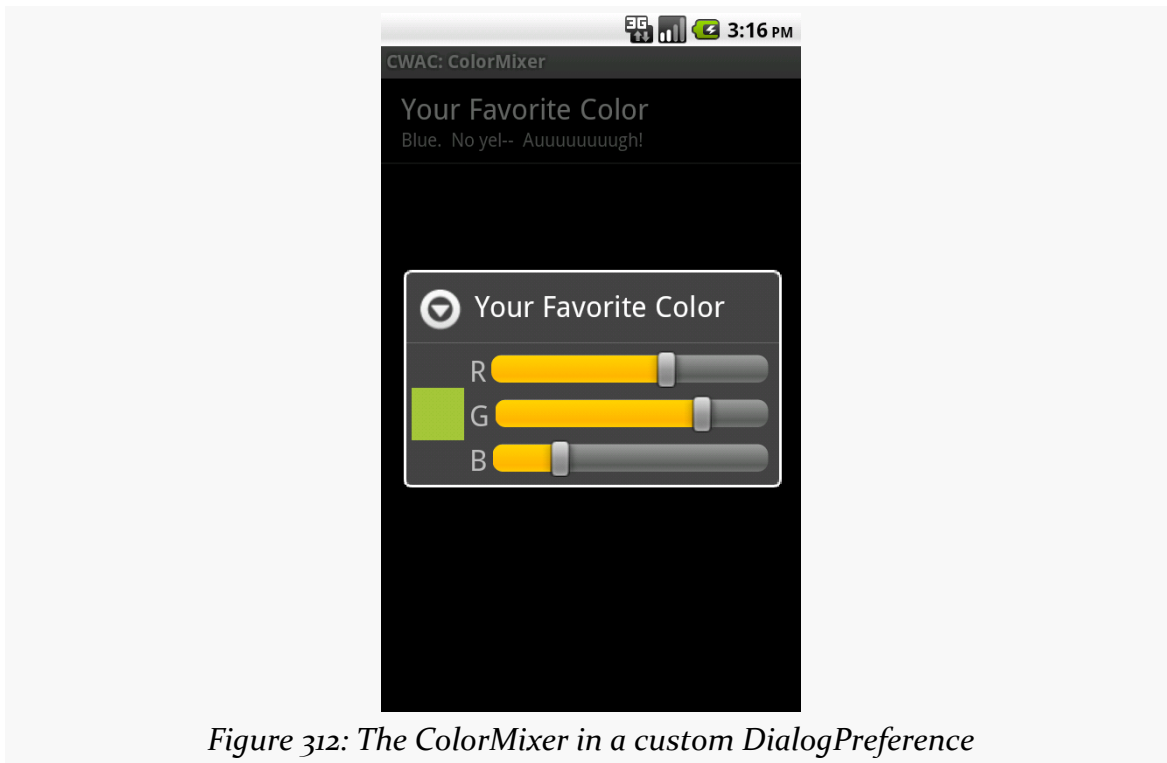
At this point, it behaves no differently than does any other Preference type. Since ColorPreference stores the value as an integer, your code would use `getInt()` on the `SharedPreferences` to retrieve the value when needed.

The user sees an ordinary preference entry in the `PreferenceActivity`:



*Figure 311: A PreferenceActivity, showing the ColorPreference*

When tapped, it brings up the mixer:



*Figure 312: The ColorMixer in a custom DialogPreference*

Choosing a color and pressing the BACK button persists the color value as a preference.

# Progress Indicators

---

Sometimes, we make the user wait. And wait. And wait some more.

Often, in these cases, it is useful to let the user know that something they requested is something that we are diligently working on. To do this, we can use some form of progress indicator. We saw basic use of a `ProgressBar` in the tutorials earlier in this book — now is the time to take a much closer look at `ProgressBar` and other means of displaying progress.

## Prerequisites

Understanding this chapter requires that you have read the core chapters of this book. Having read the chapters on [dialogs](#), [custom drawables](#), and [animators](#) is also a good idea.

## Progress Bars

The classic way to tell the user that we are doing something for them is to use a `ProgressBar` widget, much as we briefly displayed one in the `EmPubLite` sample app in the tutorials.

However, a `ProgressBar` is much more than a simple spinning image. We can use it to display either indeterminate progress (“we will be done... sometime”) or specific progress (“we are 34% complete”). We can use it either as a circle or as a classic horizontal bar, the latter typically used for specific progress. And, for specific progress, we can actually show two tiers of progress, known as “primary” and “secondary” (e.g., primary for the progress in copying a directory’s worth of files, secondary for the progress on a specific file).

In this section, we will take a look at these different ways of using ProgressBar.

### Circular vs. Horizontal

As the name suggests, a ProgressBar denotes progress. As the name does not suggest, a ProgressBar is not a bar, by default — it is a circle. Hence, the following element from an XML layout resource:

```
<ProgressBar
  android:id="@+id/progressCI"
  android:layout_width="wrap_content"
  android:layout_height="wrap_content"
  android:layout_gravity="center_horizontal"
  android:layout_marginBottom="20dp"
  android:layout_marginTop="20dp"/>
```

gives us:



*Figure 313: Android 4.0 ProgressBar, Default Style*

However, referencing `style="?android:attr/progressBarStyleHorizontal"` in the element:

```
<ProgressBar
  android:id="@+id/progressHI"
  style="?android:attr/progressBarStyleHorizontal"
  android:layout_width="match_parent"
  android:layout_height="wrap_content"
  android:layout_marginBottom="20dp"
  android:indeterminate="true"/>
```

gives us a horizontal bar:



*Figure 314: Android 4.0 ProgressBar, Horizontal Style*

Note that the look-and-feel of these widgets have changed over the years. On Android 1.x and 2.x, they will look like this:



*Figure 315: Android 2.3.3 ProgressBar, Both Styles*

### Specific vs. Indeterminate

Typically, you use the circular `ProgressBar` style for indeterminate progress, where the circle simply spins in place to let the user know that work is proceeding and the device (or activity) has not frozen. The horizontal `ProgressBar` style is used to illustrate specific amounts of progress, from 0 to a value you choose.

However, while those patterns are typical, the choice of whether to use indeterminate or some specific amount of progress is independent of the style of the widget.

The `android:indeterminate` attribute controls whether the `ProgressBar` will render an indeterminate look or a specific look. For the latter, calls to `setMax()` (or the `android:max` attribute) will set the upper end of the progress range (the default is 100), and `setProgress()` or `incrementProgressBy()` will set how much progress along that range is illustrated.



*Figure 316: Android 4.0 ProgressBar, Horizontal Style, Indeterminate and Specific*



*Figure 317: Android 2.3.3 ProgressBar, Horizontal Style, Indeterminate and Specific*

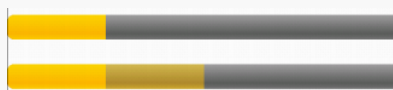
### Primary vs. Secondary

For specific progress, you actually have two independent amounts of progress. `setProgress()`, `incrementProgressBy()`, and `android:progress` control the primary progress, while `setSecondaryProgress()`, `incrementSecondaryProgressBy()`, and `android:secondaryProgress` control the secondary progress. Here, “primary progress” refers to the progress along an entire piece of work (e.g., copying a folder’s worth of files), while “secondary progress” refers the progress along a discrete chunk of the overall work (e.g., copying an individual file).

A `ProgressBar` will render these with different colors, though primary trumps secondary, and so the secondary progress will only be visible when its value exceeds that of the primary progress:



*Figure 318: Android 4.0 ProgressBar, Horizontal Style, Primary-Only and Primary-Plus-Secondary*



*Figure 319: Android 2.3.3 ProgressBar, Horizontal Style, Primary-Only and Primary-Plus-Secondary*

### ProgressBar and Threads

Normally, you cannot update the UI of a widget from a background thread.

`ProgressBar` is an exception. You *can* safely call `setProgress()` and `incrementProgressBy()` from a background thread to update the primary progress, and you can safely call `setSecondaryProgress()` and `incrementSecondaryProgressBy()` from a background thread to update the secondary progress.

To see this in action, take a look at the [Progress/BarSampler](#) sample project.

This project has a single activity (`MainActivity`), whose layout (`activity_main.xml`) contains four `ProgressBar` widgets, two indeterminate and two for specific progress:

## PROGRESS INDICATORS

---

```
<LinearLayout xmlns:android="http://schemas.android.com/apk/res/android"
    xmlns:tools="http://schemas.android.com/tools"
    android:layout_width="match_parent"
    android:layout_height="match_parent"
    android:orientation="vertical">

    <ProgressBar
        android:id="@+id/progressCI"
        android:layout_width="wrap_content"
        android:layout_height="wrap_content"
        android:layout_gravity="center_horizontal"
        android:layout_marginBottom="20dp"
        android:layout_marginTop="20dp"/>

    <ProgressBar
        android:id="@+id/progressHI"
        style="?android:attr/progressBarStyleHorizontal"
        android:layout_width="match_parent"
        android:layout_height="wrap_content"
        android:layout_marginBottom="20dp"
        android:indeterminate="true"/>

    <ProgressBar
        android:id="@+id/progressHS"
        style="?android:attr/progressBarStyleHorizontal"
        android:layout_width="fill_parent"
        android:layout_height="wrap_content"
        android:layout_marginBottom="20dp"
        android:indeterminate="false"
        android:max="100"/>

    <ProgressBar
        android:id="@+id/progressHS2"
        style="?android:attr/progressBarStyleHorizontal"
        android:layout_width="match_parent"
        android:layout_height="wrap_content"
        android:max="100"/>

</LinearLayout>
```

The activity gets access to the latter two `ProgressBar` widgets and sets up a `ScheduledThreadPoolExecutor` to get control every second in a background thread, which calls our `run()` method. The `run()` method will increment both `ProgressBar` widgets primary progress by 2 each time, and the secondary progress by 10 (dropping back to the starting point when the secondary progress reaches the maximum of 100). When the primary progress gets to 100, we cancel our scheduled work in the `ScheduledThreadPoolExecutor`:

```
package com.commonsware.android.progress;

import android.app.Activity;
```



## PROGRESS INDICATORS

---

```
import android.os.Bundle;
import android.widget.ProgressBar;
import java.util.concurrent.ScheduledThreadPoolExecutor;
import java.util.concurrent.TimeUnit;

public class MainActivity extends Activity implements Runnable {
    private static final int PERIOD_SECONDS=1;
    private ScheduledThreadPoolExecutor executor=
        new ScheduledThreadPoolExecutor(1);
    private ProgressBar primary=null;
    private ProgressBar secondary=null;

    @Override
    public void onCreate(Bundle savedInstanceState) {
        super.onCreate(savedInstanceState);
        setContentView(R.layout.activity_main);

        primary=(ProgressBar)findViewById(R.id.progressHS);
        secondary=(ProgressBar)findViewById(R.id.progressHS2);

        executor.setExecuteExistingDelayedTasksAfterShutdownPolicy(false);
        executor.scheduleAtFixedRate(this, 0, PERIOD_SECONDS,
            TimeUnit.SECONDS);
    }

    @Override
    public void onDestroy() {
        executor.shutdown();

        super.onDestroy();
    }

    @Override
    public void run() {
        if (primary.getProgress() < 100) {
            primary.incrementProgressBy(2);
            secondary.incrementProgressBy(2);

            if (secondary.getSecondaryProgress() == 100) {
                secondary.setSecondaryProgress(10);
            }
            else {
                secondary.incrementSecondaryProgressBy(10);
            }
        }
        else {
            executor.remove(this);
        }
    }
}
```

The net effect is that you see the progress march across the screen, with the secondary progress going through five passes for the primary progress' single pass through the 0–100 range.

## Tailoring Progress Bars

The stock `ProgressBar` look and feel is decent, if perhaps not spectacular. Often times, the stock look is sufficient for your needs. If you wish to have greater control over the look of your `ProgressBar`, the following sections will demonstrate some possibilities.

### Changing the Progress Colors

The `ProgressBar` uses different colors for primary and secondary specific progress. By default, those colors are defined by the theme you are using, and the stock themes have firmware-defined colors (e.g., yellows for Android 1.x and 2.x, blues for Android 3.x and higher).

However, you can change the colors by using a [LayerListDrawable](#) and associating it with a `ProgressBar` by means of the `android:progressDrawable` attribute.

The `ProgressBar` background image needs to be a `LayerListDrawable` with three specific layers:

- `android:id="@android:id/background"` for the background color of the bar
- `android:id="@android:id/progress"` for the primary progress
- `android:id="@android:id/secondaryProgress"` for the secondary progress

Whether those layers are defined as [ShapeDrawable structures](#), or as [nine-patch PNG files](#) is up to you, but they will need the ability to stretch to fit however big your bar winds up being.

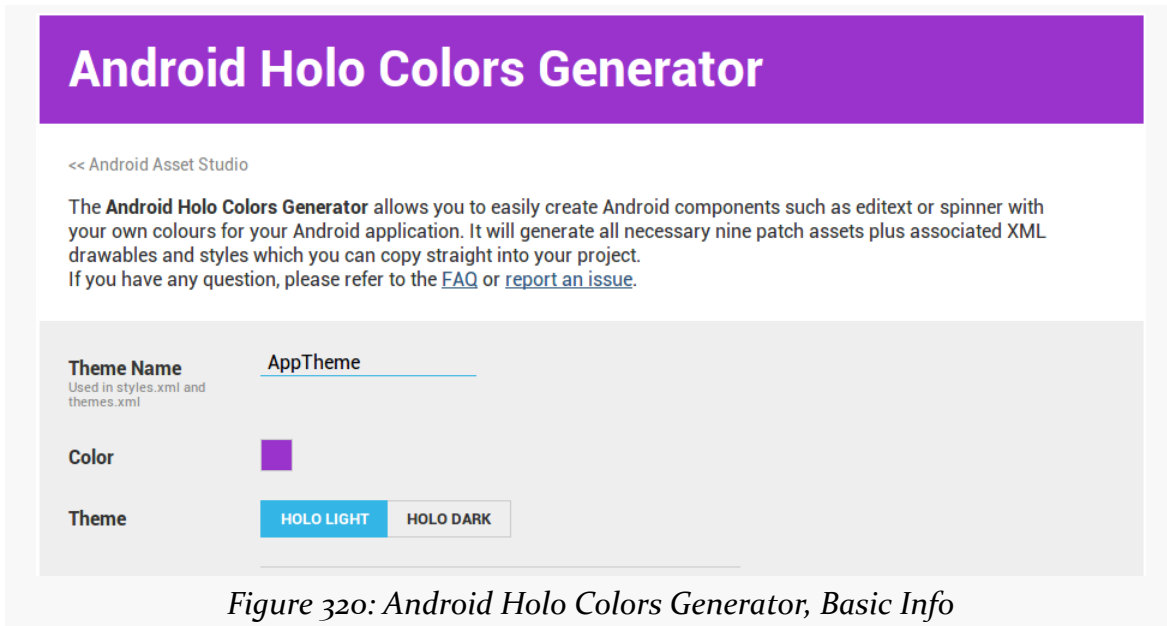
To see what this means, let's take a look at the [Progress/Styled](#) sample project. This is a near-clone of the `Progress/BarSampler` project from earlier, using custom backgrounds for the bars. Here, we will look at the horizontal `ProgressBar` widgets — in [the next section](#), we will look at how to change the background of a circular indefinite `ProgressBar`.

## PROGRESS INDICATORS

---

For the first horizontal ProgressBar (progressHS), we will use a custom style created by Jérôme Van Der Linden's [Android Holo Colors Generator](#), a Web site set up to help us create custom versions of the holographic widget theme.

When you visit this site in Google Chrome (note: other browsers are not supported at this time), you can fill in a name for your theme (e.g., "AppTheme"), the color scheme to use for the theme, and the foundation theme to use (light or dark):



*Figure 320: Android Holo Colors Generator, Basic Info*

You can then toggle on and off which widgets you intend to use, so the generator will create custom styles for them:

## PROGRESS INDICATORS

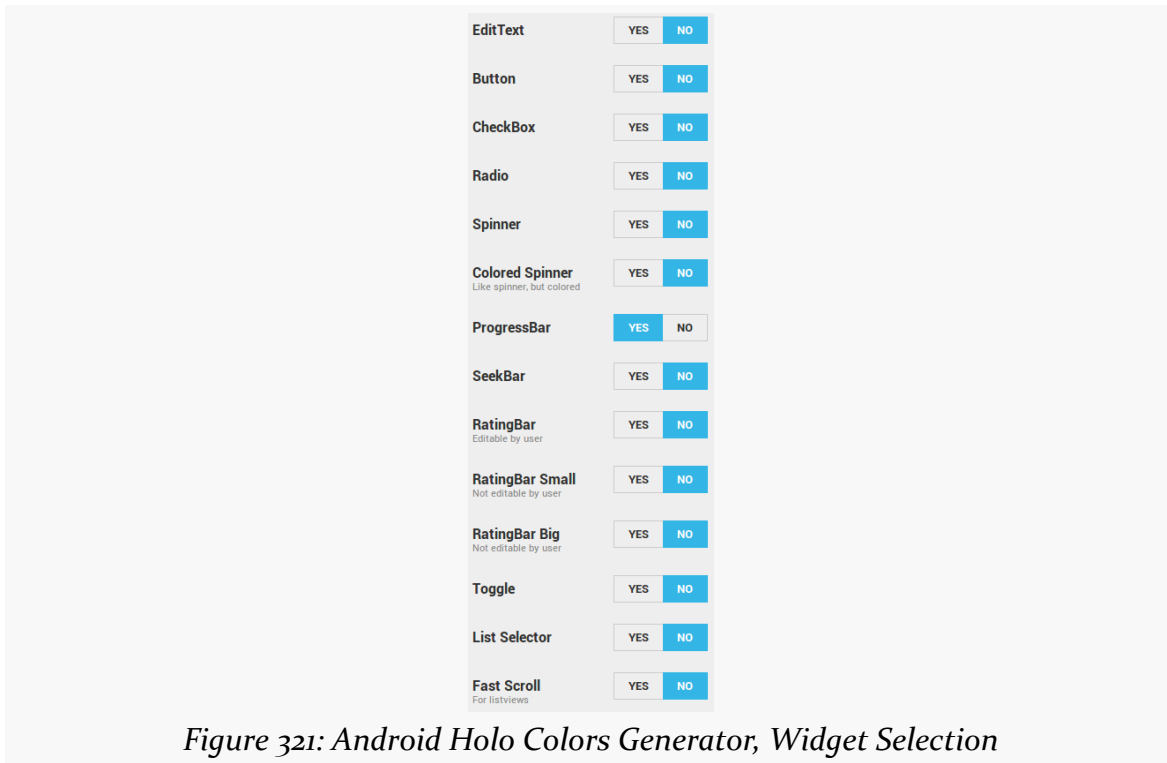


Figure 321: Android Holo Colors Generator, Widget Selection

Then, the generator will create a ZIP file that you can download that contains the generated resources for your custom styles:

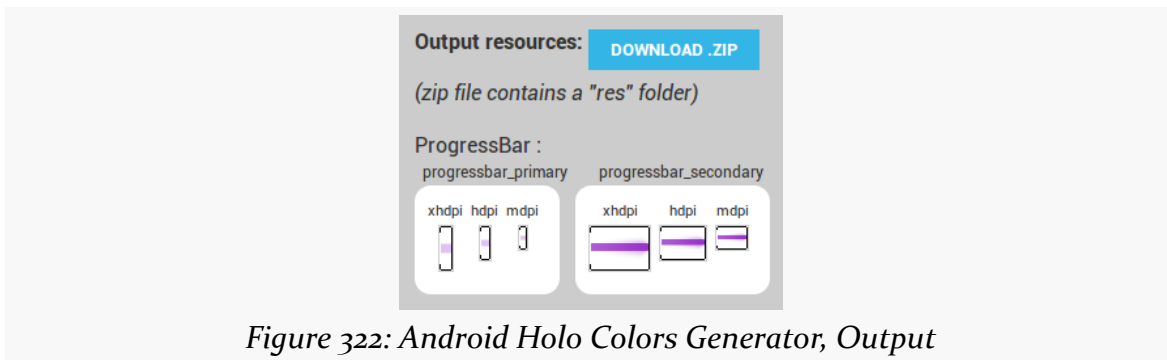


Figure 322: Android Holo Colors Generator, Output

The Progress/Styled project contains the files generated by the generator, replacing the original style resources. Note that the generator does not create a .DarkActionBar version of the style resource, so the values-v14 resource directory in the project has one hand-crafted based upon a regular generated style resource.

Our manifest points to our AppTheme as being how we wish to style widgets in this application:

## PROGRESS INDICATORS

---

```
<manifest xmlns:android="http://schemas.android.com/apk/res/android"
    package="com.commonware.android.progress"
    android:versionCode="1"
    android:versionName="1.0">

    <uses-sdk
        android:minSdkVersion="8"
        android:targetSdkVersion="15"/>

    <application
        android:icon="@drawable/ic_launcher"
        android:label="@string/app_name"
        android:theme="@style/AppTheme">
        <activity
            android:name=".MainActivity"
            android:label="@string/title_activity_main">
            <intent-filter>
                <action android:name="android.intent.action.MAIN"/>

                <category android:name="android.intent.category.LAUNCHER"/>
            </intent-filter>
        </activity>
    </application>
</manifest>
```

That theme, defined in `apptheme_themes.xml`, points to style resources for horizontal `ProgressBar` widgets:

```
<?xml version="1.0" encoding="utf-8"?>

<!-- Generated (in part) with http://android-holo-colors.com -->
<resources xmlns:android="http://schemas.android.com/apk/res/android">

    <style name="AppTheme" parent="android:Theme.Holo.Light.DarkActionBar">

        <item name="android:progressBarStyleHorizontal">@style/
ProgressBarAppTheme</item>

    </style>
</resources>
```

The `ProgressBarAppTheme` style resource is defined in a separate `apptheme_styles.xml` resource:

```
<?xml version="1.0" encoding="utf-8"?>

<!-- Generated with http://android-holo-colors.com -->
<resources xmlns:android="http://schemas.android.com/apk/res/android">

    <style name="ProgressBarAppTheme"
```

## PROGRESS INDICATORS

---

```
parent="android:Widget.Holo.Light.ProgressBar.Horizontal">
    <item name="android:progressDrawable">@drawable/
progress_horizontal_holo_light</item>
    <item name="android:indeterminateDrawable">@drawable/
progress_indeterminate_horizontal_holo_light</item>
</style>
</resources>
```

Here, we say that we want the `android:progressDrawable` property to be a `progress_horizontal_holo_light` drawable resource. We also set the `android:indeterminateDrawable` property — used for indeterminate bars — to a `progress_indeterminate_horizontal_holo_light` drawable resource.

Those are defined as XML-based drawables, in the `res/drawable/` directory in the project. The `progress_horizontal_holo_light` resource is defined as:

```
<?xml version="1.0" encoding="utf-8"?>
<!-- Copyright (C) 2010 The Android Open Source Project

Licensed under the Apache License, Version 2.0 (the "License");
you may not use this file except in compliance with the License.
You may obtain a copy of the License at

    http://www.apache.org/licenses/LICENSE-2.0

Unless required by applicable law or agreed to in writing, software
distributed under the License is distributed on an "AS IS" BASIS,
WITHOUT WARRANTIES OR CONDITIONS OF ANY KIND, either express or implied.
See the License for the specific language governing permissions and
limitations under the License.
-->
<layer-list xmlns:android="http://schemas.android.com/apk/res/android">
    <item android:id="@android:id/background"
        android:drawable="@drawable/progress_bg_holo_light" />
    <item android:id="@android:id/secondaryProgress">
        <scale android:scaleWidth="100%"
            android:drawable="@drawable/progress_secondary_holo" />
    </item>
    <item android:id="@android:id/progress">
        <scale android:scaleWidth="100%"
            android:drawable="@drawable/progress_primary_holo" />
    </item>
</layer-list>
```

## PROGRESS INDICATORS

---

The generator creates our `LayerListDrawable` resource with our three layers, each pointing to a nine-patch PNG file (with different versions for different densities) that contains our desired custom color. The `progress` and `secondaryProgress` layers use [ScaleDrawable definitions](#) to ensure that the images are measured against the complete width of the background layer, which in turn will be sized according to the size of the `ProgressBar` itself.

We will take a look at the `progress_indeterminate_horizontal_holo_light` drawable resource in [the next section](#).

Note that you could skip the custom theme and style if you wished, and simply add the `android:progressDrawable` attribute to the `ProgressBar` widget definition in its layout XML resource.

Regardless, the result is that our progress bars have the desired purple color scheme:



*Figure 323: Custom ProgressBar Style, Primary and Secondary*

Also, you can have your `LayerListDrawable` use `ShapeDrawable` layers, to avoid creating nine-patch PNG files, if you prefer, using a resource like this:

```
<?xml version="1.0" encoding="utf-8"?>
<layer-list xmlns:android="http://schemas.android.com/apk/res/android">
  <item android:id="@android:id/background">
    <shape>
      <stroke android:width="1dip" android:color="#FF333333" />
      <gradient
        android:startColor="#FF9C9E9C"
        android:centerColor="#FF5A5D5A"
        android:centerY="0.71"
        android:endColor="#FF6B716B"
        android:angle="270"
      />
    </shape>
  </item>
  <item android:id="@android:id/secondaryProgress">
    <clip>
      <shape>
        <stroke android:width="1dip" android:color="#FF333333" />
        <gradient
          android:startColor="#4cffffff"
          android:centerColor="#4cE7E7E7"
          android:centerY="0.71"
        />
      </shape>
    </clip>
  </item>
</layer-list>
```

## PROGRESS INDICATORS

---

```
        android:endColor="#4cFFBFF"
        android:angle="270"
    />
</shape>
</clip>
</item>
<item android:id="@android:id/progress">
    <clip>
        <shape>
            <stroke android:width="1dip" android:color="#FF333333" />
            <gradient
                android:startColor="#FFFFFFF"
                android:centerColor="#FFE7E7E7"
                android:centerY="0.71"
                android:endColor="#FFFBFF"
                android:angle="270"
            />
        </shape>
    </clip>
</item>
</layer-list>
```

### Changing the Indeterminate Animation

Similarly, for indefinite progress “bars”, changing the progress drawable will let you change the way they look. However, in this case, the drawable also needs to implement the animation itself. You can accomplish this either by using an [AnimationDrawable](#) or by using some other type of drawable wrapped in an animation, such as [a ShapeDrawable wrapped in a <rotate> animation](#).

For example, the custom theme created by the Android Holo Colors Generator assigns the following drawable resource to `android:indeterminateDrawable` in the theme:

```
<?xml version="1.0" encoding="utf-8"?>
<!--
/*
** Copyright 2011, The Android Open Source Project
**
** Licensed under the Apache License, Version 2.0 (the "License");
** you may not use this file except in compliance with the License.
** You may obtain a copy of the License at
**
**     http://www.apache.org/licenses/LICENSE-2.0
**
** Unless required by applicable law or agreed to in writing, software
** distributed under the License is distributed on an "AS IS" BASIS,
** WITHOUT WARRANTIES OR CONDITIONS OF ANY KIND, either express or implied.
** See the License for the specific language governing permissions and
** limitations under the License.
-->
```



## PROGRESS INDICATORS

---

```
*/
-->
<animation-list
    xmlns:android="http://schemas.android.com/apk/res/android"
    android:oneshot="false">
    <item android:drawable="@drawable/progressbar_indeterminate_holo1"
android:duration="50" />
    <item android:drawable="@drawable/progressbar_indeterminate_holo2"
android:duration="50" />
    <item android:drawable="@drawable/progressbar_indeterminate_holo3"
android:duration="50" />
    <item android:drawable="@drawable/progressbar_indeterminate_holo4"
android:duration="50" />
    <item android:drawable="@drawable/progressbar_indeterminate_holo5"
android:duration="50" />
    <item android:drawable="@drawable/progressbar_indeterminate_holo6"
android:duration="50" />
    <item android:drawable="@drawable/progressbar_indeterminate_holo7"
android:duration="50" />
    <item android:drawable="@drawable/progressbar_indeterminate_holo8"
android:duration="50" />
</animation-list>
```

Hence, every horizontal indeterminate ProgressBar will use that AnimationDrawable. The individual images in the animation are PNG files, with different versions for different densities.

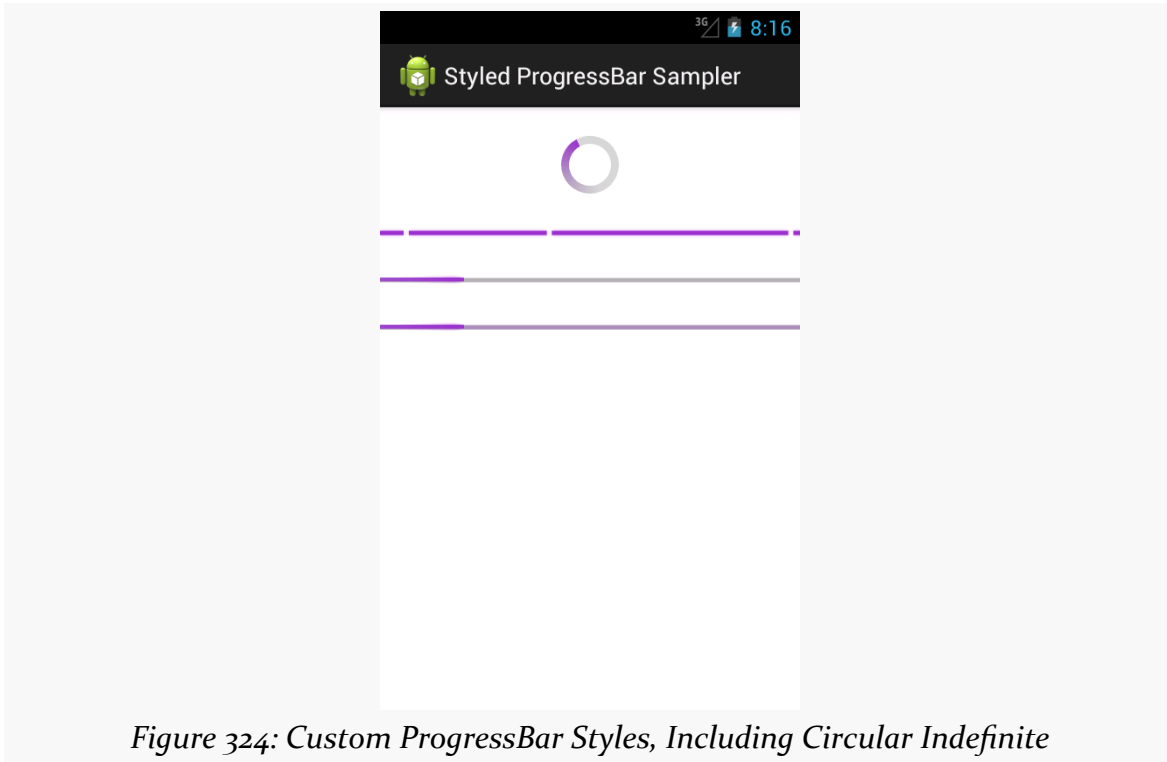
Circular ProgressBar widgets also need a custom progress drawable, though obviously the image will need to be circular, not a bar. You can certainly use an AnimationDrawable for this, or you can use a ShapeDrawable, such as the res/drawable/progress\_circular.xml resource shown below:

```
<?xml version="1.0" encoding="utf-8"?>
<rotate xmlns:android="http://schemas.android.com/apk/res/android"
    android:fromDegrees="0"
    android:pivotX="50%"
    android:pivotY="50%"
    android:toDegrees="360">

    <shape
        android:innerRadiusRatio="3"
        android:shape="ring"
        android:thicknessRatio="8"
        android:useLevel="false">
        <gradient
            android:centerColor="#4c737373"
            android:centerY="0.50"
            android:endColor="#ff9933cc"
            android:startColor="#4c737373"
            android:type="sweep"
            android:useLevel="false" />
    </shape>
</rotate>
```

```
</shape>  
</rotate>
```

Here, we have a ring `ShapeDrawable`, with a certain thickness and radius, filled with a gradient. Half of the fill is actually a solid color (`#4c737373`), as the start and center colors are the same. The other half is a sweep gradient from the starting color to the same purple shade that is used by the other bar styles. This ring is then wrapped in a `rotate` animation. This yields a simple gradient-filled ring, that rotates smoothly to indicate progress:



*Figure 324: Custom ProgressBar Styles, Including Circular Indefinite*

Note that the Android Holo Colors Generator does not generate circular indefinite `ProgressBar` resources as of the time of this writing.

## Progress Dialogs

One use of a `ProgressBar` is to have it wrapped in a `ProgressDialog`. Like all dialogs, `ProgressDialog` is modal, preventing the user from interacting with an underlying activity while the dialog is displayed. From a UI design standpoint, a `ProgressDialog` is an easy way to temporarily show progress without having to find

## PROGRESS INDICATORS

---

a spot for a `ProgressBar` widget somewhere in the UI. Also, since usually there are things in the activity that are dependent upon the work being done in the background, having the dialog in place prevents anyone from trying to use things that are not yet ready.

However, modal dialogs are not a great design approach, as they aggressively limit the user's options. `ProgressDialog` is perhaps the worst in this regard, as the user can do nothing except wait. While *part* of your app may not yet be ready, other parts surely are, such as reading the documentation, or adjusting settings, or clicking on your ad banners. Hence, using *anything* else other than `ProgressDialog`, while perhaps a bit more work, will be an improvement in the usability of your app.

That being said, let us see how to set up a `ProgressDialog`. The [Progress/Dialog](#) sample project is a near-clone of the [Dialogs/DialogFragment](#) sample project from [the chapter on dialogs](#). The only difference is the `onCreateDialog()` method of our `DialogFragment`, where we directly create a `ProgressDialog` instead of using an `AlertDialog.Builder` to create an `AlertDialog` as before:

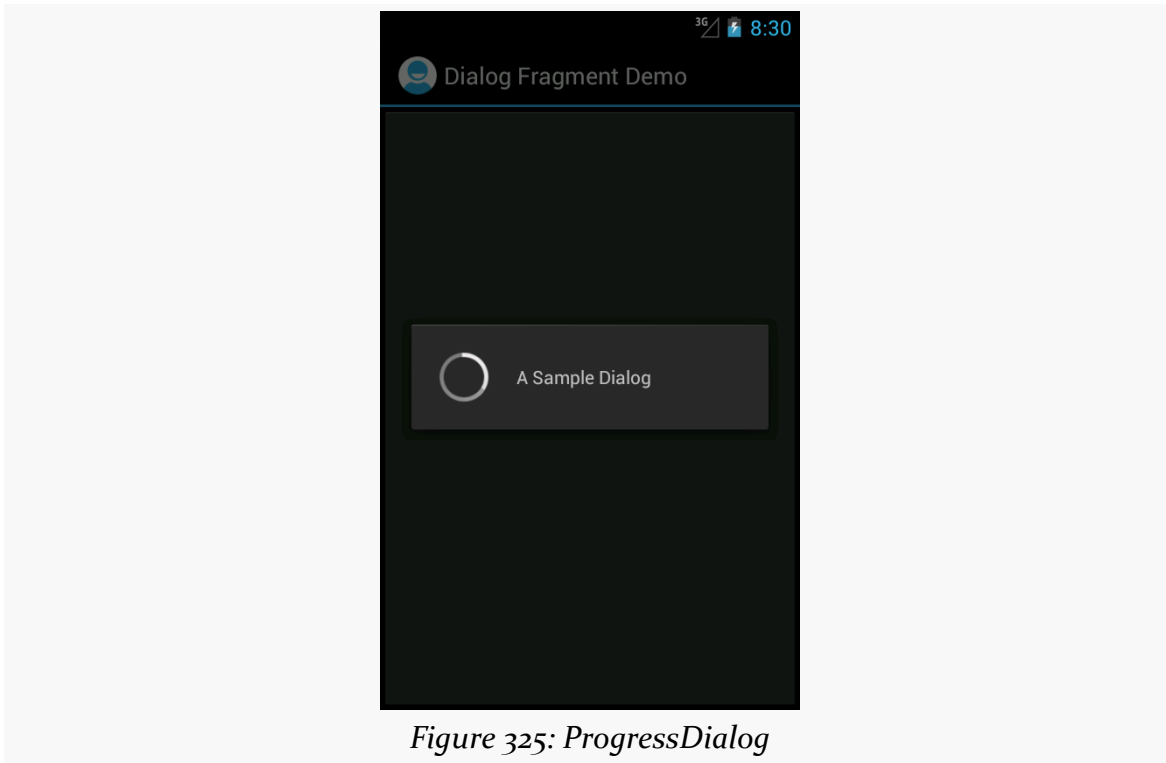
```
@Override
public Dialog onCreateDialog(Bundle savedInstanceState) {
    ProgressDialog dlg=new ProgressDialog(getActivity());

    dlg.setMessage(getActivity().getString(R.string.dlg_title));
    dlg.setIndeterminate(true);
    dlg.setProgressStyle(ProgressDialog.STYLE_SPINNER);

    return(dlg);
}
```

We create the `ProgressDialog` via its constructor, set the message explaining what we are waiting for via `setMessage()`, indicate that the `ProgressBar` should be an indeterminate one via `setIndeterminate()`, and indicate that we want a circular “spinner” `ProgressBar` rather than a horizontal one by calling `setProgressStyle(ProgressDialog.STYLE_SPINNER)`. There are a variety of other things you could configure on the `ProgressDialog` if desired, and `ProgressDialog` inherits from `AlertDialog`, so some things you could configure on an `AlertDialog` will also be available on the `ProgressDialog`.

The result is a dialog that you may have seen from other apps in Android:



*Figure 325: ProgressDialog*

## Title Bar and Action Bar Progress Indicators

Another place to let users know that you are doing something on their behalf is to put a progress indicator in the title bar or action bar of your activity. This avoids your having to put an indeterminate `ProgressBar` somewhere in your activity's UI. It is also very simple to set up, as we can see in the [Progress/TitleBar](#) sample project.

```
package com.commonware.android.titleprog;

import android.app.Activity;
import android.os.Bundle;
import android.view.Window;

public class MainActivity extends Activity {
    @Override
    public void onCreate(Bundle savedInstanceState) {
        getWindow().requestFeature(Window.FEATURE_INDETERMINATE_PROGRESS);
        super.onCreate(savedInstanceState);

        setContentView(R.layout.activity_main);
        setProgressBarIndeterminateVisibility(true);
    }
}
```

## PROGRESS INDICATORS

---

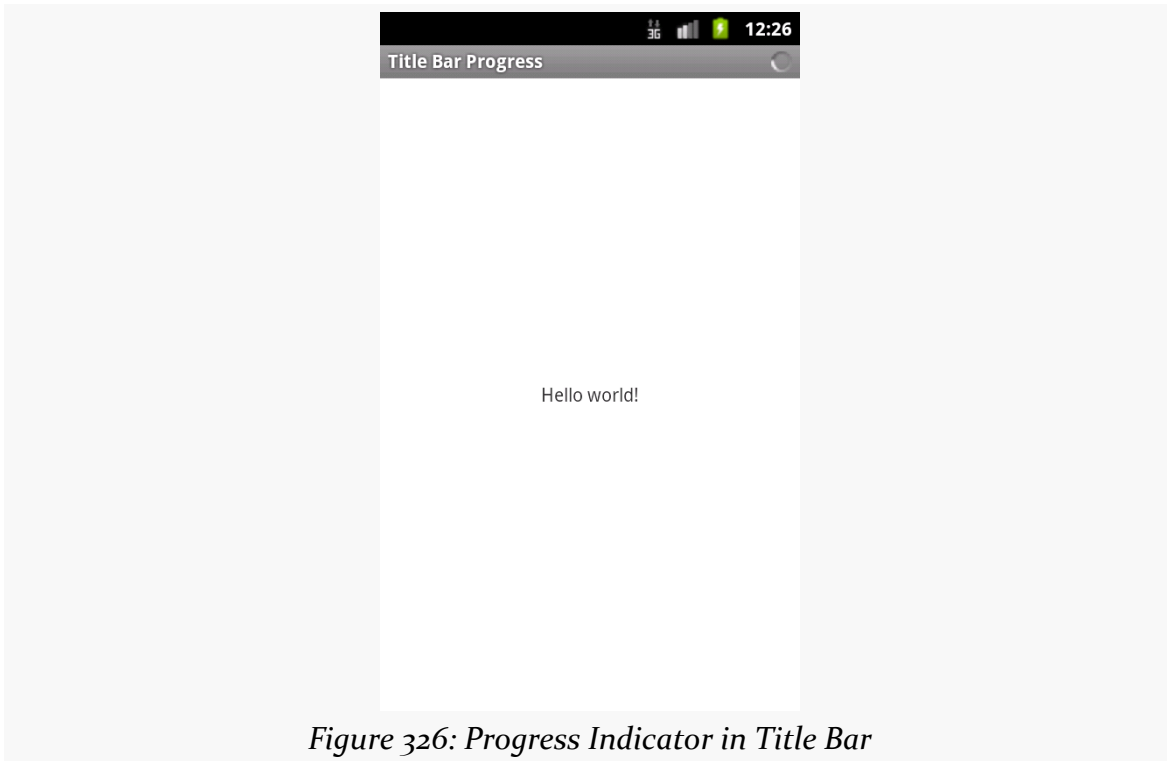
Up front, as the first thing that you do in your `onCreate()` call, you need to call:

```
getWindow().requestFeature(Window.FEATURE_INDETERMINATE_PROGRESS);
```

This tells Android to reserve space in your title bar or action bar for an indeterminate progress indicator, though the indicator does not appear at this point.

Later on, when you want the indicator to actually appear, call `setProgressBarIndeterminateVisibility(true)` on your activity, and later call `setProgressBarIndeterminateVisibility(false)` to make the indicator go away.

This particular application has `android:targetSdkVersion` set to 11 or higher, but it is not using `ActionBarSherlock`. Hence, when you run it on an older Android environment, you get a classic title bar with the progress indicator on the right:



*Figure 326: Progress Indicator in Title Bar*

When you have an action bar, you get the same basic effect, albeit with a larger indicator to match the larger bar:

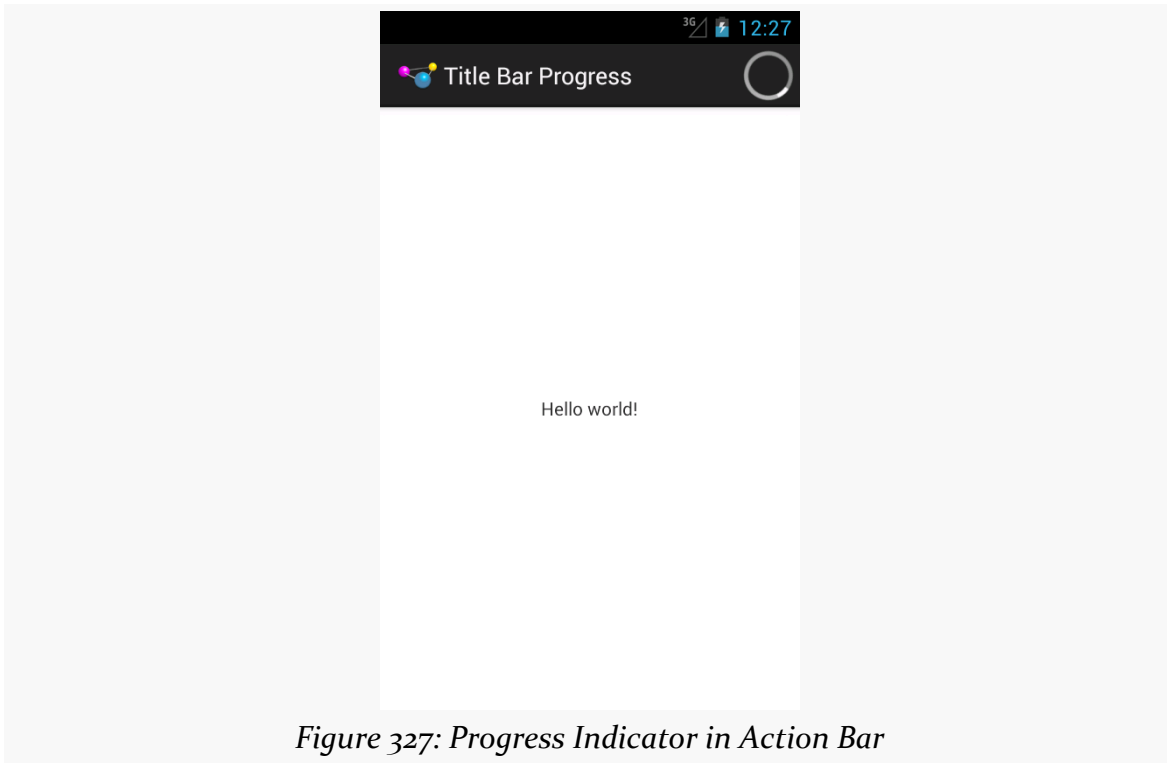


Figure 327: Progress Indicator in Action Bar

Now, you will notice a slightly unusual structure to the `onCreate()` method in the above code listing. Normally, the call to `super.onCreate()` is the very first thing that you want to do. And, ordinarily, you would only need to call `requestFeature()` on your window before the call to `setContentView()`. However, Jake Wharton [has indicated](#) that the code sequence shown above is the correct one when using `ActionBarSherlock` and its progress indicator.

## Action Bar Refresh-and-Progress Items

One common pattern in an Android application is to have some sort of “refresh” action bar item, that causes you to do some work once it is tapped. For example, the Gmail app has a refresh action bar item that goes and checks for new email.

A handy way to visually represent that work is to replace the static action bar item icon with some sort of circular progress indicator while that work is going on. This can not only tell the user that we are working on their request, but it can also convey to the user that tapping it *again* is unlikely to be especially useful.

To see how this works, take a look at the [Progress/ActionBar](#) sample project.

---

## PROGRESS INDICATORS

---

This is a trimmed-down version of the book's [original action bar sample](#). It retains the “refresh” action bar item but gets rid of the others. The “refresh” action bar item will not actually refresh anything, but it will pretend to do work for a few seconds, replacing itself with a small indeterminate `ProgressBar` while that is going on.

In `onCreateOptionsMenu()` of our activity, we do the normal inflate-the-menu-resource work, plus hold onto the `MenuItem` associated with our refresh option:

```
@Override
public boolean onCreateOptionsMenu(Menu menu) {
    new MenuInflater(this).inflate(R.menu.actions, menu);

    refresh=menu.findItem(R.id.refresh);

    return(super.onCreateOptionsMenu(menu));
}
```

In `onOptionsItemSelected()`, we call a private `refresh()` method if the user taps on our refresh action bar item:

```
@Override
public boolean onOptionsItemSelected(MenuItem item) {
    if (item.getItemId() == R.id.refresh) {
        refresh();

        return(true);
    }

    return(super.onOptionsItemSelected(item));
}
```

That `refresh()` method is where we do the work to change our action bar item to a progress indicator and pretend to do the fake work:

```
private void refresh() {
    refresh.setActionView(R.layout.refresh);

    getListView().postDelayed(new Runnable() {
        public void run() {
            refresh.setActionView(null);
        }
    }, 5000);
}
```

We call `setActionView()` to *replace* the default action bar toolbar button with a custom `View`, inflated from `res/layout/refresh.xml`:

## PROGRESS INDICATORS

---

```
<?xml version="1.0" encoding="utf-8"?>
<LinearLayout xmlns:android="http://schemas.android.com/apk/res/android"
    style="?attr/actionButtonStyle"
    android:layout_width="wrap_content"
    android:layout_height="wrap_content"
    android:gravity="center">

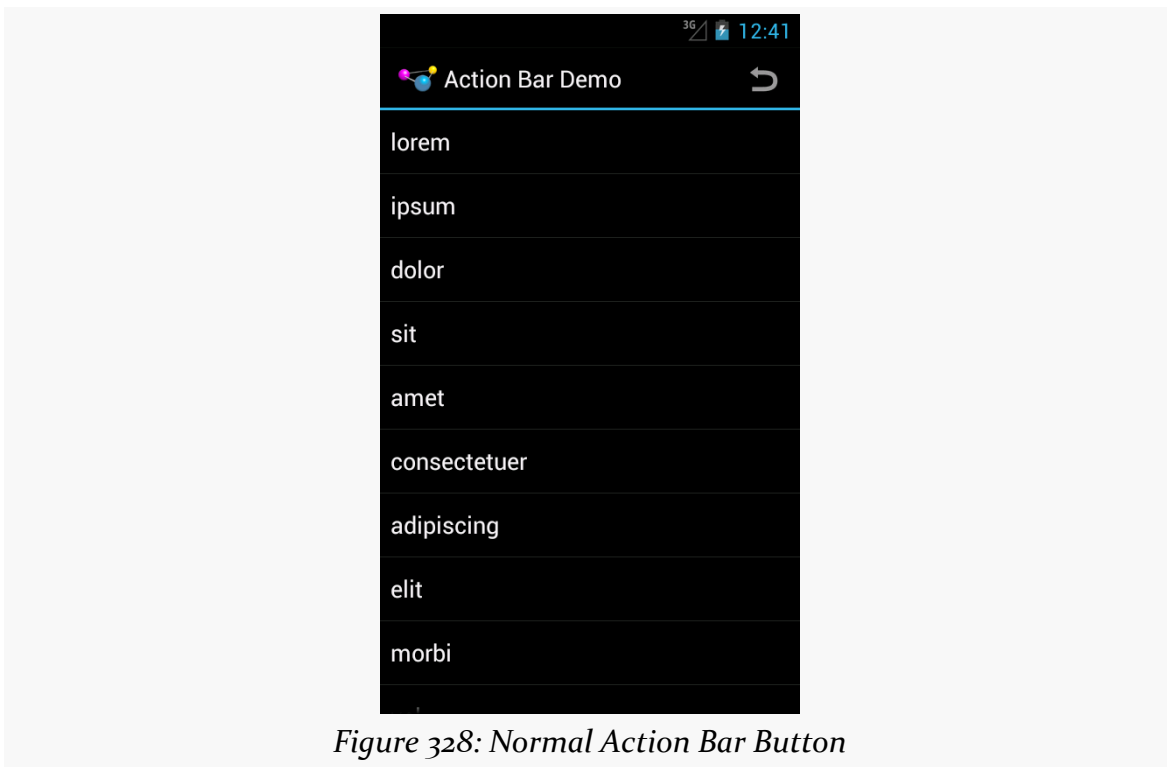
    <ProgressBar
        style="@android:style/Widget.ProgressBar.Small"
        android:layout_width="wrap_content"
        android:layout_height="wrap_content"/>

</LinearLayout>
```

This is a `LinearLayout`, styled to match an action button, with a small `ProgressBar` widget in the center.

We then delay for 5000 millisecond (pretending to do work) before calling `setActionView(null)` to remove our inflated layout and return to the normal action bar button.

So while the activity starts with a conventional button...



*Figure 328: Normal Action Bar Button*



...once we tap it, the button is replaced with our progress indicator:



*Figure 329: Progress Indicator Replacing Action Bar Button*

The on-click listener that the action bar puts on the button remains on the button — we do not get control when the user taps on the `ProgressBar`, nor does the user get any visual feedback suggesting that such taps have meaning. Hence, while the refresh is going on, the user cannot request another refresh operation. If, for some reason, you actually want that behavior, you could set that up yourself with your inflated layout and event listeners on the widgets.

This sample implementation is not complete — for example, we should track whether our work is going on and toggle the action bar item to the progress indicator on a configuration change. But the basics are there and, as you can see, are fairly simple.

## Direct Progress Indication

Sometimes, the best way to let the user know about updates is to simply update the data in place. Rather than have some separate indicator, let the core UI itself convey the work being done.

## PROGRESS INDICATORS

---

We saw this in [the chapter on threads](#), where we populated a `ListView` in “real time” as we loaded in data into its adapter. Other variations on this theme include:

- Updating a page count `TextView` to show the number of downloaded pages, while the user is reading earlier pages, perhaps with some sort of style (e.g., italics) or color coding (e.g., red) to indicate data that is being loaded.
- Simply disabling the buttons, action bar items, and other ways that the user could navigate to a point in your app where you need the data that is being loaded in the background. The key here is to make sure that users understand *why* those items are disabled, and sometimes that is not obvious. Hence, while this step may be necessary, it is often tied in with progress indicators in the title bar or action bar or other means of indicating to the user the *reason* they cannot perform certain operations.



# Advanced Notifications

---

Notifications are those icons that appear in the status bar (or system bar on tablets), typically to alert the user of something that is going on in the background or has completed in the background. Many apps use them, to let the user know of new email messages, calendar reminders, and so on. Foreground services, such as music players, also use notifications, to tell the OS that they are part of the foreground user experience and to let the user rapidly return to the apps to turn the music off.

There are other tricks available with the Notification object beyond those originally discussed [in an earlier chapter](#).

## Prerequisites

Understanding this chapter requires that you have read the core chapters of this book, particularly [the chapter on basic notifications](#) and [the section on RemoteViews](#) in [the chapter on basic app widgets](#).

## Custom Views: or How Those Progress Bars Work

Some applications have specific tasks that take a chunk of time. The most common situation for these is a download — while downloading a file should not take forever, it may take several seconds or minutes, depending on the size of the file and the possible download speed.

You may have noticed that some applications, such as the Android Market, have a Notification for a download that shows the progress of the download itself. Visually, it's obvious how they accomplish this: they use a `ProgressBar`. But normally you create Notification objects with just a title and description as text. How do they

get the `ProgressBar` in there? And, perhaps more importantly, how are they continuously updating it?

This section will explain how that works, along with a related construct added in Android 3.0: the custom ticker.

### Custom Content

When you specify a title and a description for a `Notification`, you are implicitly telling Android to use a stock layout for the structure of the `Notification` object's entry in the notification drawer. However, instead, you can provide Android with the layout to use and the contents of all the widget, by means of a `RemoteViews`. In other words, by using the same techniques that you use to create [app widgets](#), you can create tailored notification drawer content. Just create the `RemoteViews` and put it in the `contentView` data member of the `Notification`.

To update the notification drawer content — such as updating a `ProgressBar` to show download progress — you update your `RemoteViews` in your `Notification` and re-raise the `Notification` via a call to `notify()`. Android will apply your revised `RemoteViews` to the notification drawer content, and the user will see the changed widgets. However, you will also want to remove requested features from the `Notification` that you do not want to occur every time you update the `RemoteViews`. For example, if you keep the `tickerText` in place, every time you update the `RemoteViews`, the ticker text will be re-displayed, which can get annoying.

We will see an example of this in action [later in this chapter](#).

### Custom Tickers

Traditionally, the “ticker” is a piece of text that is placed in the status bar when the `Notification` is raised, so that if the user happens to be looking at the phone at that moment (or glances at it quickly, cued by a vibration or ringtone), they get a bit more contextual information about the `Notification` and why it is there.

On API Level 11+ tablets, you also have the option of creating a custom ticker, once again using a `RemoteViews`. Create the `RemoteViews` to be what you want to show as the ticker, and assign it to the `tickerView` data member of the `Notification`. On devices with room (e.g., tablets), your `RemoteViews` will be displayed instead of the contents of the `tickerText` data member. However, it is a good idea to also fill in the `tickerText` value, for devices that elect to show that instead of your custom view.

## Seeing It In Action

To see custom tickers and custom content in a complete project, take a peek at the [Notifications/HCNotifyDemo](#) sample project. This is perhaps the smallest possible project that uses all of these features, so do not expect much elaborate business logic.

### The Activity

The launcher icon for this application is tied to an activity named `HCNotifyDemoActivity`. All it does is spawn a background service named `SillyService`, that will simulate doing real work in the background and maintaining a Notification along the way:

```
package com.commonware.android.hcnotify;

import android.app.Activity;
import android.content.Intent;
import android.os.Bundle;
import com.commonware.android.hcnotify.R;

public class HCNotifyDemoActivity extends Activity {
    @Override
    public void onCreate(Bundle savedInstanceState) {
        super.onCreate(savedInstanceState);
        setContentView(R.layout.main);

        startService(new Intent(this, SillyService.class));

        finish();
    }
}
```

### The IntentService

`SillyService` is an `IntentService`, to take advantage of the two key features of an `IntentService`: the supplied background thread, and automatically being destroyed when the work being done in the background is finished.

Since `SillyService` is an `IntentService`, and `IntentService` requires a constructor, supplying a display name for the service, we oblige:

```
public SillyService() {
    super("SillyService");
}
```

All of the rest of the business logic is in `onHandleIntent()`, which will be described in pieces below.

### The Builder

In theory, `SillyService` is going to do some real long-running work, updating a `ProgressBar` in a `Notification` along the way. To keep the example simple — and not to violate “truth in advertising” laws given the service’s name — `SillyService` will emulate doing real work by sleeping.

Hence, the first thing `SillyService` does in `onHandleIntent()` is get a `NotificationManager` and a `NotificationCompat.Builder`, then configure the builder to get the base `Notification` to use:

```
NotificationManager
mgr=(NotificationManager)getSystemService(NOTIFICATION_SERVICE);
NotificationCompat.Builder builder=new NotificationCompat.Builder(this);

builder
    .setContent(buildContent(0))
    .setTicker(getText(R.string.ticker), buildTicker())
    .setContentIntent(buildContentIntent())
    .setLargeIcon(buildLargeIcon())
    .setSmallIcon(R.drawable.ic_stat_notif_small_icon)
    .setOngoing(true);

Notification notif=builder.build();
```

Configuring the builder, in this case, involves calling the following setters:

1. `setContent()`, to provide the `RemoteViews` for the notification drawer entry, here delegated to a `buildContent()` method we will examine in a bit
2. `setTicker()`, to provide the material to be displayed as the ticker, in this case using a `setTicker()` variant that takes a `CharSequence` (e.g., a `String`, or the result of `getText()` on a string resource ID) and a `RemoteViews` to use in cases where the device supports custom tickers (delegated here to `buildTicker()`)
3. `setContentIntent()`, to provide the `PendingIntent` to be invoked if the user taps on our custom content `RemoteViews`, here delegated to `buildContentIntent()`
4. `setLargeIcon()`, used on some devices for a larger representation of our notification icon for use in tickers and non-custom notification drawer contents, here delegated to `buildLargeIcon()`

## ADVANCED NOTIFICATIONS

---

5. `setSmallIcon()`, use for the status bar/system bar icon and, on some devices, for non-custom notification drawer contents
6. `setOngoing()`, which sets `FLAG_ONGOING_EVENT`, preventing this Notification from being deleted by the user

Finally, we call `build()` to retrieve the Notification object as configured by the builder. Note that previous versions of `NotificationBuilder` used `getNotification()` instead of `build()`, but `getNotification()` is now officially deprecated.

### The ProgressBar

Our `buildContent()` method just returns a `RemoteViews` object:

```
private RemoteViews buildContent(int progress) {
    RemoteViews content=new RemoteViews(this.getPackageName(),
                                       R.layout.content);

    return(content);
}
```

The `RemoteViews` object, in turn, is based on a trivial layout (`res/layout/content.xml`) containing a `ProgressBar`:

```
<ProgressBar xmlns:android="http://schemas.android.com/apk/res/android"
    android:id="@android:id/progress"
    style="?android:attr/progressBarStyleHorizontal"
    android:layout_width="match_parent"
    android:layout_height="wrap_content"
    android:indeterminate="false">
</ProgressBar>
```

The simplest way to update a `ProgressBar` in a Notification is to simply hold onto the Notification object and update the `ProgressBar` in the `RemoteViews` as needed.

`SillyService` takes this approach, looping 20 times for 1000-millisecond naps, updating the `ProgressBar` on each pass of the loop:

```
for (int i=0;i<20;i++) {
    notif.contentView.setProgressBar(android.R.id.progress,
                                    100, i*5, false);
    mgr.notify(NOTIFICATION_ID, notif);

    if (i==0) {
        notif.tickerText=null;
    }
}
```



## ADVANCED NOTIFICATIONS

---

```
    notif.tickerView=null;
  }

  SystemClock.sleep(1000);
}
```

You update the progress of a `ProgressBar` by calling `setProgressBar()` on the `RemoteViews`, and you get your content `RemoteViews` from the `contentView` data member of the configured `Notification`. `SillyService` has the `ProgressBar` run from 0 to 100 and sets the progress to be 5 times our loop counter. Each time we update the `RemoteViews`, we call `notify()` to raise or update the `Notification`.

The key is that the first time we do this, we want to display our ticker, but not every time the `ProgressBar` updates, as that would really aggravate the user. So, after we raise the `Notification` in the first pass of our loop, we set the `tickerText` and `tickerView` data members of the `Notification` to `null`, to suppress further tickers from being displayed.

When the loop is finished, we just `cancel()` the `Notification`, to remove it from the screen.

### The Rest of the Story

The `buildTicker()` method also returns a `RemoteViews`:

```
private RemoteViews buildTicker() {
    RemoteViews ticker=new RemoteViews(this.getPackageName(),
                                     R.layout.ticker);

    ticker.setTextViewText(R.id.ticker_text,
                          getString(R.string.ticker));

    return(ticker);
}
```

It, in turn, is based off of a `res/layout/ticker.xml` resource:

```
<TextView xmlns:android="http://schemas.android.com/apk/res/android"
    android:id="@+id/ticker_text"
    android:layout_width="wrap_content"
    android:layout_height="wrap_content"
    android:text="TextView">
</TextView>
```

## ADVANCED NOTIFICATIONS

---

There is nothing requiring the ticker (or the content, for that matter) to be completely static. You might well customize `TextView` or other widgets at runtime with details about the work being done. Here, `buildTicker()` does that via `setTextViewText()`, albeit just pulling in a string resource.

The `buildContentIntent()` method returns a `PendingIntent` to be invoked when the user taps on our `ProgressBar`-laden notification drawer entry. Here, lacking any better ideas and being generally lazy, we return a `PendingIntent` designed to bring up the Settings application:

```
private PendingIntent buildContentIntent() {
    Intent i=new Intent(Settings.ACTION_SETTINGS);

    return(PendingIntent.getActivity(this, 0, i, 0));
}
```

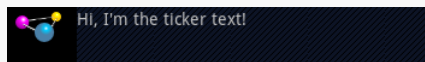
While small icons in a `Notification` must be resources, large icons are bitmaps. Presumably, that is to support the large icon holding contact photos, chat avatars, album art for music players, and whatnot. Hence, `buildLargeIcon()` needs to return a `Bitmap` object. In our case, it is simply a drawable resource, so we use `BitmapFactory` and `decodeResource()` to get a `Bitmap` from the PNG:

```
private Bitmap buildLargeIcon() {
    Bitmap raw=BitmapFactory.decodeResource(getResources(),
                                         R.drawable.icon);

    return(raw);
}
```

## The Results

When we launch `HCNotifyDemoActivity`, which in turns starts up `SillyService`, we initially get our custom ticker on a tablet:



*Figure 330: The custom ticker in our Notification, as seen on a Honeycomb tablet*

Eventually, the ticker vanishes, leaving us with the traditional system bar icon:



*Figure 331: The system bar icon for our Notification, as seen on a Honeycomb tablet*

## ADVANCED NOTIFICATIONS

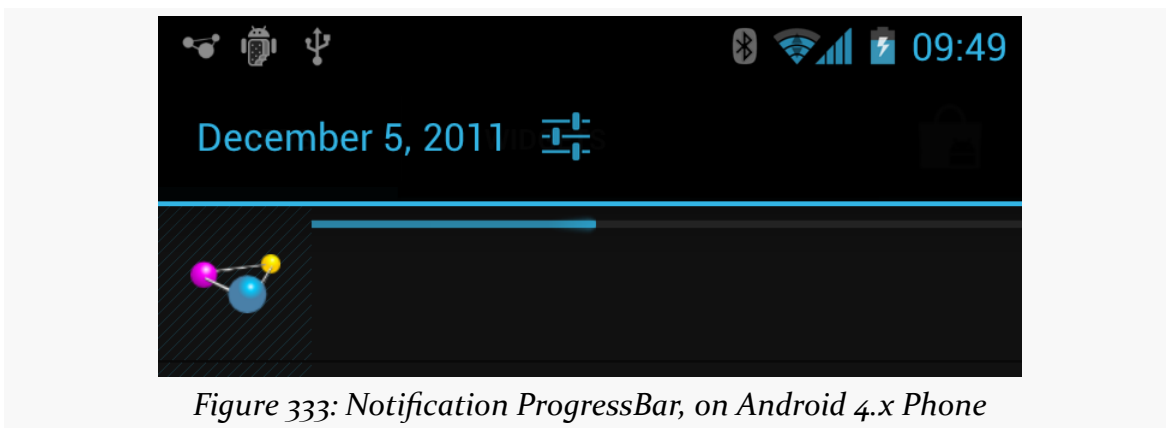
---

Tapping on the icon brings up the notification drawer, with our custom content, including our ProgressBar:



*Figure 332: Notification ProgressBar, on Android 3.x Tablet*

On an Android 4.0 phone, the status bar and ticker are no different than their Android 1.x/2.x counterparts, though we still get our custom content:



*Figure 333: Notification ProgressBar, on Android 4.x Phone*

## Life After Delete

Most of the time, you do not care about your Notification being dismissed by the user from the notification drawer (e.g., pressing the Clear button on Android 1.x/2.x devices). If you do care about the Notification being deleted this way, you can supply a `PendingIntent` in the `deleteIntent` data member of the `Notification` — this will be executed when the user gets rid of your `Notification`. Usually, this will be a `getService()` or `getBroadcast()` `PendingIntent`, to have you do something in the background related to the dismissal. Users are likely to get rather irritated with you if you pop up an activity because they got rid of your `Notification`.

Note that this only works for Notification objects that can be cleared. If you have `FLAG_ONGOING_EVENT` set on the Notification, it will remain on-screen until *you* get rid of it.

### The Mysterious Case of the Missing Number

The Notification class has a number data member. On Android 1.x and 2.x, setting that data member would cause a number to be super-imposed on top of your icon in the status bar. That data member no longer works as of Android 3.0.

However, Notification.Builder has a `setNumber()` method which *does* work on API Level 11 and higher, though with slightly different behavior. Instead of putting the number on top of your status bar icon, the number will appear in your notification drawer entry. This only works if you do not use `setContent()` with Notification.Builder to define your own notification drawer entry layout — in that case, you could put your own number in wherever you would like.



# More Fun with Pagers

---

In earlier chapters, we saw [basic uses of ViewPager](#), along with ways to [show multiple pages at a time on larger screens](#). However, there are other ways to apply ViewPager and integrate it into the rest of your application, some of which we will examine in this chapter.

## Prerequisites

This chapter assumes that you have read the core chapters, particularly the one showing [how to use ViewPager](#). This chapter also assumes that you have read the chapter on [action bar navigation](#).

## ViewPager with Action Bar Tabs

More often than not, if you wish to use tabs in concert with your ViewPager, you will use PagerTabStrip, or perhaps an indicator from the ViewPagerIndicator project, to supply those tabs. Those are designed to integrate cleanly with ViewPager and were demonstrated earlier in this book.

And, as was outlined in the chapter on action bar navigation, while you can request to use tabs in your action bar, those tabs do not necessarily work well — for example, sometimes they will convert into a drop-down list instead.

That being said, perhaps there are scenarios in which you want to use action bar tabs to control pages in a ViewPager. This is certainly possible, though it requires teaching the action bar about the ViewPager *and* teaching the ViewPager about the action bar.

To see what is required, take a look at the [ViewPager/TabPage](#) sample project. This is based on the [ViewPager/Fragments](#) and [ViewPager/Indicator](#) sample projects reviewed in the chapter introducing ViewPager.

As with those projects, our activity hosts a ViewPager, which we intend to populate with EditorFragments by way of a SampleAdapter. None of that has changed in this new sample. However, we do more work in the activity (ViewPagerFragmentDemoActivity) that ties the pager into the action bar.

### Tying Tabs to Pages

When the user taps on a tab, we expect the ViewPager to jump to the associated page, where “the associated page” is based on tab position. For example, tapping the second tab should bring up the second page. To change the current page of a ViewPager, you simply need to call `setCurrentItem()` — we just need to know when to call that and what value to supply as the position.

To do that, as we set up the action bar tabs, we attach the index of the tab as the tab’s tag via `setTag()`:

```
ActionBar bar=getSupportActionBar();
bar.setNavigationMode(ActionBar.NAVIGATION_MODE_TABS);

for (int i=0; i < 10; i++) {
    bar.addTab(bar.newTab()
        .setText("Editor #" + String.valueOf(i + 1))
        .setTabListener(this).setTag(i));
}
```

We also set the activity itself as being the listener, meaning that we have to implement the `TabListener` interface on the activity. That requires three methods to be added: `onTabSelected()`, `onTabReselected()`, and `onTabUnselected()`:

```
@Override
public void onTabSelected(Tab tab, FragmentTransaction ft) {
    Integer position=(Integer)tab.getTag();

    pager.setCurrentItem(position);
}

@Override
public void onTabUnselected(Tab tab, FragmentTransaction ft) {
    // no-op
}

@Override
```

## MORE FUN WITH PAGERS

---

```
public void onTabReselected(Tab tab, FragmentTransaction ft) {  
    // no-op  
}
```

We ignore `onTabReselected()` and `onTabUnselected()`, providing stub implementations because the interface requires them. However, we have a real implementation of `onTabSelected()`, one which grabs the tab's position out of its tag and uses that in the call to `setCurrentItem()` on the `ViewPager`. As a result, if the user chooses a tab — including choosing something from the drop-down that replaces tabs in some circumstances — the pager updates to match.

### Tying Pages to Tabs

Obviously, we needed to have tapping on a tab bring up its associated page. What might be less obvious at the outset is that the reverse is true: we need to select the right tab if the user navigates to another page via swiping in the `ViewPager`. Otherwise, horizontal swipe actions will show a different page than the currently-selected tab would indicate.

Fortunately, this too is relatively easy.

As part of our `ViewPager` setup, we have it send page-scrolled events to our activity via `setOnPageChangeListener()`:

```
pager=(ViewPager)findViewById(R.id.pager);  
pager.setAdapter(new SampleAdapter(getSupportFragmentManager()));  
pager.setOnPageChangeListener(this);
```

That requires our activity to implement the `ViewPager.OnPageChangeListener` interface, which in turn requires three methods:

1. `onPageScrolled()`
2. `onPageScrollStateChanged()`
3. `onPageSelected()`

It is the latter one that we care about — this will be called when the user fully swipes to another page. In our implementation, we simply set the selected tab to the same position:

```
@Override  
public void onPageScrollStateChanged(int arg0) {  
    // no-op  
}
```



---

## MORE FUN WITH PAGERS

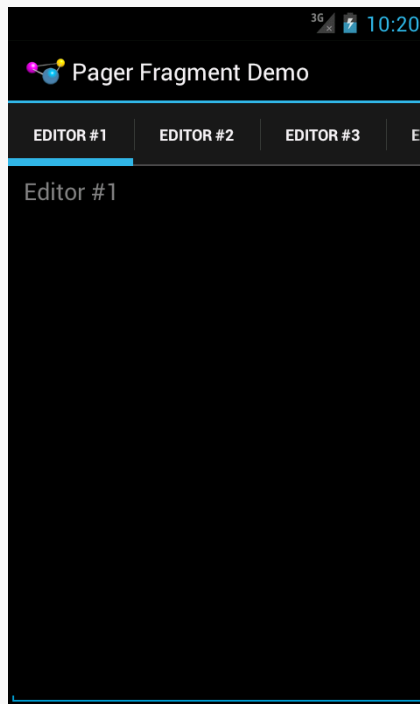
---

```
@Override
public void onPageScrolled(int arg0, float arg1, int arg2) {
    // no-op
}

@Override
public void onPageSelected(int position) {
    getSupportActionBar().setSelectedNavigationItem(position);
}
```

### The Results

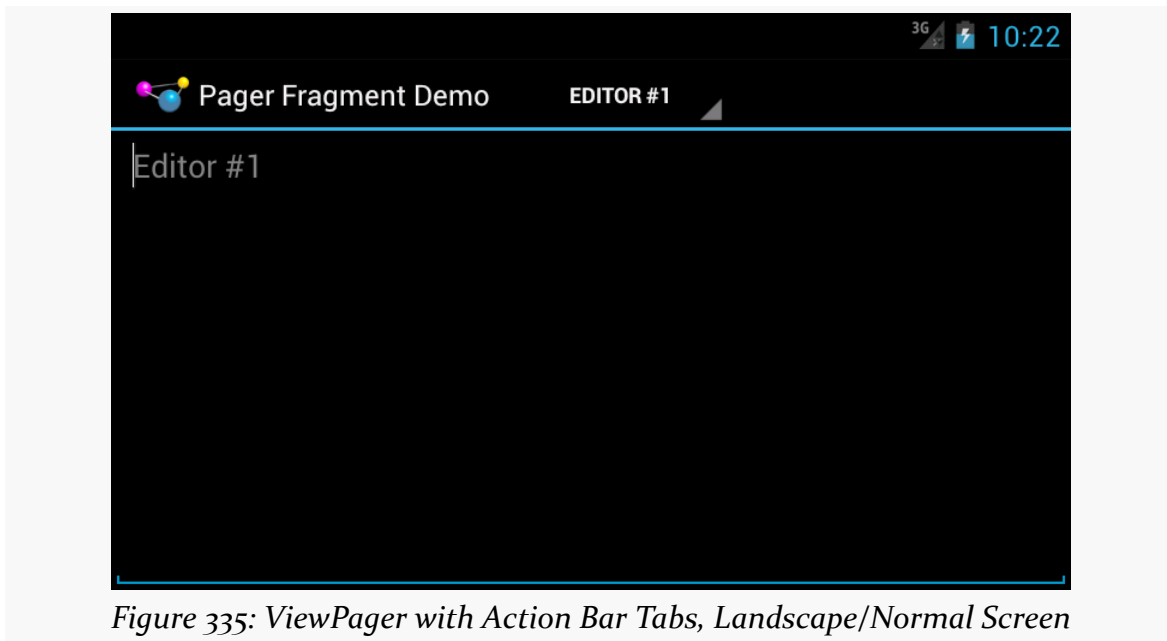
The visual effect, normally, is not that different from using a PagerTabStrip:



*Figure 334: ViewPager with Action Bar Tabs, Portrait/Normal Screen*

The user can swipe the main area to move between pages, with the tabs automatically updating. The user can also tap on a tab to move to that page, or swipe the tabs to reach a tab not presently visible.

However, since these are action bar tabs, not a PagerTabStrip, they will automatically convert into a list-navigation-style Spinner, at various times:



*Figure 335: ViewPager with Action Bar Tabs, Landscape/Normal Screen*

Also, when tabs are “collapsed” into the list navigation mode, [a bug in Android](#) means that swiping the pager does not update the Spinner, as `setSelectedItem()` no longer works there.



# **Focus Management and Accessibility**

As developers, we are very used to creating apps that are designed to be navigated by touch, with users tapping on widgets and related windows to supply input.

However, not all Android devices have touchscreens, and not all Android users use touchscreens.

Internationalization (i18n) and localization (l10n) give you opportunities to expand your user base to audiences beyond your initial set, based on language. Similarly, you can expand your user base by offering support for non-touchscreen input and output. Long-term, the largest user base of these features may be those with televisions augmented by Android, whether via Google TV, OUYA consoles, or whatever. Short-term, the largest user base of these features may be those for whom touchscreens are rarely a great option, such as the blind. Supporting those with unusual requirements for input and output is called *accessibility* (a11y), and represents a powerful way for you to help your app distinguish itself from competitors.

In this chapter, we will first examine how to better handle focus management, and then segue into examining what else, beyond supporting keyboard-based input, can be done in the area of accessibility.

## **Prerequisites**

Understanding this chapter requires that you have read the core chapters and are familiar with the concept of widgets having focus for user input.

### Prepping for Testing

To test focus management, you will need an environment that supports “arrow key” navigation. Here, “arrow key” also includes things like D-pads or trackballs – basically, anything that navigates by key events instead of by touch events.

Examples include:

- The Android emulator, with the `Dpad support hardware` property set to `yes`
- Phones that have actual D-pads, trackballs, arrow keys, or the like
- Television-based Android environments, such as Google TV or the OUYA console
- Devices that have dedicated keyboard accessories, such as the keyboard “slice” available for the ASUS Transformer series of tablets
- A standard Android device accessed via a Bluetooth keyboard, gamepad, or similar sort of pointing device

Hence, even if the emulator will be insufficient for your needs, you should be able to set up a hardware test environment relatively inexpensively. Most modern Android devices support Bluetooth keyboards, and such keyboards frequently can be obtained at low relative cost.

For accessibility beyond merely focus control, you will certainly want to enable TalkBack, via the Accessibility area of the Settings app. This will cause Android to verbally announce what is on the screen, by means of its text-to-speech engine.

On Android 4.0 and higher devices, enabling Talkback will also optionally enable “Explore by Touch”. This allows users to tap on items (e.g., icons in a `GridView`) to have them read aloud via TalkBack, with a double-tap to actually perform what ordinarily would require a single-tap without “Explore by Touch”.

### Controlling the Focus

Android tries its best to have intelligent focus management “out of the box”, without developer involvement. Many times, what it offers is sufficient for your needs. Other times, though, the decisions Android makes are inappropriate:

- Trying to navigate in a certain direction (e.g., right) moves focus to a widget that is not logically what should have the focus

- Focus has other side effects, like showing the soft keyboard on an EditText widget, that is not desirable

Hence, if you feel that you need to take more control over how focus management is handled, you have many means of doing so, covered in this section.

### Establishing Focus

In order for a widget to get the focus, it has to be focusable.

You might think that the above sentence was just a chance for the author to be witty. It was... a bit. But there are actually two types of “focusable” when it comes to Android apps:

- Is it focusable when somebody is using a pointing device or the keyboard?
- Is it focusable in touch mode?

There are three major patterns for the default state of a widget:

1. Some are initially focusable in both cases (e.g., EditText)
2. Some are focusable in non-touch mode but are not focusable in touch mode (e.g., Button)
3. Some are not focusable in either mode (e.g., TextView)

So, when a Button is not focusable in touch mode, that means that while the button will take the focus when the user navigates to it (e.g., via keys), the button will *not* take the focus when the user simply taps on it.

You can control the focus semantics of a given widget in four ways:

- You can use `android:focusable` and `android:focusableInTouchMode` in a layout
- You can use `setFocusable()` and `setFocusableInTouchMode()` in Java

We will see examples of these shortly.

### Requesting (or Abandoning) Focus

By default, the focus will be granted to the first focusable widget in the activity, starting from the upper left. Often times, this is a fine solution.

If you want to have some other widget get the focus (assuming that the widget is focusable, per the section above), you have two choices:

1. Call `requestFocus()` on the widget in question
2. You can give the widget's layout element a child element, named `<requestFocus />`, to stipulate that this widget should be the one to get the focus

Note that this is a child element, not an attribute, as you might ordinarily expect.

For example, let's look at the [Focus/Sampler](#) sample project, which we will use to illustrate various focus-related topics.

Our main activity, creatively named `MainActivity`, loads a layout named `request_focus.xml`, and demonstrates the `<requestFocus />` element:

```
<LinearLayout xmlns:android="http://schemas.android.com/apk/res/android"
    android:layout_width="fill_parent"
    android:layout_height="fill_parent">

    <Button
        android:id="@+id/button1"
        android:layout_width="wrap_content"
        android:layout_height="wrap_content"
        android:text="@string/a_button"/>

    <EditText
        android:id="@+id/editText1"
        android:layout_width="0dp"
        android:layout_height="wrap_content"
        android:layout_weight="1"
        android:contentDescription="@string/first_field"
        android:hint="@string/str_1st_field"
        android:inputType="text"/>

    <EditText
        android:id="@+id/editText2"
        android:layout_width="0dp"
        android:layout_height="wrap_content"
        android:layout_weight="1"
        android:contentDescription="@string/second_field"
        android:hint="@string/str_2nd_field"
        android:inputType="text">

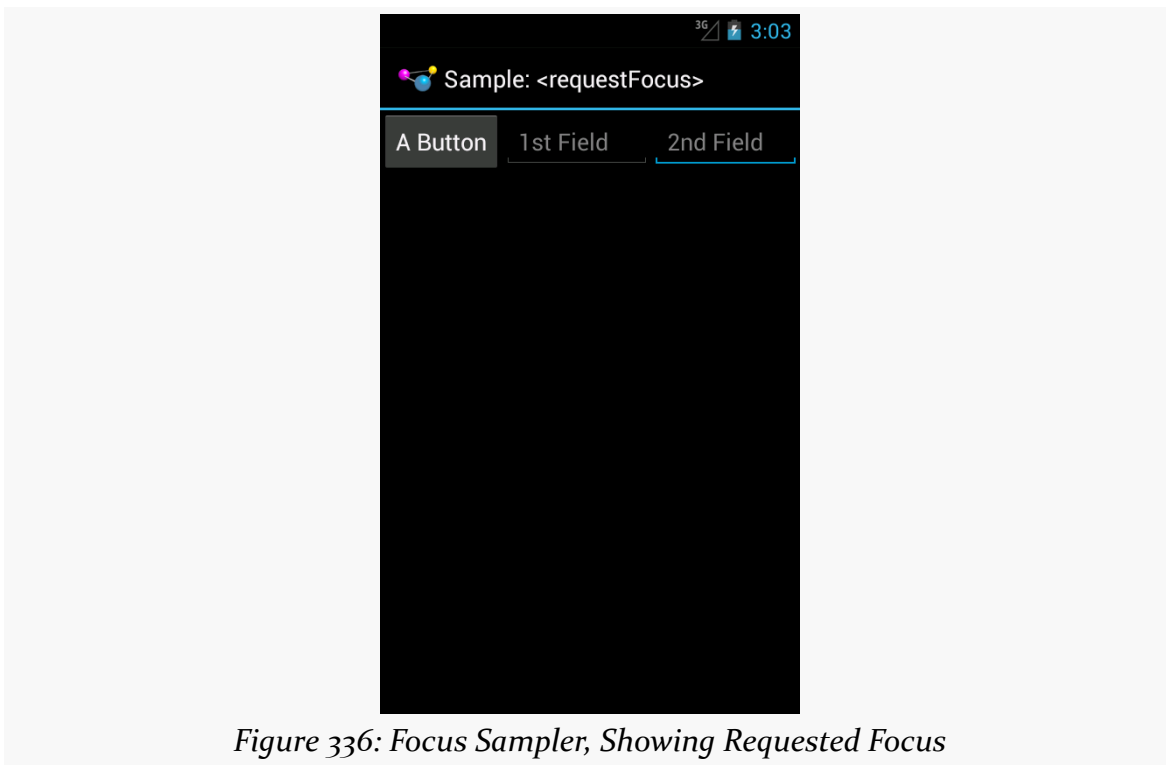
        <requestFocus/>
    </EditText>

</LinearLayout>
```

## FOCUS MANAGEMENT AND ACCESSIBILITY

---

Here, we have three widgets in a horizontal `LinearLayout`: a `Button`, and two `EditText` widgets. The second `EditText` widget has the `<requestFocus />` child element, and so it gets the focus when we display our launcher activity:



*Figure 336: Focus Sampler, Showing Requested Focus*

If we had skipped the `<requestFocus />` element, the focus would have wound up on the first `EditText`... assuming that we are working in touch mode. If the activity had been launched via the pointing device or keyboard, then the `Button` would have the focus, because the `Button` is focusable in non-touch mode by default.

Calling `requestFocus()` from Java code gets a bit trickier. There are a few flavors of the `requestFocus()` method on `View`, of which two will be the most popular:

- An ordinary zero-argument `requestFocus()`
- A one-argument `requestFocus()`, with the argument being the direction in which the focus should theoretically be coming from

You might look at the description of the second flavor and decide that the zero-argument `requestFocus()` looks a lot easier. And, sometimes it will work. However, sometimes it will not, as is the case with our second activity, `RequestFocusActivity`.



In this activity, our layout (focusable\_button) is a bit different:

```
<LinearLayout xmlns:android="http://schemas.android.com/apk/res/android"
    android:layout_width="fill_parent"
    android:layout_height="fill_parent">

    <EditText
        android:id="@+id/editText1"
        android:layout_width="0dp"
        android:layout_height="wrap_content"
        android:layout_weight="1"
        android:contentDescription="@string/first_field"
        android:hint="@string/str_1st_field"
        android:inputType="text"/>

    <EditText
        android:id="@+id/editText2"
        android:layout_width="0dp"
        android:layout_height="wrap_content"
        android:layout_weight="1"
        android:contentDescription="@string/second_field"
        android:hint="@string/str_2nd_field"
        android:inputType="text">
    </EditText>

    <Button
        android:id="@+id/button1"
        android:layout_width="wrap_content"
        android:layout_height="wrap_content"
        android:focusableInTouchMode="true"
        android:text="@string/a_button"/>

</LinearLayout>
```

Here, we put the Button last instead of first. We have no `<requestFocus />` element anywhere, which would put the default focus on the first EditText widget. And, our Button has `android:focusableInTouchMode="true"`, so it will be focusable regardless of whether we are in touch mode or not.

In `onCreate()` of our activity, we use the one-parameter version of `requestFocus()` to give the Button the focus:

```
@Override
public void onCreate(Bundle savedInstanceState) {
    super.onCreate(savedInstanceState);
    setContentView(R.layout.focusable_button);
    initActionBar();

    button=findViewById(R.id.button1);
    button.requestFocus(View.FOCUS_RIGHT);
}
```

## FOCUS MANAGEMENT AND ACCESSIBILITY

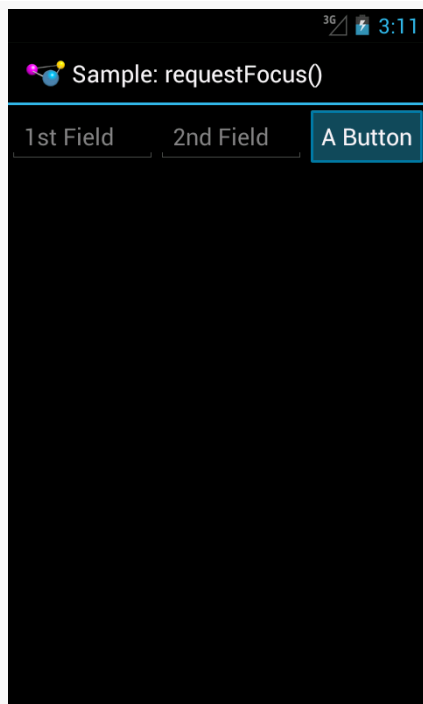
---

```
button.setOnClickListener(this);  
}
```

If there were only the one `EditText` before the `Button`, the zero-argument `requestFocus()` works. However, with two widgets between the default focus and our `Button`, the zero-argument `requestFocus()` does not work, but using `requestFocus(View.FOCUS_RIGHT)` does. This tells Android that we want the focus, and it should be as if the user is moving to the right from where the focus currently lies.

All of our activities inherit from a `BaseActivity` that manages our action bar, with an overflow menu to get to the samples and the home affordance to get to the original activity.

So, if you run the app and choose “Request Focus” from the overflow menu, you will see:

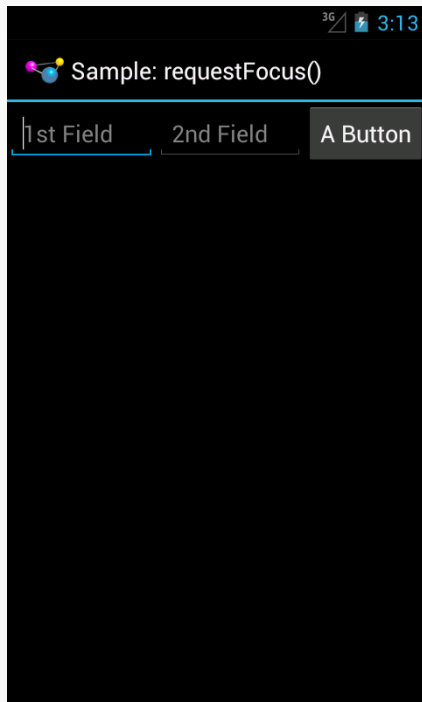


*Figure 337: Focus Sampler, Showing Manually-Requested Focus*

We also wire up the `Button` to the activity for click events, and in `onClick()`, we call `clearFocus()` to abandon the focus:

```
@Override
public void onClick(View v) {
    button.clearFocus();
}
```

What `clearFocus()` will do is return to the original default focus for this activity, in our case the first `EditText`:



*Figure 338: Focus Sampler, After Clearing the Focus*

### Focus Ordering

Beyond manually placing the focus on a widget (or manually clearing that focus), you can also override the focus order that Android determines automatically. While Android's decisions usually are OK, they may not be optimal.

A widget can use `android:nextFocus...` attributes in the layout file to indicate the widget that should get control on a focus change in the direction indicated by the ... part. So, `android:nextFocusDown`, applied to Widget A, indicates which widget should receive the focus if, when the focus is on Widget A, the user “moves down” (e.g., presses a DOWN key, presses the down direction on a D-pad). The same logic holds true for the other three directions (`android:nextFocusLeft`, `android:nextFocusRight`, and `android:nextFocusUp`).

For example, the `res/layout/table.xml` resource in the FocusSampler project is based on the `TableLayout` sample from early in this book, with a bit more focus control:

```
<?xml version="1.0" encoding="utf-8"?>
<TableLayout xmlns:android="http://schemas.android.com/apk/res/android"
    android:layout_width="fill_parent"
    android:layout_height="fill_parent"
    android:stretchColumns="1">

    <TableRow>

        <TextView android:text="@string/url"/>

        <EditText
            android:id="@+id/entry"
            android:layout_span="3"
            android:inputType="text"
            android:nextFocusRight="@+id/ok"/>
    </TableRow>

    <TableRow>

        <Button
            android:id="@+id/cancel"
            android:layout_column="2"
            android:text="@string/cancel"/>

        <Button
            android:id="@+id/ok"
            android:text="@string/ok"/>
    </TableRow>
</TableLayout>
```

In the original `TableLayout` sample, by default, pressing either `RIGHT` or `DOWN` while the `EditText` has the focus will move the focus to the “Cancel” button. This certainly works. However, it does mean that there is no single-key means of moving from the `EditText` to the “OK” button, and it would be nice to offer that, so those using the pointing device or keyboard can quickly move to either button.

This is a matter of overriding the default focus-change behavior of the `EditText` widget. In our case, we use `android:nextFocusRight="@+id/ok"` to indicate that the “OK” button should get the focus if the user presses `RIGHT` from the `EditText`. This gives `RIGHT` and `DOWN` different behavior, to reach both buttons.

## Scrolling and Focusing Do Not Mix

Let's suppose that you have a UI design with a fixed bar of widgets at the top (e.g., action bar), a `ListView` dominating the activity, and a panel of widgets at the bottom (e.g., button panel, or a split action bar), such as this book's original action bar demo:



This is a common UI pattern, much to the detriment of those using pointing devices or keyboards for navigation. In order to get to the bottom panel of widgets, they will have to scroll through the entire list first, because scrolling trumps focus changes. So while this is easy to navigate via a touchscreen, it is a major problem to navigate for those not using a touchscreen.

Similarly, if the user has scrolled down the list, and now wishes to get to the top action bar, the user would have to scroll all the way to the top of the list first.

Workarounds include:

- Overriding focus control such that left and right navigation from the list moves you to the action bar or button panel (e.g., left moves you to the action bar, right moves you to the button panel)
- In a television setup, having the “action bar” be vertical down the left, and the button panel be vertical down the right, so you automatically get the left/right navigation to move between these “zones”
- Eliminating the button panel, moving those items instead to the action bar, or perhaps an [action mode](#) (a.k.a., contextual action bar) if the buttons are only relevant if the user checks one or more items in the list
- Offer a hotkey, separate from navigation, that repositions the focus (e.g., CTRL-A to jump to the action bar), if you believe that users will read your documentation to discover this key combination

In the specific case of a split action bar, Android handles this for you: moving focus to the right from the top action bar moves you to the bottom action bar directly, whereas moving focus down from the top action bar moves you into your main content view (e.g., the `ListView` in the action bar sample image shown above).

## Accessibility and Focus

People suffering from impaired vision, including the blind, have had to rely heavily on proper keyboard navigation for their use of Android apps, at least prior to Android 4.0 and “Explore by Touch”. These users need focus to be sensible, so that they can find their way through your app, with TalkBack supplying prompts for what has the focus. Having widgets that are unreachable in practice will eliminate features from your app for this audience, simply because they cannot get to them.

“Explore by Touch” provides accessibility assistance without reliance upon proper focus. However:

- “Explore by Touch” is new to Android 4.0, and many visually-impaired users will be using older devices, particularly through 2013
- “Explore by Touch” is less reliable than keyboard-based navigation, insofar as users have to remember specific screen locations (and get to them without seeing those locations), rather than simply memorizing certain key combinations
- “Explore by Touch”, by requiring additional taps (e.g., double-tap to tap a Button), may cause some challenges when the UI itself requires additional taps (e.g., a double-tap on a widget to perform an action — is this now a triple-tap in “Explore by Touch” mode?)

- “Explore by Touch” is mostly for the visually impaired, and does not help others that might benefit from key-based navigation (e.g., people with limited motor control)

So, even though “Explore by Touch” will help people use apps that cannot be navigated purely through key events, the better you can support keyboards, the better off your users will be.

## Accessibility Beyond Focus

While getting focus management correct goes a long way towards making your application easier to use, it is not the only thing to consider for making your application truly accessible by all possible users. This section covers a number of other things that you should consider as part of your accessibility initiatives.

### Content Descriptions

For TalkBack to work, it needs to have something useful to read aloud to the user. By default, for most widgets, all it can say is the type of widget that has the focus (e.g., “a checkbox”). That does not help the TalkBack-reliant user very much.

Please consider adding `android:contentDescription` attributes to most of your widgets, pointing to a string resource that briefly describes the widget (e.g., “the Enabled checkbox”). This will be used in place of the basic type of widget by TalkBack.

Classes that inherit from `TextView` will use the text caption of the widget by default, so your `Button` widgets may not need `android:contentDescription` if their captions will make sense to TalkBack users.

However, with an `EditText`, since the text will be what the user types in, the text is not indicative of the widget itself. Android will first use your `android:hint` value, if available, falling back to `android:contentDescription` if `android:hint` is not supplied.

Also, bear in mind that if the widget changes purpose, you need to change your `android:contentDescription` to match. For example, suppose you have a media player app with an `ImageButton` that you toggle between “play” and “pause” modes by changing its image. When you change the image, you also need to change the

`android:contentDescription` as well, lest sighted users think the button will now “pause” while blind users think that the button will now “play”.

### Custom Widgets and Accessibility Events

The engine behind TalkBack is an accessibility service. Android ships with some, like TalkBack, and third parties can create other such services.

Stock Android widgets generate relevant accessibility events to feed data into these accessibility services. That is how `android:contentDescription` gets used, for example — on a focus change, stock Android widgets will announce the widget that just received the focus.

If you are creating custom widgets, you may need to raise your own accessibility events. This is particularly true for custom widgets that draw to the Canvas and process raw touch events (rather than custom widgets that merely aggregate existing widgets).

The Android developer documentation provides [instructions for when and how to supply these sorts of events](#).

### Announcing Events

Sometimes, your app will change something about its visual state in ways that do not get picked up very well by any traditional accessibility events. For example, you might use `GestureDetector` to handle some defined library of gestures and change state in your app. Those state changes may have visual impacts, but `GestureDetector` will not know what those are and therefore cannot supply any sort of accessibility event about them.

To help with this, API Level 16 added `announceForAccessibility()` as a method on `View`. Just pass it a string and that will be sent out as an “announcement” style of `AccessibilityEvent`. Your code leveraging `GestureDetector`, for example, could use this to explain the results of having applied the gesture.

### Font Selection and Size

For users with limited vision, being able to change the font size is a big benefit. Android 4.0 finally allows this, via the Settings app, so users can choose between



small, normal, large, and huge font sizes. Any place where text is rendered and is measured in sp will adapt.

The key, of course, is the sp part.

sp is perhaps the most confusing of the available dimension units in Android. px is obvious, and dp (or dip) is understandable once you recognize the impacts of screen density. Similarly, in, mm, and pt are fairly simple, at least once you remember that pt is 1/72nd of an inch.

If the user has the font scale set to “normal”, sp equates to dp, so a dimension of 30sp and 30dp will be the same size. However, values in dp do not change based on font scale; values in sp will increase or decrease in physical size based upon the user’s changes to the font scale.

We can see how this works in the [Accessibility/FontScale](#) sample project.

In our layout (res/layout/activity\_main.xml), we have six pieces of text: two each (regular and bold) measured at 30px, 30dp, and 30sp:

```
<LinearLayout xmlns:android="http://schemas.android.com/apk/res/android"
  xmlns:tools="http://schemas.android.com/tools"
  android:id="@+id/LinearLayout1"
  android:layout_width="match_parent"
  android:layout_height="match_parent"
  android:orientation="vertical">

  <TextView
    android:layout_width="match_parent"
    android:layout_height="wrap_content"
    android:layout_marginTop="10dp"
    android:text="@string/normal_30px"
    android:textSize="30px"
    tools:context=".MainActivity"/>

  <TextView
    android:layout_width="match_parent"
    android:layout_height="wrap_content"
    android:text="@string/bold_30px"
    android:textSize="30px"
    android:textStyle="bold"
    tools:context=".MainActivity"/>

  <TextView
    android:layout_width="match_parent"
    android:layout_height="wrap_content"
    android:layout_marginTop="10dp"
    android:text="@string/normal_30dp"
```

```
        android:textSize="30dp"
        tools:context=".MainActivity"/>

<TextView
    android:layout_width="match_parent"
    android:layout_height="wrap_content"
    android:text="@string/bold_30dp"
    android:textSize="30dp"
    android:textStyle="bold"
    tools:context=".MainActivity"/>

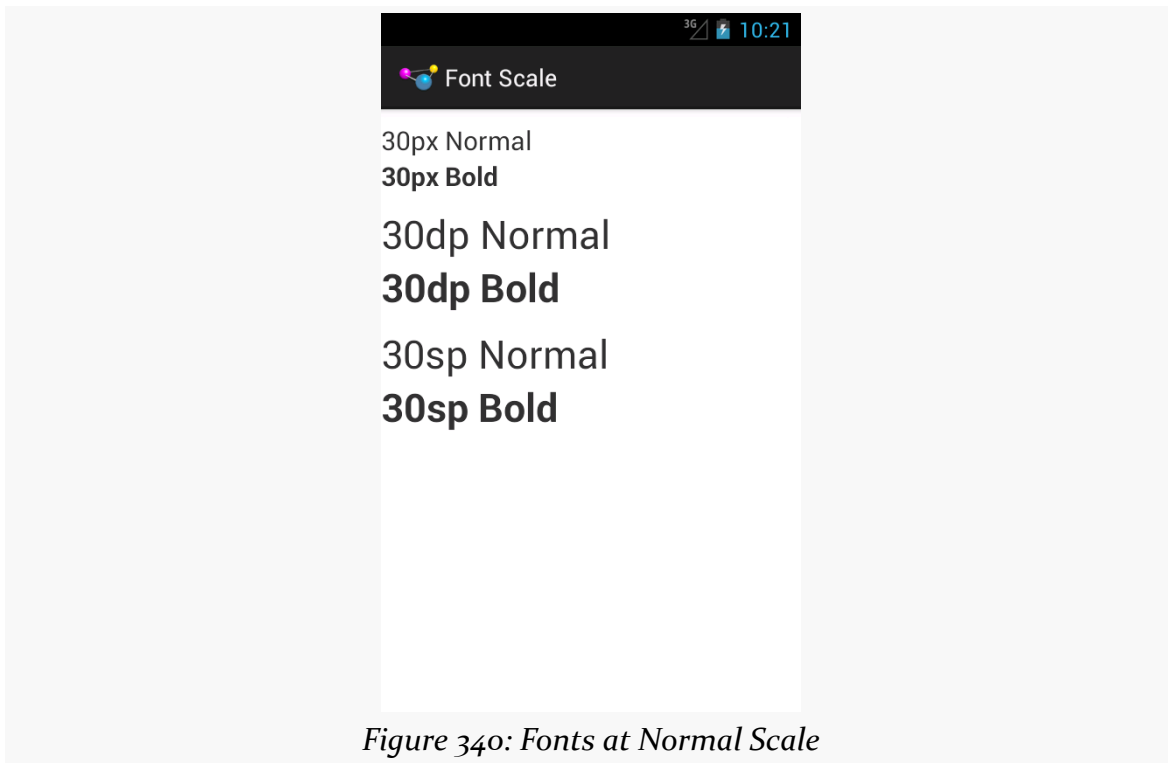
<TextView
    android:layout_width="match_parent"
    android:layout_height="wrap_content"
    android:layout_marginTop="10dp"
    android:text="@string/normal_30sp"
    android:textSize="30sp"
    tools:context=".MainActivity"/>

<TextView
    android:layout_width="match_parent"
    android:layout_height="wrap_content"
    android:text="@string/bold_30sp"
    android:textSize="30sp"
    android:textStyle="bold"
    tools:context=".MainActivity"/>

</LinearLayout>
```

You will be able to see the differences between 30px and 30dp on any Android OS release, simply by running the app on devices with different densities. To see the changes between 30dp and 30sp, you will need to run the app on an Android 4.0+ device or emulator and change the font scale from the Settings app (typically in the Display section).

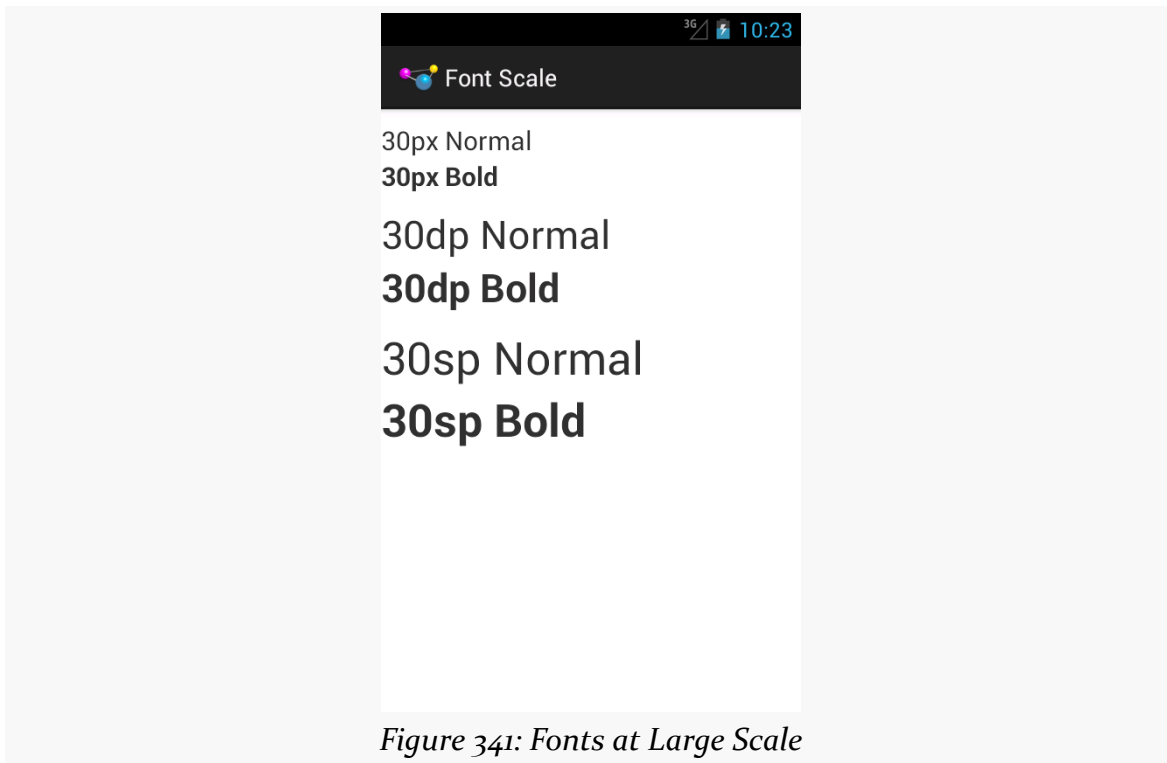
Here is what the text looks like with a normal font scale:



*Figure 340: Fonts at Normal Scale*

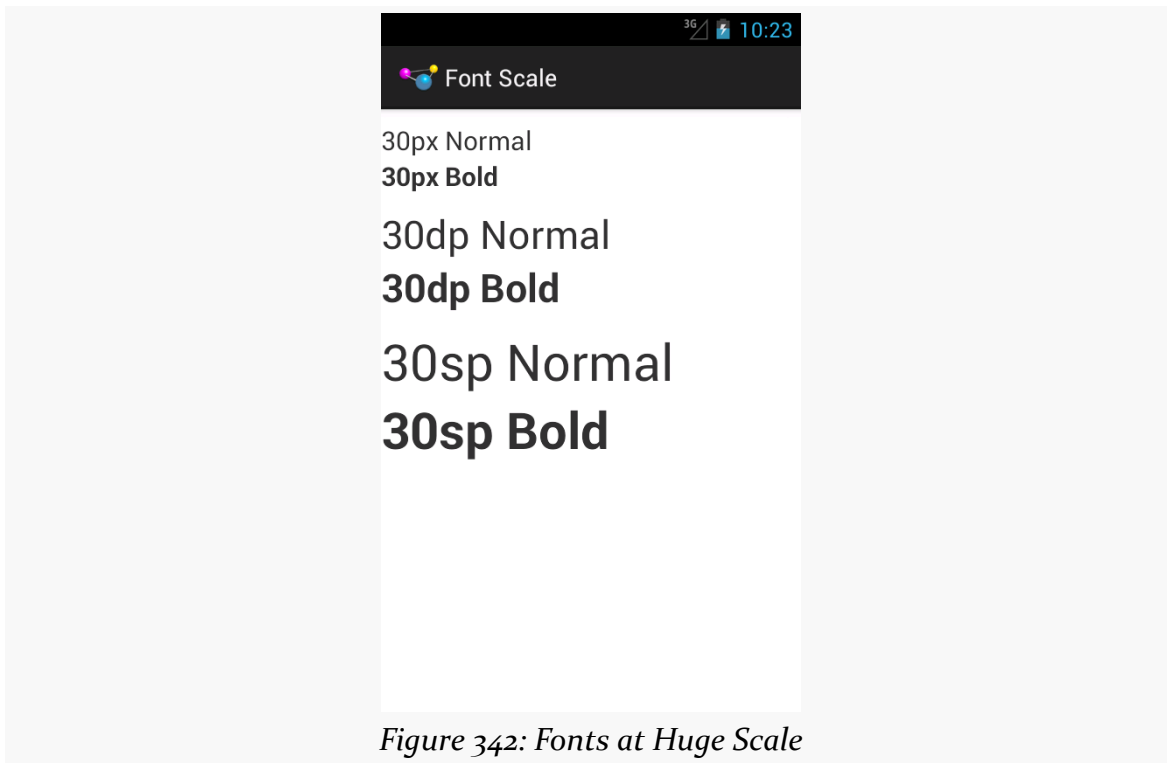
As you can see, 30dp and 30sp are equivalent.

If we raise the font scale to “large”, the 30sp text grows to match:



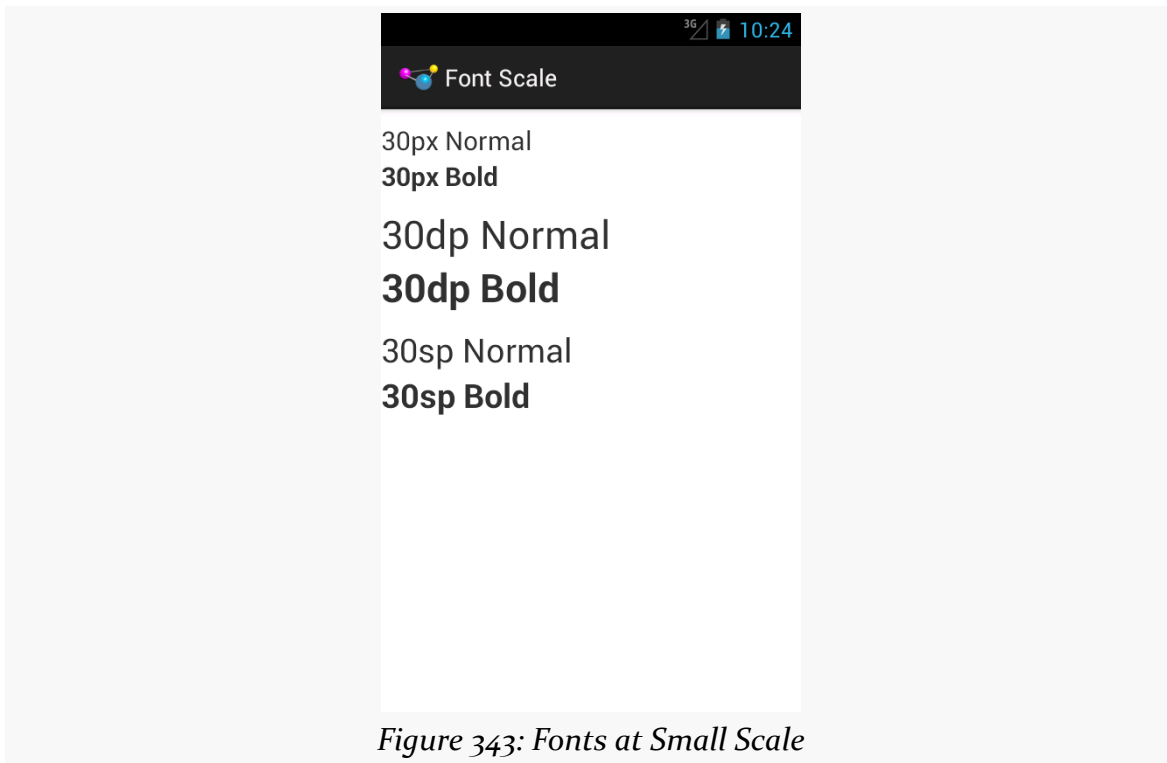
*Figure 341: Fonts at Large Scale*

Moving to “huge” scale increases the 30sp text size further:



*Figure 342: Fonts at Huge Scale*

In the other direction, some users may elect to drop their font size to “small”, with a corresponding impact on the 30sp text:



*Figure 343: Fonts at Small Scale*

As a developer, your initial reaction may be to run away from sp, because you do not control it. However, just as Web developers should deal with changing font scale in Web browsers, Android developers should deal with changing font scale in Android apps. Remember: the user is changing the font scale because the *user* feels that the revised scale is easier for them to use. Blocking such changes in your app, by avoiding sp, will not be met with love and adoration from your user base.

Also, bear in mind that changes to the font scale represent a configuration change. If your app is in memory at the time the user goes into Settings and changes the scale, if the user returns to your app, each activity that comes to the foreground will undergo the configuration change, just as if the user had rotated the screen or put the device into a car dock or something.

### **Widget Size**

Users with ordinary sight already have trouble with tiny widgets, as they are difficult to tap upon.

Users trying to use the Explore by Touch facility added in Android 4.1 have it worse, as they cannot even see (or see well) the tiny target you are expecting them to tap

upon. They need to be able to reliably find your widget based on its relative position on the screen, and their ability to do so will be tied, in part, on widget size.

The [Android design guidelines recommend](#) 7–10mm per side minimum sizes for tappable widgets. In particular, they recommend 48dp per side, which results in a size of about 9mm per side.

You also need to consider how closely packed your widgets are. The closer the tap targets lie, the more likely it is that all users — whether using Explore by Touch or not — will accidentally tap on the wrong thing. Google recommends 8dp or more of margin between widgets. Also note that the key is *margins*, as while increasing padding might visually separate the widgets, the padding is included as part of the widget from the standpoint of touch events. While padding may help users with ordinary sight, margins provide similar help while also being of better benefit to those using Explore by Touch.

### Gestures and Taps

If you employ gestures, be careful when employing the same gesture in different spots for different roles, particularly within the same activity.

For example, you might use a horizontal swipe to the right to switch pages in a `ViewPager` in some places and remove items from a `ListView` in others. While there may be visual cues to help explain this to users with ordinary sight, it may be far less obvious what is going on for TalkBack users. This is even more true if you are somehow combining these things (e.g., the `ListView` in question is in a page of the `ViewPager`).

Also, be a bit careful as you “go outside the box” for tap events. You might decide that a double-tap, or a two-finger tap, has special meaning on some widgets. Make sure that this still works when users use Explore by Touch, considering that the first tap will be “consumed” by Explore by Touch to announce the widget being tapped upon.

### Enhanced Keyboard Support

All else being equal, users seeking accessibility assistance will tend to use keyboards when available. For users with limited (or no) sight, tactile keyboards are simply easier to use than touchscreens. For users with limited motor control, external devices that interface as keyboards may allow them to use devices that otherwise they could not.

Of course, plenty of users will use keyboards outside of accessibility as well. For example, devices like the ASUS Transformer series form perfectly good “netbook”-style devices when paired with their keyboards.

Hence, consider adding hotkey support, to assist in the navigation of your app. Some hotkeys may be automatically handled (e.g., Ctrl-C for copy in an `EditText`). However, in other cases you may wish to add those yourself (e.g., Ctrl-C for “copy” with respect to a checklist and its selected rows, in addition to a “copy” action mode item).

API Level 11 adds `KeyEvent` support for methods like `isCtrlPressed()` to detect meta keys used in combination with regular keys.

### Audio and Haptics

Of course, another way to make your app more accessible is to provide alternative modes of input and output, beyond the visual.

Audio is popular in this regard:

- Using tones or clicks to reinforce input choices
- Integrating your own text-to-speech to augment TalkBack
- Integrating speech recognition for simple commands

However, bear in mind that deaf users will be unable to hear your audio. You are better served using both auditory and visual output, not just one or the other.

In some cases, haptics can be helpful for input feedback, by using the `Vibrator` system service to power the vibration motor. While most users will be able to feel vibrations, the limitation here is whether the device is capable of vibrating:

- Some tablets lack a vibration motor
- Television-based Android environment may or may not have some sort of vibration output (e.g., remote controls probably will not, but game controllers might)
- Devices not held in one’s hand, such as those in a dock, will make haptics less noticeable

So, audio and vibration can help augment visual input and output, though they should not be considered complete replacements except in rare occurrences.



### Color and Color Blindness

[Approximately 8% of men \(and 0.5% of women\)](#) in the world are colorblind, meaning that they cannot distinguish certain close colors:

...It's not that colorblind people (in most cases) are incapable or perceiving "green," instead they merely distinguish fewer shades of green than you do. So where you see three similar shades of green, a colorblind user might only see one shade of green.

(from ["Tips for Designing for Colorblind Users"](#))

Hence, relying solely on colors to distinguish different items, particularly when required for user input, is not a wise move.

Make sure that there is something more to distinguish two pieces of your UI than purely a shift in color, such as:

- Labels or icons
- Textures (e.g., solid vs. striped)
- Borders (e.g., drop shadow)

### Accessibility Beyond Impairment

Accessibility is often tied to impaired users: ones with limited (or no) sight, ones with limited (or no) hearing, ones with limited motor control, etc.

In reality, accessibility is for *situations* where users may have limitations. For example, a user who might not normally think of himself as "impaired" has limited sight, hearing, and motor control when those facilities are already in use, such as while driving.

Hence, offering features that help with accessibility can benefit *all* your users, not just ones you think of as "impaired". For example:

- Offer a UI mode with an eye towards use in low-visibility situations that can either be manually invoked (e.g., via a preference) or automatically invoked (e.g., via a car dock)
- Offer voice input (commands) and output (text-to-speech) — iOS's Siri is not just for the blind, after all

## FOCUS MANAGEMENT AND ACCESSIBILITY

---

- Offer hotkeys, not only to help those requiring a keyboard as their primary mode of input (e.g., blind users minimizing touchscreen use), but to help those who opt into using it for input (e.g., using a keyboard with an Android tablet in lieu of a traditional notebook or netbook)



# Home Screen App Widgets

---

One of the oft-requested features added in Android 1.5 was the ability to add live elements to the home screen. Called “app widgets”, these can be added by users via a long-tap on the home screen and choosing an appropriate widget from the available roster. Android ships with a few app widgets, such as a music player, but developers can add their own — in this chapter, we will see how this is done.

For the purposes of this book, “app widgets” will refer to these items that go on the home screen. Other uses of the term “widget” will be reserved for the UI widgets, subclasses of View, usually found in the `android.widget` Java package.

In this chapter, we briefly touch on the [security](#) ramifications of app widgets, before continuing on to discuss how Android offers a [secure app widget](#) framework. We then go through all the steps of [creating a basic app widget](#). Next, we discuss how to deal with [multiple instances](#) of your app widget, the app widget [lifecycle](#), alternative models for [updating](#) app widgets, and how to offer [multiple layouts](#) for your app widget (perhaps based on device characteristics). We wrap with some notes about [hosting](#) your own app widgets in your own home screen implementation.

## Prerequisites

Understanding this chapter requires that you have read the core chapters, particularly the chapters on:

- [basic widgets](#)
- [broadcast Intents](#)
- [services](#)

### East is East, and West is West...

Part of the reason it took as long as it did for app widgets to become available is security.

Android's security model is based heavily on Linux user, file, and process security. Each application is (normally) associated with a unique user ID. All of its files are owned by that user, and its process(es) run as that user. This prevents one application from modifying the files of another or otherwise injecting their own code into another running process.

In particular, the core Android team wanted to find a way that would allow app widgets to be displayed by the home screen application, yet have their content come from another application. It would be dangerous for the home screen to run arbitrary code itself or somehow allow its UI to be directly manipulated by another process.

The app widget architecture, therefore, is set up to keep the home screen application independent from any code that puts app widgets on that home screen, so bugs in one cannot harm the other.

### The Big Picture for a Small App Widget

The way Android pulls off this bit of security is through the use of `RemoteViews`.

The application component that supplies the UI for an app widget is not an `Activity`, but rather a `BroadcastReceiver` (often in tandem with a `Service`). The `BroadcastReceiver`, in turn, does not inflate a normal `View` hierarchy, like an `Activity` would, but instead inflates a layout into a `RemoteViews` object.

`RemoteViews` encapsulates a limited edition of normal widgets, in such a fashion that the `RemoteViews` can be “easily” transported across process boundaries. You configure the `RemoteViews` via your `BroadcastReceiver` and make those `RemoteViews` available to Android. Android in turn delivers the `RemoteViews` to the app widget host (usually the home screen), which renders them to the screen itself.

This architectural choice has many impacts:

- You do not have access to the full range of widgets and containers. You can use `FrameLayout`, `LinearLayout`, and `RelativeLayout` for containers, and

## HOME SCREEN APP WIDGETS

---

AnalogClock, Button, Chronometer, ImageButton, ImageView, ProgressBar, and TextView for widgets. And, on API Level 11 and higher, you can use some AdapterView-based widgets, like ListView, as we will examine [in the next chapter](#).

- The only user input you can get is clicks of the Button and ImageButton widgets. In particular, there is no EditText for text input.
- Because the app widgets are rendered in another process, you cannot simply register an OnClickListener to get button clicks; rather, you tell RemoteViews a PendingIntent to invoke when a given button is clicked.
- You do not hold onto the RemoteViews and reuse them yourself. Rather, the pattern appears to be that you create and send out a brand-new RemoteViews whenever you want to change the contents of the app widget. This, coupled with having to transport the RemoteViews across process boundaries, means that updating the app widget is rather expensive in terms of CPU time, memory, and battery life.
- Because the component handling the updates is a BroadcastReceiver, you have to be quick (lest you take too long and Android consider you to have timed out), you cannot use background threads, and your component itself is lost once the request has been completed. Hence, if your update might take a while, you will probably want to have the BroadcastReceiver start a Service and have the Service do the long-running task and eventual app widget update.

## Crafting App Widgets

This will become somewhat easier to understand in the context of some sample code. In the [AppWidget/PairOfDice](#) project, you will find an app widget that displays a roll of a pair of dice. Clicking on the app widget re-rolls, in case you want a better result.

### The Manifest

First, we need to register our BroadcastReceiver implementation in our AndroidManifest.xml file, along with a few extra features:

```
<?xml version="1.0" encoding="utf-8"?>
<manifest xmlns:android="http://schemas.android.com/apk/res/android"
    package="com.commonware.android.appwidget.dice"
    android:versionCode="1"
    android:versionName="1.0">

    <uses-sdk
```

## HOME SCREEN APP WIDGETS

---

```
    android:minSdkVersion="7"
    android:targetSdkVersion="11"/>

<supports-screens
    android:largeScreens="true"
    android:normalScreens="true"
    android:smallScreens="false"/>

<application
    android:icon="@drawable/ic_launcher"
    android:label="@string/app_name">
    <receiver
        android:name=".AppWidget"
        android:icon="@drawable/cw"
        android:label="@string/app_name">
        <intent-filter>
            <action android:name="android.appwidget.action.APPWIDGET_UPDATE"/>
        </intent-filter>

        <meta-data
            android:name="android.appwidget.provider"
            android:resource="@xml/widget_provider"/>
        </receiver>

    <activity
        android:name="PairOfDiceActivity"
        android:theme="@android:style/Theme.NoDisplay">
        <intent-filter>
            <action android:name="android.intent.action.MAIN"/>

            <category android:name="android.intent.category.LAUNCHER"/>
        </intent-filter>
    </activity>
</application>
</manifest>
```

Here, along with a do-nothing activity, we have a <receiver>. Of note:

1. Our <receiver> has `android:label` and `android:icon` attributes, which are not normally needed on `BroadcastReceiver` declarations. However, in this case, those are used for the entry that goes in the menu of available widgets to add to the home screen. Hence, you will probably want to supply values for both of those, and use appropriate resources in case you want translations for other languages.
2. Our <receiver> has an <intent-filter> for the `android.appwidget.action.APPWIDGET_UPDATE` action. This means we will get control whenever Android wants us to update the content of our app widget. There may be other actions we want to monitor — more on this in a [later section](#).

3. Our `<receiver>` also has a `<meta-data>` element, indicating that its `android.appwidget.provider` details can be found in the `res/xml/widget_provider.xml` file. This metadata is described in the next section.

### The Metadata

Next, we need to define the app widget provider metadata. This has to reside at the location indicated in the manifest — in this case, in `res/xml/widget_provider.xml`:

```
<appwidget-provider xmlns:android="http://schemas.android.com/apk/res/android"
    android:minWidth="144dip"
    android:minHeight="72dip"
    android:updatePeriodMillis="900000"
    android:initialLayout="@layout/widget"
/>
```

Here, we provide four pieces of information:

1. The minimum width and height of the app widget (`android:minWidth` and `android:minHeight`). These are approximate — the app widget host (e.g., home screen) will tend to convert these values into “cells” based upon the overall layout of the UI where the app widgets will reside. However, they should be no smaller than the minimums cited here. Also, ideally, you use `dip` instead of `px` for the dimensions, so the number of cells will remain constant regardless of screen density.
2. The frequency in which Android should request an update of the widget’s contents (`android:updatePeriodMillis`). This is expressed in terms of milliseconds, so a value of `3600000` is a 60-minute update cycle. Note that the minimum value for this attribute is 30 minutes — values less than that will be “rounded up” to 30 minutes. Hence our 15-minute (`900000` millisecond) request will actually result in an update every 30 minutes.
3. The initial layout to use for the app widget, for the time between when the user requests the app widget and when `onUpdate()` of our `AppWidgetProvider` gets control.

Note that the calculations for determining the number of cells for an app widget varies. The `dip` dimension value for an  $N$ -cell dimension was  $(74 * N) - 2$  (e.g., a  $2 \times 3$  cell app widget would request a width of `146dip` and a height of `220dip`). The value as of API Level 14 (a.k.a., Ice Cream Sandwich) is now  $(70 * N) - 30$  (e.g., a  $2 \times 3$  cell app widget would request a width of `110dip` and a height of `180dip`). To have your app widgets maintain a consistent number of cells, you will need two versions of



your app widget metadata XML, one in `res/xml-v14/` (with the API Level 14 calculation) and one in `res/xml/` (for prior versions of Android).

### The Layout

Eventually, you are going to need a layout that describes what the app widget looks like. So long as you stick to the widget and container classes noted above, this layout can otherwise look like any other layout in your project.

For example, here is the layout for the `PairOfDice` app widget:

```
<?xml version="1.0" encoding="utf-8"?>
<RelativeLayout xmlns:android="http://schemas.android.com/apk/res/android"
    android:id="@+id/background"
    android:orientation="horizontal"
    android:layout_width="match_parent"
    android:layout_height="match_parent"
    android:background="@drawable/widget_frame"
    >
    <ImageView android:id="@+id/left_die"
        android:layout_centerVertical="true"
        android:layout_alignParentLeft="true"
        android:src="@drawable/die_5"
        android:layout_width="wrap_content"
        android:layout_height="wrap_content"
        android:layout_marginLeft="7dip"
    />
    <ImageView android:id="@+id/right_die"
        android:layout_centerVertical="true"
        android:layout_alignParentRight="true"
        android:src="@drawable/die_2"
        android:layout_width="wrap_content"
        android:layout_height="wrap_content"
        android:layout_marginRight="7dip"
    />
</RelativeLayout>
```

All we have is a pair of `ImageView` widgets (one for each die), inside of a `RelativeLayout`. The `RelativeLayout` has a background, specified as a [nine-patch PNG file](#). This allows the `RelativeLayout` to have guaranteed contrast with whatever wallpaper is behind it, so the user can tell the actual app widget bounds.

### The BroadcastReceiver

Next, we need a `BroadcastReceiver` that can get control when Android wants us to update our `RemoteViews` for our app widget. To simplify this, Android supplies an `AppWidgetProvider` class we can extend, instead of the normal `BroadcastReceiver`.

## HOME SCREEN APP WIDGETS

---

This simply looks at the received Intent and calls out to an appropriate lifecycle method based on the requested action.

The one method that invariably needs to be implemented on the provider is `onUpdate()`. Other lifecycle methods may be of interest and are discussed [later](#) in this chapter.

For example, here is the implementation of the `AppWidgetProvider` for `PairOfDice`:

```
package com.commonware.android.appwidget.dice;

import android.app.PendingIntent;
import android.appwidget.AppWidgetManager;
import android.appwidget.AppWidgetProvider;
import android.content.ComponentName;
import android.content.Context;
import android.content.Intent;
import android.widget.RemoteViews;

public class AppWidget extends AppWidgetProvider {
    private static final int[] IMAGES={R.drawable.die_1,R.drawable.die_2,
                                        R.drawable.die_3,R.drawable.die_4,
                                        R.drawable.die_5,R.drawable.die_6};

    @Override
    public void onUpdate(Context ctxt, AppWidgetManager mgr,
                        int[] appWidgetIds) {
        ComponentName me=new ComponentName(ctxt, AppWidget.class);

        mgr.updateAppWidget(me, buildUpdate(ctxt, appWidgetIds));
    }

    private RemoteViews buildUpdate(Context ctxt, int[] appWidgetIds) {
        RemoteViews updateViews=new RemoteViews(ctxt.getPackageName(),
                                                R.layout.widget);

        Intent i=new Intent(ctxt, AppWidget.class);

        i.setAction(AppWidgetManager.ACTION_APPWIDGET_UPDATE);
        i.putExtra(AppWidgetManager.EXTRA_APPWIDGET_IDS, appWidgetIds);

        PendingIntent pi=PendingIntent.getBroadcast(ctxt, 0 , i,
PendingIntent.FLAG_UPDATE_CURRENT);

        updateViews.setImageViewResource(R.id.left_die,
                                        IMAGES[(int)(Math.random()*6)]);
        updateViews.setOnClickPendingIntent(R.id.left_die, pi);
        updateViews.setImageViewResource(R.id.right_die,
                                        IMAGES[(int)(Math.random()*6)]);
        updateViews.setOnClickPendingIntent(R.id.right_die, pi);
    }
}
```

## HOME SCREEN APP WIDGETS

---

```
updateViews.setOnClickPendingIntent(R.id.background, pi);  
return(updateViews);  
}  
}
```

To update the RemoteViews for our app widget, we need to build those RemoteViews (delegated to a `buildUpdate()` helper method) and tell an `AppWidgetManager` to update the widget via `updateAppWidget()`. In this case, we use a version of `updateAppWidget()` that takes a `ComponentName` as the identifier of the widget to be updated. Note that this means that we will update all instances of this app widget presently in use — the concept of multiple app widget instances is covered in greater detail [later](#) in this chapter.

Working with RemoteViews is a bit like trying to tie your shoes while wearing mittens — it may be possible, but it is a bit clumsy. In this case, rather than using methods like `findViewById()` and then calling methods on individual widgets, we need to call methods on RemoteViews itself, providing the identifier of the widget we wish to modify. This is so our requests for changes can be serialized for transport to the home screen process. It does, however, mean that our view-updating code looks a fair bit different than it would if this were the main View of an activity or row of a `ListView`.

To create the RemoteViews, we use a constructor that takes our package name and the identifier of our layout. This gives us a RemoteViews that contains all of the widgets we declared in that layout, just as if we inflated the layout using a `LayoutInflater`. The difference, of course, is that we have a RemoteViews object, not a View, as the result.

We then use methods like:

1. `setImageResource()` to set the image for each of our `ImageView` widgets, in this case a randomly chosen die face (using graphics created from a set of SVG files from the [OpenClipArt site](#))
2. `setOnClickListener()` to provide a `PendingIntent` that should get fired off when a die, or the overall app widget background, is clicked

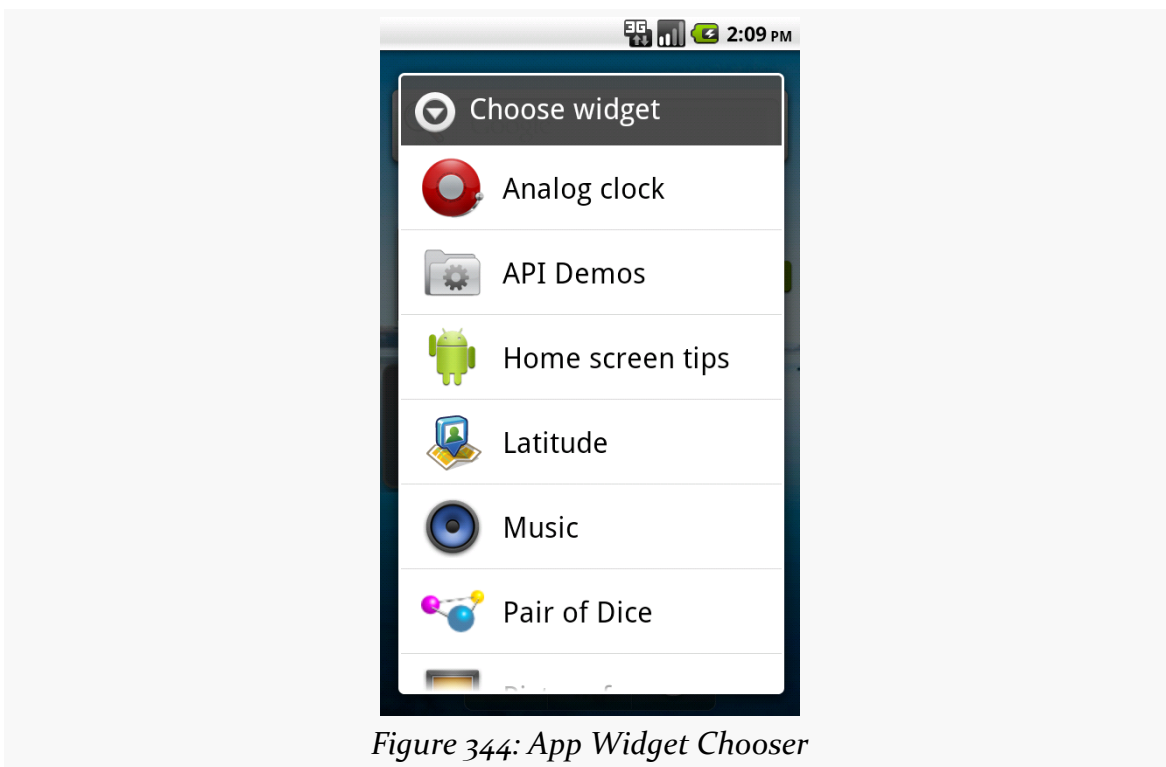
We then supply that RemoteViews to the `AppWidgetManager`, which pushes the RemoteViews structure to the home screen, which renders our new app widget UI.

### The Result

If you compile and install all of this, you will have a new widget entry available. How you add app widgets to the home screen varies based upon Android version (and, in some cases, the home screen implementation).

### Stock Android 1.x/2.x

When you long-tap on the home screen background, you will get a list of available app widgets to install:

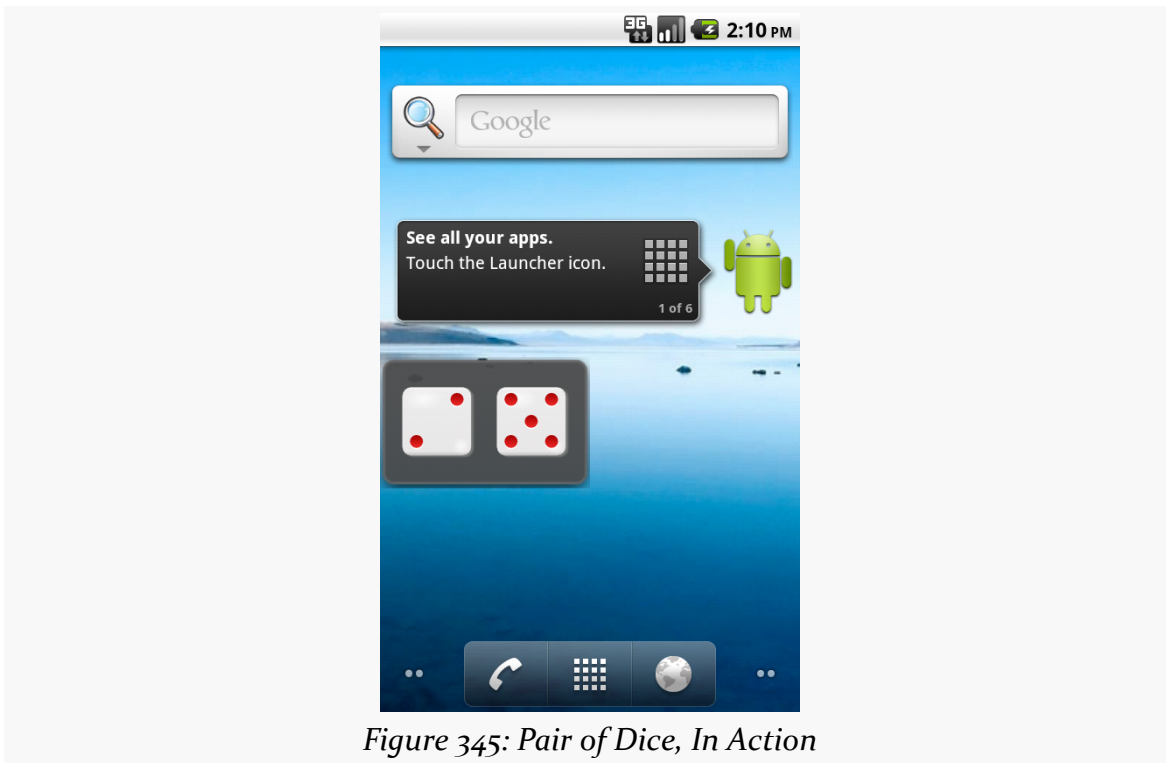


*Figure 344: App Widget Chooser*

When you choose Pair of Dice, the app widget will appear on the home screen:

## HOME SCREEN APP WIDGETS

---



*Figure 345: Pair of Dice, In Action*

To re-roll, just tap anywhere on the app widget.

### **Stock Android 3.0+**

Your launcher will contain separate sections for “apps” (launcher activities) and “widgets” (app widgets):

## HOME SCREEN APP WIDGETS

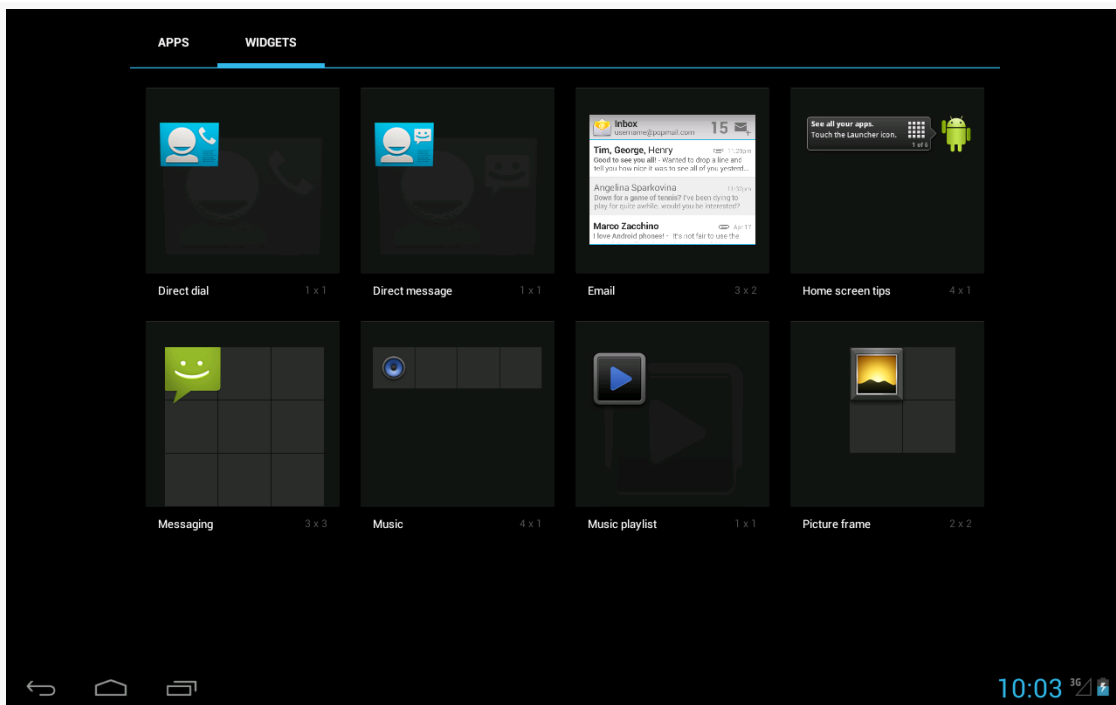


Figure 346: Widgets Section of Launcher

Long-tap on the app widget you want, and the launcher will vanish, allowing you to drag and drop the app widget onto your home screen.

## Another and Another

As indicated above, you can have multiple instances of the same app widget outstanding at any one time. For example, one might have multiple picture frames, or multiple “show-me-the-latest-RSS-entry” app widgets, one per feed. You will distinguish between these in your code via the identifier supplied in the relevant `AppWidgetProvider` callbacks (e.g., `onUpdate()`).

If you want to support separate app widget instances, you will need to store your state on a per-app-widget-identifier basis. You will also need to use an appropriate version of `updateAppWidget()` on `AppWidgetManager` when you update the app widgets, one that takes app widget identifiers as the first parameter, so you update the proper app widget instances.

Conversely, there is nothing requiring you to support multiple instances as independent entities. For example, if you add more than one `PairOfDice` app widget

to your home screen, nothing blows up – they just show the same roll. That is because `PairOfDice` uses a version of `updateAppWidget()` that does not take any app widget IDs, and therefore updates all app widgets simultaneously.

## App Widgets: Their Life and Times

There are three other lifecycle methods that `AppWidgetProvider` offers that you may be interested in:

1. `onEnabled()` will be called when the first widget instance is created for this particular widget provider, so if there is anything you need to do once for all supported widgets, you can implement that logic here
2. `onDeleted()` will be called when a widget instance is removed from the home screen, in case there is any data you need to clean up specific to that instance
3. `onDisabled()` will be called when the last widget instance for this provider is removed from the home screen, so you can clean up anything related to all such widgets

Note, however, that there is a bug in Android 1.5, where `onDeleted()` will not be properly called. You will need to implement `onReceive()` and watch for the `ACTION_APPWIDGET_DELETED` action in the received `Intent` and call `onDeleted()` yourself. This has since been fixed, and if you are not supporting Android 1.5, you will not need to worry about this problem.

## Controlling Your (App Widget's) Destiny

As `PairOfDice` illustrates, you are not limited to updating your app widget only based on the timetable specified in your metadata. That timetable is useful if you can get by with a fixed schedule. However, there are cases in which that will not work very well:

1. If you want the user to be able to configure the polling period (the metadata is baked into your APK and therefore cannot be modified at runtime)
2. If you want the app widget to be updated based on external factors, such as a change in location

The recipe shown in `PairOfDice` will let you use `AlarmManager` (described in [another chapter](#)) or proximity alerts or whatever to trigger updates. All you need to do is:

## HOME SCREEN APP WIDGETS

---

1. Arrange for something to broadcast an Intent that will be picked up by the BroadcastReceiver you are using for your app widget provider
2. Have the provider process that Intent directly or pass it along to a Service (such as an IntentService)

Also, note that the `updatePeriodMillis` setting not only tells the app widget to update every so often, it will even *wake up the phone* if it is asleep so the widget can perform its update. On the plus side, this means you can easily keep your widgets up to date regardless of the state of the device. On the minus side, this will tend to drain the battery, particularly if the period is too fast. If you want to avoid this wakeup behavior, set `updatePeriodMillis` to 0 and use `AlarmManager` to control the timing and behavior of your widget updates.

Note that if there are multiple instances of your app widget on the user's home screen, they will all update approximately simultaneously if you are using `updatePeriodMillis`. If you elect to set up your own update schedule, you can control which app widgets get updated when, if you choose.

## Change Your Look

If you have been doing most of your development via the Android emulator, you are used to all “devices” having a common look and feel, in terms of the home screen, lock screen, and so forth. This is the so-called “Google Experience” look, and many actual Android devices have it.

However, some devices have their own presentation layers. HTC has “Sense”, seen on the HTC Hero and HTC Tattoo, among other devices. Motorola has MOTOBLUR, seen on the Motorola CLIQ and DEXT. Other device manufacturers, like Sony Ericsson, Samsung, and LG, have followed suit, as will others in the future. These presentation layers replace the home screen and lock screen, among other things. Moreover, they usually come with their own suite of app widgets with their own look and feel. Your app widget may look fine on a Google Experience home screen, but the look might clash when viewed on a Sense or MOTOBLUR device.

Fortunately, there are ways around this. You can set your app widget's look on the fly at runtime, to choose the layout that will look the best on that particular device.

The first step is to create an app widget layout that is initially invisible (`res/layout/invisible.xml`):



---

## HOME SCREEN APP WIDGETS

---

```
<?xml version="1.0" encoding="utf-8"?>
<RelativeLayout xmlns:android="http://schemas.android.com/apk/res/android"
    android:orientation="horizontal"
    android:layout_width="match_parent"
    android:layout_height="match_parent"
    android:visibility="invisible"
    >
</RelativeLayout>
```

This layout is then the one you would reference from your app widget metadata, to be used when the app widget is first created:

```
<appwidget-provider
xmlns:android="http://schemas.android.com/apk/res/android"
    android:minWidth="292dip"
    android:minHeight="72dip"
    android:updatePeriodMillis="900000"
    android:configure="com.commonware.android.appwidget.TWPrefs"
    android:initialLayout="@layout/invisible"
/>
```

This ensures that when your app widget is initially added, you do not get the “Problem loading widget” placeholder, yet you also do not choose one layout versus another — it is simply invisible for a brief moment.

Then, in your `AppWidgetProvider` (or attached `IntentService`), you can make the choice of what layout to inflate as part of your `RemoteViews`. Rather than using the invisible one, you can choose one based on the device or other characteristics. The biggest challenge is that there is no good way to determine what presentation layer, if any, is in use on a device. For the time being, you will need to use the various fields in the `android.os.Build` class to “sniff” on the device model and make a decision that way.

## One Size May Not Fit All

It may be that you want to offer multiple app widget sizes to your users. Some might only want a small app widget. Some might really like what you have to offer and want to give you more home screen space to work in.

The good news: this is easy to do.

The bad news: it requires you, in effect, to have one app widget per size.

## HOME SCREEN APP WIDGETS

---

The size of an app widget is determined by the app widget metadata XML file. That XML file is tied to a `<receiver>` element in the manifest representing one app widget. Hence, to have multiple sizes, you need multiple metadata files and multiple `<receiver>` elements.

This also means your app widgets will show up multiple times in the app widget selection list, when the user goes to add an app widget to their home screen. Hence, supporting many sizes will become annoying to the user, if they perceive you are “spamming” the app widget list. Try to keep the number of app widget sizes to a reasonable number (say, one or two sizes).

As of API Level 11, it is possible to have a resizable app widget. To do this, you can have an `android:resizeMode` attribute in your widget metadata, with a value of `horizontal`, `vertical`, or `both` (e.g., `horizontal|vertical`). When the user long-taps on an existing widget, they should see handles to allow the widget to be resized:



*Figure 347: API Demos App Widget, Resizing*

You can also have `android:minResizeWidth` and `android:minResizeHeight` attributes, measured in dp, that indicate the approximate smallest size that your app widget can support. These values will be interpreted in terms of “cells”, as with the

## HOME SCREEN APP WIDGETS

---

`android:minWidth` and `android:minHeight` attributes, and so the dp values you supply will not be used precisely.

However, for Android 3.x and 4.0 (API Level 11–15), your code would not be informed about being resized. You had to simply ensure that your layout would intelligently use any extra space automatically. Hence, resizing tended to be used primarily with adapter-driven app widgets, as will be discussed [in the next chapter](#).

Starting with API Level 16, though, you can find out when the user resizes your app widget, so you can perhaps use a different layout for a different size, or otherwise adapt to the available space. Finding out about resize events takes a bit more work, as is illustrated in the [AppWidget/Resize](#) sample project.

This app widget project is similar to `PairOfDice`, described earlier in this chapter. However, our layout skips the dice, replacing them with a `TextView` widget in the `RelativeLayout`:

```
<?xml version="1.0" encoding="utf-8"?>
<RelativeLayout xmlns:android="http://schemas.android.com/apk/res/android"
    android:id="@+id/background"
    android:layout_width="match_parent"
    android:layout_height="match_parent"
    android:background="@drawable/widget_frame"
    android:orientation="horizontal">

    <TextView
        android:id="@+id/size"
        android:layout_width="wrap_content"
        android:layout_height="wrap_content"
        android:layout_centerInParent="true"
        android:textAppearance="?android:attr/textAppearanceMedium">

    </TextView>

</RelativeLayout>
```

Our `widget_provider.xml` resource stipulates our desired `android:resizeMode` and minimum resize dimensions:

```
<appwidget-provider xmlns:android="http://schemas.android.com/apk/res/android"
    android:minWidth="180dip"
    android:minHeight="110dip"
    android:minResizeWidth="110dip"
    android:minResizeHeight="40dip"
    android:initialLayout="@layout/widget"
    android:resizeMode="horizontal|vertical"
/>
```

---

## HOME SCREEN APP WIDGETS

---

Finding out about app widget resizing is a different event than finding out about app widget updates. Hence, we need to add a new `<action>` element to the `<intent-filter>` of our `<receiver>` in the manifest, indicating that we want `APPWIDGET_OPTIONS_CHANGED` as well as `ACTION_UPDATE`:

```
<receiver
  android:name="AppWidget"
  android:icon="@drawable/ic_launcher"
  android:label="@string/app_name">
  <intent-filter>
    <action android:name="android.appwidget.action.APPWIDGET_UPDATE" />
    <action
android:name="android.appwidget.action.APPWIDGET_OPTIONS_CHANGED" />
  </intent-filter>

  <meta-data
    android:name="android.appwidget.provider"
    android:resource="@xml/widget_provider" />
</receiver>
```

Then, our app widget implementation can override an `onAppWidgetOptionsChanged()` method:

```
package com.commonware.android.appwidget.resize;

import android.appwidget.AppWidgetManager;
import android.appwidget.AppWidgetProvider;
import android.content.Context;
import android.os.Bundle;
import android.widget.RemoteViews;
import java.util.Locale;

public class AppWidget extends AppWidgetProvider {
    @Override
    public void onAppWidgetOptionsChanged(Context ctxt,
        AppWidgetManager mgr,
        int appWidgetId,
        Bundle newOptions) {

        RemoteViews updateViews=
            new RemoteViews(ctxt.getPackageName(), R.layout.widget);
        String msg=
            String.format(Locale.getDefault(),
                "[%d-%d] x [%d-%d]",

newOptions.getInt(AppWidgetManager.OPTION_APPWIDGET_MIN_WIDTH),
newOptions.getInt(AppWidgetManager.OPTION_APPWIDGET_MAX_WIDTH),
newOptions.getInt(AppWidgetManager.OPTION_APPWIDGET_MIN_HEIGHT),
newOptions.getInt(AppWidgetManager.OPTION_APPWIDGET_MAX_HEIGHT));
```

## HOME SCREEN APP WIDGETS

---

```
updateViews.setTextViewText(R.id.size, msg);  
mgr.updateAppWidget(appWidgetId, updateViews);  
}  
}
```

You will notice that we skip `onUpdate()`. We will be called with `onAppWidgetOptionsChanged()` when the app widget is added and resized. Hence, in the case of this app widget, we can define what the app widget looks like from `onAppWidgetOptionsChanged()`, eschewing `onUpdate()`. That being said, more typical app widgets will wind up implementing both methods, especially if they are supporting lower API levels than 16, where `onAppWidgetOptionsChanged()` will not be called.

Also remember that your process may well be terminated in between calls to app widget lifecycle methods like `onUpdate()` and `onAppWidgetOptionsChanged()`. Hence, if there is data from one method that you want in the other, be sure to persist that data somewhere.

In the `AppWidget` implementation of `onAppWidgetOptionsChanged()`, we can find out about our new app widget size by means of the `Bundle` supplied to our method. What we *cannot* find out is our exact size. Rather, we are provided minimum and maximum dimensions of our app widget via four values in the `Bundle`:

- `AppWidgetManager.OPTION_APPWIDGET_MIN_WIDTH`
- `AppWidgetManager.OPTION_APPWIDGET_MAX_WIDTH`
- `AppWidgetManager.OPTION_APPWIDGET_MIN_HEIGHT`
- `AppWidgetManager.OPTION_APPWIDGET_MAX_HEIGHT`

In our case, we grab these `int` values and pour them into a `String` template, using that to fill in the `TextView` of the app widget's contents.

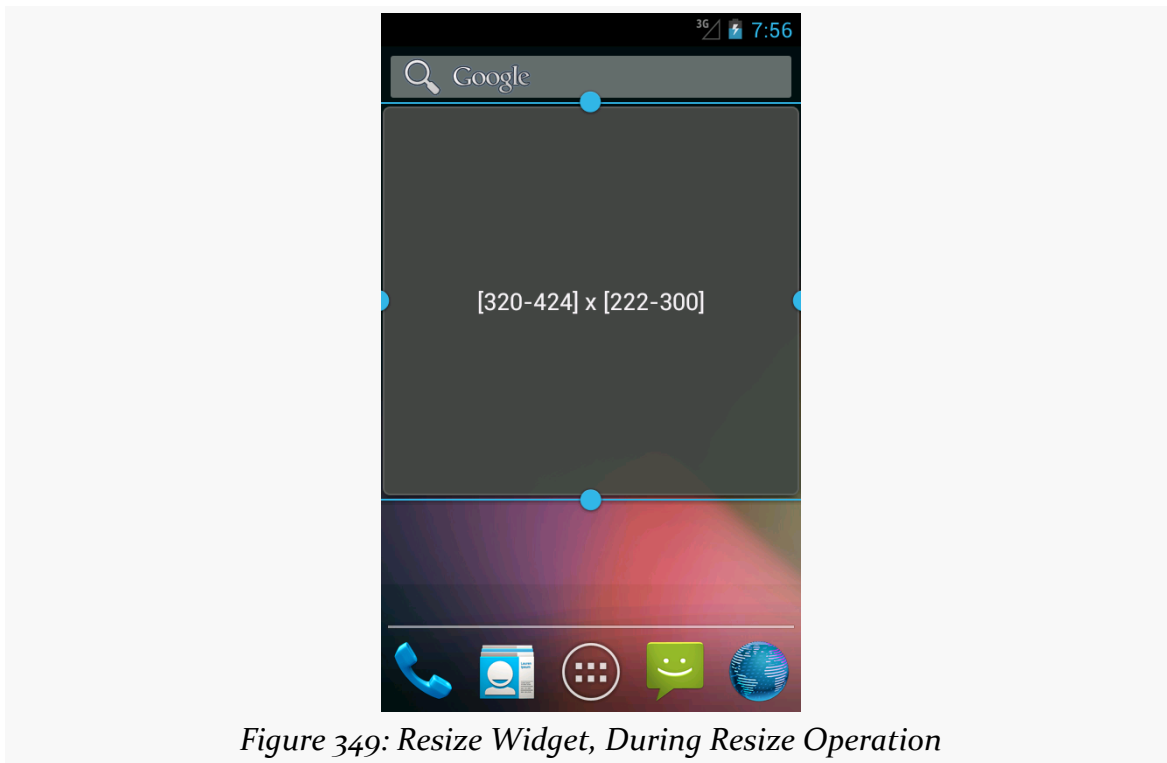
When our app widget is initially launched, we show our initial size ranges:

## HOME SCREEN APP WIDGETS

---



When the user resizes our app widget, we show the new size ranges:



## Lockscreen Widgets

Android's lockscreen (a.k.a., the keyguard) has long been unmodifiable by developers. This led to a number of developers creating so-called “replacement lockscreens”, which generally reduce device security, as they can be readily bypassed. However, with API Level 17 (Android 4.2), developers now can create app widgets that the user can deploy to the lockscreen, helping to eliminate the need for “replacement lockscreens”.

Declaring that an app widget supports being on the lockscreen instead of (or in addition to) the home screen is very easy. All you must do is add an `android:widgetCategory` attribute to your app widget metadata resource. That attribute should have a value of either `keyguard` (for the lockscreen), `home_screen`, or both (e.g., `keyguard|lock_screen`), depending upon where you want the app widget to be eligible. By default, if this attribute is missing, Android assumes a default value of `home_screen`.

Users cannot resize the lockscreen widgets at this time. However, you still will want to specify an `android:resizeMode` attribute in your app widget metadata, as whether

---

## HOME SCREEN APP WIDGETS

---

or not you include vertical resizing will affect the height of your app widget. Lockscreen widgets without vertical will have a fixed small height on tablets, while lockscreen widgets with vertical will fill the available height. Lockscreen widgets on phones will always be small (to fit above the PIN/password entry area), and lockscreen widgets on all devices will stretch to fill available space horizontally.

You can also specify a different starting layout to use when your app is added to the lockscreen, as opposed to being added to the home screen. To do this, just add an `android:initialKeyguardLayout` attribute to your app widget metadata, pointing to the lockscreen-specific layout to use.

To see this in action, take a look at the [AppWidget/TwoOrThreeDice](#) sample project. This is a revised clone of the `PairOfDice` sample, allowing the dice to be added to the lockscreen, and showing three dice on the lockscreen instead of the two on the home screen.

Our app widget metadata now contains the lockscreen-related attributes: `android:widgetCategory` and `android:initialKeyguardLayout`:

```
<appwidget-provider xmlns:android="http://schemas.android.com/apk/res/android"
    android:minWidth="144dip"
    android:minHeight="72dip"
    android:updatePeriodMillis="900000"
    android:initialLayout="@layout/widget"
    android:initialKeyguardLayout="@layout/lockscreen"
    android:widgetCategory="keyguard|home_screen"
/>
```

Our lockscreen layout simply adds a third die, `middle_die`:

```
<?xml version="1.0" encoding="utf-8"?>
<RelativeLayout xmlns:android="http://schemas.android.com/apk/res/android"
    android:id="@+id/background"
    android:orientation="horizontal"
    android:layout_width="match_parent"
    android:layout_height="match_parent"
    android:background="@drawable/widget_frame"
    >
    <ImageView android:id="@+id/left_die"
        android:layout_centerVertical="true"
        android:layout_alignParentLeft="true"
        android:src="@drawable/die_3"
        android:layout_width="wrap_content"
        android:layout_height="wrap_content"
        android:layout_marginLeft="7dip"
    />
    <ImageView android:id="@+id/middle_die"
```



## HOME SCREEN APP WIDGETS

---

```
        android:layout_centerInParent="true"
        android:src="@drawable/die_2"
        android:layout_width="wrap_content"
        android:layout_height="wrap_content"
        android:layout_marginLeft="7dip"
        android:layout_marginRight="7dip"
    />
    <ImageView android:id="@+id/right_die"
        android:layout_centerVertical="true"
        android:layout_alignParentRight="true"
        android:src="@drawable/die_2"
        android:layout_width="wrap_content"
        android:layout_height="wrap_content"
        android:layout_marginRight="7dip"
    />
</RelativeLayout>
```

However, by specifying a different layout for the lockscreen widget, we have a problem. We need to know, in our Java code, what layout to use for the RemoteViews and how many dice need to be updated. And, ideally, we would handle this in a backwards-compatible fashion, so our app widget will have its original functionality on older Android devices. Plus, supporting the lockscreen makes it that much more likely that the user will have more than one instance of our app widget (e.g., one on the lockscreen and one on the homescreen), so we should do a better job than `PairOfDice` did about handling multiple app widget instances.

To deal with the latter point, our new `onUpdate()` method iterates over each of the app widget IDs supplied to it and calls a private `updateWidget()` method for each, so we can better support multiple instances:

```
@Override
public void onUpdate(Context ctxt, AppWidgetManager mgr,
    int[] appWidgetIds) {
    for (int appWidgetId : appWidgetIds) {
        updateWidget(ctxt, mgr, appWidgetId);
    }
}
```

The `updateWidget()` method is a bit more complicated than the `PairOfDice` equivalent code:

```
@TargetApi(Build.VERSION_CODES.JELLY_BEAN_MR1)
private void updateWidget(Context ctxt, AppWidgetManager mgr,
    int appWidgetId) {
    int layout=R.layout.widget;

    if (Build.VERSION.SDK_INT >= Build.VERSION_CODES.JELLY_BEAN_MR1) {
        int category=
            mgr.getAppWidgetOptions(appWidgetId)
```

## HOME SCREEN APP WIDGETS

---

```
        .getInt(AppWidgetManager.OPTION_APPWIDGET_HOST_CATEGORY,
            -1);

    layout=
        (category == AppWidgetProviderInfo.WIDGET_CATEGORY_KEYGUARD)
        ? R.layout.lockscreen : R.layout.widget;
    }

    RemoteViews updateViews=
        new RemoteViews(ctxt.getPackageName(), layout);
    Intent i=new Intent(ctxt, AppWidget.class);

    i.putExtra(AppWidgetManager.EXTRA_APPWIDGET_ID, appWidgetId);

    PendingIntent pi=
        PendingIntent.getBroadcast(ctxt, appWidgetId, i,
            PendingIntent.FLAG_UPDATE_CURRENT);

    updateViews.setImageResource(R.id.left_die,
        IMAGES[(int)(Math.random() * 6)]);
    updateViews.setOnClickPendingIntent(R.id.left_die, pi);
    updateViews.setImageResource(R.id.right_die,
        IMAGES[(int)(Math.random() * 6)]);
    updateViews.setOnClickPendingIntent(R.id.right_die, pi);
    updateViews.setOnClickPendingIntent(R.id.background, pi);

    if (layout == R.layout.lockscreen) {
        updateViews.setImageResource(R.id.middle_die,
            IMAGES[(int)(Math.random() * 6)]);
        updateViews.setOnClickPendingIntent(R.id.middle_die, pi);
    }

    mgr.updateAppWidget(appWidgetId, updateViews);
}
```

First, we need to choose which layout we are working with. We assume that we are to use the original `R.layout.widget` resource by default. But, if we are on API Level 17 or higher, we can call `getAppWidgetOptions()` on the `AppWidgetManager`, to get the `Bundle` of options — the same options that we could be delivered in `onAppWidgetOptionsUpdate()` as described [in the previous section](#). One value that will be in this `Bundle` is `AppWidgetManager.OPTION_APPWIDGET_HOST_CATEGORY`, which will be an `int` with a value of `AppWidgetProviderInfo.WIDGET_CATEGORY_KEYGUARD` if our app widget is on the lockscreen. In that case, we switch to using `R.layout.lockscreen`. In addition, we know then we need to update the `middle_die` when we are updating the other dice.

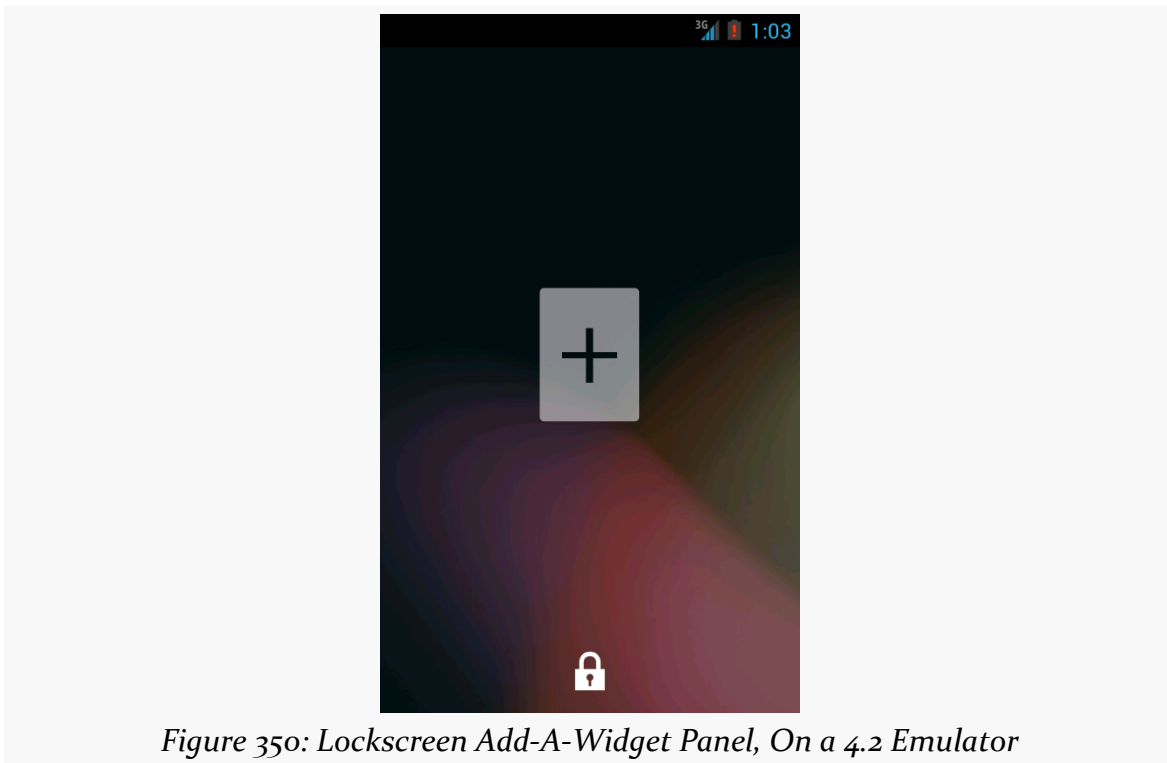
There is also a subtle change in our `getBroadcast()` call to `PendingIntent`: we pass in the app widget ID as the second parameter, whereas in `PairOfDice` we passed 0. `PendingIntent` objects are cached in our process, and by default we will get the

## HOME SCREEN APP WIDGETS

---

same `PendingIntent` when we call `getBroadcast()` for the same `Intent`. However, in our case, we may *want* two or more different `PendingIntent` objects for the same `Intent`, with differing extras (`EXTRA_APPWIDGET_ID`). Since extras are not considered when evaluating equivalence of `Intent` objects, just having different extras is insufficient to get different `PendingIntent` objects for those `Intent` objects. The second parameter to `getBroadcast()` (and `getActivity()` and `getService()`) on `PendingIntent` is a unique identifier, to differentiate between two otherwise equivalent `Intent` objects, forcing `PendingIntent` to give us distinct `PendingIntent` objects. This way, we can support two or more app widget instances, each having their own `PendingIntent` objects for their click events.

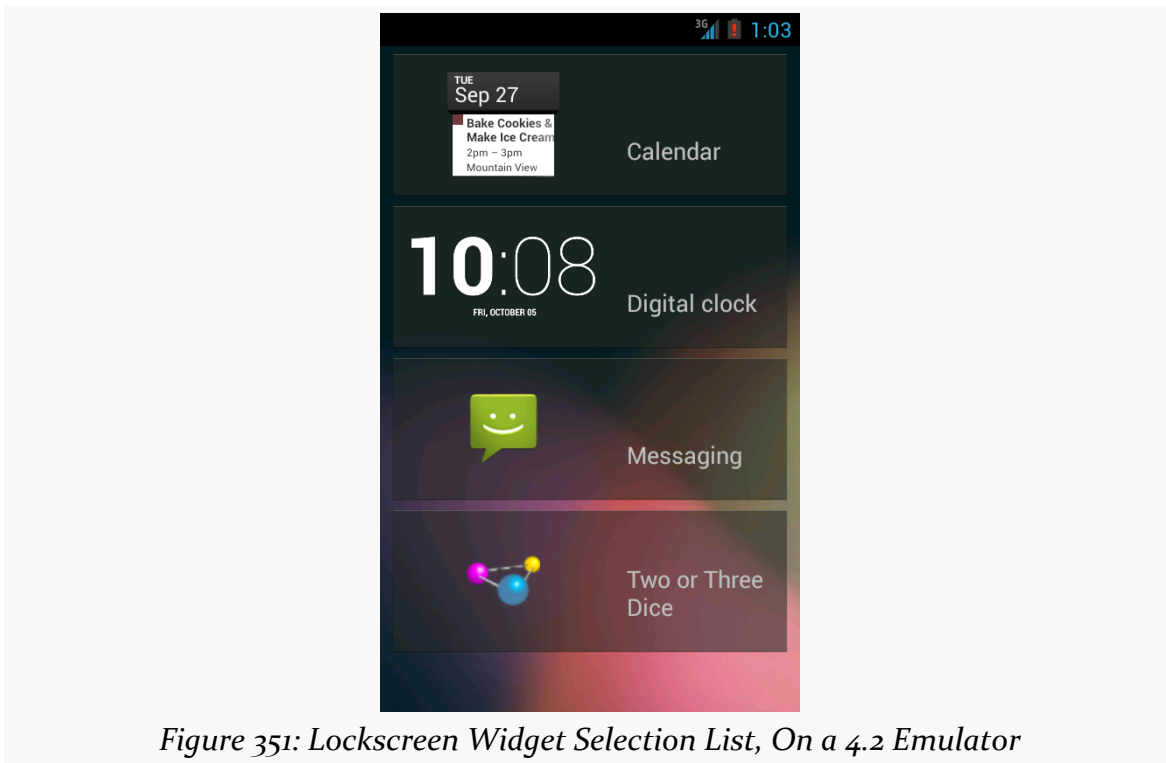
On an Android 4.2 lockscreen, you should be able to swipe to one side (e.g., a bezel swipe from left to right), to expose an option to add an app widget:



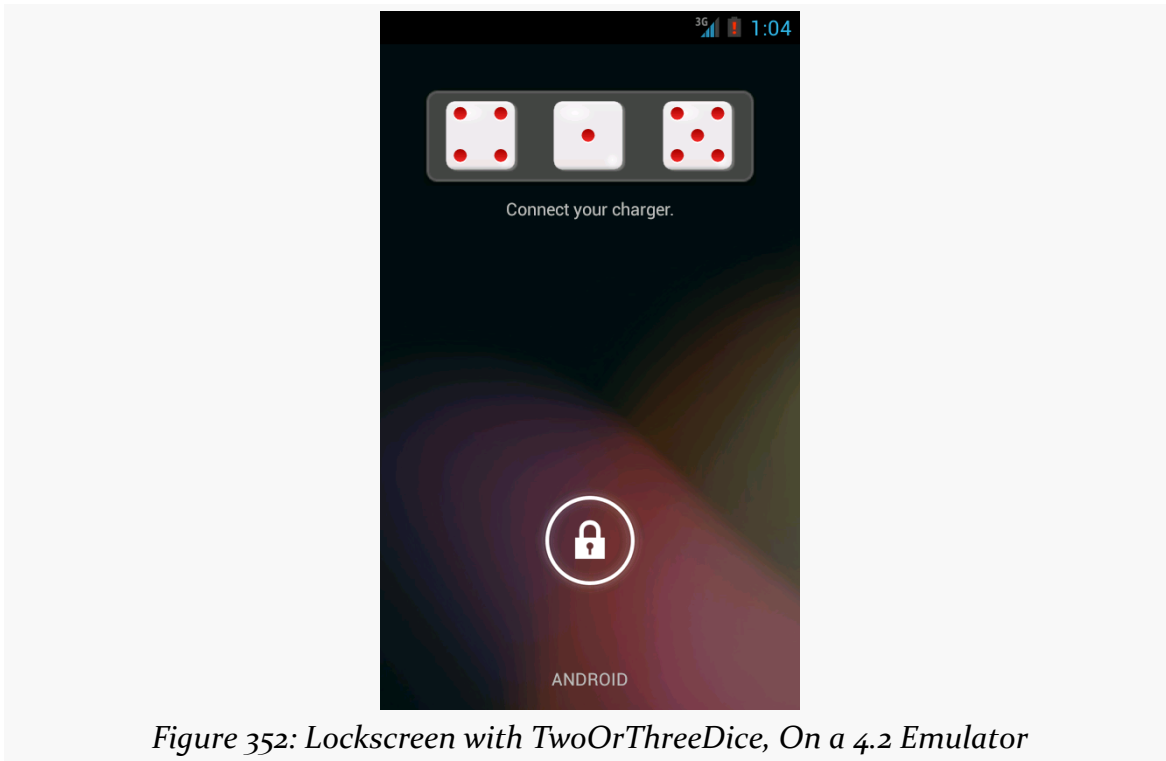
Tapping the “+” indicator (and, if needed, entering your device PIN or password), brings up an app widget chooser:

## HOME SCREEN APP WIDGETS

---



Choosing TwoOrThreeDice will then add the app widget to the lockscreen, with three dice, not two:



*Figure 352: Lockscreen with TwoOrThreeDice, On a 4.2 Emulator*

## Being a Good Host

In addition to creating your own app widgets, it is possible to host app widgets. This is mostly aimed for those creating alternative home screen applications, so they can take advantage of the same app widget framework and all the app widgets being built for it.

This is not very well documented at this juncture, but it apparently involves the `AppWidgetHost` and `AppWidgetHostView` classes. The latter is a `View` and so should be able to reside in an app widget host's UI like any other ordinary widget.

# Adapter-Based App Widgets

---

API Level 11 introduced a few new capabilities for app widgets, to make them more interactive and more powerful than before. The documentation lags a bit, though, so determining how to use these features takes a bit of exploring. Fortunately for you, the author did some of that exploring on your behalf, to save you some trouble.

## Prerequisites

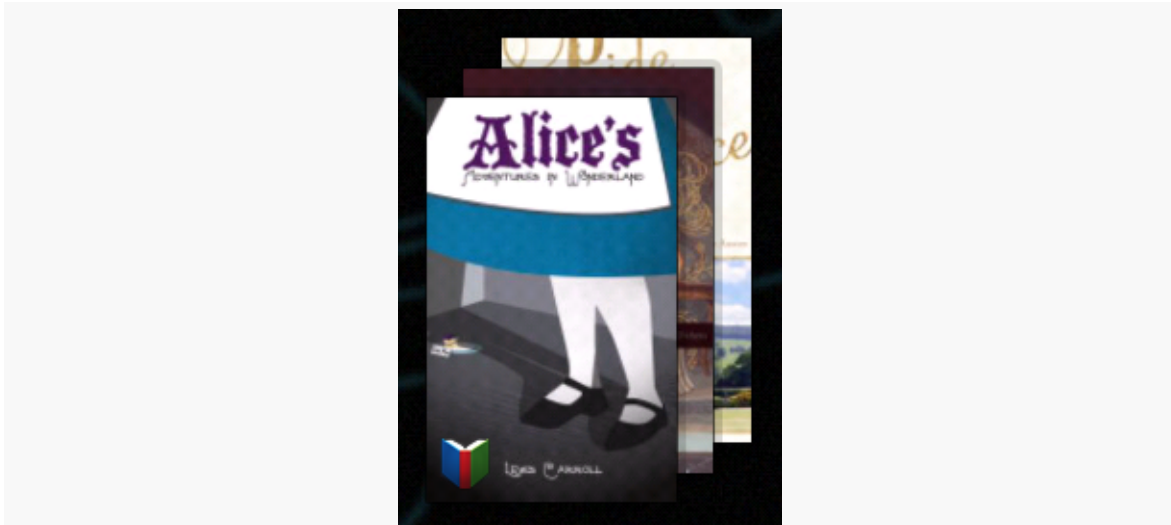
Understanding this chapter requires that you have read [the preceding chapter](#) and all of its prerequisites.

## New Widgets for App Widgets

In addition to the classic widgets available for use in app widgets and RemoteViews, five more were added for API Level 11:

1. GridView
2. ListView
3. StackView
4. ViewFlipper
5. AdapterViewFlipper

Three of these (GridView, ListView, ViewFlipper) are widgets that existed in Android since the outset. StackView is a new widget to provide a “stack of cards” UI:



*Figure 353: The Google Books app widget, showing a StackView*

AdapterViewFlipper works like a ViewFlipper, allowing you to toggle between various children with only one visible at a time. However, whereas with ViewFlipper all children are fully-instantiated View objects held by the ViewFlipper parent, AdapterViewFlipper uses the Adapter model, so only a small number of actual View objects are held in memory, no matter how many potential children there are.

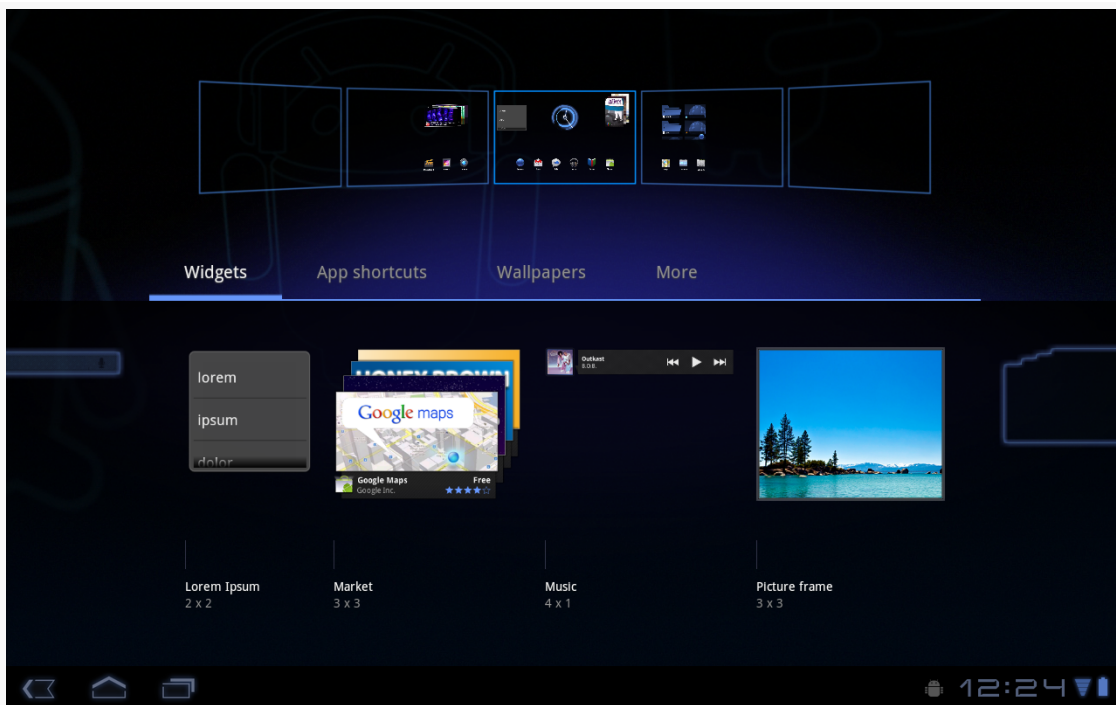
With the exception of ViewFlipper, the other four all require the use of an Adapter. This might seem odd, as there is no way to provide an Adapter to a RemoteViews. That is true, but Android 3.0 added new ways for Adapter-like communication between the app widget host (e.g., home screen) and your application. We will take an in-depth look at that in [an upcoming section](#).

## Preview Images

App widgets can now have preview images attached. Preview images are drawable resources representing a preview of what the app widget might look like on the screen. On tablets, this will be used as part of an app widget gallery, replacing the simple context menu presentation you see on Android 1.x and 2.x phones:

## ADAPTER-BASED APP WIDGETS

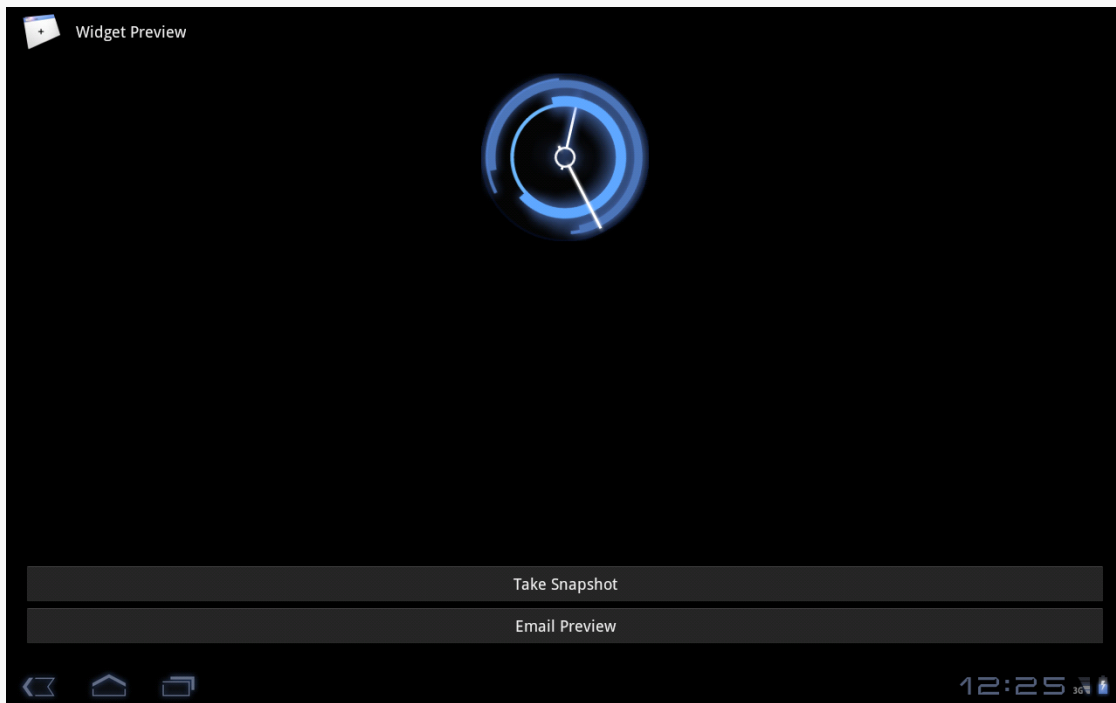
---



*Figure 354: The XOOM tablet's app widget gallery*

To create the preview image itself, the Android 3.0 emulator contains a Widget Preview application that lets you run an app widget in its own container, outside of the home screen:





*Figure 355: The Widget Preview application, showing a preview of the Analog Clock app widget*

From here, you can take a snapshot and save it to external storage, copy it to your project's `res/drawable-nodpi/` directory (indicating that there is no intrinsic density assumed for this image), and reference it in your app widget metadata via an `android:previewImage` attribute. We will see an example of such an attribute in [the next section](#).

## Adapter-Based App Widgets

In an activity, if you put a `ListView` or `GridView` into your layout, you will also need to hand it an `Adapter`, providing the actual row or cell `View` objects that make up the contents of those selection widgets.

In an app widget, this becomes a bit more complicated. The host of the app widget does not have any `Adapter` class of yours. Hence, just as we have to send the contents of the app widget's UI via a `RemoteViews`, we will need to provide the rows or cells via `RemoteViews` as well. Android, starting with API Level 11, has a `RemoteViewsService` and `RemoteViewsFactory` that you can use for this purpose.

Let's take a look, in the form of the [AppWidget/LoremWidget](#) sample project, which will put a `ListView` of 25 nonsense words into an app widget.

### The AppWidgetProvider

At its core, our `AppWidgetProvider` (named `WidgetProvider`, in a stunning display of creativity) still needs to create and configure a `RemoteViews` object with the app widget UI, then use `updateAppWidget()` to push that `RemoteViews` to the host via the `AppWidgetManager`. However, for an app widget that involves an `AdapterView`, like `ListView`, there are two more key steps:

- You have to tell the `RemoteViews` the identity of a `RemoteViewsService` that will help fill the role that the `Adapter` would in an activity
- You have to provide the `RemoteViews` with a “template” `PendingIntent` to be used when the user taps on a row or cell in the `AdapterView`, to replace the `onListItemClick()` or similar method you might have used in an activity

For example, here is `WidgetProvider` for our nonsense-word app widget:

```
package com.commonware.android.appwidget.lorem;

import android.app.PendingIntent;
import android.appwidget.AppWidgetManager;
import android.appwidget.AppWidgetProvider;
import android.content.Context;
import android.content.Intent;
import android.net.Uri;
import android.widget.RemoteViews;

public class WidgetProvider extends AppWidgetProvider {
    public static String EXTRA_WORD=
        "com.commonware.android.appwidget.lorem.WORD";

    @Override
    public void onUpdate(Context ctxt, AppWidgetManager appWidgetManager,
        int[] appWidgetIds) {
        for (int i=0; i<appWidgetIds.length; i++) {
            Intent svcIntent=new Intent(ctxt, WidgetService.class);

            svcIntent.putExtra(AppWidgetManager.EXTRA_APPWIDGET_ID, appWidgetIds[i]);
            svcIntent.setData(Uri.parse(svcIntent.toUri(Intent.URI_INTENT_SCHEME)));

            RemoteViews widget=new RemoteViews(ctxt.getPackageName(),
                R.layout.widget);

            widget.setRemoteAdapter(appWidgetIds[i], R.id.words,
                svcIntent);
        }
    }
}
```

## ADAPTER-BASED APP WIDGETS

---

```
Intent clickIntent=new Intent(ctxt, LoremActivity.class);
PendingIntent clickPI=PendingIntent
    .getActivity(ctxt, 0,
                clickIntent,
                PendingIntent.FLAG_UPDATE_CURRENT);

widget.setPendingIntentTemplate(R.id.words, clickPI);

appWidgetManager.updateAppWidget(appWidgetIds[i], widget);
}

super.onUpdate(ctxt, appWidgetManager, appWidgetIds);
}
}
```

The call to `setRemoteAdapter()` is where we point the `RemoteViews` to our `RemoteViewsService` for our `AdapterView` widget. The main rules for the `Intent` used to identify the `RemoteViewsService` are:

1. The service must be identified by its data (`Uri`), so even if you create the `Intent` via the `Context-and-Class` constructor, you will need to convert that into a `Uri` via `toUri(Intent.URI_INTENT_SCHEME)` and set that as the `Uri` for the `Intent`. Why? While your application has access to your `RemoteViewsService` Class object, the app widget host will not, and so we need something that will work across process boundaries. You could elect to add your own `<intent-filter>` to the `RemoteViewsService` and use an `Intent` based on that, but that would make your service more publicly visible than you might want.
2. Any extras that you package on the `Intent` — such as the app widget ID in this case — will be on the `Intent` that is delivered to the `RemoteViewsService` when it is invoked by the app widget host.

Note that this project uses the original form of `setRemoteAdapter()`, taking the app widget ID as the first parameter. That method signature was deprecated as of API Level 14 (Android 4.0 / Ice Cream Sandwich), as supplying the app widget ID was superfluous. Once Honeycomb tablets are mostly upgraded to Ice Cream Sandwich, you may wish to consider switching to the new two-parameter flavor of `setRemoteAdapter()`.

The call to `setPendingIntentTemplate()` is where we provide a `PendingIntent` that will be used as the template for all row or cell clicks. As we will see in a bit, the underlying `Intent` in the `PendingIntent` will have more data added to it by our `RemoteViewsFactory`.

In all other respects, our `WidgetProvider` is unremarkable compared to other app widgets. It will need to be registered in the manifest as a `<receiver>`, as with any other app widget.

### The RemoteViewsService

Android supplies a `RemoteViewsService` class that you will need to extend, and this class is the one you must register with the `RemoteViews` for an `AdapterView` widget. For example, here is `WidgetService` (once again, a highly creative name) from the `LoremWidget` project:

```
package com.commonware.android.appwidget.lorem;

import android.content.Intent;
import android.widget.RemoteViewsService;

public class WidgetService extends RemoteViewsService {
    @Override
    public RemoteViewsFactory onGetViewFactory(Intent intent) {
        return(new LoremViewsFactory(this.getApplicationContext(),
                                     intent));
    }
}
```

As you can see, this service is practically trivial. You have to override one method, `onGetViewFactory()`, which will return the `RemoteViewsFactory` to use for supplying rows or cells for the `AdapterView`. You are passed in an `Intent`, the one used in the `setRemoteAdapter()` call. Hence, if you have more than one `AdapterView` widget in your app widget, you could elect to have two `RemoteViewsService` implementations, or one that discriminates between the two widgets via something in the `Intent` (e.g., custom action string). In our case, we only have one `AdapterView`, so we create an instance of a `LoremViewFactory` and return it. Google demonstrates using `getApplicationContext()` here to supply the `Context` object to `RemoteViewsFactory`, instead of using the `Service` as a `Context` — it is unclear at this time why this is.

Another thing different about the `RemoteViewsService` is how it is registered in the manifest:

```
<?xml version="1.0" encoding="utf-8"?>
<manifest xmlns:android="http://schemas.android.com/apk/res/android"
    package="com.commonware.android.appwidget.lorem"
    android:versionCode="1"
    android:versionName="1.0">
```

```
<uses-sdk
  android:minSdkVersion="11"
  android:targetSdkVersion="11"/>

<application
  android:icon="@drawable/ic_launcher"
  android:label="@string/app_name">
  <activity
    android:name="LoremActivity"
    android:label="@string/app_name"
    android:theme="@android:style/Theme.NoDisplay">
    <intent-filter>
      <action android:name="android.intent.action.MAIN"/>

      <category android:name="android.intent.category.LAUNCHER"/>
    </intent-filter>
  </activity>

  <receiver
    android:name="WidgetProvider"
    android:icon="@drawable/ic_launcher"
    android:label="@string/app_name">
    <intent-filter>
      <action android:name="android.appwidget.action.APPWIDGET_UPDATE"/>
    </intent-filter>

    <meta-data
      android:name="android.appwidget.provider"
      android:resource="@xml/widget_provider"/>
  </receiver>

  <service
    android:name="WidgetService"
    android:permission="android.permission.BIND_REMOTEVIEWS"/>
</application>
</manifest>
```

Note the use of `android:permission`, specifying that whoever sends an Intent to `WidgetService` must hold the `BIND_REMOTEVIEWS` permission. This can only be held by the operating system. This is a security measure, so arbitrary applications cannot find out about your service and attempt to spoof being the OS and cause you to supply them with `RemoteViews` for the rows, as this might leak private data.

### The RemoteViewsFactory

A `RemoteViewsFactory` interface implementation looks and feels a lot like an `Adapter`. In fact, one could imagine that the Android developer community might create `CursorRemoteViewsFactory` and `ArrayRemoteViewsFactory` and such to further simplify writing these classes.

## ADAPTER-BASED APP WIDGETS

---

For example, here is LoremViewsFactory, the one used by the LoremWidget project:

```
package com.commonware.android.appwidget.lorem;

import android.appwidget.AppWidgetManager;
import android.content.Context;
import android.content.Intent;
import android.os.Bundle;
import android.widget.RemoteViews;
import android.widget.RemoteViewsService;

public class LoremViewsFactory implements
    RemoteViewsService.RemoteViewsFactory {
    private static final String[] items= { "lorem", "ipsum", "dolor",
        "sit", "amet", "consectetur", "adipiscing", "elit", "morbi",
        "vel", "ligula", "vitae", "arcu", "aliquet", "mollis", "etiam",
        "vel", "erat", "placerat", "ante", "porttitor", "sodales",
        "pellentesque", "augue", "purus" };
    private Context ctxt=null;
    private int appWidgetId;

    public LoremViewsFactory(Context ctxt, Intent intent) {
        this.ctxt=ctxt;
        appWidgetId=
            intent.getIntExtra(AppWidgetManager.EXTRA_APPWIDGET_ID,
                AppWidgetManager.INVALID_APPWIDGET_ID);
    }

    @Override
    public void onCreate() {
        // no-op
    }

    @Override
    public void onDestroy() {
        // no-op
    }

    @Override
    public int getCount() {
        return(items.length);
    }

    @Override
    public RemoteViews getViewAt(int position) {
        RemoteViews row=
            new RemoteViews(ctxt.getPackageName(), R.layout.row);

        row.setTextViewText(android.R.id.text1, items[position]);

        Intent i=new Intent();
        Bundle extras=new Bundle();

        extras.putString(WidgetProvider.EXTRA_WORD, items[position]);
    }
}
```

## ADAPTER-BASED APP WIDGETS

---

```
extras.putInt(AppWidgetManager.EXTRA_APPWIDGET_ID, appWidgetId);
i.putExtras(extras);
row.setOnClickListener(android.R.id.text1, i);

return(row);
}

@Override
public RemoteViews getLoadingView() {
return(null);
}

@Override
public int getViewTypeCount() {
return(1);
}

@Override
public long getItemId(int position) {
return(position);
}

@Override
public boolean hasStableIds() {
return(true);
}

@Override
public void onDataChange() {
// no-op
}
}
```

You need to implement a handful of methods that have the same roles in a RemoteViewsFactory as they do in an Adapter, including:

1. getCount()
2. getViewTypeCount()
3. getItemId()
4. hasStableIds()

In addition, you have onCreate() and onDestroy() methods that you must implement, even if they do nothing, to satisfy the interface.

You will need to implement getLoadingView(), which will return a RemoteViews to use as a placeholder while the app widget host is getting the real contents for the app widget. If you return null, Android will use a default placeholder.

## ADAPTER-BASED APP WIDGETS

---

The bulk of your work will go in `getViewAt()`. This serves the same role as `getView()` does for an Adapter, in that it returns the row or cell View for a given position in your data set. However:

1. You have to return a RemoteViews, instead of a View, just as you have to use RemoteViews for the main content of the app widget in your AppWidgetProvider
2. There is no recycling, so you do not get a View (or RemoteViews) back to somehow repopulate, meaning you will create a new RemoteViews every time

The impact of the latter is that you do not want to put large data sets into an app widget, as scrolling may get sluggish, just as you do not want to implement an Adapter without recycling unused View objects.

In `LoremViewsFactory`, the `getViewAt()` implementation creates a RemoteViews for a custom row layout, cribbed from one in the Android SDK:

```
<?xml version="1.0" encoding="utf-8"?>
<!-- Copyright (C) 2006 The Android Open Source Project

Licensed under the Apache License, Version 2.0 (the "License");
you may not use this file except in compliance with the License.
You may obtain a copy of the License at

    http://www.apache.org/licenses/LICENSE-2.0

Unless required by applicable law or agreed to in writing, software
distributed under the License is distributed on an "AS IS" BASIS,
WITHOUT WARRANTIES OR CONDITIONS OF ANY KIND, either express or implied.
See the License for the specific language governing permissions and
limitations under the License.
-->
<TextView xmlns:android="http://schemas.android.com/apk/res/android"
    android:id="@android:id/text1"
    android:layout_width="match_parent"
    android:layout_height="wrap_content"
    android:textAppearance="?android:attr/textAppearanceLarge"
    android:gravity="center_vertical"
    android:paddingLeft="6dip"
    android:minHeight="?android:attr/listPreferredItemHeight"
/>
```

Then, `getViewAt()` pours in a word from the static String array of nonsense words into that RemoteViews for the TextView inside it. It also creates an Intent and puts the nonsense word in as an EXTRA\_WORD extra, then provides that Intent to `setOnClickFillInIntent()`. In addition, it adds the app widget instance ID as an



## ADAPTER-BASED APP WIDGETS

---

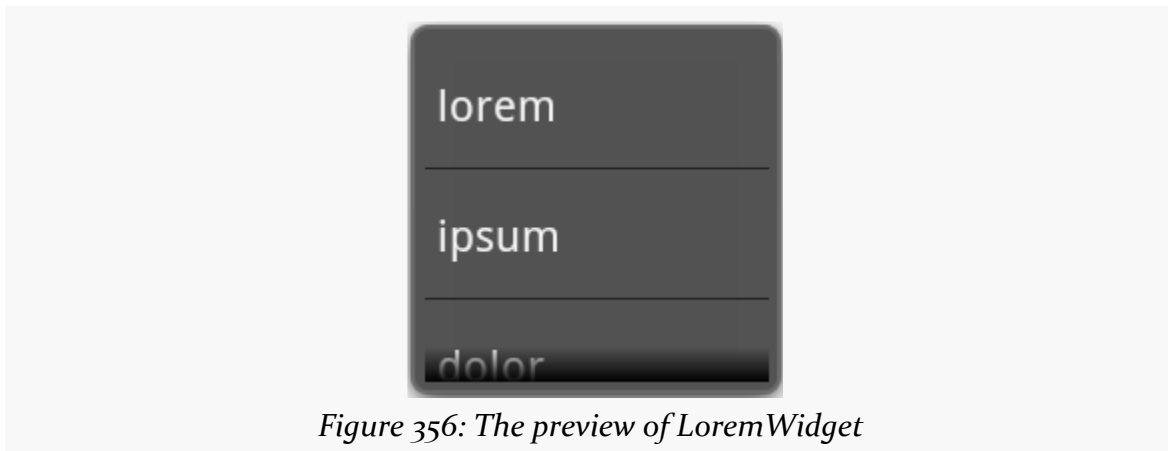
extra, reusing the framework's own `AppWidgetManager.EXTRA_APPWIDGET_ID` as the key. The contents of the “fill-in” Intent are merged into the “template” `PendingIntent` from `setPendingIntentTemplate()`, and the resulting `PendingIntent` is what is invoked when the user taps on an item in the `AdapterView`. The fully-configured `RemoteViews` is then returned.

### The Rest of the Story

The app widget metadata needs no changes related to Adapter-based app widget contents. However, `LoremWidget` does add the `android:previewImage` attribute:

```
<appwidget-provider xmlns:android="http://schemas.android.com/apk/res/android"
    android:minWidth="146dip"
    android:minHeight="146dip"
    android:updatePeriodMillis="0"
    android:initialLayout="@layout/widget"
    android:autoAdvanceViewId="@+id/words"
    android:previewImage="@drawable/preview"
    android:resizeMode="vertical"
/>
```

This points to the `res/drawable-nodpi/preview.png` file that represents a “widgetshot” of the app widget in isolation, obtained from the Widget Preview application:



*Figure 356: The preview of LoremWidget*

Also, the metadata specifies `android:resizeMode="vertical"`. This attribute is new to Android 3.1, and allows the app widget to be resized by the user (in this case, only in the vertical direction, to show more rows). Older versions of Android will ignore this attribute, and the app widget will remain in your requested size. You can use

## ADAPTER-BASED APP WIDGETS

---

vertical, horizontal, or both (via the pipe operator) as values for `android:resizeMode`.

When the user taps on an item in the list, our `PendingIntent` is set to bring up `LoremActivity`. This activity has `android:theme="@android:style/Theme.NoDisplay"` set in the manifest, meaning that it will not have its own user interface. Rather, it will extract our `EXTRA_WORD` — and the app widget ID — out of the `Intent` used to launch the activity and displays them in a `Toast` before finishing:

```
package com.commonware.android.appwidget.lorem;

import android.app.Activity;
import android.appwidget.AppWidgetManager;
import android.os.Bundle;
import android.widget.Toast;

public class LoremActivity extends Activity {
    @Override
    public void onCreate(Bundle state) {
        super.onCreate(state);

        String word=getIntent().getStringExtra(WidgetProvider.EXTRA_WORD);

        if (word == null) {
            word="We did not get a word!";
        }

        Toast.makeText(this,
            String.format("#%d: %s",

getIntent().getIntExtra(AppWidgetManager.EXTRA_APPWIDGET_ID,
AppWidgetManager.INVALID_APPWIDGET_ID),
            word), Toast.LENGTH_LONG).show();

        finish();
    }
}
```

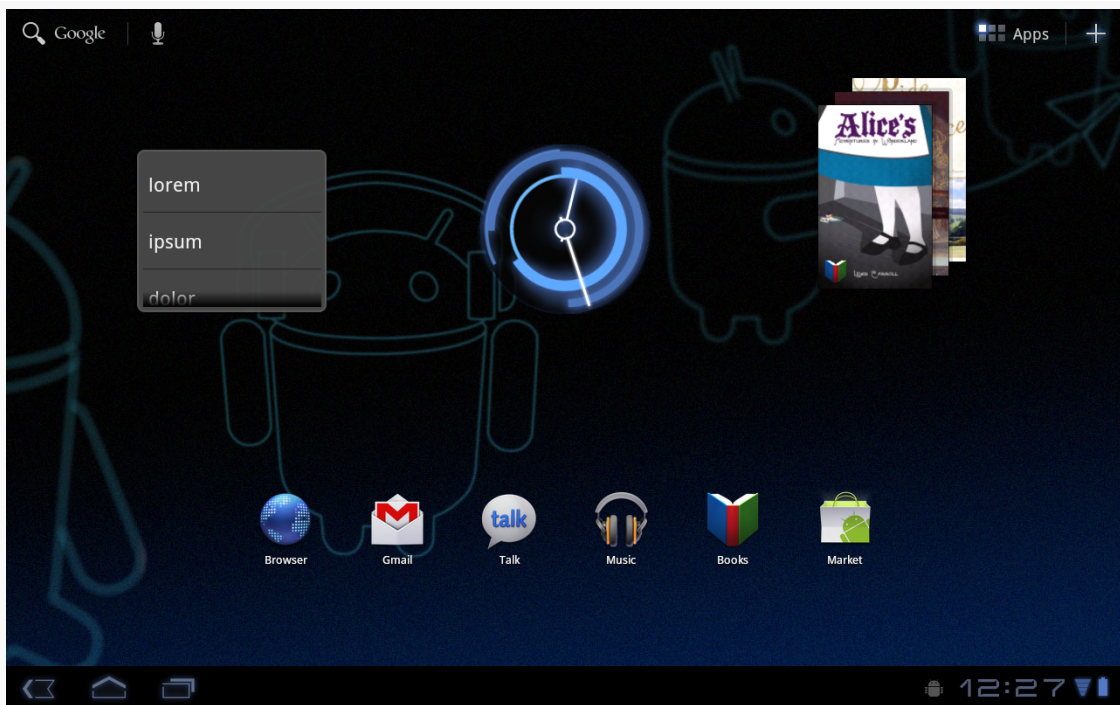
### The Results

When you compile and install the application, nothing new shows up in the home screen launcher, because we have no activity defined to respond to `ACTION_MAIN` and `CATEGORY_HOME`. This would be unusual for an application distributed through the Play Store, as users often get confused if they install something and then do not know how to start it. However, for the purposes of this example, we should be fine, as readers of programming books never get confused about such things.

## ADAPTER-BASED APP WIDGETS

---

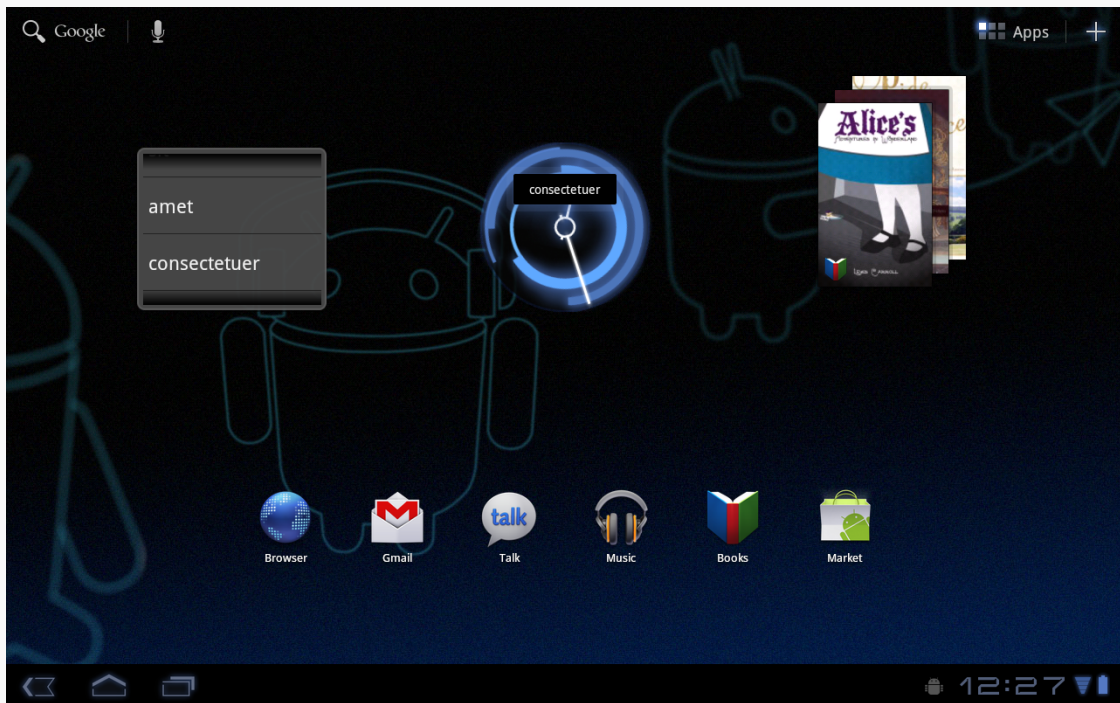
However, if you bring up the app widget gallery (e.g., long-tap on the home screen of a Motorola XOOM), you will see LoremWidget there, complete with preview image. You can drag it into one of the home screen panes and position it. When done, the app widget appears as expected:



*Figure 357: A XOOM home screen, showing the LoremWidget on the left*

The ListView is live and can be scrolled. Tapping an entry brings up the corresponding Toast:

## ADAPTER-BASED APP WIDGETS

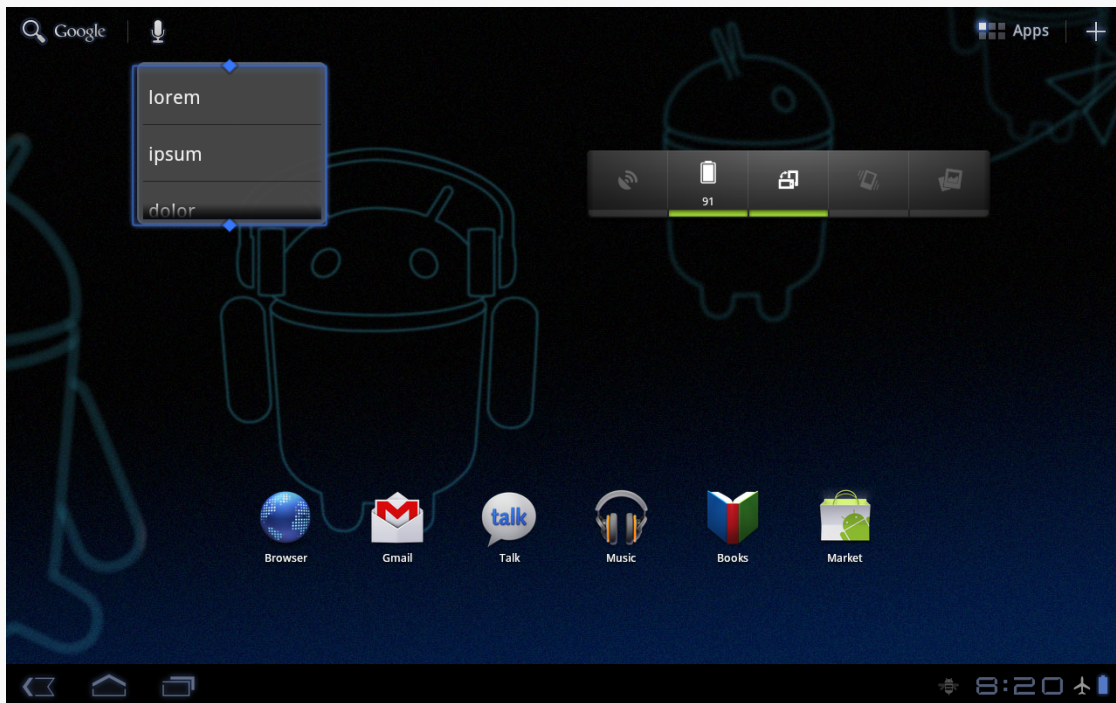


*Figure 358: A XOOM home screen, showing the LoremWidget on the left*

The above image illustrates that a Toast is not a great UI choice on a tablet, given the relative size of the Toast compared to the screen. Users will be far more likely to miss the Toast than ever before.

If the user long-taps on the app widget, they will be able to reposition it. On Android 3.1 and beyond, when they lift their finger after the long-tap, the app widget will show resize handles on the sides designated by your `android:resizeMode` attribute:

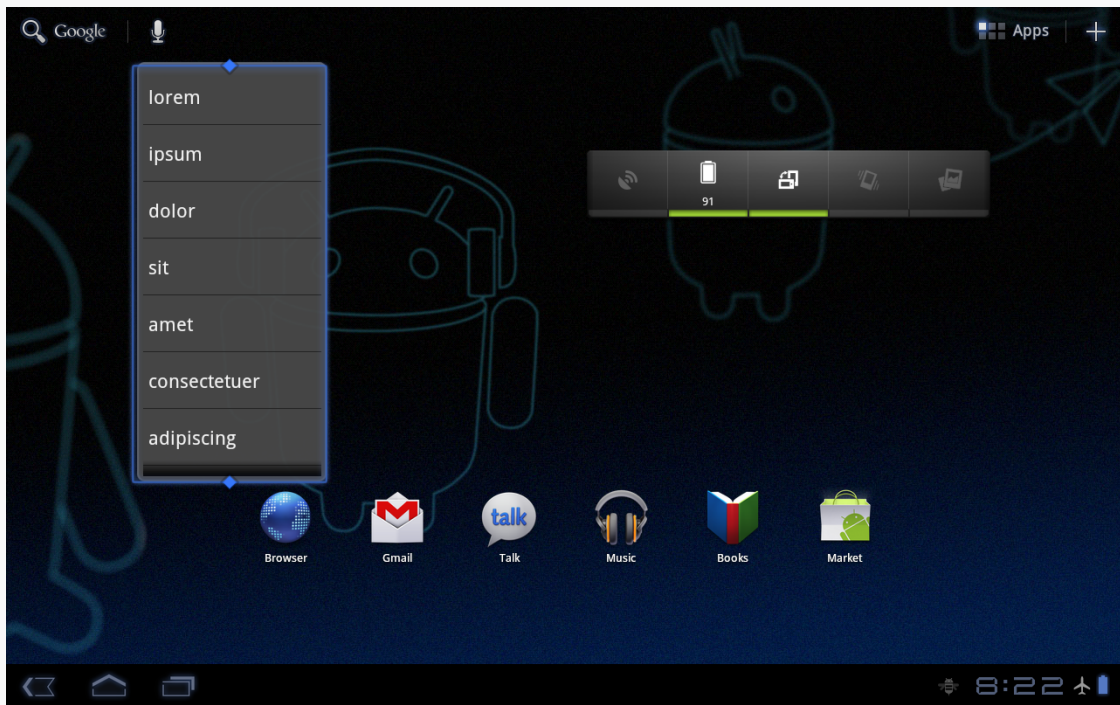
## ADAPTER-BASED APP WIDGETS



*Figure 359: A phone home screen, showing the LoremWidget on the left, with resize handles*

The user can then drag those handles to expand or shrink the app widget in the specified dimensions:

## ADAPTER-BASED APP WIDGETS



*Figure 360: The resized LoremWidget*



# Content Provider Theory

---

Android publishes data to you via an abstraction known as a “content provider”. Access to contacts and the call log, for example, are given to you via a set of content providers. In a few places, Android expects you to supply a content provider, such as for integrating your own search suggestions with the Android Quick Search Box. And, content providers are one way for you to supply data to third party applications, or to consume information from third party applications. As such, content providers have the potential to be something you would encounter frequently, even if in practice they do not seem used much.

## Prerequisites

Understanding this chapter requires that you have read the core chapters, particularly the one on [working with local databases](#).

## Using a Content Provider

Any `Uri` in Android that begins with the `content://` scheme represents a resource served up by a content provider. Content providers offer data encapsulation using `Uri` instances as handles – you neither know nor care where the data represented by the `Uri` comes from, so long as it is available to you when needed. The data could be stored in a SQLite database, or in flat files, or retrieved off a device, or be stored on some far-off server accessed over the Internet.

Given a `Uri`, you may be able to perform basic CRUD (create, read, update, delete) operations using a content provider. `Uri` instances can represent either collections or individual pieces of content. Given a collection `Uri`, you may be able to create new pieces of content via insert operations. Given an instance `Uri`, you may be able to



read data represented by the `Uri`, update that data, or delete the instance outright. Or, given an `Uri`, you may be able to open up a handle to what amounts to a file, that you can read and, possibly, write to.

These are all phrased as “may” because the content provider system is a facade. The actual implementation of a content provider dictates what you can and cannot do, and not all content providers will support all capabilities.

### Pieces of Me

The simplified model of the construction of a content `Uri` is the scheme, the namespace of data, and, optionally, the instance identifier, all separated by slashes in URL-style notation. The scheme of a content `Uri` is always `content://`.

So, a content `Uri` of `content://constants/5` represents the constants instance with an identifier of 5.

The combination of the scheme and the namespace is known as the “base `Uri`” of a content provider, or a set of data supported by a content provider. In the example above, `content://constants` is the base `Uri` for a content provider that serves up information about “constants” (in this case, physical constants).

The base `Uri` can be more complicated. For example, if the base `Uri` for contacts were `content://contacts/people`, the contacts content provider may serve up other data using other base `Uri` values.

The base `Uri` represents a collection of instances. The base `Uri` combined with an instance identifier (e.g., 5) represents a single instance.

Most of the Android APIs expect these to be `Uri` objects, though in common discussion, it is simpler to think of them as strings. The `Uri.parse()` static method creates a `Uri` out of the string representation.

### Getting a Handle

So, where do these `Uri` instances come from?

The most popular starting point, if you know the type of data you want to work with, is to get the base `Uri` from the content provider itself in code. For example, `CONTENT_URI` is the base `Uri` for contacts represented as people — this maps to `content://contacts/people`. If you just need the collection, this `Uri` works as-is; if

you need an instance and know its identifier, you can call `addId()` on the `Uri` to inject it, so you have a `Uri` for the instance.

You might also get `Uri` instances handed to you from other sources, such as getting `Uri` handles for contacts via sub-activities responding to `ACTION_PICK` intents. In this case, the `Uri` is truly an opaque handle... unless you decide to pick it apart using the various getters on the `Uri` class.

You can also hard-wire literal `String` objects (e.g., `"content://contacts/people"`) and convert them into `Uri` instances via `Uri.parse()`. This is not an ideal solution, as the base `Uri` values could conceivably change over time. For example, the contacts content provider's base `Uri` is no longer `content://contacts/people` due to an overhaul of that subsystem. However, when you integrate with content providers from third parties, most likely you will not have a choice but to “hard-wire” in the content `Uri` based on a string.

### The Database-Style API

Of the two flavors of API that a content provider may support, the database-style API is more prevalent. Using a `ContentResolver`, you can perform standard “CRUD” operations (create, read, update, delete) using what looks like a SQL interface.

#### Makin' Queries

Given a base `Uri`, you can run a query to return data out of the content provider related to that `Uri`. This has much of the feel of SQL: you specify the “columns” to return, the constraints to determine which “rows” to return, a sort order, etc. The difference is that this request is being made of a content provider, not directly of some database (e.g., `SQLite`).

While you can conduct a query using a `ContentResolver`, another approach is the `managedQuery()` method available to your activity. This method takes five parameters:

- The base `Uri` of the content provider to query, or the instance `Uri` of a specific object to query
- An array of properties (think “columns”) from that content provider that you want returned by the query
- A constraint statement, functioning like a SQL `WHERE` clause

## CONTENT PROVIDER THEORY

---

- An optional set of parameters to bind into the constraint clause, replacing any ? that appear there
- An optional sort statement, functioning like a SQL ORDER BY clause

This method returns a Cursor object, which you can use to retrieve the data returned by the query.

This will hopefully make more sense given an example. This chapter shows some sample bits of code from the [ContentProvider/ConstantsPlus](#) sample project. This is the same basic application as was first shown back in the [chapter on database access](#), but rewritten to pull the database logic into a content provider, which is then used by the activity.

Here, we make a call to our ContentProvider, from our activity, via managedQuery():

```
@Override
public void onCreate(Bundle savedInstanceState) {
    super.onCreate(savedInstanceState);

    constantsCursor=managedQuery(Provider.Constants.CONTENT_URI,
                                PROJECTION, null, null, null);

    ListAdapter adapter=new SimpleCursorAdapter(this,
                                                R.layout.row, constantsCursor,
                                                new String[] {Provider.Constants.TITLE,
                                                            Provider.Constants.VALUE},
                                                new int[] {R.id.title, R.id.value});

    setListAdapter(adapter);
    registerContextMenu(getListView());
}
```

In the call to managedQuery(), we provide:

1. The Uri passed into the activity by the caller (CONTENT\_URI), in this case representing the collection of physical constants managed by the content provider
2. A list of properties to retrieve (see code below)
3. Three null values, indicating that we do not need a constraint clause (the Uri represents the instance we need), nor parameters for the constraint, nor a sort order (we should only get one entry back)

The biggest “magic” here is the list of properties. The lineup of what properties are possible for a given content provider should be provided by the documentation (or source code) for the content provider itself. In this case, we define logical values on

the Provider content provider implementation class that represent the various properties (namely, the unique identifier, the display name or title, and the value of the constant).

### Adapting to the Circumstances

Now that we have a Cursor via `managedQuery()`, we have access to the query results and can do whatever we want with them. You might, for example, manually extract data from the Cursor to populate widgets or other objects.

However, if the goal of the query was to return a list from which the user should choose an item, you probably should consider using `SimpleCursorAdapter`. This class bridges between the Cursor and a selection widget, such as a `ListView` or `Spinner`. Pour the Cursor into a `SimpleCursorAdapter`, hand the adapter off to the widget, and you are set — your widget will show the available options.

After executing the `managedQuery()` and getting the Cursor, `ConstantsBrowser` creates a `SimpleCursorAdapter` with the following parameters:

1. The activity (or other Context) creating the adapter; in this case, the `ConstantsBrowser` itself
2. The identifier for a layout to be used for rendering the list entries (`R.layout.row`)
3. The cursor (`constantsCursor`)
4. The properties to pull out of the cursor and use for configuring the list entry View instances (`TITLE` and `VALUE`)
5. The corresponding identifiers of `TextView` widgets in the list entry layout that those properties should go into (`R.id.title` and `R.id.value`)

If you need more control over the views than you can reasonably achieve with the stock view construction logic, subclass `SimpleCursorAdapter` and override `getView()` to create your own widgets to go into the list, as demonstrated earlier in this book.

And, of course, you can manually manipulate the Cursor (e.g., `moveToFirst()`, `getString()`), just like you can with a database Cursor.

### Give and Take

Of course, content providers would be astonishingly weak if you couldn't add or remove data from them, only update what is there. Fortunately, content providers offer these abilities as well.

To insert data into a content provider, you have two options available on the `ContentProvider` interface (available through `getContentProvider()` to your activity):

- Use `insert()` with a collection `Uri` and a `ContentValues` structure describing the initial set of data to put in the row
- Use `bulkInsert()` with a collection `Uri` and an array of `ContentValues` structures to populate several rows at once

The `insert()` method returns a `Uri` for you to use for future operations on that new object. The `bulkInsert()` method returns the number of created rows; you would need to do a query to get back at the data you just inserted.

For example, here is a snippet of code from `ConstantsBrowser` to insert a new constant into the content provider, given a `DialogWrapper` that can provide access to the title and value of the constant:

```
private void processAdd(DialogWrapper wrapper) {
    ContentValues values=new ContentValues(2);

    values.put(Provider.Constants.TITLE, wrapper.getTitle());
    values.put(Provider.Constants.VALUE, wrapper.getValue());

    getContentResolver().insert(Provider.Constants.CONTENT_URI,
                                values);
    constantsCursor.requery();
}
```

Since we already have an outstanding `Cursor` for the content provider's contents, we call `requery()` on that to update the `Cursor`'s contents. This, in turn, will update any `SimpleCursorAdapter` you may have wrapping the `Cursor` — and that will update any selection widgets (e.g., `ListView`) you have using the adapter.

To delete one or more rows from the content provider, use the `delete()` method on `ContentResolver`. This works akin to a SQL `DELETE` statement and takes three parameters:

- A `Uri` representing the collection (or instance) from which you wish to delete rows
- A constraint statement, functioning like a SQL `WHERE` clause, to determine which rows should be deleted
- An optional set of parameters to bind into the constraint clause, replacing any `?` that appear there

### The File System-Style API

Sometimes, what you are trying to retrieve does not look like a set of rows and columns, but rather looks like a file. For example, the `MediaStore` content provider manages the index of all music, video, and image files available on external storage, and you can use `MediaStore` to open up any such file you find.

Some content providers, like `MediaStore`, support both the database-style and file system-style APIs — you query to find media that matches your criteria, then can open some file that matches. Other content providers might only support the file system-style API.

Given a `Uri` that represents some file managed by the content provider, you can use `openInputStream()` and `openOutputStream()` on a `ContentResolver` to access an `InputStream` or `OutputStream`, respectively. Note, though, that not all content providers may support both modes. For example, a content provider that serves files stored inside the application (e.g., assets in the APK file), you will not be able to get an `OutputStream` to modify the content.

### Building Content Providers

Building a content provider is probably a very tedious task. There are many requirements of a content provider, in terms of methods to implement and public data members to supply. And, until you try using it, you have no great way of telling if you did any of it correctly (versus, say, building an activity and getting validation errors from the resource compiler).

That being said, building a content provider is of huge importance if your application wishes to make data available to other applications. If your application is keeping its data solely to itself, you may be able to avoid creating a content provider, just accessing the data directly from your activities. But, if you want your data to possibly be used by others — for example, you are building a feed reader and you

want other programs to be able to access the feeds you are downloading and caching — then a content provider is right for you.

### First, Some Dissection

The content `Uri` is the linchpin behind accessing data inside a content provider. When using a content provider, all you really need to know is the provider's base `Uri`; from there you can run queries as needed, or construct a `Uri` to a specific instance if you know the instance identifier.

When building a content provider, though, you need to know a bit more about the innards of the content `Uri`.

A content `Uri` has two to four pieces, depending on situation:

1. It always has a scheme (`content://`), indicating it is a content `Uri` instead of a `Uri` to a Web resource (`http://`).
2. It always has an authority, which is the first path segment after the scheme. The authority is a unique string identifying the content provider that handles the content associated with this `Uri`.
3. It may have a data type path, which is the list of path segments after the authority and before the instance identifier (if any). The data type path can be empty, if the content provider only handles one type of content. It can be a single path segment (`foo`) or a chain of path segments (`foo/bar/goo`) as needed to handle whatever data access scenarios the content provider requires.
4. It may have an instance identifier, which is an integer identifying a specific piece of content. A content `Uri` without an instance identifier refers to the collection of content represented by the authority (and, where provided, the data path).

For example, a content `Uri` could be as simple as `content://sekrits`, which would refer to the collection of content held by whatever content provider was tied to the `sekrits` authority (e.g., `SecretsProvider`). Or, it could be as complex as `content://sekrits/card/pin/17`, which would refer to a piece of content (identified as 17) managed by the `sekrits` content provider that is of the data type `card/pin`.

### Next, Some Typing

Next, you need to come up with some MIME types corresponding with the content your content provider will provide.

Android uses both the content `Uri` and the MIME type as ways to identify content on the device. A collection content `Uri` — or, more accurately, the combination of authority and data type path — should map to a pair of MIME types. One MIME type will represent the collection; the other will represent an instance. These map to the `Uri` patterns above for no-identifier and identifier, respectively. As you saw earlier in this book, you can fill in a MIME type into an `Intent` to route the `Intent` to the proper activity (e.g., `ACTION_PICK` on a collection MIME type to call up a selection activity to pick an instance out of that collection).

The collection MIME type should be of the form `vnd.X.cursor.dir/Y`, where `X` is the name of your firm, organization, or project, and `Y` is a dot-delimited type name. So, for example, you might use `vnd.tlagency.cursor.dir/sekrits.card.pin` as the MIME type for your collection of secrets.

The instance MIME type should be of the form `vnd.X.cursor.item/Y`, usually for the same values of `X` and `Y` as you used for the collection MIME type (though that is not strictly required).

### Implementing the Database-Style API

Just as an activity and receiver are both Java classes, so is a content provider. So, the big step in creating a content provider is crafting its Java class, with a base class of `ContentProvider`.

In your subclass of `ContentProvider`, you are responsible for implementing five methods that, when combined, perform the services that a content provider is supposed to offer to activities wishing to create, read, update, or delete content via the database-style API.

#### Implement `onCreate()`

As with an activity, the main entry point to a content provider is `onCreate()`. Here, you can do whatever initialization you want. In particular, here is where you should lazy-initialize your data store. For example, if you plan on storing your data in such-and-so directory on an SD card, with an XML file serving as a “table of contents”, you



should check and see if that directory and XML file are there and, if not, create them so the rest of your content provider knows they are out there and available for use.

Similarly, if you have rewritten your content provider sufficiently to cause the data store to shift structure, you should check to see what structure you have now and adjust it if what you have is out of date.

### Implement query()

As one might expect, the `query()` method is where your content provider gets details on a query some activity wants to perform. It is up to you to actually process said query.

The query method gets, as parameters:

1. A `Uri` representing the collection or instance being queried
2. A `String` array representing the list of properties that should be returned
3. A `String` representing what amounts to a `SQL WHERE` clause, constraining which instances should be considered for the query results
4. A `String` array representing values to “pour into” the `WHERE` clause, replacing any ? found there
5. A `String` representing what amounts to a `SQL ORDER BY` clause

You are responsible for interpreting these parameters however they make sense and returning a `Cursor` that can be used to iterate over and access the data.

As you can imagine, these parameters are aimed towards people using a `SQLite` database for storage. You are welcome to ignore some of these parameters (e.g., you elect not to try to roll your own `SQL WHERE` clause parser), but you need to document that fact so activities only attempt to query you by instance `Uri` and not using parameters you elect not to handle.

### Implement insert()

Your `insert()` method will receive a `Uri` representing the collection and a `ContentValues` structure with the initial data for the new instance. You are responsible for creating the new instance, filling in the supplied data, and returning a `Uri` to the new instance.

### Implement update()

Your `update()` method gets the `Uri` of the instance or collection to change, a `ContentValues` structure with the new values to apply, a `String` for a SQL `WHERE` clause, and a `String` array with parameters to use to replace `?` found in the `WHERE` clause. Your responsibility is to identify the instance(s) to be modified (based on the `Uri` and `WHERE` clause), then replace those instances' current property values with the ones supplied.

This will be annoying, unless you are using `SQLite` for storage. Then, you can pretty much pass all the parameters you received to the `update()` call to the database, though the `update()` call will vary slightly depending on whether you are updating one instance or several.

### Implement delete()

As with `update()`, `delete()` receives a `Uri` representing the instance or collection to work with and a `WHERE` clause and parameters. If the activity is deleting a single instance, the `Uri` should represent that instance and the `WHERE` clause may be null. But, the activity might be requesting to delete an open-ended set of instances, using the `WHERE` clause to constrain which ones to delete.

As with `update()`, though, this is simple if you are using `SQLite` for database storage (sense a theme?). You can let it handle the idiosyncrasies of parsing and applying the `WHERE` clause — all you have to do is call `delete()` on the database.

### Implement getType()

The last method you need to implement is `getType()`. This takes a `Uri` and returns the MIME type associated with that `Uri`. The `Uri` could be a collection or an instance `Uri`; you need to determine which was provided and return the corresponding MIME type.

### Update the Manifest

The glue tying the content provider implementation to the rest of your application resides in your `AndroidManifest.xml` file. Simply add a `<provider>` element as a child of the `<application>` element, such as:

## CONTENT PROVIDER THEORY

---

```
<?xml version="1.0" encoding="utf-8"?>
<manifest xmlns:android="http://schemas.android.com/apk/res/android"
    package="com.commonware.android.constants">

    <supports-screens
        android:anyDensity="true"
        android:largeScreens="true"
        android:normalScreens="true"
        android:smallScreens="true"/>

    <uses-sdk
        android:minSdkVersion="7"
        android:targetSdkVersion="11"/>

    <application
        android:icon="@drawable/ic_launcher"
        android:label="@string/app_name">
        <provider
            android:name=".Provider"
            android:authorities="com.commonware.android.constants.Provider"
            android:exported="false"/>

        <activity
            android:name=".ConstantsBrowser"
            android:label="@string/app_name">
            <intent-filter>
                <action android:name="android.intent.action.MAIN"/>

                <category android:name="android.intent.category.LAUNCHER"/>
            </intent-filter>
        </activity>
    </application>
</manifest>
```

The `android:name` property is the name of the content provider class, with a leading dot to indicate it is in the stock namespace for this application's classes (just like you use with activities).

The `android:authorities` property should be a semicolon-delimited list of the authority values supported by the content provider. Recall, from earlier in this chapter, that each content `Uri` is made up of a scheme, authority, data type path, and instance identifier. Each authority from each `CONTENT_URI` value should be included in the `android:authorities` list.

Now, when Android encounters a content `Uri`, it can sift through the providers registered through manifests to find a matching authority. That tells Android which application and class implements the content provider, and from there Android can bridge between the calling activity and the content provider being called.

### Add Notify-On-Change Support

A feature that your content provider can offer to its clients is notify-on-change support. This means that your content provider will let clients know if the data for a given content `Uri` changes.

For example, suppose you have created a content provider that retrieves RSS and Atom feeds from the Internet based on the user's feed subscriptions (via OPML, perhaps). The content provider offers read-only access to the contents of the feeds, with an eye towards several applications on the phone using those feeds versus everyone implementing their own feed poll-fetch-and-cache system. You have also implemented a service that will get updates to those feeds asynchronously, updating the underlying data store. Your content provider could alert applications using the feeds that such-and-so feed was updated, so applications using that specific feed can refresh and get the latest data.

On the content provider side, to do this, call `notifyChange()` on your `ContentResolver` instance (available in your content provider via `getContext().getContentResolver()`). This takes two parameters: the `Uri` of the piece of content that changed and the `ContentObserver` that initiated the change. In many cases, the latter will be `null`; a non-`null` value simply means that the observer that initiated the change will not be notified of its own changes.

On the content consumer side, an activity can call `registerContentObserver()` on its `ContentResolver` (via `getContentResolver()`). This ties a `ContentObserver` instance to a supplied `Uri` — the observer will be notified whenever `notifyChange()` is called for that specific `Uri`. When the consumer is done with the `Uri`, `unregisterContentObserver()` releases the connection.

### Implementing the File System-Style API

If you want consumers of your `ContentProvider` to be able to call `openInputStream()` or `openOutputStream()` on a `Uri`, you will need to implement the `openFile()` method. This method is optional — if you are not supporting `openInputStream()` or `openOutputStream()`, you do not need to implement `openFile()` at all.

The `openFile()` method returns a curious object called a `ParcelFileDescriptor`. Given that, the `ContentResolver` can obtain the `InputStream` or `OutputStream` that was requested. There are various static methods on `ParcelFileDescriptor` to create instances of it, such as an `open()` method that takes a `File` object as the first

parameter. Note that this works for both files on external storage and files within your own project's app-local file storage (e.g., `getFilesDir()`).

Note that you are welcome to also implement `onCreate()`, if you wish to do some initialization when the content provider starts up. Also, you will have to provide do-nothing implementations of `query()`, `insert()`, `update()`, and `delete()`, as those methods are mandatory in `ContentProvider` subclasses, even if you do not plan to support them.

## Issues with Content Providers

Content providers are not without their issues.

The biggest complaint seems to be the lack of an `onDestroy()` companion to the `onCreate()` method you can implement. Hence, if you open a database in `onCreate()`, you close it... never. Sometimes, you can alleviate this by initializing things on demand and releasing them immediately, such as opening a database as part of `insert()` and closing it within the same method. This does not always work, however — for example, you cannot close the database you query in `query()`, since the `Cursor` you return would become invalid.

The fact that `ContentProvider` is effectively a facade means that a consumer of a `ContentProvider` has no idea what to expect. It is up to documentation to explain what `Uri` values can be used, what columns can be returned, what query syntax is supported, and so on. And, the fact that it is a facade means that much of the richness of the SQLite interface is lost, such as `GROUP BY`. To top it off, the API supported by `ContentProvider` is rather limited — if what you want to share does not look like a database and does not look like a file, it may be difficult to force it into the `ContentProvider` API.

However, perhaps the biggest problem is that, by default, content providers are exported, meaning they can be accessed by other processes (third party applications or the Android OS). Sometimes this is desired. Sometimes, it is not. You need to set `android:exported` to be `false` on your manifest entry for the content provider if you want to keep the provider private to your application. This is the inverse of all other components, which are private by default, unless they have an `<intent-filter>`. Note that API Level 17 changes the default — if your `android:targetSdkVersion` is set to 17 or higher, `android:exported` is `false` by default, not `true` as before.

# Content Provider Implementation Patterns

---

[The previous chapter](#) focused on the concepts, classes, and methods behind content providers. This chapter more closely examines some implementations of content providers, organized into simple patterns.

## Prerequisites

Understanding this chapter requires that you have read [the preceding chapter](#).

## The Single-Table Database-Backed Content Provider

The simplest database-backed content provider is one that only attempts to expose a single table's worth of data to consumers. The CallLog content provider works this way, for example.

### Step #1: Create a Provider Class

We start off with a custom subclass of `ContentProvider`, named, cunningly enough, `Provider`. Here we need the database-style API methods: `query()`, `insert()`, `update()`, `delete()`, and `getType()`.

## CONTENT PROVIDER IMPLEMENTATION PATTERNS

---

### onCreate()

Here is the onCreate() method for Provider, from the [ContentProvider/ConstantsPlus](#) sample application:

```
@Override
public boolean onCreate() {
    db=new DatabaseHelper(getContext());

    return((db == null) ? false : true);
}
```

While that does not seem all that special, the “magic” is in the private DatabaseHelper object, a fairly conventional SQLiteOpenHelper implementation:

```
package com.commonware.android.constants;

import android.content.ContentValues;
import android.content.Context;
import android.database.Cursor;
import android.database.sqlite.SQLiteOpenHelper;
import android.database.sqlite.SQLiteDatabase;
import android.hardware.SensorManager;

class DatabaseHelper extends SQLiteOpenHelper {
    private static final String DATABASE_NAME="constants.db";

    public DatabaseHelper(Context context) {
        super(context, DATABASE_NAME, null, 1);
    }

    @Override
    public void onCreate(SQLiteDatabase db) {
        Cursor c=db.rawQuery("SELECT name FROM sqlite_master WHERE type='table' AND name='constants'", null);

        try {
            if (c.getCount()==0) {
                db.execSQL("CREATE TABLE constants (_id INTEGER PRIMARY KEY AUTOINCREMENT, title TEXT, value REAL);");

                ContentValues cv=new ContentValues();

                cv.put(Provider.Constants.TITLE, "Gravity, Death Star I");
                cv.put(Provider.Constants.VALUE, SensorManager.GRAVITY_DEATH_STAR_I);
                db.insert("constants", Provider.Constants.TITLE, cv);

                cv.put(Provider.Constants.TITLE, "Gravity, Earth");
                cv.put(Provider.Constants.VALUE, SensorManager.GRAVITY_EARTH);
                db.insert("constants", Provider.Constants.TITLE, cv);
            }
        }
    }
}
```

## CONTENT PROVIDER IMPLEMENTATION PATTERNS

---

```
cv.put(Provider.Constants.TITLE, "Gravity, Jupiter");
cv.put(Provider.Constants.VALUE, SensorManager.GRAVITY_JUPITER);
db.insert("constants", Provider.Constants.TITLE, cv);

cv.put(Provider.Constants.TITLE, "Gravity, Mars");
cv.put(Provider.Constants.VALUE, SensorManager.GRAVITY_MARS);
db.insert("constants", Provider.Constants.TITLE, cv);

cv.put(Provider.Constants.TITLE, "Gravity, Mercury");
cv.put(Provider.Constants.VALUE, SensorManager.GRAVITY_MERCURY);
db.insert("constants", Provider.Constants.TITLE, cv);

cv.put(Provider.Constants.TITLE, "Gravity, Moon");
cv.put(Provider.Constants.VALUE, SensorManager.GRAVITY_MOON);
db.insert("constants", Provider.Constants.TITLE, cv);

cv.put(Provider.Constants.TITLE, "Gravity, Neptune");
cv.put(Provider.Constants.VALUE, SensorManager.GRAVITY_NEPTUNE);
db.insert("constants", Provider.Constants.TITLE, cv);

cv.put(Provider.Constants.TITLE, "Gravity, Pluto");
cv.put(Provider.Constants.VALUE, SensorManager.GRAVITY_PLUTO);
db.insert("constants", Provider.Constants.TITLE, cv);

cv.put(Provider.Constants.TITLE, "Gravity, Saturn");
cv.put(Provider.Constants.VALUE, SensorManager.GRAVITY_SATURN);
db.insert("constants", Provider.Constants.TITLE, cv);

cv.put(Provider.Constants.TITLE, "Gravity, Sun");
cv.put(Provider.Constants.VALUE, SensorManager.GRAVITY_SUN);
db.insert("constants", Provider.Constants.TITLE, cv);

cv.put(Provider.Constants.TITLE, "Gravity, The Island");
cv.put(Provider.Constants.VALUE, SensorManager.GRAVITY_THE_ISLAND);
db.insert("constants", Provider.Constants.TITLE, cv);

cv.put(Provider.Constants.TITLE, "Gravity, Uranus");
cv.put(Provider.Constants.VALUE, SensorManager.GRAVITY_URANUS);
db.insert("constants", Provider.Constants.TITLE, cv);

cv.put(Provider.Constants.TITLE, "Gravity, Venus");
cv.put(Provider.Constants.VALUE, SensorManager.GRAVITY_VENUS);
db.insert("constants", Provider.Constants.TITLE, cv);
}
}
finally {
    c.close();
}
}

@Override
public void onUpgrade(SQLiteDatabase db, int oldVersion, int newVersion) {
    android.util.Log.w("Constants", "Upgrading database, which will destroy all
old data");
```



## CONTENT PROVIDER IMPLEMENTATION PATTERNS

---

```
        db.execSQL("DROP TABLE IF EXISTS constants");
        onCreate(db);
    }
}
```

Note that we are creating the DatabaseHelper in onCreate() and are never closing it. That is because there is no onDestroy() (or equivalent) method in a ContentProvider. While we might be tempted to open and close the database on every operation, that will not work, as we cannot close the database and still hand back a live Cursor from the database. Hence, we leave it open and assume that SQLite's transactional nature will ensure that our database is not corrupted when Android shuts down the ContentProvider.

### query()

For SQLite-backed storage providers like this one, the query() method implementation should be largely boilerplate. Use a SQLiteQueryBuilder to convert the various parameters into a single SQL statement, then use query() on the builder to actually invoke the query and give you a Cursor back. The Cursor is what your query() method then returns.

For example, here is query() from Provider:

```
@Override
public Cursor query(Uri url, String[] projection, String selection,
                   String[] selectionArgs, String sort) {
    SQLiteQueryBuilder qb=new SQLiteQueryBuilder();

    qb.setTables(TABLE);

    String orderBy;

    if (TextUtils.isEmpty(sort)) {
        orderBy=Constants.DEFAULT_SORT_ORDER;
    }
    else {
        orderBy=sort;
    }

    Cursor c=
        qb.query(db.getReadableDatabase(), projection, selection,
                selectionArgs, null, null, orderBy);

    c.setNotificationUri(getContext().getContentResolver(), url);

    return(c);
}
```

## CONTENT PROVIDER IMPLEMENTATION PATTERNS

---

We create a `SQLiteQueryBuilder` and pour the query details into the builder, notably the name of the table that we query against and the sort order (substituting in a default sort if the caller did not request one). When done, we use the `query()` method on the builder to get a `Cursor` for the results. We also tell the resulting `Cursor` what `Uri` was used to create it, for use with the content observer system.

The `query()` implementation, like many of the other methods on `Provider`, delegates much of the `Provider`-specific information to private methods, such as:

1. the name of the table (`getTableName()`)
2. the default sort order (`getDefaultSortOrder()`)

### **insert()**

Since this is a `SQLite`-backed content provider, once again, the implementation is mostly boilerplate: validate that all required values were supplied by the activity, merge your own notion of default values with the supplied data, and call `insert()` on the database to actually create the instance.

For example, here is `insert()` from `Provider`:

```
@Override
public Uri insert(Uri url, ContentValues initialValues) {
    long rowID=
        db.getWritableDatabase().insert(TABLE, Constants.TITLE,
                                       initialValues);

    if (rowID > 0) {
        Uri uri=
            ContentUris.withAppendedId(Provider.Constants.CONTENT_URI,
                                       rowID);
        getContext().getContentResolver().notifyChange(uri, null);

        return(uri);
    }

    throw new SQLException("Failed to insert row into " + url);
}
```

The pattern is the same as before: use the provider particulars plus the data to be inserted to actually do the insertion.

### **update()**

Here is `update()` from `Provider`:

## CONTENT PROVIDER IMPLEMENTATION PATTERNS

---

```
@Override
public int update(Uri url, ContentValues values, String where,
                  String[] whereArgs) {
    int count=
        db.getWritableDatabase()
            .update(TABLE, values, where, whereArgs);

    getContext().getContentResolver().notifyChange(url, null);

    return(count);
}
```

In this case, updates are always applied across the entire collection, though we could have a smarter implementation that supported updating a single instance via an instance Uri.

### **delete()**

Similarly, here is delete() from Provider:

```
@Override
public int delete(Uri url, String where, String[] whereArgs) {
    int count=db.getWritableDatabase().delete(TABLE, where, whereArgs);

    getContext().getContentResolver().notifyChange(url, null);

    return(count);
}
```

This is almost a clone of the update() implementation described above.

### **getType()**

The last method you need to implement is getType(). This takes a Uri and returns the MIME type associated with that Uri. The Uri could be a collection or an instance Uri; you need to determine which was provided and return the corresponding MIME type.

For example, here is getType() from Provider:

```
@Override
public String getType(Uri url) {
    if (isCollectionUri(url)) {
        return("vnd.commonware.cursor.dir/constant");
    }
}
```

```
return("vnd.commonware.cursor.item/constant");  
}
```

### Step #2: Supply a Uri

You may wish to add a public static member... somewhere, containing the `Uri` for each collection your content provider supports, for use by your own application code. Typically, this is a public static final `Uri` put on the content provider class itself:

```
public static final Uri CONTENT_URI=  
    Uri.parse("content://com.commonware.android.constants.Provider/  
constants");
```

You may wish to use the same namespace for the content `Uri` that you use for your Java classes, to reduce the chance of collision with others.

Bear in mind that if you intend for third parties to access your content provider, they will not have access to this public static data member, as your class is not in their project. Hence, you will need to publish the string representation of this `Uri` that they can hard-wire into their application.

### Step #3: Declare the “Columns”

Remember those “columns” you referenced when you were using a content provider, [in the previous chapter](#)? Well, you may wish to publish public static values for those too for your own content provider.

Specifically, you may want a public static class implementing `BaseColumns` that contains your available column names, such as this example from `Provider`:

```
public static final class Constants implements BaseColumns {  
    public static final Uri CONTENT_URI=  
        Uri.parse("content://com.commonware.android.constants.Provider/  
constants");  
    public static final String DEFAULT_SORT_ORDER="title";  
    public static final String TITLE="title";  
    public static final String VALUE="value";  
}
```

Since we are using `SQLite` as a data store, the values for the column name constants should be the corresponding column name in the table, so you can just pass the projection (array of columns) to `SQLite` on a `query()`, or pass the `ContentValues` on an `insert()` or `update()`.

Note that nothing in here stipulates the types of the properties. They could be strings, integers, or whatever. The biggest limitation is what a Cursor can provide access to via its property getters. The fact that there is nothing in code that enforces type safety means you should document the property types well, so people attempting to use your content provider know what they can expect.

### Step #4: Update the Manifest

Finally, we need to add the provider to the `AndroidManifest.xml` file, by adding a `<provider>` element as a child of the `<application>` element:

```
<?xml version="1.0" encoding="utf-8"?>
<manifest xmlns:android="http://schemas.android.com/apk/res/android"
    package="com.commonware.android.constants">

    <supports-screens
        android:anyDensity="true"
        android:largeScreens="true"
        android:normalScreens="true"
        android:smallScreens="true"/>

    <uses-sdk
        android:minSdkVersion="7"
        android:targetSdkVersion="11"/>

    <application
        android:icon="@drawable/ic_launcher"
        android:label="@string/app_name">
        <provider
            android:name=".Provider"
            android:authorities="com.commonware.android.constants.Provider"
            android:exported="false"/>

        <activity
            android:name=".ConstantsBrowser"
            android:label="@string/app_name">
            <intent-filter>
                <action android:name="android.intent.action.MAIN"/>

                <category android:name="android.intent.category.LAUNCHER"/>
            </intent-filter>
        </activity>
    </application>
</manifest>
```

## The Local-File Content Provider

Implementing a content provider that supports serving up files based on `Uri` values is similar, and generally simpler, than creating a content provider for the database-style API. In this section, we will examine the [ContentProvider/Files](#) sample project. This project demonstrates a common use of the filesystem-style API: serving files from internal storage to third-party applications (who, by default, cannot read your internally-stored files).

Note that this sample project will only work on devices that have an application capable of viewing PDF files accessed via `content://Uri` values.

### Step #1: Create the Provider Class

Once again, we create a subclass of `ContentProvider`. This time, though, the roster of methods we need to worry about is a bit different.

#### `onCreate()`

We have an `onCreate()` method. In many cases, this would not be needed for this sort of provider. After all, there is no database to open. In this case, we use `onCreate()` to copy the file(s) out of assets into the app-local file store. In principle, this would allow our application code to modify these files as the user uses the app (versus the unmodifiable editions in `assets/`).

```
@Override
public boolean onCreate() {
    File f=new File(getContext().getFilesDir(), "test.pdf");

    if (!f.exists()) {
        AssetManager assets=getContext().getResources().getAssets();

        try {
            copy(assets.open("test.pdf"), f);
        }
        catch (IOException e) {
            Log.e("FileProvider", "Exception copying from assets", e);

            return(false);
        }
    }

    return(true);
}
```

## CONTENT PROVIDER IMPLEMENTATION PATTERNS

---

This uses a private `copy()` method that can copy an `InputStream` from an asset to a local `File`:

```
}

static private void copy(InputStream in, File dst) throws IOException {
    FileOutputStream out=new FileOutputStream(dst);
    byte[] buf=new byte[1024];
    int len;

    while ((len=in.read(buf)) > 0) {
        out.write(buf, 0, len);
    }

    in.close();
}
```

### **openFile()**

We need to implement `openFile()`, to return a `ParcelFileDescriptor` corresponding to the supplied `Uri`:

```
@Override
public ParcelFileDescriptor openFile(Uri uri, String mode)
                                                                    throws
FileNotFoundException {
    File f=new File(getContext().getFilesDir(), uri.getPath());

    if (f.exists()) {
        return(ParcelFileDescriptor.open(f,
                                        ParcelFileDescriptor.MODE_READ_ONLY));
    }

    throw new FileNotFoundException(uri.getPath());
}
```

Here, we ignore the supplied mode parameter, treating this as a read-only file. That is safe in this case, since our only planned use of the provider is to serve read-only content to a `WebView` widget. If we wanted read-write access, we would need to convert the mode to something usable by the `open()` method on `ParcelFileDescriptor`.

### **getType()**

We need to implement `getType()`, in this case using real MIME types, not made-up ones. To do that, we have a static `HashMap` mapping file extensions to MIME types:

```
static {
    MIME_TYPES.put(".pdf", "application/pdf");
}
```

## CONTENT PROVIDER IMPLEMENTATION PATTERNS

---

Then, `getType()` walks those to find a match and uses that particular MIME type:

```
@Override
public String getType(Uri uri) {
    String path=uri.toString();

    for (String extension : MIME_TYPES.keySet()) {
        if (path.endsWith(extension)) {
            return(MIME_TYPES.get(extension));
        }
    }

    return(null);
}
```

### All Those Other Ones

In theory, that would be all we need. In practice, other methods are abstract on `ContentProvider` and need stub implementations:

```
@Override
public Cursor query(Uri url, String[] projection, String selection,
    String[] selectionArgs, String sort) {
    throw new RuntimeException("Operation not supported");
}

@Override
public Uri insert(Uri uri, ContentValues initialValues) {
    throw new RuntimeException("Operation not supported");
}

@Override
public int update(Uri uri, ContentValues values, String where,
    String[] whereArgs) {
    throw new RuntimeException("Operation not supported");
}

@Override
public int delete(Uri uri, String where, String[] whereArgs) {
```

Here, we throw a `RuntimeException` if any of those methods are called, indicating that our content provider does not support them.

### Step #2: Update the Manifest

Finally, we need to add the provider to the `AndroidManifest.xml` file, by adding a `<provider>` element as a child of the `<application>` element, as with any other content provider:



## CONTENT PROVIDER IMPLEMENTATION PATTERNS

---

```
<?xml version="1.0" encoding="utf-8"?>
<manifest xmlns:android="http://schemas.android.com/apk/res/android"
    package="com.commonware.android.cp.files"
    android:versionCode="1"
    android:versionName="1.0">

    <uses-sdk
        android:minSdkVersion="7"
        android:targetSdkVersion="11"/>

    <supports-screens
        android:largeScreens="true"
        android:normalScreens="true"
        android:smallScreens="true"/>

    <application
        android:icon="@drawable/ic_launcher"
        android:label="@string/app_name">
        <activity
            android:name="FilesCPDemo"
            android:label="@string/app_name"
            android:theme="@android:style/Theme.NoDisplay">
            <intent-filter>
                <action android:name="android.intent.action.MAIN"/>

                <category android:name="android.intent.category.LAUNCHER"/>
            </intent-filter>
        </activity>

        <provider
            android:name=".FileProvider"
            android:authorities="com.commonware.android.cp.files"
            android:exported="true"/>
    </application>
</manifest>
```

Note, however, that we have `android:exported="true"` set in our `<provider>` element. This means that this content provider can be accessed from third-party apps or other external processes (e.g., the media framework for playing back videos).

### Using this Provider

The activity is fairly trivial, simply creating an `ACTION_VIEW` Intent on our PDF file and starting up an activity for it, then finishing itself:

```
package com.commonware.android.cp.files;

import android.app.Activity;
import android.content.Intent;
import android.net.Uri;
```

```
import android.os.Bundle;

public class FilesCPDemo extends Activity {
    @Override
    public void onCreate(Bundle icle) {
        super.onCreate(icle);

        startActivity(new Intent(Intent.ACTION_VIEW,
                                Uri.parse(FileProvider.CONTENT_URI
                                    + "test.pdf")));
        finish();
    }
}
```

Here, we use a `CONTENT_URI` published by `FileProvider` as the basis for identifying the file:

```
Uri.parse("content://com.commonsware.android.cp.files/");
```

## The Stream Provider

Sometimes, we want a provider that looks like the local-file provider from the preceding section... but we do not have a file. Instead, we have data in some other form, such as a byte array, or a `String`, or an `InputStream`. Writing that material to a file may be problematic, or even counterproductive.

For example, imagine an app that stores data on the user's behalf in an encrypted fashion. One such file is a PDF, that the user would like to view. There are PDF viewers that can view files served via `content://Uri` values, as the previous section demonstrated... but that assumes an unencrypted file. While we could decrypt the file, writing the decrypted results to another file, and serve the decrypted data to the PDF viewer, now we have a persistent decrypted version of the data. That opens a window of time when the data might be accessed by people with nefarious intent, which is something we are trying to avoid by using the encrypted store in the first place. Rather, it would be nice if we could decrypt the data *on the fly* and give that decrypted result to the PDF viewer. Of course, there are security risks intrinsic to that too — after all, we do not know what the PDF viewer might do with the unencrypted data — but it is at least an improvement.

The good news is that Android does support streaming options for `openFile()`-style `ContentProvider` implementations. However, as one might expect, they are not the simplest things to implement.

In this section, we will examine the `ContentProvider/Pipe` (<http://github.com/commonsguy/cw-omnibus/tree/master/ContentProvider/Pipe>) sample project. This is a near clone of the `ContentProvider/Files` sample from the preceding section. However, rather than simply handing the file to Android to serve as content, we will stream it in ourselves. In principle, as part of this streaming, we could be decrypting it from an encrypted state. Since this sample shares much code with the previous sample, we will focus solely on the changes here.

Note that this sample was inspired by the sample found at <https://github.com/nandeeshwar/Pfd-Create-Pipe>.

### The Pipes

Starting with API Level 9, it is possible to create a pipe between two processes, from the Android SDK, via `ParcelFileDescriptor`. In the previous section, we saw how `ParcelFileDescriptor` could be used to open a local file and make that available to other processes — the `createPipe()` method gives us a pipe.

The “pipe” returned by `createPipe()` is a two-element array of `ParcelFileDescriptor` objects. The first element in the array represents the “read” end of the pipe. In our case, that is the end that should be used by a PDF viewer to read in the file contents. The second element of the array represents the “write” end of the pipe, which we will use to supply the file’s contents to the “read” end (and to the PDF viewer by extension).

### The Revised `openFile()`

With that in mind, here is our revised `openFile()` method:

```
@Override
public ParcelFileDescriptor openFile(Uri uri, String mode)
                                                                    throws
FileNotFoundException {
    ParcelFileDescriptor[] pipe=null;

    try {
        pipe=ParcelFileDescriptor.createPipe();
        AssetManager assets=getContext().getResources().getAssets();

        new TransferThread(assets.open(uri.getLastPathSegment()),
                           new AutoCloseOutputStream(pipe[1])).start();
    }
    catch (IOException e) {
        Log.e(getClass().getSimpleName(), "Exception opening pipe", e);
    }
}
```

## CONTENT PROVIDER IMPLEMENTATION PATTERNS

---

```
        throw new FileNotFoundException("Could not open pipe for: "
            + uri.toString());
    }

    return(pipe[0]);
}
```

We create our pipe via `createPipe()`, then get an `InputStream` on our PDF file stored as an asset — unlike the `ContentProvider/Files` sample, we do not need to copy the asset to a local file now. We then kick off a background thread, implemented in an inner class named `TransferThread`, to actually copy the data from the asset to the write end of the pipe.

Rather than supply `TransferThread` with a `ParcelFileDescriptor` for the write end of the pipe, we supply an `OutputStream`. Specifically, we pass in a `ParcelFileDescriptor.AutoCloseOutputStream`. This is an `OutputStream` that knows to close the `ParcelFileDescriptor` when we close the stream. Otherwise, it behaves like a fairly typical `OutputStream`.

### The Transfer

`TransferThread` is a fairly conventional copy-data-from-stream-to-stream implementation:

```
static class TransferThread extends Thread {
    InputStream in;
    OutputStream out;

    TransferThread(InputStream in, OutputStream out) {
        this.in=in;
        this.out=out;
    }

    @Override
    public void run() {
        byte[] buf=new byte[1024];
        int len;

        try {
            while ((len=in.read(buf)) > 0) {
                out.write(buf, 0, len);
            }

            in.close();
            out.flush();
            out.close();
        }
        catch (IOException e) {
```

```
        Log.e(getClass().getSimpleName(),  
            "Exception transferring file", e);  
    }  
}
```

Here, we read in data in 1KB blocks from the `InputStream` (our asset) and write the data to our `OutputStream` (obtained from the `ParcelFileDescriptor`).

### The Results

Our activity logic has not substantially changed. We still create an `ACTION_VIEW` Intent on the `content://Uri` from our provider, pointing to our `test.pdf` asset. Any PDF viewer capable of handling `content://Uri` values will use a `ContentResolver` to open an `InputStream` for our `Uri`. In the `ContentProvider/Files` sample, that `InputStream` would receive the contents of the file directly from Android. In this new sample, that `InputStream` is reading in bytes off of our pipe, until such time as it has read in all the streamed data and we have closed the `OutputStream`.

Not every possible consumer of a `Uri` will be able to work with our stream, though. For example, `MediaPlayer` expects to be able to determine, up front, how big the file is, and while that works for file-backed `ParcelFileDescriptors`, it does not work for those representing a pipe. Hence, `MediaPlayer` will crash when trying to use a `Uri` to a pipe-based stream, which is certainly unfortunate.

The author would like to thank Reuben Scratton for his assistance in [tracking down this MediaPlayer limitation](#).

# The Loader Framework

---

One perpetual problem in Android development is getting work to run outside the main application thread. Every millisecond we spend on the main application thread is a millisecond that our UI is frozen and unresponsive. Disk I/O, in particular, is a common source of such slowdowns, particularly since this is one place where the emulator typically out-performs actual devices. While disk operations rarely get to the level of causing an “application not responding” (ANR) dialog to appear, they can make a UI “janky”.

Android 3.0 introduced a new framework to help deal with loading bulk data off of disk, called “loaders”. The hope is that developers can use loaders to move database queries and similar operations into the background and off the main application thread. That being said, loaders themselves have issues, not the least of which is the fact that it is new to Android 3.0 and therefore presents some surmountable challenges for use in older Android devices.

This chapter will outline the programming pattern loaders are designed to solve, how to use loaders (both built-in and third-party ones) in your activities, and how to create your own loaders for scenarios not already covered.

## Prerequisites

Understanding this chapter requires that you have read the chapters on:

- [database access](#)
- [content provider theory](#)
- [content provider implementations](#)

## Cursors: Issues with Management

Android has had the concept of “managed cursors” since Android 1.0, and perhaps before that. A managed Cursor is one that an Activity... well... manages. More specifically:

1. When the activity is stopped, the managed Cursor is deactivated, freeing up all of the memory associated with the result set, and thereby reducing the activity’s heap footprint while it is not in the foreground
2. When the activity is restarted, the managed Cursor is requeryed, to bring back the deactivated data, along the way incorporating any changes in that data that may have occurred while the activity was off-screen
3. When the activity is destroyed, the managed Cursor is closed.

This is a delightful set of functionality. Cursor objects obtained from a ContentProvider via `managedQuery()` are automatically managed; a Cursor from SQLiteDatabase can be managed by `startManagingCursor()`.

The problem is that the `requery()` operation that is performed when the activity is restarted is executed on the main application thread. Many times, this is not a huge deal. However, given the nature of on-device flash and the Linux filesystem that many Android devices use (YAFFS2), it is entirely possible that what ordinarily is quick sometimes will not be. Also, you might be testing with small data sets, and your users might be working with bigger ones. As a result, the `requery()` may slow down your UI in ways that the user will notice.

## Introducing the Loader Framework

The Loader framework was designed to solve three issues with the old managed Cursor implementation:

- Arranging for a `requery()` (or the equivalent) to be performed on a background thread)
- Arranging for the original query that populated the data in the first place to also be performed on a background thread, which the managed Cursor solution did not address at all
- Supporting loading things other than a Cursor, in case you have data from other sources (e.g., XML files, JSON files, Web service calls) that might be able to take advantage of the same capabilities as you can get from a Cursor via the loaders

There are three major pieces to the Loader framework: LoaderManager, LoaderCallbacks, and the Loader itself.

### LoaderManager

LoaderManager is your gateway to the Loader framework. You obtain one by calling `getLoaderManager()` (or `getSupportLoaderManager()`, as is described [later in this chapter](#)). Via the LoaderManager you can initialize a Loader, restart that Loader (e.g., if you have a different query to use for loading the data), etc.

### LoaderCallbacks

Much of your interaction with the Loader, though, comes from your LoaderCallbacks object, such as your activity if that is where you elect to implement the LoaderCallbacks interface. Here, you will implement three “lifecycle” methods for consuming a Loader:

1. `onCreateLoader()` is called when your activity requests that a LoaderManager initialize a Loader. Here, you will create the instance of the Loader itself, teaching it whatever it needs to know to go load your data
2. `onLoadFinished()` is called when the Loader has actually loaded the data — you can take those results and pour them into your UI, such as calling `swapCursor()` on a CursorAdapter to supply the fresh Cursor’s worth of data
3. `onLoaderReset()` is called when you should stop using the data supplied to you in the last `onLoadFinished()` call (e.g., the Cursor is going to be closed), so you can arrange to make that happen (e.g., call `swapCursor(null)` on a CursorAdapter)

When you implement the LoaderCallbacks interface, you will need to provide the data type of whatever it is that your Loader is loading (e.g., `LoaderCallbacks<Cursor>`). If you have several loaders returning different data types, you may wish to consider implementing LoaderCallbacks on multiple objects (e.g., instances of anonymous inner classes), so you can take advantage of the type safety offered by Java generics, rather than implementing `LoaderCallbacks<Object>` or something to that effect.

### Loader

Then, of course, there is Loader itself.



Consumers of the Loader framework will use some concrete implementation of the abstract Loader class in their LoaderCallbacks onCreateLoader() method. API Level 11 introduced only one concrete implementation: CursorLoader, designed to perform queries on a ContentProvider, and described in [a later section](#). This chapter will also outline the use of [another concrete implementation](#), SQLiteCursorLoader, available via a JAR.

You are also welcome to create your own Loader implementations, if your data source is not a ContentResolver or SQLiteDatabase, and even if your data model is not a Cursor. You will typically extend AsyncTaskLoader, which arranges for the actual loading work to be done on a background thread. This chapter will [delve into the implementation](#) of SQLiteCursorLoader so you can see what the key methods are that you will need to implement.

## Honeycomb... Or Not

Loader and its related classes were introduced in Android 3.0 (API Level 11). If your application is only going to be deployed on such devices, you can use loaders “naturally” via the standard implementation.

If, however, you are interested in using loaders but also want to support pre-Honeycomb devices, the Android Support package offers its own implementation of Loader and the other classes. However, to use it, you will need to work within four constraints:

- You will need to add the Android Support package’s JAR to your project (e.g., copy the JAR into your libs/ directory and add it to your build path)
- You will need to inherit from FragmentActivity, not the OS base Activity class or other refinements (e.g., MapActivity), or from other classes that inherit from FragmentActivity (e.g., SherlockFragmentActivity).
- You will need to import the support.v4 versions of various classes (e.g., android.support.v4.app.LoaderManager instead of android.app.LoaderManager)
- You will need to get your LoaderManager by calling getSupportLoaderManager(), instead of getLoaderManager(), on your FragmentActivity

These limitations are the same ones that you will encounter when using fragments on older devices. Hence, while loaders and fragments are not really related, you may

find yourself adopting both of them at the same time, as part of incorporating the Android Support package into your project.

## Using CursorLoader

Let's start off by examining the simplest case: using a `CursorLoader` to asynchronously populate and update a `Cursor` retrieved from a `ContentProvider`. This is illustrated in the [Loaders/ConstantsLoader](#) sample project, which is the same show-the-list-of-gravity-constants sample application that [we examined previously](#), updated to use the Loader framework. Note that this project does not use the Android Support package and therefore only supports API Level 11 and higher.

In `onCreate()`, rather than executing a `managedQuery()` to retrieve our constants, we ask our `LoaderManager` to initialize a loader, after setting up our `SimpleCursorAdapter` on a null `Cursor`:

```
@Override
public void onCreate(Bundle savedInstanceState) {
    super.onCreate(savedInstanceState);

    adapter=new SimpleCursorAdapter(this,
        R.layout.row, null,
        new String[] {Provider.Constants.TITLE,
            Provider.Constants.VALUE},
        new int[] {R.id.title, R.id.value});

    setListAdapter(adapter);
    registerForContextMenu(getListView());
    getLoaderManager().initLoader(0, null, this);
}
```

Using a null `Cursor` means we will have an empty list at the outset, a problem we will rectify shortly.

The `initLoader()` call on `LoaderManager` (retrieved via `getLoaderManager()`) takes three parameters:

- A locally-unique identifier for this loader
- An optional `Bundle` of data to supply to the loader
- A `LoaderCallbacks` implementation to use for the results from this loader (here set to be the activity itself, as it implements the `LoaderManager.LoaderCallbacks<Cursor>` interface)

## THE LOADER FRAMEWORK

---

The first time you call this for a given identifier, your `onCreateLoader()` method of the `LoaderCallbacks` will be called. Here, you need to initialize the `Loader` to use for this identifier. You are passed the identifier plus the `Bundle` (if any was supplied). In our case, we want to use a `CursorLoader`:

```
public Loader<Cursor> onCreateLoader(int loaderId, Bundle args) {
    return(new CursorLoader(this, Provider.Constants.CONTENT_URI,
        PROJECTION, null, null, null));
}
```

`CursorLoader` takes a `Context` plus all of the parameters you would ordinarily use with `managedQuery()`, such as the content provider `Uri`. Hence, converting existing code to use `CursorLoader` means converting your `managedQuery()` call into an invocation of the `CursorLoader` constructor inside of your `onCreateLoader()` method.

At this point, the `CursorLoader` will query the content provider, but do so on a background thread, so the main application thread is not tied up. When the `Cursor` has been retrieved, it is supplied to your `onLoadFinished()` method of your `LoaderCallbacks`:

```
public void onLoadFinished(Loader<Cursor> loader, Cursor cursor) {
    adapter.swapCursor(cursor);
}
```

Here, we call the new `swapCursor()` available on `CursorAdapter`, to replace the original `null` `Cursor` with the newly-loaded `Cursor`.

Your `onLoadFinished()` method will also be called whenever the data represented by your `Uri` changes. That is because the `CursorLoader` is registering a `ContentObserver`, so it will find out about data changes and will automatically requery the `Cursor` and supply you with the updated data.

Eventually, `onLoaderReset()` will be called. You are passed a `Cursor` object that you were supplied previously in `onLoadFinished()`. You need to make sure that you are no longer using that `Cursor` at this point — in our case, we swap `null` back into our `CursorAdapter`:

```
public void onLoaderReset(Loader<Cursor> loader) {
    adapter.swapCursor(null);
}
```

And that's pretty much it, at least for using `CursorLoader`. Of course, you need a content provider to make this work, and creating a content provider involves a bit of work.

## Using `SQLiteCursorLoader`

What happens if you do not have a content provider? What if you are just using `SQLiteDatabase`, perhaps via `SQLiteOpenHelper`?

There is nothing in the Android SDK directly designed to apply the Loader pattern to `SQLiteDatabase`. However, the author of this book has created his own `SQLiteCursorLoader`, as part of the LoaderEx CommonsWare Android Component open source project. The project has [a GitHub repository](#) with its own code, plus a demo/ sub-project illustrating its use. LoaderEx is licensed under the Apache Software License 2.0.

The nice thing about the Loader framework is that it isolates much of knowledge of what the specific Loader class is. Hence, using `SQLiteCursorLoader` is nearly identical to using `CursorLoader`. The primary difference is that you would create a `SQLiteCursorLoader` in your `onCreateLoader()` method, as shown in the following implementation from the ConstantsBrowser activity in the LoaderEx sample project:

```
public Loader<Cursor> onCreateLoader(int loaderId, Bundle args) {
    loader=
        new SQLiteCursorLoader(this, db, "SELECT _ID, title, value "
            + "FROM constants ORDER BY title", null);

    return(loader);
}
```

Just as the constructor for `CursorLoader` takes the same parameters as does `managedQuery()` (plus a `Context`), the constructor for `SQLiteCursorLoader` takes the same parameters as does `rawQuery()` on a `SQLiteDatabase` (plus the `SQLiteDatabase` object itself and a `Context`).

The other difference is that there is no automatic means for `SQLiteCursorLoader` to know that the data in the database has changed. If you modify the data in the activity (e.g., insert or delete a row), you can call `restartLoader()` on your `LoaderManager` to have it execute the query again. This will supply the modified `Cursor` to your `onLoadFinished()` method, where you can once again slide it into the `CursorAdapter`.

There are two flavors of the `SQLiteCursorLoader` class. One, in `com.commonware.cwac.loaderex`, is designed for use with API Level 11 and higher. The other, in `com.commonware.cwac.loaderex.ac1`, is designed for use with the Android Compatibility Library. If you use the JAR published in the downloads area of the GitHub repository, you can use either package. If you elect to add the project to yours as an Android library project, though, you will need to include the Android Support package's JAR in your build path, otherwise the `.ac1` edition of `SQLiteCursorLoader` will fail to compile, even if you are not planning on using it. Alternatively, you could get rid of the `com.commonware.cwac.loaderex.ac1` package entirely to avoid this dependency.

## Inside `SQLiteCursorLoader`

However, there may be times when you want to create your own custom Loader:

1. You want to load a `Cursor`, but you want to have greater control over what background thread is used
2. You want to load a `Cursor`, but not from a content provider and not from `SQLite` (e.g., a `MatrixCursor` you populate from other sources)
3. You want to load something that is not a `Cursor`

In this section, we will examine the implementation of `SQLiteCursorLoader`, so you get an idea of what will be required to make another type of Loader.

## `AbstractCursorLoader`

If you are creating your own Loader for reasons other than wanting to control the thread it loads on, the `AsyncTaskLoader` class supplied by Android (API Level 11 and Android Support package editions) is a likely class for you to extend. It handles the public Loader API and routes key logic to run on a background thread supplied by the ever-popular `AsyncTask`. By extending this class, you do not have to worry about the threading yourself, so you can focus more on your data-loading logic.

If you are creating a custom Loader that is loading a `Cursor`, just from an unusual source, you might consider extending `AbstractCursorLoader` instead. This class is in the `LoaderEx` project (API Level 11 and Android Support package editions). It consists mostly of the implementation of `CursorLoader` from the Android Support package, with the actual work to load the `Cursor` removed and replaced with a call to an abstract `buildCursor()` method. Since `AbstractCursorLoader` itself inherits from `AsyncTaskLoader`, the background thread is handled for you. We will examine an

implementation of `AbstractCursorLoader` — the `SQLiteCursorLoader` we saw [previously](#) – in [the next section](#). Here, though, we will look at the internals of `AbstractCursorLoader` itself, so you can see the sorts of things an `AsyncTaskLoader` needs to do.

### `loadInBackground()`

The `loadInBackground()` method, as the name suggests, is where you load your data, and it is called on the background thread from the `AsyncTask`.

The key is to make sure that you really do load the data. Sometimes that is obvious, sometimes it is not. For example, when you query a content provider or database, the `Cursor` may just be a stub, delaying the actual work until the first time you try using the `Cursor`. With that in mind, the `AbstractCursorLoader` implementation of `loadInBackground()` not only calls the abstract `buildCursor()` method, but it ensures the `Cursor` data is really loaded by finding out how many rows are in it:

```
@Override
public Cursor loadInBackground() {
    Cursor cursor=buildCursor();

    if (cursor!=null) {
        // Ensure the cursor window is filled
        cursor.getCount();
    }

    return(cursor);
}
```

### `deliverResult()`

This will be called, on the main application thread, when your `loadInBackground()` is complete and there are new results to be delivered to whoever is using this Loader. There are three main things you need to do here:

- Check to see if the Loader has been reset by calling `isReset()`. If the Loader was reset while `loadInBackground()` was doing its work, we no longer need the results (passed in as a parameter to `deliverResult()`), so you should free it up. In our case, we close the `Cursor`.
- Check to see if the Loader actually was started by calling `isStarted()`. If the Loader is started, chain to the superclass to actually hand the results back to the client.

- Manage any caching of the results, including releasing any previously-cached results that will no longer be used. In our case, we close the last `Cursor` we delivered and cache the new one.

### **onStartLoading()**

The `onStartLoading()` method is called, on the main application thread, when there has been a request to retrieve data from the `Loader`. If you have a cached result that is still valid, you can pass it to `deliverResult()` — if not, you should do something to start loading the data. In our case, if the data might have been changed or is not cached at all, we use `forceLoad()` to kick off the background thread and our `loadInBackground()` logic.

### **onCanceled()**

It is possible to try to cancel an outstanding load request, by calling `cancelLoad()` on the `AsyncTaskLoader`. This, in turn, will try to `cancel()` the `AsyncTask`. That will eventually route to a call to `onCanceled()` in your implementation of `AsyncTaskLoader`. In the case of `AbstractCursorLoader`, we ensure that the `Cursor` we are supplied is closed — this might occur, for example, if we tried to cancel the load but the load completed first.

```
* call to cancel(). Here, we make sure our Cursor
* is closed, if it still exists and is not already closed.
*/
@Override
public void onCanceled(Cursor cursor) {
    if (cursor!=null && !cursor.isClosed()) {
```

### **onStopLoading()**

More commonly, though, a `Loader` may be told to `stopLoading()`. This keeps the last-delivered bit of data alive, but stops any future loads from occurring. Most of this is handled for us in `AsyncTaskLoader`, but our implementation is called with `onStopLoading()`. `AbstractCursorLoader` uses this to call `cancelLoad()` and stop a load in progress, should one be going on presently:

```
* Must be called from the UI thread, triggered by a
* call to stopLoading().
*/
@Override
protected void onStopLoading() {
```

### onReset()

It is possible to `reset()` a Loader. If you think of `stopLoading()` as the equivalent of a “pause”, `reset()` is the equivalent of a “stop” — the Loader will no longer do anything until it is restarted. The Loader needs to retain enough of its state in order to start up again later on, but it does not need to hold onto anything else, including any previously-delivered results. `AsyncTaskLoader` handles much of this, but also calls `onReset()`, should you wish to hook into the event.

`AbstractCursorLoader` has an `onReset()` implementation that calls `onStopLoading()` first (to ensure that work gets done), then closes any `Cursor` that it might yet be holding onto:

```
* call to reset(). Here, we make sure our Cursor
* is closed, if it still exists and is not already closed.
*/
@Override
protected void onReset() {
    super.onReset();

    // Ensure the loader is stopped
    onStopLoading();

    if (lastCursor!=null && !lastCursor.isClosed()) {
        lastCursor.close();
    }
}
```

### SQLiteCursorLoader

All `SQLiteCursorLoader` needs to do is extend `AbstractCursorLoader` and implement `buildCursor()`:

```
@Override
protected Cursor buildCursor() {
    return(db.getReadableDatabase().rawQuery(rawQuery, args));
}
```

Here, we just call `rawQuery()` on the `SQLiteDatabase`, using the parameters supplied to the `SQLiteCursorLoader` constructor:

```
public SQLiteCursorLoader(Context context, SQLiteOpenHelper db,
                          String rawQuery, String[] args) {
    super(context);
    this.db=db;
    this.rawQuery=rawQuery;
    this.args=args;
}
```



## What Else Is Missing?

The Loader framework does an excellent job of handling queries in the background. What it does not do is help us with anything else that is supposed to be in the background, such as inserts, updates, deletes, or creating/upgrading the database. It is all too easy to put those on the main application thread and therefore possibly encounter issues. Moreover, since the thread(s) used by the Loader framework are an implementation detail, we cannot use those threads ourselves necessarily for the other CRUD operations.

## Issues, Issues, Issues

Unfortunately, not all is rosy with the Loader framework.

There appears to be a bug in the Android Support package's implementation of the framework. If you use a Loader from a fragment that has `setRetainInstance()` set to true, you will not be able to use the Loader again after a configuration change, such as a screen rotation. This bug is not seen with the native API Level 11+ implementation of the framework.

## Loaders Beyond Cursors

Loaders are not limited to loading something represented by a Cursor. You can load any sort of content that might take longer to load than you would want to spend on the main application thread. While the only concrete Loader implementation supplied by Android at this time loads a Cursor from a ContentProvider, you can create your own non-Cursor Loader implementation or employ one written by a third party.

In this section, we will take a look at other Loader implementations from the LoaderEx project, initially focusing on `SharedPreferencesLoader`.

### SharedPreferencesLoader

`SharedPreferences` are backed by an XML file. Hence, reading and writing preferences involves file I/O, which will cause `StrictMode` to get irritated when you do it on the main application thread. `SharedPreferencesLoader` handles two issues related to this:

## THE LOADER FRAMEWORK

---

- Loading the SharedPreferences on a background thread
- Providing a backwards-compatible means of persisting changes from a SharedPreferences.Editor on a background thread (which is native to API Level 9 but is not supported on earlier versions of Android)

### Usage

Basically, you would use SharedPreferencesLoader in much the same way you would use CursorLoader or SQLiteCursorLoader, except that everywhere you see a Cursor, replace it with a SharedPreferences. So, for example, you would need to implement LoaderManager.LoaderCallbacks<SharedPreferences> instead of LoaderManager.LoaderCallbacks<Cursor>.

For example, from the LoaderEx demo project, here is SharedPreferencesACLDemo, an activity that uses the Android Support package edition of the Loader framework and its corresponding implementation of SharedPreferencesLoader:

```
package com.commonware.cwac.loaderex.demo;

import android.content.SharedPreferences;
import android.os.Bundle;
import android.support.v4.app.FragmentActivity;
import android.support.v4.app.LoaderManager;
import android.support.v4.content.Loader;
import android.widget.TextView;
import com.commonware.cwac.loaderex.acl.SharedPreferencesLoader;

public class SharedPreferencesACLDemo extends FragmentActivity
    implements LoaderManager.LoaderCallbacks<SharedPreferences> {
    private static final String KEY="sample";
    private TextView tv;

    @Override
    public void onCreate(Bundle savedInstanceState) {
        super.onCreate(savedInstanceState);
        setContentView(R.layout.prefs);

        tv=(TextView)findViewById(R.id.pref);
        getSupportLoaderManager().initLoader(0, null, this);
    }

    @Override
    public Loader<SharedPreferences> onCreateLoader(int id, Bundle args) {
        return(new SharedPreferencesLoader(this));
    }

    @Override
    public void onLoadFinished(Loader<SharedPreferences> loader,
```

## THE LOADER FRAMEWORK

---

```
        SharedPreferences prefs) {
    int value=prefs.getInt(KEY, 0);

    value+=1;
    tv.setText(String.valueOf(value));

    SharedPreferences.Editor editor=prefs.edit();

    editor.putInt(KEY, value);

    SharedPreferencesLoader.persist(editor);
}

@Override
public void onLoadReset(Loader<SharedPreferences> arg0) {
    // unused
}
}
```

The activity implements `LoaderManager.LoaderCallbacks<SharedPreferences>` and in `onCreate()` calls `initLoader()` as before on the `LoaderManager`. The `onCreateLoader()` method returns the `SharedPreferencesLoader`, whose constructor only needs the activity itself (or some other valid `Context`).

The `onLoadFinished()` method receives the `SharedPreferencesLoader` and the `SharedPreferences` itself. In the demo, we read a number out of the `SharedPreferences` (defaulting to 0 for the first run), increment it, and put the value on the screen in a `TextView`. Then, we update the `SharedPreferences` object with the new value via a `SharedPreferences.Editor`. However, rather than calling `commit()` (available in all API levels but executed on the current thread) or `apply()` (executed on a background thread but not available until API Level 9), we call `persist()` on the `SharedPreferencesLoader`, which handles the API level differences and writes the XML in the background.

You could conceivably do something in `onLoaderReset()`, though this has little meaning for `SharedPreferences`, and therefore is ignored in the demo.

### Implementation Notes

The implementation of `SharedPreferencesLoader` is much like that of `SQLiteCursorLoader`, but simpler.

The `loadInBackground()` uses `PreferenceManager` and `getDefaultSharedPreferences()` to load the `SharedPreferences`:

## THE LOADER FRAMEWORK

---

```
@Override
public SharedPreferences loadInBackground() {
    prefs=PreferenceManager.getDefaultSharedPreferences(getContext());
    prefs.registerOnSharedPreferenceChangeListener(this);

    return(prefs);
}
```

The SharedPreferences object is also retained by the SharedPreferencesLoader, so onStartLoading() can use it if it was previously loaded:

```
@Override
protected void onStartLoading() {
    if (prefs != null) {
        deliverResult(prefs);
    }

    if (takeContentChanged() || prefs == null) {
        forceLoad();
    }
}
```

The implementation of persist() examines the build version, and if we are on API Level 9 or higher, uses apply() on the SharedPreferences.Editor to save any changes. Otherwise, it runs commit() in a background thread of its own creation:

```
public static void persist(final SharedPreferences.Editor editor) {
    if (Build.VERSION.SDK_INT >= Build.VERSION_CODES.GINGERBREAD) {
        editor.apply();
    }
    else {
        new Thread() {
            public void run() {
                editor.commit();
            }
        }.run();
    }
}
```

## What Happens When...?

Here are some other common development scenarios and how the Loader framework addresses them.

### ... the Data Behind the Loader Changes?

According to [the Loader documentation](#), “They monitor the source of their data and deliver new results when the content changes”.

The documentation is incorrect.

A Loader *can* “monitor the source of their data and deliver new results when the content changes”. There is nothing in the framework that requires this behavior. Moreover, there are some cases where is clearly a bad idea to do this — imagine a Loader loading data off of the Internet, needing to constantly poll some server to look for changes.

The documentation for a Loader implementation should tell you the rules. Android’s built-in `CursorLoader` does deliver new results, by means of a behind-the-scenes `ContentObserver`. `SQLiteCursorLoader` does not deliver new results at this time. `SharedPreferencesLoader` hands you a `SharedPreferences` object, which intrinsically is aware of any changes, and so `SharedPreferencesLoader` does nothing special here.

### ... the Configuration Changes?

The managed `Cursor` system that the Loader framework replaces would automatically requery() any managed `Cursor` objects when an activity was restarted. This would update the `Cursor` in place with fresh data after a configuration change. Of course, it would do that on the main application thread, which was not ideal.

Your Loader objects are retained across the configuration change automatically. Barring bugs in a specific Loader implementation, your Loader should then hand the new activity instance the data that was retrieved on behalf of the old activity instance (e.g., the `Cursor`).

Hence, you do not have to do anything special for configuration changes.

### ... the Activity is Destroyed?

Another thing the managed `Cursor` system gave you was the automatic closing of your `Cursor` when the activity was destroyed. The Loader framework does this as

well, by triggering a reset of the Loader, which obligates the Loader to release any loaded data.

### **... the Activity is Stopped?**

The final major feature of the managed Cursor system was that it would `deactivate()` a managed Cursor when the activity was stopped. This would release all of the heap space held by that Cursor while it was not on the screen. Since the Cursor was refreshed as part of restarting the activity, this usually worked fairly well and would help minimize pressure on the heap.

Alas, this does not appear to be supported by the Loader framework. The Loader is reset when an activity is destroyed, not stopped. Hence, the Loader data will continue to tie up heap space even while the activity is not in the foreground.

For many activities, this should not pose a problem, as the heap space consumed by their Cursor objects is modest. If you have an activity with a massive Cursor, though, you may wish to consider what steps you can take on your own, outside of the Loader framework, to help with this.



# The ContactsContract Provider

---

One of the more popular stores of data on your average Android device is the contact list. This is particularly true with Android 2.0 and newer versions, which track contacts across multiple different “accounts”, or sources of contacts. Some may come from your Google account, while others might come from Exchange or other services.

This chapter will walk you through some of the basics for accessing the contacts on the device. Along the way, we will revisit and expand upon our knowledge of using a ContentProvider.

First, we will review the [contacts APIs](#), past and present. We will then demonstrate how you can connect to the contacts engine to let users [pick and view contacts...](#) all without your application needing to know much of how contacts work. We will then show how you can [query](#) the contacts provider to obtain contacts and some of their details, like email addresses and phone numbers. We wrap by showing how you can invoke a built-in activity to let the user [add a new contact](#), possibly including some data supplied by your application.

## Prerequisites

Understanding this chapter requires that you have read the chapters on:

- [content provider theory](#)
- [content provider implementations](#)



## Introducing You to Your Contacts

Android makes contacts available to you via a complex `ContentProvider` framework, so you can access many facets of a contact's data — not just their name, but addresses, phone numbers, groups, etc. Working with the contacts `ContentProvider` set is simple... only if you have an established pattern to work with. Otherwise, it may prove somewhat daunting.

### Organizational Structure

The contacts `ContentProvider` framework can be found as the set of `ContactsContract` classes and interfaces in the `android.provider` package. Unfortunately, there is a dizzying array of inner classes to `ContactsContract`.

Contacts can be broken down into two types: raw and aggregate. Raw contacts come from a sync provider or are hand-entered by a user. Aggregate contacts represent the sum of information about an individual culled from various raw contacts. For example, if your Exchange sync provider has a contact with an email address of `jdoe@foo.com`, and your Facebook sync provider has a contact with an email address of `jdoe@foo.com`, Android may recognize that those two raw contacts represent the same person and therefore combine those in the aggregate contact for the user. The classes relating to raw contacts usually have `Raw` somewhere in their name, and these normally would be used only by custom sync providers.

The `ContactsContract.Contacts` and `ContactsContract.Data` classes represent the “entry points” for the `ContentProvider`, allowing you to query and obtain information on a wide range of different pieces of information. What is retrievable from these can be found in the various `ContactsContract.CommonDataKinds` series of classes. We will see examples of these operations later in this chapter.

### A Look Back at Android 1.6

Prior to Android 2.0, Android had no contact synchronization built in. As a result, all contacts were in one large pool, whether they were hand-entered by users or were added via third-party applications. The API used for this is the `Contacts ContentProvider`.

In principle, the `Contacts ContentProvider` should still work, as it is merely deprecated in Android 2.0.1, not removed. In practice, it has one big limitation: it

will only report contacts added directly to the device (as opposed to ones synchronized from Microsoft Exchange, Facebook, or other sources).

## Pick a Peck of Pickled People

Let's start by finding a contact. After all, that's what the contacts system is for.

Contacts, like anything stored in a `ContentProvider`, is identified by a `Uri`. Hence, we need a `Uri` we can use in the short term, perhaps to read some data, or perhaps just to open up the contact detail activity for the user.

We could ask for a raw contact, or we could ask for an aggregate contact. Since most consumers of the contacts `ContentProvider` will want the aggregate contact, we will use that.

For example, take a look at the [Contacts/Pick](#) sample project, as this shows how to pick a contact from a collection of contacts, then display the contact detail activity. This application gives you a really big "Gimme!" button, which when clicked will launch the contact-selection logic:

```
<?xml version="1.0" encoding="utf-8"?>
<Button xmlns:android="http://schemas.android.com/apk/res/android"
    android:id="@+id/pick"
    android:layout_width="match_parent"
    android:layout_height="match_parent"
    android:text="Gimme a contact!"
    android:layout_weight="1"
/>
```

Our first step is to determine the `Uri` to use to reference the collection of contacts we want to pick from. In the long term, there should be just one answer for aggregate contacts:

`android.provider.ContactsContract.Contacts.People.CONTENT_URI`. However, that only works for Android 2.0 (SDK level 5) and higher. On older versions of Android, we need to stick with the original `android.provider.Contacts.CONTENT_URI`. To accomplish this, we will use a pinch of reflection to determine our `Uri` via a static initializer when our activity starts:

```
private static Uri CONTENT_URI=null;

static {
    int sdk=new Integer(Build.VERSION.SDK).intValue();

    if (sdk>=5) {
```

## THE CONTACTS CONTRACT PROVIDER

---

```
try {
    Class<?>
clazz=Class.forName("android.provider.ContactsContract$Contacts");

    CONTENT_URI=(Uri)clazz.getField("CONTENT_URI").get(clazz);
}
catch (Throwable t) {
    Log.e("PickDemo", "Exception when determining CONTENT_URI", t);
}
}
else {
    CONTENT_URI=Contacts.People.CONTENT_URI;
}
}
```

Then, you need to create an Intent for the ACTION\_PICK on the chosen Uri, then start another activity (via startActivityForResult()) to allow the user to pick a piece of content of the specified type:

```
Intent i=new Intent(Intent.ACTION_PICK, CONTENT_URI);

startActivityForResult(i, PICK_REQUEST);
```

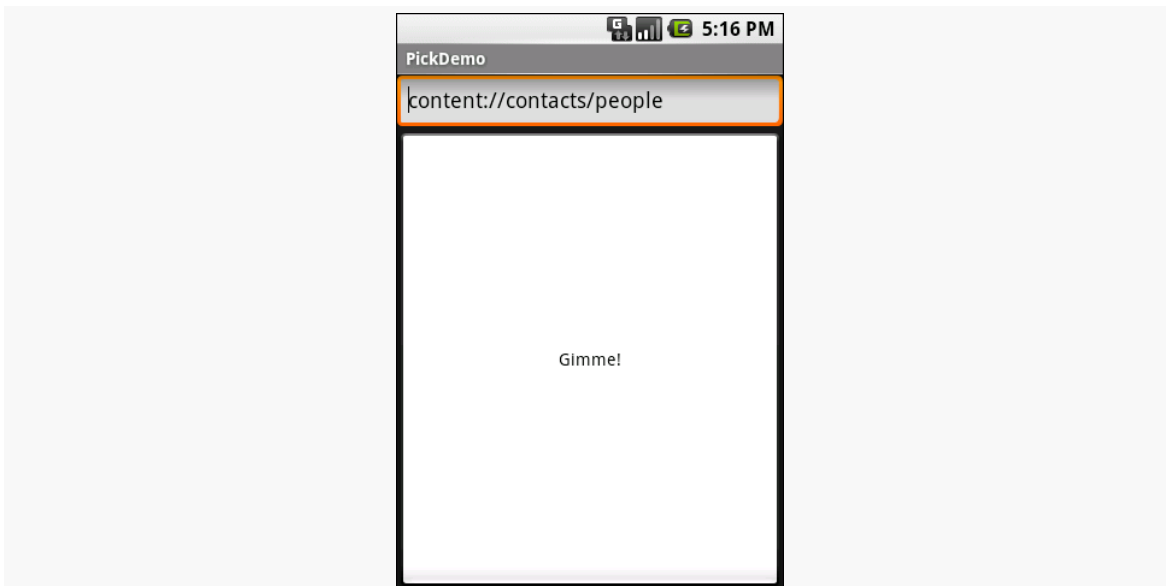
When that spawned activity completes with RESULT\_OK, the ACTION\_VIEW is invoked on the resulting contact Uri, as obtained from the Intent returned by the pick activity:

```
@Override
protected void onActivityResult(int requestCode, int resultCode,
                                Intent data) {
    if (requestCode==PICK_REQUEST) {
        if (resultCode==RESULT_OK) {
            startActivity(new Intent(Intent.ACTION_VIEW,
                                    data.getData()));
        }
    }
}
```

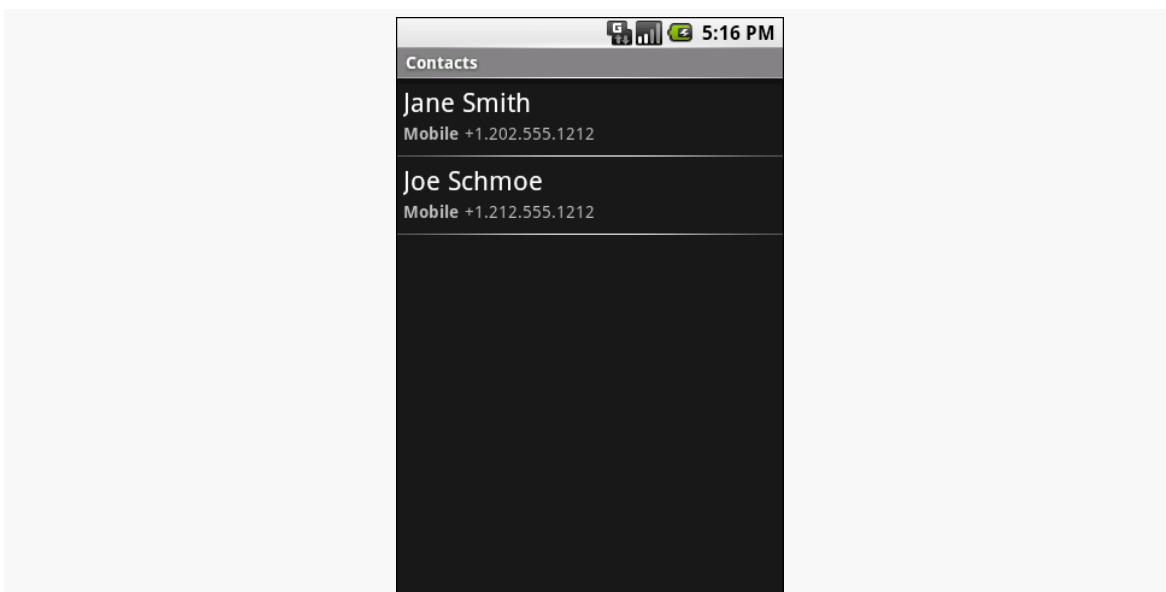
The result: the user chooses a collection, picks a piece of content, and views it.

## THE CONTACTS CONTRACT PROVIDER

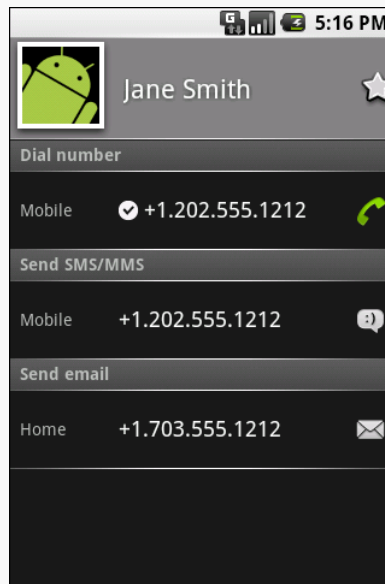
---



*Figure 361: The PickDemo sample application, as initially launched*



*Figure 362: The same application, after clicking the “Gimme!” button, showing the list of available people*



*Figure 363: A view of a contact, launched by PickDemo after choosing one of the people from the pick list*

Note that the `Uri` we get from picking the contact is valid in the short term, but should not be held onto in a persistent fashion (e.g., put in a database). If you need to try to store a reference to a contact for the long term, you will need to get a “lookup `Uri`” on it, to help deal with the fact that the aggregate contact may shift over time as raw contact information for that person comes and goes.

## Spin Through Your Contacts

The preceding example allows you to work with contacts, yet not actually have any contact data other than a transient `Uri`. All else being equal, it is best to use the contacts system this way, as it means you do not need any extra permissions that might raise privacy issues.

Of course, all else is rarely equal.

Your alternative, therefore, is to execute queries against the contacts `ContentProvider` to get actual contact detail data back, such as names, phone numbers, and email addresses. The [Contacts/Spinners](#) sample application will demonstrate this technique.

### Contact Permissions

Since contacts are privileged data, you need certain permissions to work with them. Specifically, you need the `READ_CONTACTS` permission to query and examine the `ContactsContract` content and `WRITE_CONTACTS` to add, modify, or remove contacts from the system. This only holds true if your code will have access to personally-identifying information, which is why the `Pick` sample above — which just has an opaque `Uri` — does not need any permission.

For example, here is the manifest for the `Contacts/Spinners` sample application:

```
<?xml version="1.0" encoding="utf-8"?>
<manifest android:versionCode="1"
    android:versionName="1.0"
    package="com.commonware.android.contacts.spinners"
    xmlns:android="http://schemas.android.com/apk/res/android">

    <uses-permission android:name="android.permission.READ_CONTACTS" />
    <uses-sdk android:minSdkVersion="3"
        android:targetSdkVersion="6" />
    <supports-screens android:largeScreens="true"
        android:normalScreens="true"
        android:smallScreens="false" />
    <application android:icon="@drawable/cw"
        android:label="@string/app_name">
        <activity android:label="@string/app_name"
            android:name=".ContactSpinners">
            <intent-filter>
                <action android:name="android.intent.action.MAIN" />
                <category android:name="android.intent.category.LAUNCHER" />
            </intent-filter>
        </activity>
    </application>
</manifest>
```

### Pre-Joined Data

While the database underlying the `ContactsContract` content provider is private, one can imagine that it has several tables: one for people, one for their phone numbers, one for their email addresses, etc. These are tied together by typical database relations, most likely 1:N, so the phone number and email address tables would have a foreign key pointing back to the table containing information about people.

To simplify accessing all of this through the content provider interface, Android pre-joins queries against some of the tables. For example, you can query for phone

numbers and get the contact name and other data along with the number — you do not have to do this join operation yourself.

### The Sample Activity

The ContactsDemo activity is simply a ListActivity, though it sports a Spinner to go along with the obligatory ListView:

```
<?xml version="1.0" encoding="utf-8"?>
<LinearLayout xmlns:android="http://schemas.android.com/apk/res/android"
    android:orientation="vertical"
    android:layout_width="fill_parent"
    android:layout_height="fill_parent"
    >
    <Spinner android:id="@+id/spinner"
        android:layout_width="fill_parent"
        android:layout_height="wrap_content"
        android:drawSelectorOnTop="true"
    />
    <ListView
        android:id="@android:id/list"
        android:layout_width="fill_parent"
        android:layout_height="fill_parent"
        android:drawSelectorOnTop="false"
    />
</LinearLayout>
```

The activity itself sets up a listener on the Spinner and toggles the list of information shown in the ListView when the Spinner value changes:

```
package com.commonware.android.contacts.spinners;

import android.app.ListActivity;
import android.os.Bundle;
import android.view.View;
import android.widget.AdapterView;
import android.widget.AdapterView.OnItemClickListener;
import android.widget.ArrayAdapter;
import android.widget.ListAdapter;
import android.widget.Spinner;

public class ContactSpinners extends ListActivity
    implements AdapterView.OnItemClickListener {
    private static String[] options={"Contact Names",
        "Contact Names & Numbers",
        "Contact Names & Email Addresses"};
    private ListAdapter[] listAdapters=new ListAdapter[3];

    @Override
    public void onCreate(Bundle savedInstanceState) {
        super.onCreate(savedInstanceState);
```

## THE CONTACTS CONTRACT PROVIDER

---

```
setContentView(R.layout.main);

initListAdapters();

Spinner spin=(Spinner)findViewById(R.id.spinner);
spin.setOnItemSelectedListener(this);

ArrayAdapter<String> aa=new ArrayAdapter<String>(this,
        android.R.layout.simple_spinner_item,
        options);

aa.setDropDownViewResource(
        android.R.layout.simple_spinner_dropdown_item);
spin.setAdapter(aa);
}

public void onItemSelected(AdapterView<?> parent,
        View v, int position, long id) {
    setListAdapter(listAdapters[position]);
}

public void onNothingSelected(AdapterView<?> parent) {
    // ignore
}

private void initListAdapters() {
    listAdapters[0]=ContactsAdapterBridge.INSTANCE.buildNameAdapter(this);
    listAdapters[1]=ContactsAdapterBridge.INSTANCE.buildPhonesAdapter(this);
    listAdapters[2]=ContactsAdapterBridge.INSTANCE.buildEmailAdapter(this);
}
}
```

When the activity is first opened, it sets up three Adapter objects, one for each of three perspectives on the contacts data. The Spinner simply resets the list to use the Adapter associated with the Spinner value selected.

### Dealing with API Versions

Of course, once again, we have to ponder different API levels.

Querying ContactsContract and querying Contacts is similar, yet different, both in terms of the `Uri` each uses for the query and in terms of the available column names for the resulting projection.

Rather than using reflection, this time we ruthlessly exploit a feature of the VM: classes are only loaded when first referenced. Hence, we can have a class that refers to new APIs (ContactsContract) on a device that lacks those APIs, so long as we do not reference that class.



## THE CONTACTS CONTRACT PROVIDER

---

To accomplish this, we define an abstract base class, `ContactsAdapterBridge`, that will have a singleton instance capable of running our queries and building a `ListAdapter` for each. Then, we create two concrete subclasses, one for the old API:

```
package com.commonware.android.contacts.spinners;

import android.app.Activity;
import android.database.Cursor;
import android.provider.Contacts;
import android.widget.ListAdapter;
import android.widget.SimpleCursorAdapter;

class OldContactsAdapterBridge extends ContactsAdapterBridge {
    ListAdapter buildNameAdapter(Activity a) {
        String[] PROJECTION=new String[] { Contacts.People._ID,
                                           Contacts.PeopleColumns.NAME
                                           };
        Cursor c=a.managedQuery(Contacts.People.CONTENT_URI,
                               PROJECTION, null, null,
                               Contacts.People.DEFAULT_SORT_ORDER);

        return(new SimpleCursorAdapter( a,
                                       android.R.layout.simple_list_item_1,
                                       c,
                                       new String[] {
                                           Contacts.PeopleColumns.NAME
                                       },
                                       new int[] {
                                           android.R.id.text1
                                       }
                                       ));
    }

    ListAdapter buildPhonesAdapter(Activity a) {
        String[] PROJECTION=new String[] { Contacts.Phones._ID,
                                           Contacts.Phones.NAME,
                                           Contacts.Phones.NUMBER
                                           };
        Cursor c=a.managedQuery(Contacts.Phones.CONTENT_URI,
                               PROJECTION, null, null,
                               Contacts.Phones.DEFAULT_SORT_ORDER);

        return(new SimpleCursorAdapter( a,
                                       android.R.layout.simple_list_item_2,
                                       c,
                                       new String[] {
                                           Contacts.Phones.NAME,
                                           Contacts.Phones.NUMBER
                                       },
                                       new int[] {
                                           android.R.id.text1,
                                           android.R.id.text2
                                       }
                                       ));
    }
}
```

## THE CONTACTS CONTRACT PROVIDER

---

```
ListAdapter buildEmailAdapter(Activity a) {
    String[] PROJECTION=new String[] { Contacts.ContactMethods._ID,
                                       Contacts.ContactMethods.DATA,
                                       Contacts.PeopleColumns.NAME
                                       };
    Cursor c=a.managedQuery(Contacts.ContactMethods.CONTENT_EMAIL_URI,
                           PROJECTION, null, null,
                           Contacts.ContactMethods.DEFAULT_SORT_ORDER);

    return(new SimpleCursorAdapter( a,
                                    android.R.layout.simple_list_item_2,
                                    c,
                                    new String[] {
                                        Contacts.PeopleColumns.NAME,
                                        Contacts.ContactMethods.DATA
                                    },
                                    new int[] {
                                        android.R.id.text1,
                                        android.R.id.text2
                                    }));
}
```

... and one for the new API:

```
package com.commonware.android.contacts.spinners;

import android.app.Activity;
import android.database.Cursor;
import android.provider.ContactsContract.Contacts;
import android.provider.ContactsContract.CommonDataKinds.Email;
import android.provider.ContactsContract.CommonDataKinds.Phone;
import android.widget.ListAdapter;
import android.widget.SimpleCursorAdapter;

class NewContactsAdapterBridge extends ContactsAdapterBridge {
    ListAdapter buildNameAdapter(Activity a) {
        String[] PROJECTION=new String[] { Contacts._ID,
                                           Contacts.DISPLAY_NAME,
                                           };
        Cursor c=a.managedQuery(Contacts.CONTENT_URI,
                               PROJECTION, null, null, null);

        return(new SimpleCursorAdapter( a,
                                        android.R.layout.simple_list_item_1,
                                        c,
                                        new String[] {
                                            Contacts.DISPLAY_NAME
                                        },
                                        new int[] {
                                            android.R.id.text1
                                        }));
    }
}
```

## THE CONTACTS CONTRACT PROVIDER

---

```
}

ListAdapter buildPhonesAdapter(Activity a) {
    String[] PROJECTION=new String[] { Contacts._ID,
                                       Contacts.DISPLAY_NAME,
                                       Phone.NUMBER
                                       };
    Cursor c=a.managedQuery(Phone.CONTENT_URI,
                           PROJECTION, null, null, null);

    return(new SimpleCursorAdapter( a,
                                    android.R.layout.simple_list_item_2,
                                    c,
                                    new String[] {
                                        Contacts.DISPLAY_NAME,
                                        Phone.NUMBER
                                    },
                                    new int[] {
                                        android.R.id.text1,
                                        android.R.id.text2
                                    }));
}

ListAdapter buildEmailAdapter(Activity a) {
    String[] PROJECTION=new String[] { Contacts._ID,
                                       Contacts.DISPLAY_NAME,
                                       Email.DATA
                                       };
    Cursor c=a.managedQuery(Email.CONTENT_URI,
                           PROJECTION, null, null, null);

    return(new SimpleCursorAdapter( a,
                                    android.R.layout.simple_list_item_2,
                                    c,
                                    new String[] {
                                        Contacts.DISPLAY_NAME,
                                        Email.DATA
                                    },
                                    new int[] {
                                        android.R.id.text1,
                                        android.R.id.text2
                                    }));
}
}
```

Our ContactsAdapterBridge class then uses the SDK level to determine which of those two classes to use as the singleton:

```
package com.commonware.android.contacts.spinners;

import android.app.Activity;
import android.os.Build;
import android.widget.ListAdapter;
```

## THE CONTACTS CONTRACT PROVIDER

---

```
abstract class ContactsAdapterBridge {
    abstract ListAdapter buildNameAdapter(Activity a);
    abstract ListAdapter buildPhonesAdapter(Activity a);
    abstract ListAdapter buildEmailAdapter(Activity a);

    public static final ContactsAdapterBridge INSTANCE=buildBridge();

    private static ContactsAdapterBridge buildBridge() {
        int sdk=new Integer(Build.VERSION.SDK).intValue();

        if (sdk<5) {
            return(new OldContactsAdapterBridge());
        }

        return(new NewContactsAdapterBridge());
    }
}
```

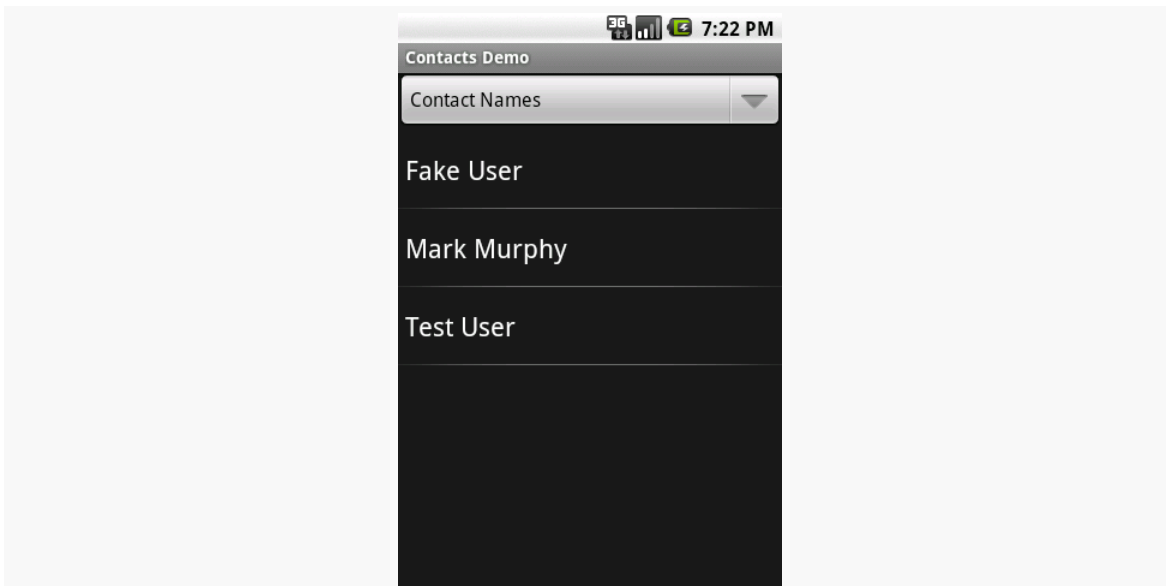
### Accessing Contact Information

The first Adapter shows the names of all of the contacts. Since all the information we seek is in the contact itself, we can use the `CONTENT_URI` provider, retrieve all of the contacts in the default sort order, and pour them into a `SimpleCursorAdapter` set up to show each person on its own row:

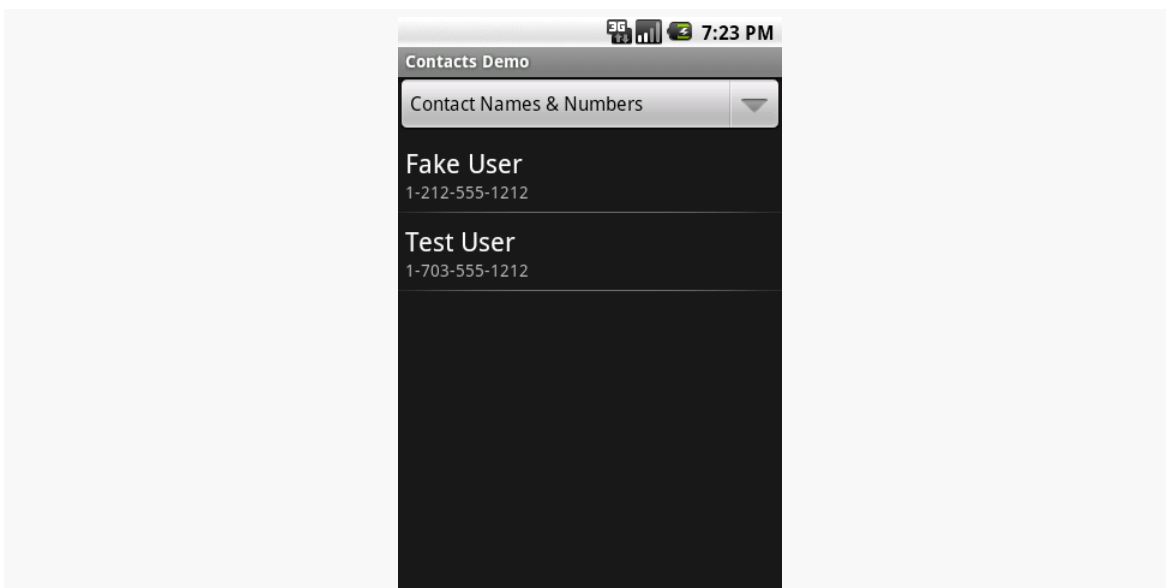
Assuming you have some contacts in the database, they will appear when you first open the `ContactsDemo` activity, since that is the default perspective:

## THE CONTACTS CONTRACT PROVIDER

---

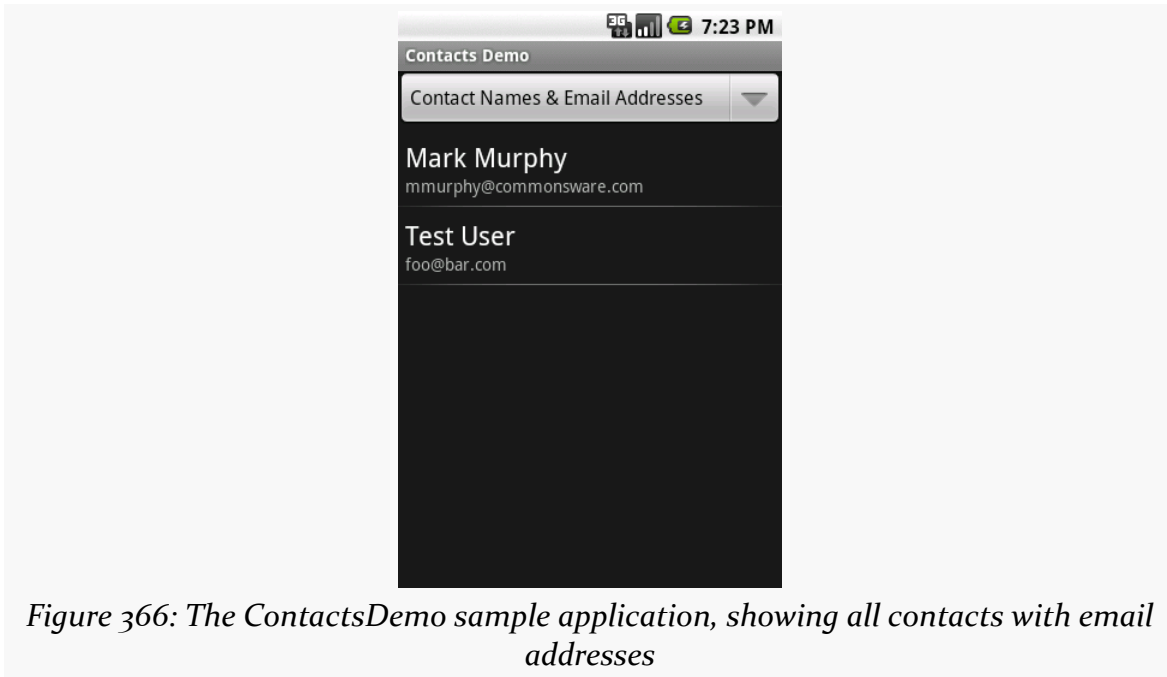


*Figure 364: The ContactsDemo sample application, showing all contacts*



*Figure 365: The ContactsDemo sample application, showing all contacts that have phone numbers*

Similarly, to get a list of all the email addresses, we can use the `CONTENT_URI` content provider. Again, the results are displayed via a two-line `SimpleCursorAdapter`:



*Figure 366: The ContactsDemo sample application, showing all contacts with email addresses*

## Makin' Contacts

Let's now take a peek at the reverse direction: adding contacts to the system. This was never particularly easy and now is... well, different.

First, we need to distinguish between sync providers and other apps. Sync providers are the guts underpinning the accounts system in Android, bridging some existing source of contact data to the Android device. Hence, you can have sync providers for Exchange, Facebook, and so forth. These will need to create raw contacts for newly-added contacts to their backing stores that are being sync'd to the device for the first time. Creating sync providers is outside of the scope of this book for now.

It is possible for other applications to create contacts. These, by definition, will be phone-only contacts, lacking any associated account, no different than if the user added the contact directly. The recommended approach to doing this is to collect the data you want, then spawn an activity to let the user add the contact — this avoids your application needing the `WRITE_CONTACTS` permission and all the privacy/data integrity issues that creates. In this case, we will stick with the new `ContactsContract` content provider, to simplify our code, at the expense of requiring Android 2.0 or newer.

## THE CONTACTS CONTRACT PROVIDER

---

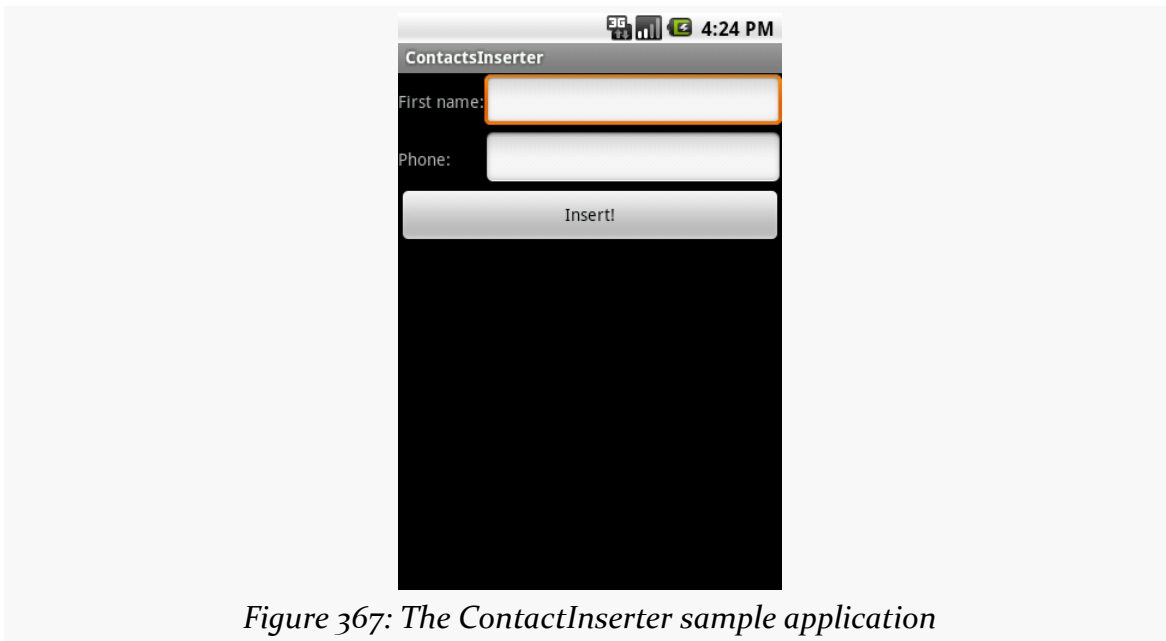
To that end, take a look at the [Contacts/Inserter](#) sample project. It defines a simple activity with a two-field UI, with one field apiece for the person's first name and phone number:

```
<?xml version="1.0" encoding="utf-8"?>
<TableLayout xmlns:android="http://schemas.android.com/apk/res/android"
    android:orientation="vertical"
    android:layout_width="match_parent"
    android:layout_height="match_parent"
    android:stretchColumns="1"
    >
    <TableRow>
        <TextView
            android:text="First name:"
            />
        <EditText android:id="@+id/name"
            />
    </TableRow>
    <TableRow>
        <TextView
            android:text="Phone:"
            />
        <EditText android:id="@+id/phone"
            android:inputType="phone"
            />
    </TableRow>
    <Button android:id="@+id/insert" android:text="Insert!" />
</TableLayout>
```

The trivial UI also sports a button to add the contact:

## THE CONTACTS CONTRACT PROVIDER

---



*Figure 367: The ContactInserter sample application*

When the user clicks the button, the activity gets the data and creates an Intent to be used to launch the add-a-contact activity. This uses the ACTION\_INSERT\_OR\_EDIT action and a couple of extras from the ContactsContract.Intents.Insert class:

```
package com.commonware.android.inserter;

import android.app.Activity;
import android.content.Intent;
import android.os.Bundle;
import android.provider.ContactsContract.Contacts;
import android.provider.ContactsContract.Intents.Insert;
import android.view.View;
import android.widget.Button;
import android.widget.EditText;

public class ContactsInserter extends Activity {
    @Override
    public void onCreate(Bundle savedInstanceState) {
        super.onCreate(savedInstanceState);
        setContentView(R.layout.main);

        Button btn=(Button)findViewById(R.id.insert);

        btn.setOnClickListener(onInsert);
    }

    View.OnClickListener onInsert=new View.OnClickListener() {
        public void onClick(View v) {
            EditText fld=(EditText)findViewById(R.id.name);
```



## THE CONTACTS CONTRACT PROVIDER

---

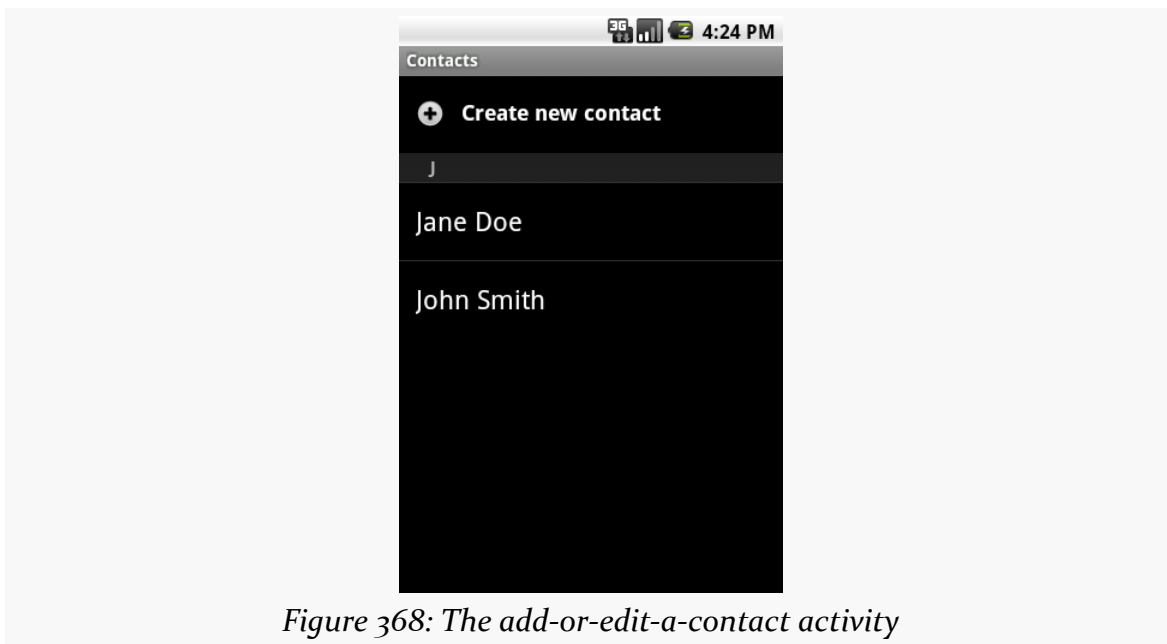
```
String name=fld.getText().toString();

fld=(EditText)findViewById(R.id.phone);

String phone=fld.getText().toString();
Intent i=new Intent(Intent.ACTION_INSERT_OR_EDIT);

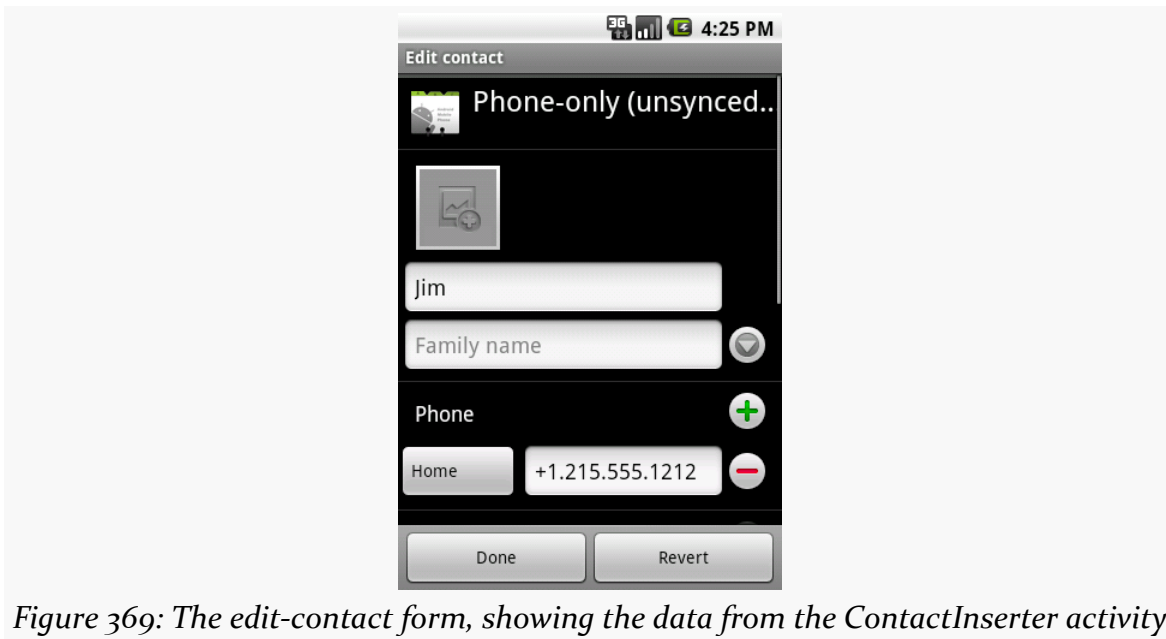
i.setType(Contacts.CONTENT_ITEM_TYPE);
i.putExtra(Insert.NAME, name);
i.putExtra(Insert.PHONE, phone);
startActivity(i);
}
};
}
```

We also need to set the MIME type on the Intent via `setType()`, to be `CONTENT_ITEM_TYPE`, so Android knows what sort of data we want to actually insert. Then, we call `startActivity()` on the resulting Intent. That brings up an add-or-edit activity:



*Figure 368: The add-or-edit-a-contact activity*

... where if the user chooses “Create new contact”, they are taken to the ordinary add-a-contact activity, with our data pre-filled in:



*Figure 369: The edit-contact form, showing the data from the ContactInserter activity*

Note that the user could choose an existing contact, rather than creating a new contact. If they choose an existing contact, the first name of that contact will be overwritten with the data supplied by the ContactsInserter activity, and a new phone number will be added from those Intent extras.



# The CalendarContract Provider

---

The Android Open Source Project (AOSP) has had a Calendar application from its earliest days. This application originally was designed to sync with Google Calendar, later extended to other sync sources, such as Microsoft's Exchange. However, this application was not part of the Android SDK, so there was no way to access it from your Android application.

At least, no officially documented and supported way.

Many developers poked through the AOSP source code and found that the Calendar application had a `ContentProvider`. Moreover, this `ContentProvider` was exported (by default). So many developers used undocumented and unsupported means for accessing calendar information. This occasionally broke, as Google modified the Calendar app and changed these pseudo-external interfaces.

Android 4.0 added official SDK support for interacting with the Calendar application via its `ContentProvider`. As part of the SDK, these new interfaces should be fairly stable — if nothing else, they should be supported indefinitely, even if new and improved interfaces are added sometime in the future. So, if you want to tie into the user's calendars, you can. Bear in mind, though, that the new `CalendarContract` `ContentProvider` is not identical to the older undocumented providers, so if you are aiming to support pre-4.0 devices, you have some more work to do.

Of course, similar to the `ContactsContract` `ContentProvider`, the `CalendarContract` `ContentProvider` is severely lacking in documentation, and anything not documented is subject to change.

### Prerequisites

Understanding this chapter requires that you have read the chapters on:

- [content provider theory](#)
- [content provider implementations](#)

### You Can't Be a Faker

While the Android 4.0 emulator has the `CalendarContract` `ContentProvider`, it will do you little good. While you can define a Google account on the emulator, the emulator lacks any ability to sync content with that account. Hence, you cannot see any events for your calendars in the Calendar app, and you cannot access any calendar data via `CalendarContract`.

Hence, at present, in order to test your use of `CalendarContract`, you will need to have hardware that runs Android 4.0 (or higher), with one or more accounts set up that have calendar data.

### Do You Have Room on Your Calendar?

As a `ContentProvider`, `CalendarContract` is not significantly different from any other such provider that Android supplies or that you write yourself, in that there are `Uri` values representing collections of data, upon which you can query, insert, update, and delete as needed.

### The Collections

The two main collections of data that you are likely to be interested in are `CalendarContract`.`Calendars` (the collection of all defined calendars) and `CalendarContract`.`Events` (the collection of all defined events across all calendars). Each of those has a `CONTENT_URI` static data member that you would use with `ContentResolver` or a `CursorLoader` to perform operations on those collections. An entry in `CalendarContract`.`Events` points back to its corresponding calendar via a `CALENDAR_ID` column that you can query upon; the remaining columns on `CalendarContract`.`Events` have names apparently designed to match with the [iCalendar specification](#) (e.g., `DTSTART` and `DTEND` for the start and end times of the event).

## THE CALENDARCONTRACT PROVIDER

---

Three other collections may be of interest:

1. `CalendarContract.Instances` has one entry per occurrence of an event, so recurring events get multiple rows
2. `CalendarContract.Attendees` has information about each attendee of an event
3. `CalendarContract.Reminders` has information about each reminder scheduled for an event (e.g., when to remind the user), for those events with associated reminders

Each of those ties back to its associated `CalendarContract.Events` row via an `EVENT_ID` column.

### Calendar Permissions

There are two permissions for working with `CalendarContract`: `READ_CALENDAR` and `WRITE_CALENDAR`. As you might expect, querying `CalendarContract` requires the `READ_CALENDAR` permission; modifying `CalendarContract` data requires the `WRITE_CALENDAR` permission.

These permissions have existed since Android's earliest days, even in the SDK, as a side effect of the "meat cleaver" approach the core Android team employed to create the initial SDK. Hence, you can request these permissions in the manifest with any Android build target, without compiler errors. Of course, actually referring to `CalendarContract` will require a build target of API Level 14 or higher.

### Querying for Events

For example, let's populate a `ListView` with the roster of all events the user has across all calendars, using a `CursorLoader`, showing the name of each event, the event's start date, and the event's end date. You can find this in the [Calendar/Query](#) sample project in the book's source code.

Our manifest has the `READ_CALENDARS` permission, as you would expect:

```
<?xml version="1.0" encoding="utf-8"?>
<manifest xmlns:android="http://schemas.android.com/apk/res/android"
    package="com.commonware.android.cal.query"
    android:versionCode="1"
    android:versionName="1.0">

    <uses-sdk android:minSdkVersion="14"/>
```

## THE CALENDARCONTRACT PROVIDER

---

```
<uses-permission android:name="android.permission.READ_CALENDAR" />

<application
    android:icon="@drawable/ic_launcher"
    android:label="@string/app_name">
    <activity
        android:name=".CalendarQueryActivity"
        android:label="@string/app_name">
        <intent-filter>
            <action android:name="android.intent.action.MAIN" />

            <category android:name="android.intent.category.LAUNCHER" />
        </intent-filter>
    </activity>
</application>

</manifest>
```

We will use a simple `ListActivity` and so therefore do not need an activity layout. Our row layout (`res/layout/row.xml`) has three `TextView` widgets for the three pieces of data that we want to display:

```
<LinearLayout xmlns:android="http://schemas.android.com/apk/res/android"
    android:id="@+id/linearLayout1"
    android:layout_width="fill_parent"
    android:layout_height="wrap_content">

    <TextView
        android:id="@+id/title"
        android:layout_width="wrap_content"
        android:layout_height="wrap_content"
        android:layout_gravity="center_vertical"
        android:layout_marginLeft="4dip"
        android:layout_marginRight="4dip"
        android:layout_weight="1"
        android:ellipsize="end"
        android:textSize="20sp" />

    <LinearLayout
        android:id="@+id/linearLayout2"
        android:layout_width="wrap_content"
        android:layout_height="match_parent"
        android:layout_marginRight="4dip"
        android:orientation="vertical">

        <TextView
            android:id="@+id/dtstart"
            android:layout_width="wrap_content"
            android:layout_height="wrap_content"
            android:layout_gravity="top"
            android:textSize="10sp" />

        <TextView
```

## THE CALENDARCONTRACT PROVIDER

---

```
        android:id="@+id/dtend"  
        android:layout_width="wrap_content"  
        android:layout_height="wrap_content"  
        android:layout_gravity="bottom"  
        android:textSize="10sp"/>  
    </LinearLayout>  
</LinearLayout>
```

In our activity (CalendarQueryActivity), in onCreate(), we set up a SimpleCursorAdapter on a null Cursor at the outset and define the activity as being the adapter's ViewBinder:

```
@Override  
public void onCreate(Bundle savedInstanceState) {  
    super.onCreate(savedInstanceState);  
  
    adapter=  
        new SimpleCursorAdapter(this, R.layout.row, null, ROW_COLUMNS,  
                                ROW_IDS);  
    adapter.setViewBinder(this);  
    setListAdapter(adapter);  
  
    getLoaderManager().initLoader(0, null, this);  
}
```

A ViewBinder is a way to tailor how Cursor data is poured into row widgets, without subclassing the SimpleCursorAdapter. Implementing the SimpleCursorAdapter.ViewBinder interface requires us to implement a setViewValue() method, which will be called when the adapter wishes to pour data from one column of a Cursor into one widget. We will examine this method shortly.

The SimpleCursorAdapter will pour data from the ROW\_COLUMNS in our Cursor into the ROW\_IDS widgets in our row layout:

```
private static final String[] ROW_COLUMNS=  
    new String[] { CalendarContract.Events.TITLE,  
                  CalendarContract.Events.DTSTART,  
                  CalendarContract.Events.DTEND };  
private static final int[] ROW_IDS=  
    new int[] { R.id.title, R.id.dtstart, R.id.dtend };
```

Our onCreate() also initializes the Loader framework, triggering a call to onCreateLoader(), where we create and return a CursorLoader:

```
public Loader<Cursor> onCreateLoader(int loaderId, Bundle args) {  
    return(new CursorLoader(this, CalendarContract.Events.CONTENT_URI,  
                            PROJECTION, null, null,
```



## THE CALENDARCONTRACT PROVIDER

---

```
        CalendarContract.Events.DTSTART));  
    }
```

We query on `CalendarContract.Events.CONTENT_URI`, asking for a certain set of columns indicated by our `PROJECTION` static data member:

```
private static final String[] PROJECTION=  
    new String[] { CalendarContract.Events._ID,  
        CalendarContract.Events.TITLE,  
        CalendarContract.Events.DTSTART,  
        CalendarContract.Events.DTEND };
```

The `ROW_COLUMNS` we map are a subset of the `PROJECTION`, skipping the `_ID` column that `SimpleCursorAdapter` needs but will not be displayed. Our query is also set up to sort by the start date (`CalendarContract.Events.DTSTART`).

When the query is complete, we pop it into the adapter in `onLoadFinished()` and remove it in `onLoaderReset()`:

```
public void onLoadFinished(Loader<Cursor> loader, Cursor cursor) {  
    adapter.swapCursor(cursor);  
}  
  
public void onLoaderReset(Loader<Cursor> loader) {  
    adapter.swapCursor(null);  
}
```

Our `setViewValue()` implementation then converts the `DTSTART` and `DTEND` values into formatted strings by way of `DateUtils` and the `formatDateTime()` method:

```
@Override  
public boolean setViewValue(View view, Cursor cursor, int columnIndex) {  
    long time=0;  
    String formattedTime=null;  
  
    switch (columnIndex) {  
        case 2:  
        case 3:  
            time=cursor.getLong(columnIndex);  
            formattedTime=  
                DateUtils.formatDateTime(this, time,  
                    DateUtils.FORMAT_ABBREV_RELATIVE);  
            ((TextView)view).setText(formattedTime);  
            break;  
  
        default:  
            return(false);  
    }  
}
```

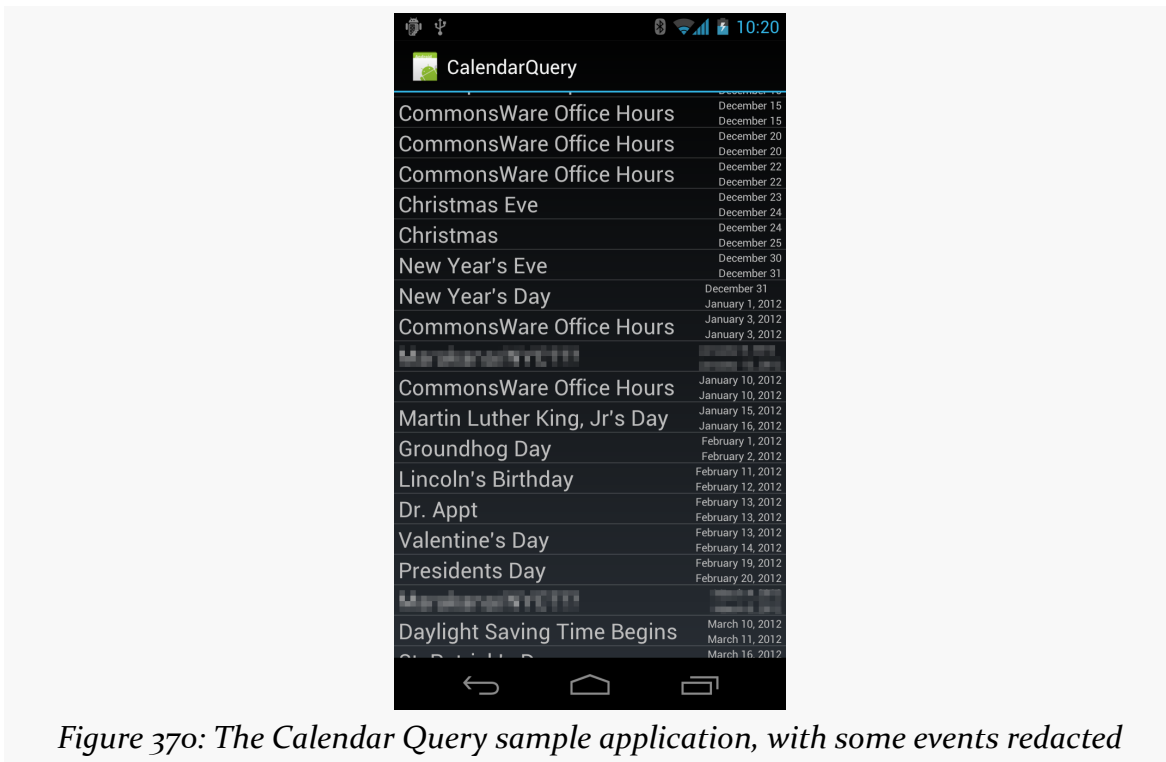
## THE CALENDARCONTRACT PROVIDER

---

```
    return(true);  
  }  
}
```

The `setViewValue()` method should return `true` for any columns it handles and `false` for columns it does not — skipped columns are handled by `SimpleCursorAdapter` itself.

If you run this on a device with available calendar data, you will get a list of those events:



*Figure 370: The Calendar Query sample application, with some events redacted*

## Penciling In an Event

What is rarely documented in the Android SDK is what activities might exist that support the MIME types of a given `ContentProvider`. In part, that is because device manufacturers have the right to remove or replace many of the built-in applications.

The Calendar application is considered by Google to be a “core” application. Quoting the Android 2.3 version of the [Compatibility Definition Document](#) (CDD):

## THE CALENDARCONTRACT PROVIDER

---

The Android upstream project defines a number of core applications, such as a phone dialer, calendar, contacts book, music player, and so on. Device implementers MAY replace these applications with alternative versions. However, any such alternative versions MUST honor the same Intent patterns provided by the upstream project. For example, if a device contains an alternative music player, it must still honor the Intent pattern issued by third-party applications to pick a song.

Hence, in theory, so long as the CDD does not change and device manufacturers correctly honor it, those Intent patterns described by the Calendar application's manifest should be available across Android 4.0 devices. The Calendar application appears to support ACTION\_INSERT and ACTION\_EDIT for both the collection MIME type (`vnd.android.cursor.dir/event`) and the instance MIME type (`vnd.android.cursor.item/event`). Notably, there is no support for ACTION\_PICK to pick a calendar or event, the way you can use ACTION\_PICK to pick a contact.

# Encrypted Storage

---

SQLite databases, by default, are stored on internal storage, accessible only to the app that creates them.

At least, that is the theory.

In practice, it is conceivable that others could get at an app's SQLite database, and that those "others" may not have the user's best interests at heart. Hence, if you are storing data in SQLite that should remain confidential despite extreme measures to steal the data, you may wish to consider encrypting the database.

Perhaps the simplest way to encrypt a SQLite database is to use [SQLCipher](#). SQLCipher is a SQLite extension that encrypts and decrypts database pages as they are written and read. However, SQLite extensions need to be compiled into SQLite, and the stock Android SQLite does not have the SQLCipher extension.

[SQLCipher for Android](#), therefore, comes in the form of a replacement implementation of SQLite that you add as an NDK library to your project. It also ships with replacement editions of the `android.database.sqlite.*` classes that use the SQLCipher library instead of the built-in SQLite. This way, your app can be largely oblivious to the actual database implementation, particularly if it is hidden behind a `ContentProvider` or similar abstraction layer.

SQLCipher for Android is a joint initiative of [Zetetic](#) (the creators of SQLCipher) and [the Guardian Project](#) (home of many privacy-enhancing projects for Android). SQLCipher for Android is open source, under the Apache License 2.0.

Many developers of enterprise-grade apps for Android (e.g., Salesforce.com, JPMorgan Chase) use SQLCipher for securing their apps.

## Prerequisites

Understanding this chapter requires that you have read the chapters on:

- [database access](#)
- [content provider theory](#)
- [content provider implementations](#)

## Scenarios for Encryption

So, why might you want to encrypt a database?

Some developers probably are thinking that this is a way of protecting the app's content against "those pesky rooted device users". In practice, this is unlikely to help. As with most encryption mechanisms, SQLCipher uses an encryption key. If the app has the key, such as being hard-coded into the app itself, anyone can get the key by reverse-engineering the app.

Rather, encrypted databases are to help the user defend their data against other people seeing it when they should not. The classic example is somebody leaving their phone in the back of a taxi — if that device winds up in the hands of some group with the skills to root the device, they can get at any unencrypted content they want. While some users will handle this via the whole-disk encryption available since Android 3.0, others might not.

If the database is going anywhere other than internal storage, there is all the more reason to consider encrypting it, as then it may not even require a rooted device to access the database. Scenarios here include:

1. Databases stored on external storage
2. Databases backed up using external storage, BackupManager, or another Internet-based solution
3. Databases explicitly being shared among a user's devices, or between a user's device and a desktop (note that SQLCipher works on many operating systems, including desktops and iOS)

## Obtaining SQLCipher

SQLCipher for Android is available from [its GitHub repository](#). The [downloads area](#) contains ZIP archives of what you need. As of December 2012, the current shipping version was 2.1.1.

## Employing SQLCipher

Given an existing Android project, to use SQLCipher for Android, you need to extract the contents of the ZIP archive's `libs/` directory and put them in your own project's `libs/` directory (creating the latter if needed). The ZIP archive's `libs/` directory contains a few JARs, plus a set of NDK-compiled C/C++ libraries for SQLite with the SQLCipher extension. Note that SQLCipher for Android 2.1.1 ships with NDK binaries for both ARM and x86; previous SQLCipher for Android distributions only supported ARM.

You will also need to copy the contents of the ZIP archive's `assets/` folder into your project's `assets/` folder (creating the latter if needed).

If you have existing code that uses classic Android SQLite, you will need to change your import statements to pick up the SQLCipher for Android equivalents of the classes. For example, you obtain `SQLiteDatabase` now from `net.sqlcipher.database.sqlcipher`, not `android.database.sqlite`. Similarly, you obtain `SQLException` from `net.sqlcipher.database` instead of `android.database`. Unfortunately, there is no complete list of which classes need this conversion — `Cursor`, for example, does not. Try converting everything from `android.database` and `android.database.sqlite`, and leave alone those that do not exist in the SQLCipher for Android equivalent packages.

Before starting to use SQLCipher for Android, you need to call `SQLiteDatabase.loadLibs()`, supplying a suitable `Context` object as a parameter. This initializes the necessary libraries. If you are using a `ContentProvider`, just call this in `onCreate()` before actually using anything else with your database. If you are not using a `ContentProvider`, you probably will want to create a custom subclass of `Application` and make this call from that class' `onCreate()`, and reference your custom `Application` class in the `android:name` attribute of the `<application>` element in your manifest. Either of these approaches will help ensure that the libraries are ready before you try doing anything with the database.

## ENCRYPTED STORAGE

---

Finally, when calling `getReadableDatabase()` or `getWritableDatabase()` on `SQLiteDatabase`, you need to supply the encryption key to use. This may be somewhat tricky with a `ContentProvider`, as there is not an obvious way for you to get the key to the provider in advance of accessing the database. On older versions of Android, you will probably wind up using a static data member — before trying to first use the database, get the encryption key (e.g., based on a password typed by the user), put it in a static data member, and have your `ContentProvider` read the value from there.

However, starting with API Level 11, there is another approach for interacting with a `ContentProvider` beyond the scope of the traditional `query()`, `insert()`, etc. methods, by means of the `call()` method. That is the approach taken in the [Database/ConstantsSecure](#) sample app, yet another variation of the `ConstantsBrowser`, but where the information is stored in a `SQLCipher` for Android database, to keep our precious gravitational constants away from those who might abuse them.

Our revised `Provider` class switches its imports to the ones needed by `SQLCipher` for Android:

```
import net.sqlcipher.SQLiteException;
import net.sqlcipher.database.SQLiteDatabase;
import net.sqlcipher.database.SQLiteQueryBuilder;
```

In `onCreate()`, it initializes the libraries before creating our `DatabaseHelper` (our `SQLiteOpenHelper` implementation):

```
@Override
public boolean onCreate() {
    SQLiteDatabase.loadLibs(getContext());
    db=(new DatabaseHelper(getContext()));

    return((db == null) ? false : true);
}
```

That `DatabaseHelper` is unchanged from previous editions, other than altering the imports to use `SQLCipher` for Android equivalents.

Back in our `ContentProvider`, the implementation of methods like `query()` then use a key data member in their calls to `getWritableDatabase()`:

```
@Override
public Cursor query(Uri url, String[] projection, String selection,
    String[] selectionArgs, String sort) {
    SQLiteQueryBuilder qb=new SQLiteQueryBuilder();
```

## ENCRYPTED STORAGE

---

```
qb.setTables(TABLE);

String orderBy;

if (TextUtils.isEmpty(sort)) {
    orderBy=Constants.DEFAULT_SORT_ORDER;
}
else {
    orderBy=sort;
}

Cursor c=
    qb.query(db.getReadableDatabase(key), projection, selection,
            selectionArgs, null, null, orderBy);

c.setNotificationUri(getContext().getContentResolver(), url);

return(c);
}
```

The key is set via the call() mechanism.

A client can call call() on a ContentProvider by means of a ContentResolver. call() takes the Uri of the ContentProvider, the name of the “method” to call, and an optional String argument and Bundle for additional parameters. For example, our ConstantsBrowser activity now uses call() to call a “method” on the Provider, supplying the encryption key (here hard-coded for simplicity):

```
getContentResolver().call(Provider.Constants.CONTENT_URI,
    Provider.SET_KEY_METHOD, "sekrit", null);
```

That call() routes to a call() implementation on the ContentProvider, which is supplied all of the parameters except the Uri. It is up to the ContentProvider to examine the “method” name and handle it accordingly, optionally returning a Bundle of return values. In the case of our Provider class, if the call is for setting the encryption key, and the supplied key is not null, we put it in the key data member:

```
@Override
public Bundle call(String method, String arg, Bundle extras) {
    if (SET_KEY_METHOD.equals(method) && arg != null) {
        key=arg;
    }

    return(null);
}
```



This way, we supply the encryption key to the `ContentProvider` before trying to use the database, while also avoiding a static data member. The downside of this approach, or pretty much anything involving `SQLCipher` for Android, is that we have to be very careful to ensure that we are routing the user through the login process before trying to use the database, no matter how they enter our app (launcher icon, recent tasks, app widget tap, started by a third-party app, etc.). While in this case, our hard-coded key avoids this complexity, it results in extremely weak security, as anyone could decompile the app, find the key, and decrypt the database. We will touch on keys and passwords more [later in this chapter](#).

Nothing else in the `ConstantsBrowser` activity needs to change, because the `ContentProvider` facade hides the rest of the implementation details.

## SQLCipher Limitations

Alas, `SQLCipher` for Android is not perfect.

It will add 2–3MB to the size of your APK file per CPU architecture. For most modern Android devices, this extra size will not be a huge issue, though it will be an impediment for older devices with less internal storage, or for apps that are getting close to the size limits imposed by the Play Store or other distribution mechanisms.

However, the size is mostly from code, and that may cause a problem for Eclipse users. Eclipse may crash with its own `OutOfMemoryError` during the final build process. To address that, find your `eclipse.ini` file (location varies by OS and installation method) and increase the `-Xmx` value shown on one of the lines (e.g., change it to `-Xmx512m`).

Other code that expects to be using native `SQLite` databases will require alteration to work with `SQLCipher` for Android databases. For example, the `SQLiteAssetHelper` described [elsewhere in this book](#) would need to be ported to use the `SQLCipher` for Android implementations of `SQLiteOpenHelper`, `SQLiteDatabase`, etc. This is not too difficult for an open source component like `SQLiteAssetHelper`.

## Passwords and Sessions

Given an encrypted database, there are several ways that an attacker can try to access the data, including:

1. Use a brute-force attack via the app itself
2. Use a brute-force attack on the database directly, by copying it to some other machine
3. Obtain the password by the strategic deployment of [a \\$5 wrench](#)

The classic way to prevent the first approach is by having business logic that prevents lots of failed login attempts in a short period of time. This can be built into your login dialog (or the equivalent), tracking the number and times of failed logins and introducing delays, forced app exits, or something to add time and hassle for trying lots of passwords.

Since manually trying passwords is nasty, brutish, and long, many attackers would automate the process by copying the SQLCipher database to another machine (e.g., desktop) and running a brute-force attack on it directly. SQLCipher for Android has many built-in protections to help defend against this. So long as you are using a sufficiently long and complex encryption key, you should be fairly well-protected against such attacks.

Defending against wrenches is decidedly more difficult and is beyond the scope of this book.

## About Those Passphrases...

Having a solid encryption algorithm, like the AES-256 used by default with SQLCipher for Android, is only half the battle. The other half is in using a high-quality passphrase, one that is unlikely to be guessed by anyone looking to break the encryption.

## Upgrading to Encryption

Suppose you have an app already out on the market, and you decide that you want to add the option for encryption. It is fairly likely that the user will be miffed if they lose all their data in the process of switching to an encrypted database. Therefore, you will want to try to retain their data.

SQLCipher for Android does not support in-place encryption of database. However, it *does* support working with unencrypted databases and encrypted databases simultaneously, giving you the option of migration.

The approach boils down to:

## ENCRYPTED STORAGE

---

- Open the unencrypted database in SQLCipher for Android, using an empty passphrase
- Use the ATTACH statement to open the encrypted database inside the same SQLCipher for Android session
- Use a supplied sqlcipher\_export() function to migrate most of the data
- Copy the Android database schema version between the databases
- DETACH the encrypted database
- Close the unencrypted database (and, presumably, delete it)
- Use the encrypted database from this point forward

Since both database files will exist at one time, you will find it simplest to use separate names for them (e.g., stuff.db and stuff-encrypted.db).

To see how this works, take a look at the [Database/SQLCipherPassphrase](#) sample app, which is a variation of the original, non-ContentProvider “constants” sample app, this time using SQLCipher for Android and supporting an upgrade from a non-encrypted database to an encrypted one.

The bulk of the logic for handling the encryption upgrade is in a static encrypt() method on our DatabaseHelper:

```
static void encrypt(Context ctxt) {
    SQLiteDatabase.loadLibs(ctxt);

    File dbFile=ctxt.getDatabasePath(DATABASE_NAME);
    File legacyFile=ctxt.getDatabasePath(LEGACY_DATABASE_NAME);

    if (!dbFile.exists() && legacyFile.exists()) {
        SQLiteDatabase db=
            SQLiteDatabase.openOrCreateDatabase(legacyFile, "", null);

        db.rawQuerySQL(String.format("ATTACH DATABASE '%s' AS encrypted KEY '%s';",
                                    dbFile.getAbsolutePath(), PASSPHRASE));
        db.rawQuerySQL("SELECT sqlcipher_export('encrypted')");
        db.rawQuerySQL("DETACH DATABASE encrypted;");

        int version=db.getVersion();

        db.close();

        db=SQLiteDatabase.openOrCreateDatabase(dbFile, PASSPHRASE, null);
        db.setVersion(version);

        legacyFile.delete();
    }
}
```

## ENCRYPTED STORAGE

---

First, we initialize SQLCipher for Android by calling `loadLibs()` on the SQLCipher version of `SQLiteDatabase`. We could do this someplace else, but for this sample, this is as good a spot as any.

We then create `File` objects pointing at the locations of the old, unencrypted database (with a name represented by a `LEGACY_DATABASE_NAME` static data member) and the new encrypted database (`DATABASE_NAME`). To get the `File` locations of those databases, we use `getDatabasePath()`, a method on `Context`, which returns the correct location for a database file given its name.

If the encrypted database exists, there is nothing that we need to do. Similarly, if it does not exist but the unencrypted database *also* does not exist, there is nothing that we *can* do. In either of those cases, we skip over the rest of the logic. In the first case, we already did the conversion (presumably); in the latter case, this is a new installation, and our `SQLiteOpenHelper` `onCreate()` logic will handle that. But, in the case where we do not have the encrypted database but do have the unencrypted one, we can create the encrypted database from the unencrypted data, which is what the bulk of the `encrypt()` method does.

To that, we:

- Use `openOrCreateDatabase()` to open the already-existing unencrypted database file *in SQLCipher for Android*, using "" as the passphrase.
- Use a `rawExecSQL()` method available on the SQLCipher for Android version of `SQLiteDatabase` to ATTACH the encrypted database, given its path, to our database session, using the supplied passphrase. This means that we can access the tables from both databases simultaneously, though we need to prefix all references to the attached database via its handle, `encrypted`.
- Use `rawExecSQL()` to execute `SELECT sqlcipher_export('encrypted')`, which copies most of our data from the unencrypted database (the database we have open) into the encrypted database (the one we attached). The big thing that `sqlcipher_export()` does *not* copy is the schema version number that Android maintains.
- Use `rawExecSQL()` to DETACH the attached encrypted database, as we no longer need it.
- Call `getVersion()` on the `SQLiteDatabase` representing the unencrypted database, to retrieve the schema version number that Android maintains.
- Close the unencrypted database and open the encrypted one using `openOrCreateDatabase()`.
- Use `setVersion()` on `SQLiteDatabase` to set the schema version of the encrypted database to the value we had from the unencrypted database.

## ENCRYPTED STORAGE

---

- Close the encrypted database and delete the unencrypted database file. Note that on API Level 16+, we could use the `deleteDatabase()` method on `SQLiteDatabase` to cleanly delete everything associated with SQLite.

The combination of doing all of that migrates our data from an unencrypted database to an encrypted one.

Then, we simply need to call `encrypt()` before we try loading our constants, from `doInBackground()` of our `LoadCursorTask`:

```
@Override
protected Void doInBackground(Void... params) {
    DatabaseHelper.encrypt(ctxt);
    constantsCursor=doQuery();
    constantsCursor.getCount();

    return(null);
}
```

To test this upgrade logic, you will need to:

- Run [the original unencrypted version of this sample](#), found in the [Database/Constants](#) sample application
- Add a new constant using the unencrypted version of the app
- Run the encrypted version of the sample from this section, which shares the same package name as the original and therefore will replace it on your emulator

You will see your added constant appear along with all of the standard ones, yet if you examine `/data/data/com.commonware.android.constants/databases` on your ARM emulator via DDMS, you will see that your database is now named `constants-crypt.db` instead of `constants.db`, as we have replaced the unencrypted database with an encrypted one.

## Changing Encryption Passphrases

Another thing the user might wish to do is change their passphrase. Perhaps they fear that their existing passphrase has been compromised (e.g., a narrow escape from a \$5 wrench). Perhaps they rotate their passphrases as a matter of course. Perhaps they simply keep typing in their current one incorrectly and want to switch to one they think they can enter more accurately.

SQLCipher for Android supports a rekey PRAGMA that can accomplish this. Given an open encrypted database `db` — opened using the old passphrase — you can change the password to a `newPassword` string variable via:

```
db.execSQL(String.format("PRAGMA rekey = '%s'", newPassword));
```

Note that this may take some time, as SQLCipher for Android needs to re-encrypt the entire database.

### Multi-Factor Authentication

Another way to effectively boost the strength of your security is to implement your own multi-factor authentication. In this case, the passphrase is not obtained solely through the user typing in the whole thing, but instead is synthesized from two or more sources. So, in addition to some `EditText` widget for entering in a portion of the passphrase, the rest could come from things like:

- A value written to an NFC tag that the user must tap
- A value encoded in a QR code that the user must scan
- A value obtained by some Bluetooth-connected device via a custom protocol

You, in code, would concatenate the pieces together, possibly using delimiters that cannot be typed in (e.g., ASCII characters below 32) to denote the sources of each segment of the passphrase. The result would be the actual passphrase you would use with SQLCipher for Android.

The objective is to make it easier for users to have more complex passphrases, while not having to type in something complex every time. Tapping an NFC tag is much faster than tapping out a passphrase on a typical phone keyboard, for example. Also, the “something you know and something you have” benefit of multi-factor authentication can help with defending against \$5 wrench attacks: if the NFC tag was destroyed, and the user never knew the portion of the passphrase stored on it, the user cannot divulge it.

Of course, this adds risks, such as the NFC tag being destroyed accidentally (e.g., “my dog ate it”). This can be mitigated in some cases by some “admin” being able to reset the password or supply a new NFC tag. In that case, getting the credentials requires *two* kidnappings and *two* \$5 wrenches (or the serial application of a single \$5 wrench, if budgets preclude buying two such wrenches), adding to the degree of difficulty for breaking the encryption by that means.

### Detecting Failed Logins

If you try to decrypt a database using the incorrect passphrase — whether an attempt by outsiders to use the app, or the user “fat-fingering” the passphrase and making a typo — you will get an exception:

```
11-19 09:17:22.700: E/SQLiteOpenHelper(1634):  
net.sqlcipher.database.SQLiteException: file is encrypted or is not a  
database
```

Alas, this is not a specific exception, making it a bit difficult to detect failed passphrases specifically. Your options are:

- Assume that your testing is sound and that exceptions when opening a database represent invalid passphrases, or
- Use a generic error message that hints at an invalid passphrase but leaves open the possibility of something else being wrong, or
- Read into the exception’s message looking for “file is encrypted or is not a database”, though this is fragile in the face of changes to SQLCipher for Android

### Encrypted Preferences

There are effectively three forms of data storage in Android:

- SQLite databases
- SharedPreferences
- Arbitrary files, in whatever format you want

You can encrypt SQLite via SQLCipher for Android, as seen in this chapter. You can encrypt arbitrary files as part of your data format, such as via `javax.crypto`.

What is not supported, out of the box, is a way to encrypt SharedPreferences.

There are two approaches for encrypting the contents of SharedPreferences:

1. Encrypt the container in which the SharedPreferences are stored
2. Encrypt each preference value as you store it in the SharedPreferences, and decrypt it when you read the value back out

### Encryption via Custom SharedPreferences

SharedPreferences is an interface. Hence, you can create other implementations of that interface that store their data in something other than unencrypted XML files.

CSharedPreferences is one such implementation. You can find it in the [cwac-prefs project on GitHub](#).

CSharedPreferences handles the SharedPreferences and SharedPreferences.Editor interfaces, along with the in-memory representations of the preferences. It then delegates the work of *storing* the preferences to a strategy object, implementing a strategy interface (CSharedPreferences.StorageStrategy). Two such strategy implementations are supplied in the project: one using ordinary SQLite, and one using SQLCipher for Android.

The basic recipe for using CSharedPreferences is:

- Create the strategy object, such as

```
new SQLCipherStrategy(getContext(), NAME, "atestpassword", LoadPolicy.SYNC)
```

(here, NAME is the name of the set of preferences, "atestpassword" is your passphrase, and LoadPolicy.SYNC indicates that the preferences should be loaded from disk immediately, not on a background thread)

- Create a CSharedPreferences that employs your chosen strategy:

```
new CSharedPreferences(yourStrategyObjectGoesHere);
```

- Use the CSharedPreferences as you would any other SharedPreferences implementation
- Call close() on the strategy object, to release any resources that it might hold (e.g., open database connection)

### Encryption via Custom Preference UI and Accessors

The big drawback to the custom SharedPreferences is the fact that you cannot get the PreferenceScreen system to work with it. The preference UI is hard-wired to use the stock implementation of SharedPreferences and does not appear to support any way to substitute in some other implementation.



## ENCRYPTED STORAGE

---

Hence, another approach is to keep things in standard `SharedPreferences`' XML files, but encrypt text values on a preference-by-preference basis. Since the data type needs to remain the same, most likely you would restrict this to encrypting strings (e.g., `EditTextPreference`, `ListPreference`) rather than numbers, booleans, etc.

To do this, you would need to:

- Implement static methods somewhere for your encryption and decryption algorithms
- Subclass the Preference classes of interest and override methods that would deal with the raw preference data, like `onDialogClosed()`, to encrypt the values you persist and decrypt the values you read in, using the static methods mentioned above
- Use your extended Preference classes in your preference XML as needed
- Use those static methods as part of reading (or writing) the preference values directly via `SharedPreferences`

The downsides to this approach include:

- Only certain preferences are encrypted, rather than all of them
- You lose some of the low-level encryption power of `SQLCipher` for Android, such as automatic hashing of passphrases, which you would have to handle yourself
- There may not be a library that supplies these extended Preference classes, forcing you to roll your own

## IOCipher

`SQLCipher` for Android is also used as the backing store for [IOCipher](#). `IOCipher` is a virtual file system (VFS) for Android, allowing you to write code that looks and works like it uses normal file I/O, yet all of the files are actually saved as BLOBs in a `SQLCipher` for Android database. The result is a fully-encrypted VFS, inheriting all of `SQLCipher`'s security features, such as default AES-256 encryption. This may be easier for you to use than encrypting and decrypting files individually via `javax.crypto`, for example.

`IOCipher` is considered to be in pre-alpha state as of November 2012.

# Tutorial: Upgrading to SQLCipher

---

This tutorial illustrates how to take an existing Android application and convert it to using SQLCipher for Android. While the app — a password “box” – is not terribly sophisticated, it does illustrate how to handle the three major scenarios:

- The user newly installs the encrypted version of your app, then runs it
- The user installs the encrypted version of your app as a replacement for the unencrypted version of your app, then runs it
- The user runs the encrypted version of your app for the second and subsequent times

This tutorial is not part of the EmPubLite tutorial series, but rather stands alone.

## Prerequisites

This tutorial assumes that you have read [the preceding chapter, on SQLCipher for Android](#), plus the rest of the core chapters of the book. Also, this tutorial uses [the Loader framework](#).

This tutorial also is reasonably advanced. It is expected that you will have a decent amount of Android development experience and know how to load projects into your IDE of choice, add import statements for Java classes, how to attach Android library projects to your own, and the like.

## Step #1: Getting Your Starting Point

First, you need the project that we will use as the starting point for this tutorial. If you have downloaded all the source for this book, you will find our starting point in

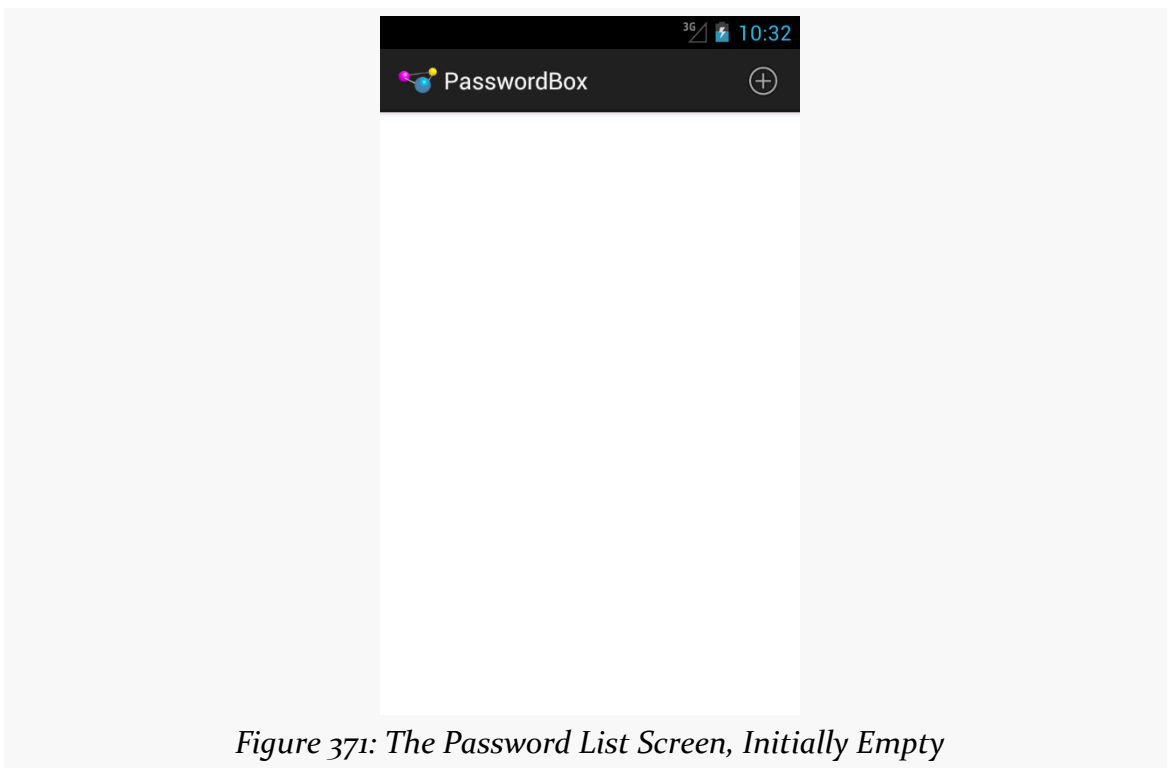
## TUTORIAL: UPGRADING TO SQLCIPHER

---

the [Database/PasswordBox-Start](#) sample project. Or, you can download a ZIP file of just Password-Start from [the downloads area of this book's GitHub repo](#).

You will want to get this project set up in your development environment. You will need to add a reference to the ActionBarSherlock Android library project, either a copy you already have, one [from the book's source code](#), or one you download from [the ActionBarSherlock Web site](#).

When you run the app, you will be first greeted with an empty display, except for an action bar:

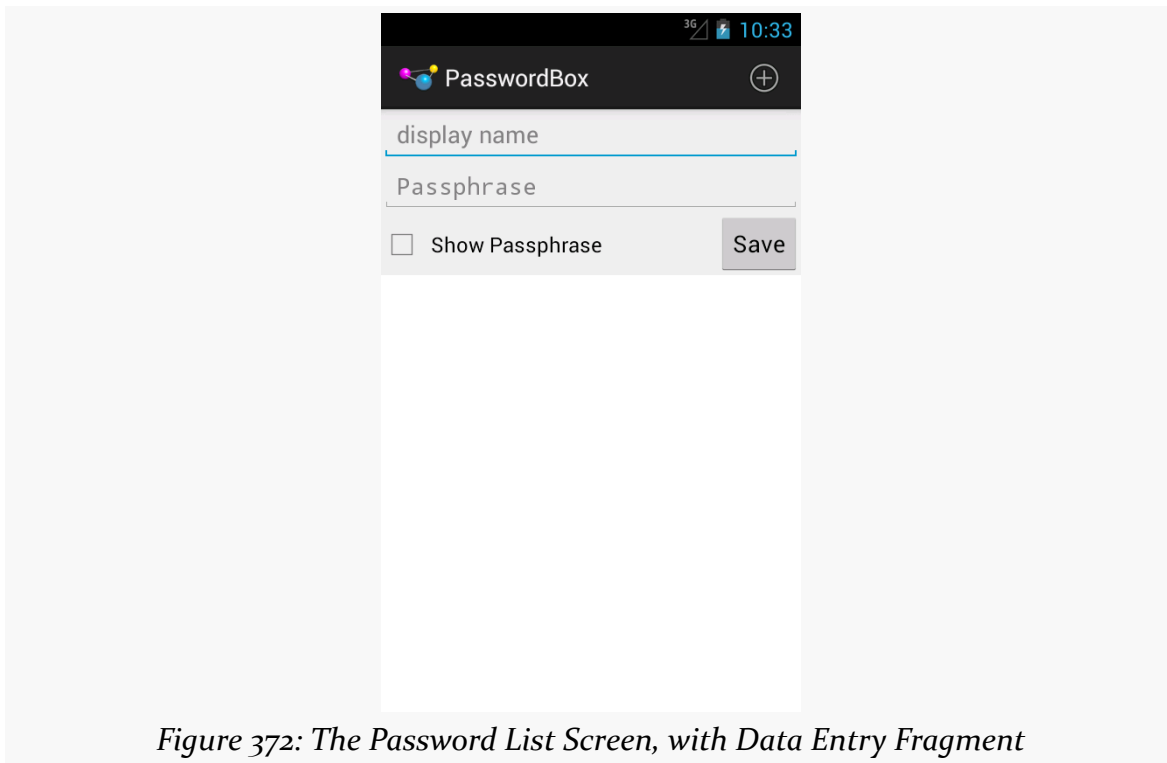


*Figure 371: The Password List Screen, Initially Empty*

Tapping on the + action bar item will expose a small form for you to fill in a new password to save in our “password box”:

## TUTORIAL: UPGRADING TO SQLCIPHER

---

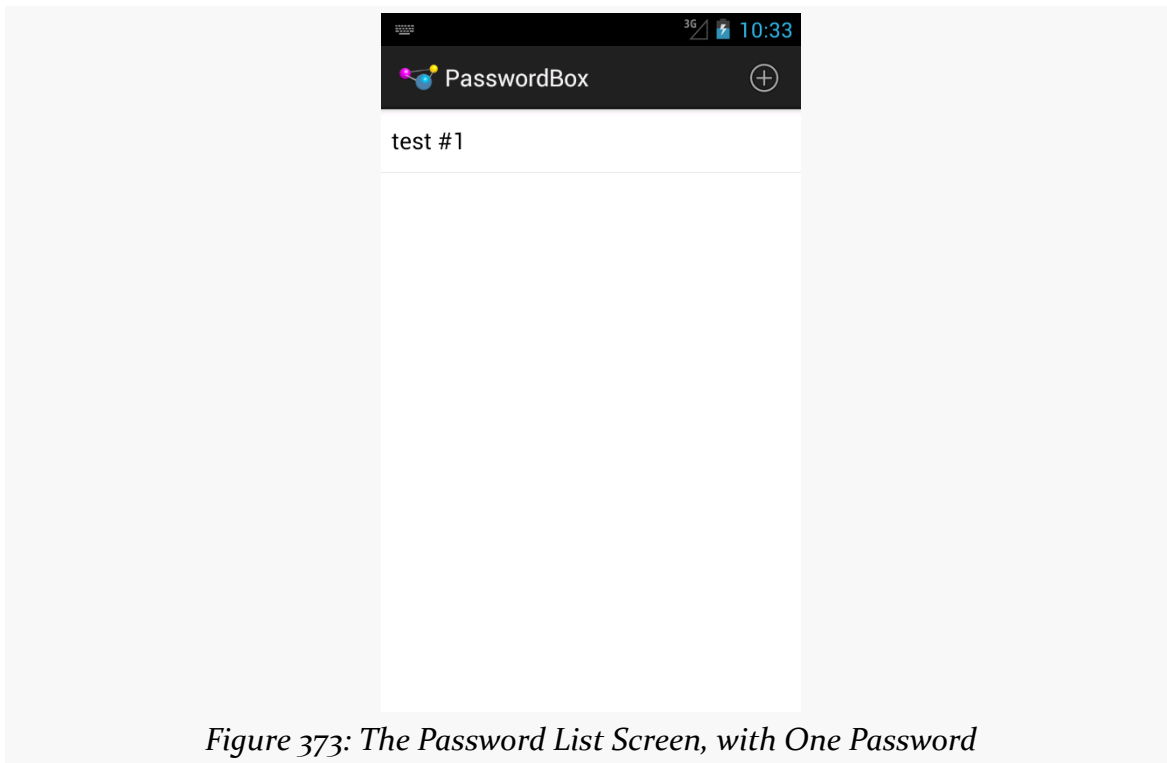


*Figure 372: The Password List Screen, with Data Entry Fragment*

Clicking the Save button will dismiss the form, and you will see your new entry in the list:

## TUTORIAL: UPGRADING TO SQLCIPHER

---



*Figure 373: The Password List Screen, with One Password*

Clicking on an item in the list brings it up again in the form, for edits:

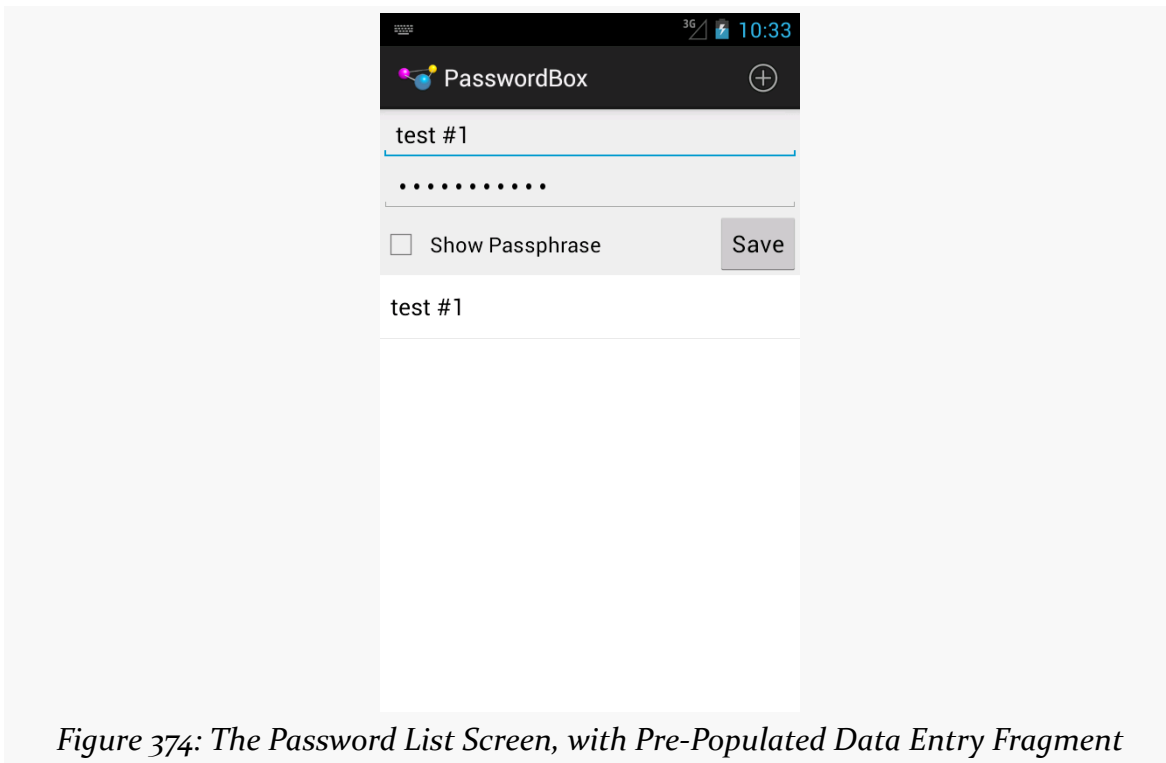


Figure 374: The Password List Screen, with Pre-Populated Data Entry Fragment

This version of the app has four classes. We start with MainActivity, our (current) entry point into the app. It loads up the activity\_main layout resource:

```
<LinearLayout xmlns:android="http://schemas.android.com/apk/res/android"
    xmlns:tools="http://schemas.android.com/tools"
    android:layout_width="fill_parent"
    android:layout_height="fill_parent"
    android:orientation="vertical">

    <FrameLayout
        android:id="@+id/passphrase"
        android:layout_width="match_parent"
        android:layout_height="wrap_content"/>

    <fragment
        android:id="@+id/roster"
        android:name="com.commonware.android.passwordbox.RosterFragment"
        android:layout_width="match_parent"
        android:layout_height="0dip"
        android:layout_weight="1"/>

</LinearLayout>
```

MainActivity loads up those layouts and gets access to our two fragments in onCreate():

## TUTORIAL: UPGRADING TO SQLCIPHER

---

```
@Override
protected void onCreate(Bundle savedInstanceState) {
    super.onCreate(savedInstanceState);
    setContentView(R.layout.activity_main);

    passphrase=
(PassphraseFragment)getSupportFragmentManager().findFragmentById(R.id.passphrase);
    roster=
(RosterFragment)getSupportFragmentManager().findFragmentById(R.id.roster);
}
```

The RosterFragment is responsible for displaying the list of passwords:

```
package com.commonware.android.passwordbox;

import android.content.ContentValues;
import android.database.Cursor;
import android.os.Bundle;
import android.support.v4.app.LoaderManager;
import android.support.v4.content.Loader;
import android.support.v4.widget.CursorAdapter;
import android.support.v4.widget.SimpleCursorAdapter;
import android.view.View;
import android.widget.ListView;
import com.actionbarsherlock.app.SherlockListFragment;
import com.actionbarsherlock.view.Menu;
import com.actionbarsherlock.view.MenuInflater;
import com.actionbarsherlock.view.MenuItem;
import com.commonware.cwac.loaderex.acl.SQLiteCursorLoader;

public class RosterFragment extends SherlockListFragment implements
    LoaderManager.LoaderCallbacks<Cursor> {
    private SQLiteCursorLoader loader=null;
    private DatabaseHelper db=null;

    @Override
    public void onActivityCreated(Bundle savedInstanceState) {
        super.onActivityCreated(savedInstanceState);

        setListAdapter(new SimpleCursorAdapter(
            getActivity(),
            android.R.layout.simple_list_item_1,
            null,
            new String[] { DatabaseHelper.TITLE },
            new int[] { android.R.id.text1 },
            0));

        db=new DatabaseHelper(getActivity());
        getLoaderManager().initLoader(0, null, this);

        Loader<Cursor> genericCastsSuck=getLoaderManager().getLoader(0);
```

## TUTORIAL: UPGRADING TO SQLCIPHER

---

```
        loader=(SQLiteCursorLoader)genericCastsSuck;

        setHasOptionsMenu(true);
    }

    @Override
    public void onDestroy() {
        Cursor c=((CursorAdapter)getListAdapter()).getCursor();

        if (c != null) {
            c.close();
        }

        super.onDestroy();
    }

    @Override
    public void onCreateOptionsMenu(Menu menu, MenuInflater inflater) {
        inflater.inflate(R.menu.roster, menu);

        super.onCreateOptionsMenu(menu, inflater);
    }

    @Override
    public boolean onOptionsItemSelected(MenuItem item) {
        if (item.getItemId() == R.id.add) {
            getActivityContract().showPassphrase();

            return(true);
        }

        return(super.onOptionsItemSelected(item));
    }

    @Override
    public Loader<Cursor> onCreateLoader(int loaderId, Bundle args) {
        loader=db.buildSelectAllLoader(getActivity());

        return(loader);
    }

    @Override
    public void onLoadFinished(Loader<Cursor> loader, Cursor cursor) {
        ((CursorAdapter)getListAdapter()).changeCursor(cursor);
    }

    @Override
    public void onLoaderReset(Loader<Cursor> loader) {
        ((CursorAdapter)getListAdapter()).changeCursor(null);
    }

    @Override
    public void onItemClick(AdapterView l, View v, int position, long id) {
```



## TUTORIAL: UPGRADING TO SQLCIPHER

---

```
Cursor c=((CursorAdapter)getListAdapter()).getCursor();
c.moveToPosition(position);
getActivityContract().showPassphrase(c.getInt(DatabaseHelper.SELECT_ALL_ID),
c.getString(DatabaseHelper.SELECT_ALL_TITLE),
c.getString(DatabaseHelper.SELECT_ALL_PASSPHRASE));
}

void savePassphrase(int id, String title, String passphrase) {
    ContentValues values=new ContentValues(2);

    values.put(DatabaseHelper.TITLE, title);
    values.put(DatabaseHelper.PASSPHRASE, passphrase);

    if (id == -1) {
        loader.insert(DatabaseHelper.TABLE, DatabaseHelper.TITLE, values);
    }
    else {
        String[] args= { String.valueOf(id) };

        loader.update(DatabaseHelper.TABLE, values, DatabaseHelper.ID
            + "=?", args);
    }
}

private MainActivity getActivityContract() {
    return((MainActivity)getActivity());
}
}
```

RosterFragment uses [a SQLiteCursorLoader](#) to show the list of defined passwords, and therefore the fragment implements LoaderCallbacks<Cursor> and populates a SimpleCursorAdapter for the results. It also contributes the + item to the action bar, delegating the work to the implementation of showPassphrase() on MainActivity. RosterFragment also calls a different version of showPassphrase() when an item is clicked upon in the list.

The zero-argument showPassphrase() will display a PassphraseFragment, clearing the current contents of the fields if we are reusing an existing instance of the fragment:

```
void showPassphrase() {
    boolean needsClear=false;

    if (passphrase == null) {
        passphrase=new PassphraseFragment();
    }
}
```

## TUTORIAL: UPGRADING TO SQLCIPHER

---

```
else {
    needsClear=true;
}

if (!passphrase.isVisible()) {
    getSupportFragmentManager().beginTransaction()
        .addToBackStack(null)
        .replace(R.id.passphrase, passphrase)
        .commit();
}

if (needsClear) {
    findViewById(android.R.id.content).post(new Runnable() {
        public void run() {
            passphrase.clear();
        }
    });
}
}
```

The three-argument `showPassphrase()` chains to the zero-argument one to display the fragment, then tells that fragment to `populate()` itself based upon a supplied database entry:

```
void showPassphrase(final int id, final String _title,
                    final String _passphrase) {
    showPassphrase();

    findViewById(android.R.id.content).post(new Runnable() {
        public void run() {
            passphrase.populate(id, _title, _passphrase);
        }
    });
}
```

`PassphraseFragment` is mostly involved in showing an existing passphrase (allowing edits) or defining a new passphrase:

```
package com.commonware.android.passwordbox;

import android.os.Bundle;
import android.text.method.PasswordTransformationMethod;
import android.view.LayoutInflater;
import android.view.View;
import android.view.View.OnClickListener;
import android.view.ViewGroup;
import android.widget.CompoundButton;
import android.widget.CompoundButton.OnCheckedChangeListener;
import android.widget.EditText;
import com.actionbarsherlock.app.SherlockFragment;

public class PassphraseFragment extends SherlockFragment implements
```

## TUTORIAL: UPGRADING TO SQLCIPHER

---

```
    OnClickListener, OnCheckedChangeListener {
private EditText passphrase=null;
private EditText title=null;
private int id=-1;

@Override
public View onCreateView(LayoutInflater inflater,
                        ViewGroup container,
                        Bundle savedInstanceState) {
    View result=inflater.inflate(R.layout.passphrase, container, false);

    result.findViewById(R.id.save).setOnClickListener(this);
    title=(EditText)result.findViewById(R.id.title);
    passphrase=(EditText)result.findViewById(R.id.passphrase);

    CompoundButton cb=
        (CompoundButton)result.findViewById(R.id.show_passphrase);

    cb.setOnCheckedChangeListener(this);

    return(result);
}

@Override
public void onClick(View v) {
    getActivityContract().savePassphrase(id,
                                        title.getText().toString(),
                                        passphrase.getText()
                                        .toString());
}

@Override
public void onCheckedChanged(CompoundButton cb, boolean isChecked) {
    int start=passphrase.getSelectionStart();
    int end=passphrase.getSelectionEnd();

    if (isChecked) {
        passphrase.setTransformationMethod(null);
    }
    else {
        passphrase.setTransformationMethod(new PasswordTransformationMethod());
    }

    passphrase.setSelection(start, end);
}

void populate(int id, String _title, String _passphrase) {
    this.id=id;
    title.setText(_title);
    passphrase.setText(_passphrase);
}

void clear() {
    id=-1;
}
```

## TUTORIAL: UPGRADING TO SQLCIPHER

---

```
    title.setText("");
    passphrase.setText("");
}

private MainActivity getActivityContract() {
    return((MainActivity)getActivity());
}
}
```

The UI for PassphraseFragment has two versions, one for -sw600dp devices in res/layout-sw600dp/passphrase.xml:

```
<LinearLayout xmlns:android="http://schemas.android.com/apk/res/android"
    android:layout_width="fill_parent"
    android:layout_height="wrap_content"
    android:background="@color/passphrase_bg"
    android:orientation="horizontal">

    <EditText
        android:id="@+id/title"
        android:layout_width="0dip"
        android:layout_height="wrap_content"
        android:layout_weight="1"
        android:hint="@string/name">

        <requestFocus/>
    </EditText>

    <EditText
        android:id="@+id/passphrase"
        android:layout_width="0dip"
        android:layout_height="wrap_content"
        android:layout_weight="1"
        android:hint="@string/passphrase"
        android:inputType="textPassword"/>

    <CheckBox
        android:id="@+id/show_passphrase"
        android:layout_width="wrap_content"
        android:layout_height="wrap_content"
        android:text="@string/show_passphrase"/>

    <Button
        android:id="@+id/save"
        android:layout_width="wrap_content"
        android:layout_height="wrap_content"
        android:text="@string/save"/>

</LinearLayout>
```

...and one for smaller screens in res/layout/passphrase.xml:

## TUTORIAL: UPGRADING TO SQLCIPHER

---

```
<LinearLayout xmlns:android="http://schemas.android.com/apk/res/android"
    android:layout_width="fill_parent"
    android:layout_height="wrap_content"
    android:background="@color/passphrase_bg"
    android:orientation="vertical">

    <EditText
        android:id="@+id/title"
        android:layout_width="match_parent"
        android:layout_height="wrap_content"
        android:ems="10"
        android:hint="@string/name">

        <requestFocus/>
    </EditText>

    <EditText
        android:id="@+id/passphrase"
        android:layout_width="match_parent"
        android:layout_height="wrap_content"
        android:ems="10"
        android:hint="@string/passphrase"
        android:inputType="textPassword"/>

    <LinearLayout
        android:layout_width="match_parent"
        android:layout_height="wrap_content">

        <CheckBox
            android:id="@+id/show_passphrase"
            android:layout_width="0dip"
            android:layout_height="wrap_content"
            android:layout_weight="1"
            android:text="@string/show_passphrase"/>

        <Button
            android:id="@+id/save"
            android:layout_width="wrap_content"
            android:layout_height="wrap_content"
            android:text="@string/save"/>
    </LinearLayout>
</LinearLayout>
```

If the user clicks the button in the fragment, control goes to `savePassphrase()` on `MainActivity`:

```
void savePassphrase(int id, String title, String passphrase) {
    roster.savePassphrase(id, title, passphrase);
    getSupportFragmentManager().popBackStack();
}
```

## TUTORIAL: UPGRADING TO SQLCIPHER

---

This in turn routes back to the RosterFragment, so we can use the SQLiteCursorLoader to update the database and refresh the list.

The SQLiteCursorLoader itself comes from DatabaseHelper, our SQLiteOpenHelper implementation:

```
package com.commonware.android.passwordbox;

import android.content.Context;
import android.database.sqlite.SQLiteDatabase;
import android.database.sqlite.SQLiteOpenHelper;
import com.commonware.cwac.loaderex.acl.SQLiteCursorLoader;

public class DatabaseHelper extends SQLiteOpenHelper {
    private static final String DATABASE_NAME="passwordbox.db";
    private static final int SCHEMA=1;
    static final String ID="_id";
    static final String TITLE="title";
    static final String PASSPHRASE="passphrase";
    static final int SELECT_ALL_ID=0;
    static final int SELECT_ALL_TITLE=1;
    static final int SELECT_ALL_PASSPHRASE=2;
    static final String TABLE="roster";

    public DatabaseHelper(Context context) {
        super(context, DATABASE_NAME, null, SCHEMA);
    }

    @Override
    public void onCreate(SQLiteDatabase db) {
        db.execSQL("CREATE TABLE roster (_id INTEGER PRIMARY KEY AUTOINCREMENT,
title TEXT, passphrase TEXT);");
    }

    @Override
    public void onUpgrade(SQLiteDatabase db, int oldVersion,
        int newVersion) {
        throw new RuntimeException("How did we get here?");
    }

    SQLiteCursorLoader buildSelectAllLoader(Context ctxt) {
        return(new SQLiteCursorLoader(
            ctxt,
            this,
            "SELECT _id, title, passphrase FROM roster
ORDER BY title",
            null));
    }
}
```

Specifically, the `buildSelectAllLoader()` returns a `SQLiteCursorLoader` set up to return the entire contents of the roster table, sorted by title.

Once you have this project working, save off a copy of the APK file, or clone the project in your IDE, so you can run both the old and new editions as you see fit.

## Step #2: Adding SQLCipher for Android

Now we need to add some third-party code to allow us to use encrypted databases.

First, we need to add a copy of SQLCipher for Android. The simplest solution is to download [the official binaries](#) (version 2.1.1 is recommended for this tutorial). You are also welcome to build the library [from source](#), if you prefer.

Assuming that you downloaded the official binaries, you will want to:

- Copy the contents of the library's `assets/` directory into your project's `assets/` directory, and
- Copy the contents of the library's `libs/` directory into your project's `libs/` directory

Eclipse users can drag-and-drop into the IDE itself. Eclipse users electing to make these changes directly in the file system should use the F5 key to update Eclipse, letting it know about the new files.

Note that your starting-point project already has one third-party library: the JAR file for the CWAC LoaderEx project, to give us a version of the Loader framework that will work with SQLCipher for Android, along with some related utility methods.

At this point, if you run your app, it should behave as before, because while we have added a bunch of library code, we are not actually using it anywhere. However, take some time to add one or more passwords to the app, so that we can confirm later on that encrypting our existing database worked (i.e., it retained our existing data).

## Step #3: Adding a New Launcher Activity

Our list-the-passwords UI now needs to be behind some sort of authentication UI, to allow the user to supply the master password for our “password box”.

If you wish to make this change using Eclipse's wizards and tools, follow the instructions in the "Eclipse" section below. Otherwise, follow the instructions in the "Outside of Eclipse" section (appears after the "Eclipse" section).

### Eclipse

Right click over the `com.commonware.android.passwordbox` package in the `src/` folder of your project, and choose `New > Class` from the context menu. Fill in `AuthActivity` in the "Name" field. Click the "Browse..." button next to the "Superclass" field and find `SherlockFragmentActivity` to set as the superclass. Then, click "Finish" on the new-class dialog to create the `AuthActivity` class.

Then, open up the `AndroidManifest.xml` file. Using the Application tab, add a new entry in the "Application Nodes" for `AuthActivity` (click the `Add...` button, choose `Activity` from the list, then click the `Browse...` button to the right of the name field and choose `AuthActivity`).

Next, click over to the `AndroidManifest.xml` sub-tab and move the `<intent-filter>` element from `MainActivity` to `AuthActivity`, to make `AuthActivity` be the launcher activity.

After saving your changes, run the app in your device or emulator — you should get a blank UI, as we have not put any code into `AuthActivity` just yet.

### Outside of Eclipse

Create a `src/com/commonware/android/passwordbox/AuthActivity.java` source file with the following contents:

```
package com.commonware.android.passwordbox;

import com.actionbarsherlock.app.SherlockFragmentActivity;

public class AuthActivity extends SherlockFragmentActivity {

}
```

Then, add a corresponding `<activity>` element to your manifest, pointing to `AuthActivity`, and move the `<intent-filter>` from `MainActivity` to `AuthActivity`. Your manifest file should then resemble the following:

```
<?xml version="1.0" encoding="utf-8"?>
<manifest xmlns:android="http://schemas.android.com/apk/res/android"
```



```
package="com.commonware.android.passwordbox"
android:versionCode="1"
android:versionName="1.0" xmlns:tools="http://schemas.android.com/tools">

<uses-sdk
    android:minSdkVersion="7"
    android:targetSdkVersion="16"
    tools:ignore="OldTargetApi"/>

<application
    android:allowBackup="true"
    android:icon="@drawable/ic_launcher"
    android:label="@string/app_name"
    android:theme="@style/Theme.Sherlock.Light.DarkActionBar">
    <activity
        android:name="com.commonware.android.passwordbox.MainActivity"
        android:label="@string/app_name">
    </activity>
    <activity
        android:name="com.commonware.android.passwordbox.AuthActivity"
        android:label="@string/app_name">
        <intent-filter>
            <action android:name="android.intent.action.MAIN"/>

            <category android:name="android.intent.category.LAUNCHER"/>
        </intent-filter>
    </activity>
</application>

</manifest>
```

After saving your changes, run the app in your device or emulator — you should get a blank UI, as we have not put any code into AuthActivity just yet.

## Step #4: Collect Passphrase For New Encryption

Now we need to set up the basic UI for collecting a passphrase from the user. There are three scenarios that we need to consider for this:

1. The user is running the app for the very first time on a new installation of the app, so we need the passphrase to use with a new empty encrypted database
2. The user is running the app for the first time after an upgrade from the unencrypted version of the app, so we need the passphrase to use to encrypt the existing data
3. The user is running the app with an already-encrypted database, in which case we need the passphrase to decrypt the database

With that in mind, let us start setting up the UI.

First, we need a layout XML resource file, `res/layout/passphrase_setup.xml`, with:

- an `EditText` named `passphrase`, set up for an `android:inputType` of `textPassword`
- another `EditText`, named `confirm`, also set up for an `android:inputType` of `textPassword`
- some type of `CompoundButton`, like a `CheckBox`, named `show_passphrase`, initially unchecked
- a `Button`, named `ok`, that is initially disabled (`android:enabled="false"`)

For example, you could design a layout like this:

```
<LinearLayout xmlns:android="http://schemas.android.com/apk/res/android"
    android:layout_width="fill_parent"
    android:layout_height="wrap_content"
    android:layout_gravity="center_vertical"
    android:orientation="vertical">

    <EditText
        android:id="@+id/passphrase"
        android:layout_width="match_parent"
        android:layout_height="wrap_content"
        android:ems="10"
        android:hint="@string/passphrase"
        android:inputType="textPassword">

        <requestFocus/>
    </EditText>

    <EditText
        android:id="@+id/confirm"
        android:layout_width="match_parent"
        android:layout_height="wrap_content"
        android:ems="10"
        android:hint="@string/confirm"
        android:inputType="textPassword" />

    <LinearLayout
        android:layout_width="match_parent"
        android:layout_height="wrap_content">

        <CheckBox
            android:id="@+id/show_passphrase"
            android:layout_width="0dip"
            android:layout_height="wrap_content"
            android:layout_weight="1"
            android:text="@string/show_passphrase" />
```

```
<Button
    android:id="@+id/ok"
    android:layout_width="wrap_content"
    android:layout_height="wrap_content"
    android:enabled="false"
    android:text="@string/ok" />
</LinearLayout>
</LinearLayout>
```

This is great for the case where we need a new passphrase for a new (or newly-encrypted database). Later on, we will hide the confirm EditText widget when we know that we have an existing database and do not need the user to confirm the entered passphrase for accuracy.

You will also need the corresponding string resources for your widgets, such as:

```
<string name="confirm">confirm</string>
<string name="ok">OK</string>
```

After creating that layout XML resource, add the following data members (and necessary imports) to AuthActivity:

```
private EditText passphrase=null;
private EditText confirm=null;
private View ok=null;
```

This simply defines data members for all of the widgets (except the CompoundButton).

Then, add the following implementation of the onCreate() method (along with all necessary imports):

```
@Override
public void onCreate(Bundle savedInstanceState) {
    super.onCreate(savedInstanceState);
    setContentView(R.layout.passphrase_setup);

    passphrase=(EditText)findViewById(R.id.passphrase);
    confirm=(EditText)findViewById(R.id.confirm);

    passphrase.addTextChangedListener(this);
    confirm.addTextChangedListener(this);

    CompoundButton cb=
        (CompoundButton)findViewById(R.id.show_passphrase);

    cb.setOnCheckedChangeListener(this);
}
```

## TUTORIAL: UPGRADING TO SQLCIPHER

---

```
ok=findViewById(R.id.ok);
ok.setOnClickListener(this);
}
```

This loads our layout resource, finds our various widgets, and sets up the activity to handle three types of events:

1. Changes in the text entered into the EditText widgets
2. Changes in the checked state of the CompoundButton
3. Clicks on the Button

To make all of that work, you will need to have AuthActivity implement the corresponding TextWatcher, OnCheckedChangeListener, and OnClickListener interfaces.

To satisfy the requirements of the OnClickListener interface, add an empty onClick() method to AuthActivity:

```
@Override
public void onClick(View v) {
}
```

For the TextWatcher interface, add the following three methods (along with all necessary imports) to AuthActivity:

```
@Override
public void afterTextChanged(Editable s) {
    ok.setEnabled(passphrase.getText().length() > 0
        && passphrase
            .getText()
            .toString().equals(confirm.getText().toString()));
}

@Override
public void beforeTextChanged(CharSequence s, int start, int count,
    int after) {
    // unused
}

@Override
public void onTextChanged(CharSequence s, int start, int before,
    int count) {
    // unused
}
```

Here, we will enable the OK button if and only if:

## TUTORIAL: UPGRADING TO SQLCIPHER

---

- The two EditText widgets have the same content, and
- That content is not the empty string

Finally, to handle our OnCheckedChangeListener interface, add the following two methods to AuthActivity (along with all necessary imports):

```
@Override
public void onCheckedChanged(CompoundButton buttonView,
                             boolean isChecked) {
    toggleShowPassphrase(passphrase, isChecked);
    toggleShowPassphrase(confirm, isChecked);
}

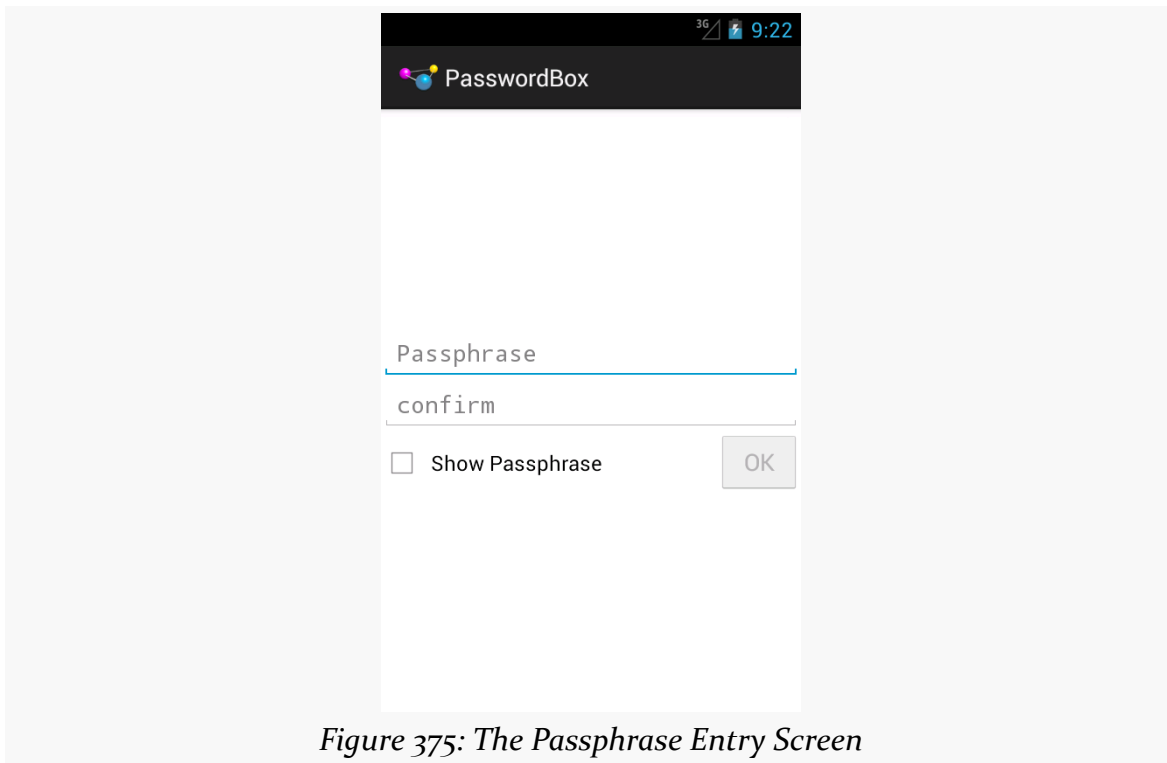
private void toggleShowPassphrase(EditText field, boolean isChecked) {
    int start=field.getSelectionStart();
    int end=field.getSelectionEnd();

    if (isChecked) {
        field.setTransformationMethod(null);
    }
    else {
        field.setTransformationMethod(new PasswordTransformationMethod());
    }

    field.setSelection(start, end);
}
```

Here, when the user toggles the CompoundButton, we toggle whether or not the EditText widgets should show or shroud the actual passphrases themselves. setTransformationMethod(null) removes the shrouding effect, while setTransformationMethod(new PasswordTransformationMethod()) adds it. We also retain the selection range, if any, so tapping that CompoundButton does not change that inadvertently.

At this point, run your revised app. You should see your passphrase entry UI – the one based on the above layout resource will look like:



The OK button should enable or disable based upon the entered passphrases, and the CompoundButton should toggle the display style of the EditText widgets.

### Step #5: Create or Encrypt the Database

Now, we can start blending in SQLCipher for Android logic, with the help of some support methods from the LoaderEx project.

First, add the following line to the onCreate() method of AuthActivity, after the setContentView() call, along with the import for the SQLCipher edition of SQLiteDatabase:

```
SQLiteDatabase.loadLibs(this);
```

This is necessary before we attempt to use SQLCipher for Android, to set up the NDK-compiled JNI libraries and ready SQLCipher for Android for use.

Next, add the following data member to AuthActivity:

```
private State dbState=State.UNKNOWN;
```

## TUTORIAL: UPGRADING TO SQLCIPHER

---

Here, State is `com.commonware.cwac.loaderex.SQLCipherUtils.State`, which you will need to add as an import. This is from some utility code supplied by the LoaderEx project. State can have four possible values:

- `DOES_NOT_EXIST`, meaning that we cannot find a database file
- `UNENCRYPTED`, meaning that we have found a database file and believe that it is unencrypted
- `ENCRYPTED`, meaning that we have found a database file and believe that it is encrypted, and
- `UNKNOWN`, meaning that we do not know what is going on with the database

Initially, because we have not looked, we have our state set to `UNKNOWN`.

Next, add the following line to `onCreate()` of `AuthActivity`, just after the `loadLibs()` call you added moments ago:

```
dbState=DatabaseHelper.getDatabaseState(AuthActivity.this);
```

This refers to a non-existent static `getDatabaseState()` method on our `DatabaseHelper` class, which we need to add:

```
static State getDatabaseState(Context context) {  
    return(SQLCipherUtils.getDatabaseState(context, DATABASE_NAME));  
}
```

This simply calls the static `getDatabaseState()` method on a `SQLCipherUtils` class (which you will need to add as an import), to find out what the current state of our database is, given its name.

Then, replace the empty `onClick()` implementation in `AuthActivity` with the following:

```
@Override  
public void onClick(View v) {  
    v.setEnabled(false);  
  
    if (dbState == State.UNENCRYPTED) {  
        try {  
            DatabaseHelper.encrypt(this, passphrase.getText().toString());  
        }  
        catch (IOException e) {  
            Toast.makeText(this,  
                getString(R.string.problem_encrypting_database)  
                    + e.getLocalizedMessage(), Toast.LENGTH_LONG)  
                .show();  
            finish();  
        }  
    }  
}
```

## TUTORIAL: UPGRADING TO SQLCIPHER

---

```
        return;
    }
}

DatabaseHelper.initDatabase(this, passphrase.getText().toString());

startActivity(new Intent(this, MainActivity.class));
finish();
}
```

Here, what we are trying to do is:

- Encrypt the database if it exists but is unencrypted
- Initialize our database regardless of whether it was encrypted, was unencrypted, or needs to be created from scratch
- Launches MainActivity to show the contents of that database

You will need to add a string resource for `problem_encrypting_database`, used in the Toast that is displayed if there is a problem encrypting the database:

```
<string name="problem_encrypting_database">Problem encrypting
database:</string>
```

We also need to add two more static methods to DatabaseHelper that our `onClick()` method is attempting to call. First, add the following implementation of `encrypt()` to DatabaseHelper:

```
static void encrypt(Context ctxt, String passphrase)
    throws IOException {
    SQLCipherUtils.encrypt(ctxt, DATABASE_NAME, passphrase);
}
```

As with `getDatabaseState()`, this simply calls the corresponding `encrypt()` method on `SQLCipherUtils`, which will encrypt the existing database.

Then, add the following data member to DatabaseHelper:

```
private static volatile SQLiteDatabase singleton=null;
```

This defines a static `SQLiteDatabase` singleton that we will use for common access from both `AuthActivity` and `MainActivity`. We set up that singleton in an `initDatabase()` method, which you should add to DatabaseHelper:

```
synchronized static SQLiteDatabase initDatabase(Context context,
    String passphrase) {
    if (singleton == null) {
```



## TUTORIAL: UPGRADING TO SQLCIPHER

---

```
        singleton=
            new
DatabaseHelper(context.getApplicationContext()).getWritableDatabase(passphrase);
    }

    return(singleton);
}
```

This initializes the SQLiteDatabase singleton with a writable database. We use `getApplicationContext()` to ensure that our singleton, at most, holds onto a reference to the global Application Context, rather than an activity, to avoid potential memory leaks.

This code will have an error, because `getWritableDatabase()` does not take a string parameter... for the normal `SQLiteOpenHelper` class. We need to switch to the `SQLCipher` for Android version of `SQLiteOpenHelper`. To do this, simply replace the imports for `SQLiteDatabase` and `SQLiteOpenHelper` to:

```
import net.sqlcipher.database.SQLiteDatabase;
import net.sqlcipher.database.SQLiteOpenHelper;
```

This will trigger lots of source errors, which we will fix later in this tutorial.

Let us also go ahead and provide a getter method for the `SQLiteDatabase` singleton, as another method on `DatabaseHelper`:

```
    synchronized static SQLiteDatabase getDatabase() {
        return(singleton);
    }
```

You might wonder why we are not simply lazy-initializing our `SQLiteDatabase`. That is because we need the passphrase, to decrypt the existing database or create the new database. Ideally, we want to hold onto the passphrase as little as possible, so miscreants cannot use kernel debuggers and the like to try to extract a copy of the passphrase from memory. Hence, we need to separately initialize the singleton with the passphrase.

We still have compile issues with the `buildSelectAllLoader()` method, as it is using a `SQLiteCursorLoader`, which will not work with `SQLCipher` for Android. Instead, there is a `SQLCipherCursorLoader` that will. So, replace the import for `SQLiteCursorLoader` with one for `com.commonware.cwac.loaderex.acl.SQLCipherCursorLoader` (note the `.acl` in the import, to pick up the one for use with the Android Support package backport of

## TUTORIAL: UPGRADING TO SQLCIPHER

---

the Loader framework). Then, replace the implementation of `buildSelectAllLoader()` with the following *static* method:

```
static SQLCipherCursorLoader buildSelectAllLoader(Context ctxt) {
    return(new SQLCipherCursorLoader(
        ctxt,
        getDatabase(),
        "SELECT _id, title, passphrase FROM roster
ORDER BY title",
        null));
}
```

We go ahead and make this method static, as we are not using any instance methods of `SQLiteOpenHelper` anymore — we get our database via the same `getDatabase()` accessor that anyone else can.

This, in turn, breaks `RosterFragment`, so we need to make a few changes to it.

First, change the data type of the loader data member of `RosterFragment` from `SQLiteCursorLoader` to `SQLCipherCursorLoader`, adjusting the import to `com.commonware.cwac.loaderex.acl.SQLCipherCursorLoader`. You will also need to adjust the cast in `onActivityCreated()` to refer to `SQLCipherCursorLoader`.

Then, change the `onCreateLoader()` method of `RosterFragment` to refer to the new static version of `buildSelectAllLoader()` on `DatabaseHelper`:

```
@Override
public Loader<Cursor> onCreateLoader(int loaderId, Bundle args) {
    loader=DatabaseHelper.buildSelectAllLoader(getActivity());

    return(loader);
}
```

At this point, we are no longer using our `db` data member in `RosterFragment`, so you can delete it and the line in `onActivityCreated()` that initializes it.

Now, all compile errors should be resolved, and your code should consistently use `SQLCipher` for Android. If you run this revised version of your app, and supply a passphrase to `AuthActivity`, clicking the OK button will encrypt your existing database and show your existing passwords. You can also clear the data from your app via the Settings app (or by uninstalling it), re-run your revised app, and confirm that it will create a new empty encrypted database.

All that remains is for us to handle the case where we already have an encrypted database, which we will address in the next step of the tutorial.

## Step #6: Collect Passphrase For Decryption

In truth, most of our logic for handling the existing encrypted database scenario is already in place. We just need to hide the confirm EditText widget, as we do not need it. Otherwise, our current code will open the encrypted database just fine.

To hide the confirm EditText widget, add the following lines to onCreate() in AuthActivity, somewhere late in the method, after you have initialized both the dbState and confirm data members:

```
if (dbState == State.ENCRYPTED) {
    confirm.setVisibility(View.GONE);
}
```

This simply hides the widget if we already have an encrypted database.

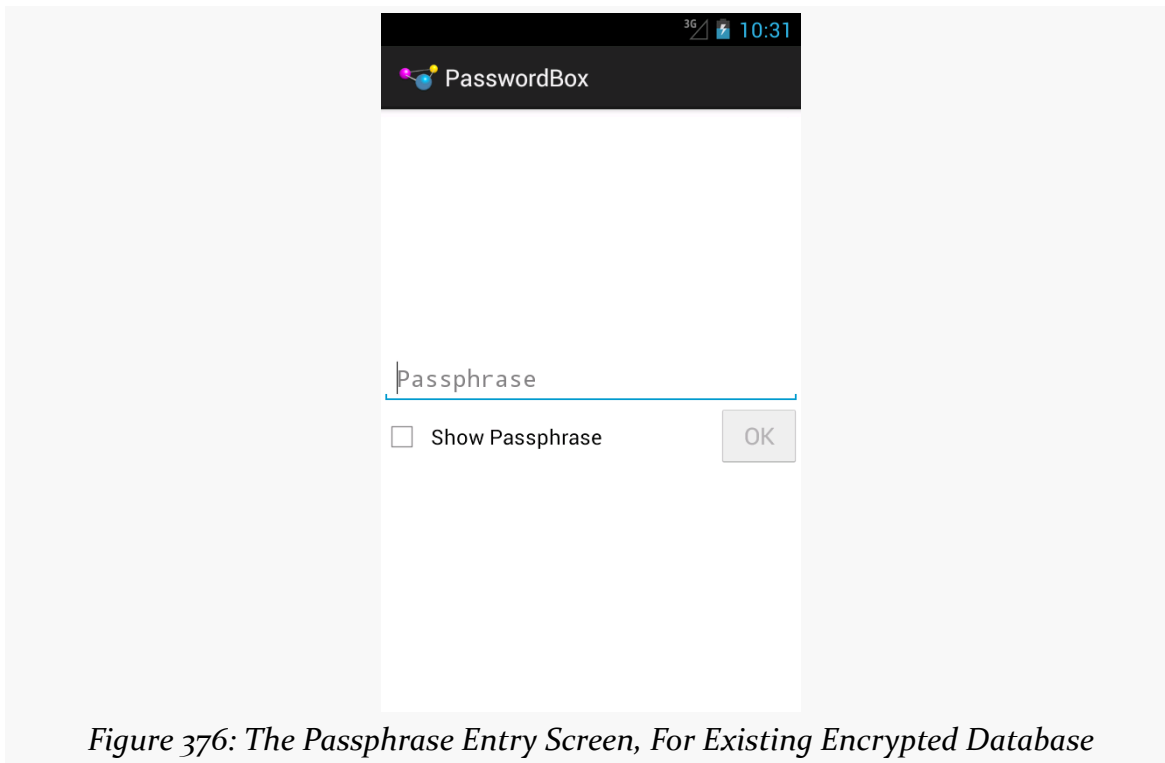
However, this means that our do-the-EditText-widgets-match logic in afterTextChanged() of AuthActivity needs adjustment, since we will never fill anything into the confirm widget if it is gone. Change afterTextChanged() to look like this:

```
@Override
public void afterTextChanged(Editable s) {
    boolean needsNoConfirm=confirm.getVisibility() == View.GONE;

    ok.setEnabled(dbState != State.UNKNOWN
        && passphrase.getText().length() > 0
        && (needsNoConfirm || passphrase.getText()
            .toString()
            .equals(confirm.getText()
                .toString())));
}
```

Here, we will only enable the OK button if the database state is known (which it should be by this time, but it never hurts to double-check). Also, we will enable the OK button if either both EditText widgets have the same contents or we do not need the confirmation.

If you run this revised version of the app, you will see the single-field edition of the layout when you have an encrypted database:



*Figure 376: The Passphrase Entry Screen, For Existing Encrypted Database*

Also, if you supply the passphrase to your existing encrypted database, you should see whatever passwords you stored in the box.



# Packaging and Distributing Data

---

Sometimes, you not only want to ship your code and simple resources with your app, but you also want to ship other types of data, such as an initial database that your app will use when first run. This chapter will examine the means by which you can do those sorts of things.

## Prerequisites

Understanding this chapter requires that you have read the chapters on:

- [database access](#)
- [content provider theory](#)
- [content provider implementations](#)

## Packing a Database To Go

Android's support for databases is focused on databases you create and populate entirely at runtime. Even if you want some initial data in the database, the expectation is that you would add that via Java code, such as the series of `insert()` calls we made in the `DatabaseHelper` of the various flavors of the `ConstantsBrowser` sample application.

However, that is tedious and slow for larger initial data sets, even if you make careful use of transactions to minimize the disk I/O.

What would be nice is to be able to ship a pre-populated database with your app. While Android does not offer built-in support for this, there are a few ways you can accomplish it yourself. One of the easiest, though, is to use existing third-party code

that supports this pattern, such as Jeff Gilfelt's `SQLiteAssetHelper`, available via [a GitHub repository](#).

`SQLiteAssetHelper` replaces your existing `SQLiteOpenHelper` subclass with one that handles database creation and upgrading for you. Rather than you writing a lot of SQL code for each of those, you provide a ZIP file with a pre-populated SQLite database (for creation) and a series of SQL scripts (for upgrades).

`SQLiteAssetHelper` then does the work to set up your pre-populated database when the database is first accessed and running your SQL scripts as needed to handle schema changes. And, `SQLiteAssetHelper` is open source, licensed under the same Apache License 2.0 that is used for Android proper.

To examine `SQLiteAssetHelper` in action, let's look at the [Database/ConstantsAssets](#) sample project. This is yet another rendition of the same app as the other flavors of `ConstantsBrowser`, but one where we use a pre-populated database.

### Create and Pack the Database

Whereas normally you create your SQLite database at runtime from Java code in your app, you now create your SQLite database using whatever tools you like, at development time. Whether you use the command-line `sqlite3` utility, the SQLite Manager extension for Firefox, or anything else, is up to you. You will need to set up all of your tables, indexes, and so forth.

You might think that you would store the SQLite database in your project's `assets/` directory, given the name of the `SQLiteAssetHelper` class. That is not quite how it works. Your raw database will need to go somewhere else that can be version-controlled but is not part of normal APK packaging (e.g., create a `misc/` directory in your project and put it there). Then, you need to:

1. Create an `assets/databases/` directory in your project
2. Use a ZIP utility (command-line `zip`, WinZip, native OS ZIP archive capability, etc.) to compress your database file and put it in `assets/databases/` under the proper name

The “proper name” for the ZIP file is your database's original name, with the `.zip` extension. So, for example, a `foo.db` raw SQLite database file would need to be ZIP-compressed and stored in `assets/databases/foo.db.zip`. Particularly if you are using Ant, you might consider adding commands to your build script to automatically do this compression (e.g., using Ant's `<zip>` task).

The reason for the ZIP compression comes from an Android limitation – assets that are compressed by the Android build tools have a file-size limitation (around 1MB). Hence, you need to store larger files in a file format that will not be compressed by the Android build tools, and those tools will not try to compress a .zip file.

In the ConstantsAssets project, you will see an assets/databases/constants.db.zip file, containing a copy of the SQLite database with our constants table and pre-populated values.

### Unpack the Database, With a Little Help(er)

Your compressed database will ship with your APK. To get it into its regular position on internal storage, you use SQLiteAssetHelper. Simply create a subclass of SQLiteAssetHelper and override its constructor, supplying the same values as you would for a SQLiteOpenHelper subclass, notably the database name and schema revision number. Note that the database name that you use must match the filename of the compressed database, minus the .zip extension.

So, for example, our new DatabaseHelper looks like this:

```
package com.commonware.android.dbasset;

import android.content.Context;
import com.readystatesoftware.sqliteasset.SQLiteAssetHelper;

class DatabaseHelper extends SQLiteAssetHelper {
    private static final String DATABASE_NAME="constants.db";

    public DatabaseHelper(Context context) {
        super(context, DATABASE_NAME, null, 1);
    }
}
```

SQLiteAssetHelper will then copy your database out of assets and set it up for conventional use, as soon as you call getReadableDatabase() or getWritableDatabase() on an instance of your SQLiteAssetHelper subclass.

### Upgrading Sans Java

Traditionally, with SQLiteOpenHelper, to handle a revision in your schema, you override onUpgrade() and do the upgrade work in there. With SQLiteAssetHelper, there is a built-in onUpgrade() method that uses SQL scripts in your APK to do the upgrade work instead.



## PACKAGING AND DISTRIBUTING DATA

---

These scripts will also reside in your `assets/databases/` directory of your project. The name of the file will be `$NAME_upgrade_$FROM-$TO.sql`, where you replace `$NAME` with the name of your database (e.g., `constants.db`), `$FROM` with the old schema version number (e.g., `1`) and `$TO` with the new schema version number (e.g., `2`). Hence, you wind up with files like `assets/databases/constants.db_upgrade_1-2.sql`. This should contain the SQL statements necessary to upgrade your schema between the versions.

`SQLiteAssetHelper` will chain these together as needed. Hence, to upgrade from schema version `1` to `3`, you could either have a single dedicated `1->3` script, or a `1->2` script and a `2->3` script.

### Limitations

The biggest limitation comes with disk space. Since APK files are read-only at runtime, you cannot delete the copy of the database held as an asset in your APK file once `SQLiteAssetHelper` has unpacked it. This means that the space taken up by your ZIP file will be taken up indefinitely. Note, though, that you could use this to your advantage, offering the user a “start over from scratch” option that deletes their existing database, so `SQLiteAssetHelper` will unpack a fresh original copy on the next run. Or, you could implement a `SQLiteDownloadHelper` that follows the `SQLiteAssetHelper` approach but obtains its database from the Internet instead of from assets.

In principle, SQLite could change their file format. If that ever happens, you will need to make sure that you create a SQLite database in the file format that can be used by Android, more so than what can be used by the latest SQLite standalone tools.

# Audio Playback

---

Whether it comes in the form of simple beeps or in the form of symphonies (or gangster rap or whatever), Android applications often need to play audio. A few things in Android can play audio automatically, such as [a Notification](#). However, once you get past those, you are own your own.

Fortunately for you, Android offers support for audio playback, and we will examine some of the options in this chapter.

## Prerequisites

Understanding this chapter requires that you have read the core chapters of this book.

## Get Your Media On

In Android, you have five different places you can pull media clips from — one of these will hopefully fit your needs:

- You can package audio clips as raw resources (`res/raw` in your project), so they are bundled with your application. The benefit is that you're guaranteed the clips will be there; the downside is that they cannot be replaced without upgrading the application.
- You can package audio clips as assets (`assets/` in your project) and reference them via `file:///android_asset/` URLs in a `Uri`. The benefit over raw resources is that this location works with APIs that expect `Uri` parameters instead of resource IDs. The downside — assets are only replaceable when the application is upgraded — remains.

- You can store media in an application-local directory, such as content you download off the Internet. Your media may or may not be there, and your storage space isn't infinite, but you can replace the media as needed.
- You can store media — or make use of media that the user has stored herself — that is on an SD card. There is likely more storage space on the card than there is on the device, and you can replace the media as needed, but other applications have access to the SD card as well.
- You can, in some cases, stream media off the Internet, bypassing any local storage

Remember that on Android 1.x/2.x devices, internal storage space is at a premium. That means you should only package small clips in your app (`assets/` or `res/raw/`) and download larger clips to external storage.

## MediaPlayer for Audio

If you want to play back music, particularly material in MP3 format, you will want to use the `MediaPlayer` class. With it, you can feed it an audio clip, start/stop/pause playback, and get notified on key events, such as when the clip is ready to be played or is done playing.

You have three ways to set up a `MediaPlayer` and tell it what audio clip to play:

- If the clip is a raw resource, use `MediaPlayer.create()` and provide the resource ID of the clip
- If you have a `Uri` to the clip, use the `Uri`-flavored version of `MediaPlayer.create()`
- If you have a string path to the clip, just create a `MediaPlayer` using the default constructor, then call `setDataSource()` with the path to the clip

Next, you need to call `prepare()` or `prepareAsync()`. Both will set up the clip to be ready to play, such as fetching the first few seconds off the file or stream. The `prepare()` method is synchronous; as soon as it returns, the clip is ready to play. The `prepareAsync()` method is asynchronous — more on how to use this version later.

Once the clip is prepared, `start()` begins playback, `pause()` pauses playback (with `start()` picking up playback where `pause()` paused), and `stop()` ends playback. One caveat: you cannot simply call `start()` again on the `MediaPlayer` once you have called `stop()` — we'll cover a workaround a bit later in this section.

## AUDIO PLAYBACK

---

To see this in action, take a look at the [Media/Audio](#) sample project. The layout is pretty trivial, with three buttons and labels for play, pause, and stop:

```
<?xml version="1.0" encoding="utf-8"?>
<LinearLayout xmlns:android="http://schemas.android.com/apk/res/android"
    android:orientation="vertical"
    android:layout_width="fill_parent"
    android:layout_height="fill_parent"
    >
    <LinearLayout
        android:orientation="horizontal"
        android:layout_width="fill_parent"
        android:layout_height="wrap_content"
        android:padding="4dip"
        >
        <ImageButton android:id="@+id/play"
            android:src="@drawable/play"
            android:layout_height="wrap_content"
            android:layout_width="wrap_content"
            android:paddingRight="4dip"
            android:enabled="false"
            />
        <TextView
            android:text="Play"
            android:layout_width="fill_parent"
            android:layout_height="fill_parent"
            android:gravity="center_vertical"
            android:layout_gravity="center_vertical"
            android:textAppearance="?android:attr/textAppearanceLarge"
            />
    </LinearLayout>
    <LinearLayout
        android:orientation="horizontal"
        android:layout_width="fill_parent"
        android:layout_height="wrap_content"
        android:padding="4dip"
        >
        <ImageButton android:id="@+id/pause"
            android:src="@drawable/pause"
            android:layout_height="wrap_content"
            android:layout_width="wrap_content"
            android:paddingRight="4dip"
            />
        <TextView
            android:text="Pause"
            android:layout_width="fill_parent"
            android:layout_height="fill_parent"
            android:gravity="center_vertical"
            android:layout_gravity="center_vertical"
            android:textAppearance="?android:attr/textAppearanceLarge"
            />
    </LinearLayout>
</LinearLayout>
```

## AUDIO PLAYBACK

---

```
    android:orientation="horizontal"
    android:layout_width="fill_parent"
    android:layout_height="wrap_content"
    android:padding="4dip"
  >
  <ImageButton android:id="@+id/stop"
    android:src="@drawable/stop"
    android:layout_height="wrap_content"
    android:layout_width="wrap_content"
    android:paddingRight="4dip"
  />
  <TextView
    android:text="Stop"
    android:layout_width="fill_parent"
    android:layout_height="fill_parent"
    android:gravity="center_vertical"
    android:layout_gravity="center_vertical"
    android:textAppearance="?android:attr/textAppearanceLarge"
  />
</LinearLayout>
</LinearLayout>
```

The Java, of course, is where things get interesting:

```
package com.commonsware.android.audio;

import android.app.Activity;
import android.app.AlertDialog;
import android.content.Context;
import android.content.SharedPreferences;
import android.media.MediaPlayer;
import android.os.Bundle;
import android.view.Menu;
import android.view.MenuItem;
import android.view.View;
import android.widget.ImageButton;
import android.widget.Toast;

public class AudioDemo extends Activity
    implements MediaPlayer.OnCompletionListener {

    private ImageButton play;
    private ImageButton pause;
    private ImageButton stop;
    private MediaPlayer mp;

    @Override
    public void onCreate(Bundle icle) {
        super.onCreate(icle);
        setContentView(R.layout.main);

        play=(ImageButton)findViewById(R.id.play);
        pause=(ImageButton)findViewById(R.id.pause);
```

## AUDIO PLAYBACK

---

```
stop=(ImageButton)findViewById(R.id.stop);

play.setOnClickListener(new View.OnClickListener() {
    public void onClick(View view) {
        play();
    }
});

pause.setOnClickListener(new View.OnClickListener() {
    public void onClick(View view) {
        pause();
    }
});

stop.setOnClickListener(new View.OnClickListener() {
    public void onClick(View view) {
        stop();
    }
});

setup();
}

@Override
public void onDestroy() {
    super.onDestroy();

    if (stop.isEnabled()) {
        stop();
    }
}

public void onCompletion(MediaPlayer mp) {
    stop();
}

private void play() {
    mp.start();

    play.setEnabled(false);
    pause.setEnabled(true);
    stop.setEnabled(true);
}

private void stop() {
    mp.stop();
    pause.setEnabled(false);
    stop.setEnabled(false);

    try {
        mp.prepare();
        mp.seekTo(0);
        play.setEnabled(true);
    }
}
```

## AUDIO PLAYBACK

---

```
        catch (Throwable t) {
            goBlooley(t);
        }
    }

    private void pause() {
        mp.pause();

        play.setEnabled(true);
        pause.setEnabled(false);
        stop.setEnabled(true);
    }

    private void loadClip() {
        try {
            mp=MediaPlayer.create(this, R.raw.clip);
            mp.setOnCompletionListener(this);
        }
        catch (Throwable t) {
            goBlooley(t);
        }
    }

    private void setup() {
        loadClip();
        play.setEnabled(true);
        pause.setEnabled(false);
        stop.setEnabled(false);
    }

    private void goBlooley(Throwable t) {
        AlertDialog.Builder builder=new AlertDialog.Builder(this);

        builder
            .setTitle("Exception!")
            .setMessage(t.toString())
            .setPositiveButton("OK", null)
            .show();
    }
}
```

In `onCreate()`, we wire up the three buttons to appropriate callbacks, then call `setup()`. In `setup()`, we create our `MediaPlayer`, set to play a clip we package in the project as a raw resource. We also configure the activity itself as the completion listener, so we find out when the clip is over. Note that, since we use the static `create()` method on `MediaPlayer`, we have already implicitly called `prepare()`, so we do not need to call that separately ourselves.

The buttons simply work the `MediaPlayer` and toggle each others' states, via appropriately-named callbacks. So, `play()` starts `MediaPlayer` playback, `pause()` pauses playback, and `stop()` stops playback and resets our `MediaPlayer` to play

## AUDIO PLAYBACK

---

again. The `stop()` callback is also used for when the audio clip completes of its own accord.

To reset the `MediaPlayer`, the `stop()` callback calls `prepare()` on the existing `MediaPlayer` to enable it to be played again and `seekTo()` to move the playback point to the beginning. If we were using an external file as our media source, it would be better to call `prepareAsync()`.

The UI is nothing special, but we are more interested in the audio in this sample, anyway:



*Figure 377: The AudioDemo sample application*

### Streaming Limitations

You can use the same basic code for streaming media, using an `http://` or `rtsp://` URL. However, bear in mind that Android does not support streaming MP3 over RTSP, as that exceeds the relevant RTSP specifications. That being said, there *are* MP3-over-RTSP streams in the world, and clients and servers that have negotiated an ad-hoc extension to the specification to accommodate this. Android cannot play these streams.



## Other Ways to Make Noise

While MediaPlayer is the primary audio playback option, particularly for content along the lines of MP3 files, there are other alternatives if you are looking to build other sorts of applications, notably games and custom forms of streaming audio.

### SoundPool

The SoundPool class's claim to fame is the ability to overlay multiple sounds, and do so in a prioritized fashion, so your application can just ask for sounds to be played and SoundPool deals with each sound starting, stopping, and blending while playing.

This may make more sense with an example.

Suppose you are creating a first-person shooter. Such a game may have several sounds going on at any one time:

1. The sound of the wind whistling amongst the trees on the battlefield
2. The sound of the surf crashing against the beach in the landing zone
3. The sound of booted feet crunching on the sand
4. The sound of the character's own panting as the character runs on the beach
5. The sound of orders being barked by a sergeant positioned behind the character
6. The sound of machine gun fire aimed at the character and the character's squad mates
7. The sound of explosions from the gun batteries of the battleship providing suppression fire

And so on.

In principle, SoundPool can blend all of those together into a single audio stream for output. Your game might set up the wind and surf as constant background sounds, toggle the feet and panting on and off based on the character's movement, randomly add the barked orders, and tie the gunfire based on actual game play.

In reality, your average smartphone will lack the CPU power to handle all of that audio without harming the frame rate of the game. So, to keep the frame rate up, you tell SoundPool to play at most two streams at once. This means that when nothing else is happening in the game, you will hear the wind and surf, but during

the actual battle, those sounds get dropped out — the user might never even miss them — so the game speed remains good.

### AudioTrack

The lowest-level Java API for playing back audio is `AudioTrack`. It has two main roles:

1. Its primary role is to support streaming audio, where the streams come in some format other than what `MediaPlayer` handles. While `MediaPlayer` can handle RTSP, for example, it does not offer SIP. If you want to create a SIP client (perhaps for a VOIP or Web conferencing application), you will need to convert the incoming data stream to PCM format, then hand the stream off to an `AudioTrack` instance for playback.
2. It can also be used for “static” (versus streamed) bits of sound that you have pre-decoded to PCM format and want to play back with as little latency as possible. For example, you might use this for a game for in-game sounds (beeps, bullets, or “boing”s). By pre-decoding the data to PCM and caching that result, then using `AudioTrack` for playback, you will use the least amount of overhead, minimizing CPU impact on game play and on battery life.

### ToneGenerator

If you want your phone to sound like... well... a phone, you can use `ToneGenerator` to have it play back [dual-tone multi-frequency](#) (DTMF) tones. In other words, you can simulate the sounds played by a regular “touch-tone” phone in response to button presses. This is used by the Android dialer, for example, to play back the tones when users dial the phone using the on-screen keypad, as an audio reinforcement.

Note that these will play through the phone’s earpiece, speaker, or attached headset. They do not play through the outbound call stream. In principle, you might be able to get `ToneGenerator` to play tones through the speaker loud enough to be picked up by the microphone, but this probably is not a recommended practice.



# Audio Recording

---

Most Android devices have microphones. On such devices, it might be nice to get audio input from those microphones, whether to record locally, process locally (e.g., speech recognition), or to stream out over the Internet (e.g., voice over IP).

Not surprisingly, Android has some capabilities in this area. Also, not surprisingly, there are multiple APIs, with varying mixes of power and complexity, to allow you capture microphone input. In this chapter, we will examine `MediaRecorder` for recording audio files and `AudioRecord` for raw microphone input.

## Prerequisites

Understanding this chapter requires that you have read the core chapters of this book. Having read the chapter on [audio playback](#) is probably also a good idea. And, for the section on playing back local streams, you will want to have read up on content providers, particularly [the chapter on provider patterns](#).

## Recording by Intent

Just as the easiest way to take a picture with the camera is [to use the device's built-in camera app](#), the easiest way to record some audio is to use a built-in activity for it. And, as with using the built-in camera app, the built-in audio recording activity has some significant limitations.

Requesting the built-in audio recording activity is a matter of calling `startActivityForResult()` for a `MediaStore.Audio.Media.RECORD_SOUND_ACTION` action. You can see this in the [Media/SoundRecordIntent](#) sample project, specifically the `MainActivity`:

## AUDIO RECORDING

---

```
package com.commonware.android.soundrecord;

import android.app.Activity;
import android.content.Intent;
import android.os.Bundle;
import android.provider.MediaStore;
import android.widget.Toast;

public class MainActivity extends Activity {
    private static final int REQUEST_ID=1337;

    @Override
    public void onCreate(Bundle savedInstanceState) {
        super.onCreate(savedInstanceState);

        Intent i=new Intent(MediaStore.Audio.Media.RECORD_SOUND_ACTION);

        startActivityForResult(i, REQUEST_ID);
    }

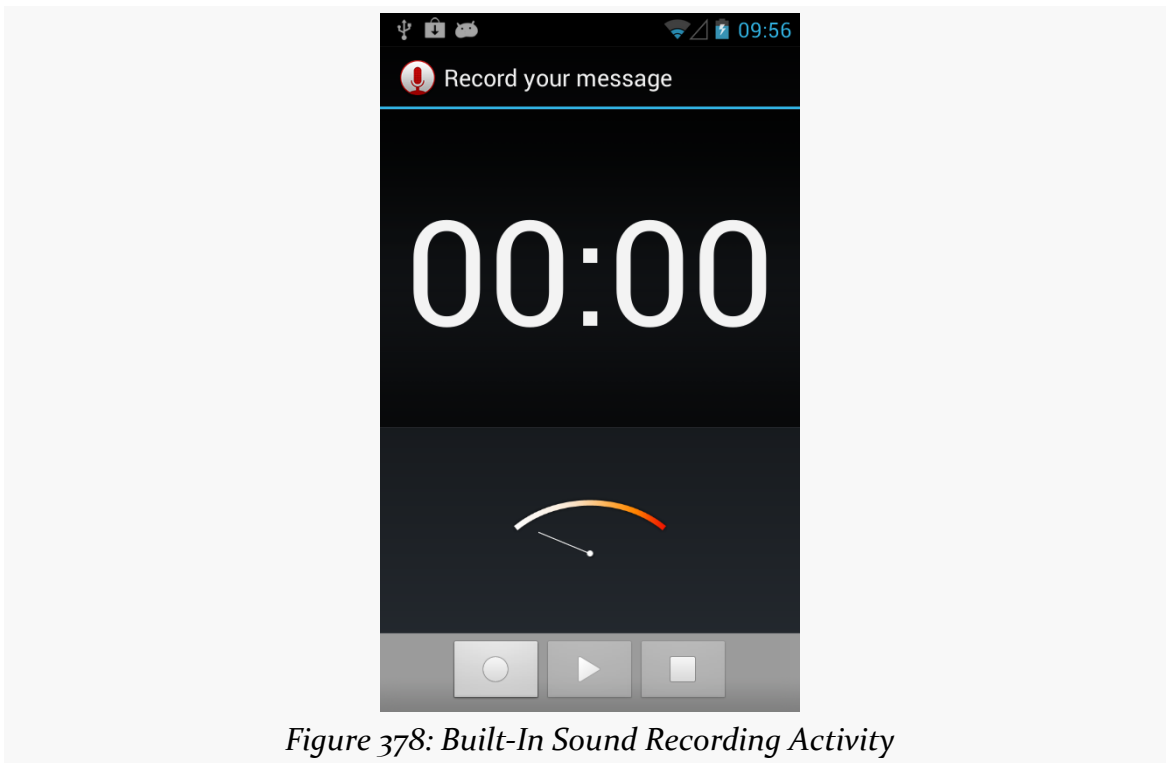
    @Override
    protected void onActivityResult(int requestCode, int resultCode,
        Intent data) {
        if (requestCode == REQUEST_ID && resultCode == RESULT_OK) {
            Toast.makeText(this, "Recording finished!", Toast.LENGTH_LONG)
                .show();
        }

        finish();
    }
}
```

As with a few other sample apps in this book, the `Media/SoundRecordIntent` uses a `Theme.NoDisplay` activity, eschewing its own UI. Instead, in `onCreate()`, we immediately call `startActivityForResult()` for `MediaStore.Audio.Media.RECORD_SOUND_ACTION`. That will bring up a recording activity:

## AUDIO RECORDING

---



*Figure 378: Built-In Sound Recording Activity*

If the user records some audio via the “record” `ImageButton` (one with the circle icon) and the “stop” `ImageButton` (one with the square icon), you will get control back in `onActivityResult()`, where you are passed an `Intent` whose `Uri` (via `getData()`) will point to this audio recording in the `MediaStore`.

However:

- You have no control over where the file is stored or what it is named. It appears that, by default, these files are dumped unceremoniously in the root of external storage.
- You have no control over anything about the way the audio is recorded, such as codecs or bitrates. For example, it appears that, by default, the files are recorded in AMR format.
- `ACTION_VIEW` may not be able to play back this audio (leastways, it failed to in testing on a few devices). Whether that is due to codecs, the way the data is put in `MediaStore`, or the limits of the default audio player on Android, is unclear.

Hence, in many cases, while this works, it may not work well enough — or controlled enough — to meet your needs. In that case, you will want to handle the recording yourself, as will be described in the next couple of sections.

## Recording to Files

If your objective is to record a voice note, a presentation, or something along those lines, then `MediaRecorder` is probably the class that you want. It will let you specify what sort of media you wish to record, in what format, and to what location. It then handles the actual act of recording.

To illustrate this, let us review the [Media/AudioRecording](#) sample project.

Our activity's layout consists of a single `ToggleButton` widget named `record`:

```
<ToggleButton xmlns:android="http://schemas.android.com/apk/res/android"
  xmlns:tools="http://schemas.android.com/tools"
  android:id="@+id/record"
  android:layout_width="fill_parent"
  android:layout_height="fill_parent"
  android:textAppearance="?android:attr/textAppearanceLarge"/>
```

In `onCreate()` of `MainActivity`, we load the layout and set the activity itself up as the `OnCheckedChangeListener`, to find out when the user toggles the button:

```
@Override
public void onCreate(Bundle savedInstanceState) {
    super.onCreate(savedInstanceState);
    setContentView(R.layout.activity_main);

    ((ToggleButton)findViewById(R.id.record)).setOnCheckedChangeListener(this);
}
```

Also, in `onResume()`, we initialize a `MediaRecorder`, setting the activity up as being the one to handle info and error events about the recording. Similarly, we `release()` the `MediaRecorder` in `onPause()`, to reduce our overhead when we are not in the foreground:

```
@Override
public void onResume() {
    super.onResume();

    recorder=new MediaRecorder();
    recorder.setOnErrorListener(this);
    recorder.setOnInfoListener(this);
}
```

## AUDIO RECORDING

---

```
@Override
public void onPause() {
    recorder.release();
    recorder=null;

    super.onPause();
}
```

Most of the work occurs in `onCheckedChanged()`, where we get control when the user toggles the button. If we are now checked, we begin recording; if not, we stop the previous recording:

```
@Override
public void onCheckedChanged(CompoundButton buttonView,
                             boolean isChecked) {
    if (isChecked) {
        File output=
            new File(
Environment.getExternalStoragePublicDirectory(Environment.DIRECTORY_DOWNLOADS),
                BASENAME);

        recorder.setAudioSource(MediaRecorder.AudioSource.MIC);
        recorder.setOutputFormat(MediaRecorder.OutputFormat.THREE_GPP);
        recorder.setOutputFile(output.getAbsolutePath());

        if (Build.VERSION.SDK_INT >= Build.VERSION_CODES.GINGERBREAD_MR1) {
            recorder.setAudioEncoder(MediaRecorder.AudioEncoder.AAC);
            recorder.setAudioEncodingBitRate(160 * 1024);
        }
        else {
            recorder.setAudioEncoder(MediaRecorder.AudioEncoder.AMR_NB);
        }

        recorder.setAudioChannels(2);

        try {
            recorder.prepare();
            recorder.start();
        }
        catch (Exception e) {
            Log.e(getClass().getSimpleName(),
                "Exception in preparing recorder", e);
            Toast.makeText(this, e.getMessage(), Toast.LENGTH_LONG).show();
        }
    }
    else {
        try {
            recorder.stop();
        }
        catch (Exception e) {
            Log.w(getClass().getSimpleName(),
```



## AUDIO RECORDING

---

```
        "Exception in stopping recorder", e);
        // can fail if start() failed for some reason
    }

    recorder.reset();
}
}
```

To record audio, we:

- Create a File object representing where the recording should be stored, in this case using `Environment.getExternalStoragePublicDirectory()` to find a location on external storage
- Tell the `MediaRecorder` that we wish to record from the microphone, through a call to `setAudioSource()`, that we wish to record a 3GP file via a call to `setOutputFormat()`, and that we wish to record the results to our File via a call to `setOutputFile()`
- If we are running on Android 2.3.3 or higher, we can also configure our encoder to be AAC via `setAudioEncoder()` and set our requested bitrate to 160Kbps via `setAudioEncodingBitRate()` — otherwise, we use `setAudioEncoder()` to request AMR narrowband
- Indicate how many audio channels we want via `setAudioChannels()`, such as 2 to attempt to record in stereo
- Kick off the actual recording via calls to `prepare()` (to set up the output file) and `record()`

Stopping the recording, when the user toggles off the button, is merely a matter of calling `stop()` on the `MediaRecorder`.

Because we told the `MediaRecorder` that our activity was our `OnErrorListener` and `OnInfoListener`, we have to implement those interfaces on the activity and implement their required methods (`onError()` and `onInfo()`, respectively). In the normal course of events, neither of these should be triggered. If they are, we are passed an int value (typically named `what`) that indicates what happened:

```
@Override
public void onInfo(MediaRecorder mr, int what, int extra) {
    String msg=getString(R.string.strange);

    switch (what) {
        case MediaRecorder.MEDIA_RECORDER_INFO_MAX_DURATION_REACHED:
            msg=getString(R.string.max_duration);
            break;

        case MediaRecorder.MEDIA_RECORDER_INFO_MAX_FILESIZE_REACHED:
```

```
        msg=getString(R.string.max_size);
        break;
    }

    Toast.makeText(this, msg, Toast.LENGTH_LONG).show();
}

@Override
public void onError(MediaRecorder mr, int what, int extra) {
    Toast.makeText(this, R.string.strange, Toast.LENGTH_LONG).show();
}
```

Here, we just raise a Toast in either case, with either a generic message or a specific message for the cases where the maximum time duration or the maximum file size for our recording has been reached.

We also need to hold the RECORD\_AUDIO and WRITE\_EXTERNAL\_STORAGE permissions. RECORD\_AUDIO, in particular, is needed to let the user know that we intend to record information off of the microphone.

The results are that we get a recording on external storage (typically in a Downloads directory) after we toggle the button on, record some audio, then toggle the button off.

MediaRecorder is rather fussy about the order of method calls for its configuration. For example, you must call setAudioEncoder() *after* the call to setOutputFormat().

Also, the available codecs and file types are rather limited. Notably, Android lacks the ability to record to MP3 format, perhaps due to patent licensing issues.

On the flip side, MediaRecorder also supports recording video, a topic which is not presently covered in this book.

## Recording to Streams

The nice thing about recording to files is that Android handles all of the actual file I/O for us. The downside is that because Android handles all of the actual file I/O for us, it can only write files that are accessible to it and our process, meaning external storage. This may not be suitable in all cases, such as wanting to record to some form of private encrypted storage.

The good news is that Android does support recording to streams, in the form of a pipe created by ParcelFileDescriptor and createPipe(). This follows the same

basic pattern that we saw in [the chapter on content provider patterns](#), where we [served a stream via a pipe](#). However, as you will see, there are some limits on how well we can do this.

To demonstrate and explain, let us examine the [Media/AudioRecordStream](#) sample project. This is nearly a complete clone of the previous sample, so we will only focus on the changes in this section.

The author would like to thank Lucio Maciel for his assistance in [getting this example to work](#).

### Setting Up the Stream

The biggest change, by far, is in our `setOutputFile()` call. Before, we supplied a path to external storage. Now, we supply the write end of a pipe:

```
recorder.setOutputFile(getStreamFd());
```

Our `getStreamFd()` method looks a lot like the `openFile()` method of our pipe-providing provider:

```
private FileDescriptor getStreamFd() {
    ParcelFileDescriptor[] pipe=null;

    try {
        pipe=ParcelFileDescriptor.createPipe();

        new TransferThread(new AutoCloseInputStream(pipe[0]),
            new FileOutputStream(getOutputFile())).start();
    }
    catch (IOException e) {
        Log.e(getClass().getSimpleName(), "Exception opening pipe", e);
    }

    return(pipe[1].getFileDescriptor());
}
```

We create our pipe with `createPipe()`, spawn a `TransferThread` to copy the recording from an `InputStream` to a `FileOutputStream`, and return the write end of the pipe. However, `setOutputFile()` on `MediaRecorder` takes the actual integer file descriptor, not a `ParcelFileDescriptor`, so we use `getFileDescriptor()` to retrieve the file descriptor and return that.

Our TransferThread is similar to the one from the content provider sample, except that we pass over a FileOutputStream, so we can not only flush() but also sync() when we are done writing:

```
static class TransferThread extends Thread {
    InputStream in;
    FileOutputStream out;

    TransferThread(InputStream in, FileOutputStream out) {
        this.in=in;
        this.out=out;
    }

    @Override
    public void run() {
        byte[] buf=new byte[8192];
        int len;

        try {
            while ((len=in.read(buf)) > 0) {
                out.write(buf, 0, len);
            }

            in.close();

            out.flush();
            out.getFD().sync();
            out.close();
        }
        catch (IOException e) {
            Log.e(getClass().getSimpleName(),
                "Exception transferring file", e);
        }
    }
}
```

### Changes in Recording Configuration

The biggest limitation of a pipe's stream is that it is *purely* a stream. You cannot rewind re-read earlier bits of data. In other words, the stream is not seekable.

That is a problem with MediaRecorder in some configurations. For example, a 3GP file contains a header with information about the overall file, information that MediaRecorder does not know until the recording is complete. In the case of a file, MediaRecorder can simply rewind and update the header with the final data when everything is done. However, that is not possible with a pipe-based stream.

However, some configurations will work, notably “raw” ones that just have the recorded audio, with no type of header. That is what we use in this sample.

Specifically, we now write to a .amr file:

```
private static final String BASENAME="recording-stream.amr";
```

We also set our output format to RAW\_AMR, and our encoder to AMR\_NB:

```
recorder.setAudioSource(MediaRecorder.AudioSource.MIC);
recorder.setOutputFormat(MediaRecorder.OutputFormat.RAW_AMR);
recorder.setOutputFile(getStreamFd());
recorder.setAudioEncoder(MediaRecorder.AudioEncoder.AMR_NB);
recorder.setAudioChannels(2);
```

This combination works. Other combinations might also work. But our approach of writing the 3GP file, as in the file-based example, will not work.

## Raw Audio Input

Just as `AudioTrack` allows you to play audio supplied as raw 8- or 16-bit PCM input, `AudioRecord` allows you to record audio from the microphone, supplied to you in PCM format. It is then up to you to actually do something with the raw byte PCM data, including converting it to some other format and container as needed.

Note that you need `RECORD_AUDIO` to work with `AudioRecord`, just as you need it to work with `MediaRecorder`.

## Requesting the Microphone

As noted in the opening paragraph of this chapter, most Android devices have microphones. The key word there is *most*. Not all Android devices will have microphones, as only some tablets (and fewer Google TV devices) will support microphone input.

As with most of this optional hardware, the solution is to use `<uses-feature>`. In that case, you would request the `android.hardware.microphone` feature, with `android:required="false"` if you felt that you do not absolutely *need* a microphone. In that case, you would use `hasSystemFeature()` on `PackageManager` to determine at runtime if you do indeed have a microphone.

## AUDIO RECORDING

---

Note that the `RECORD_AUDIO` permission implies that you need a microphone. Hence, even if you skip the `<uses-feature>` element, your app will still only ship to devices that have a microphone. If the microphone is optional, be sure to include `android:required="false"`, so your app will be available to devices that lack a microphone.



# Video Playback

---

Just as Android supports audio playback, it also supports video playback of local and streaming content. Unlike audio playback – which supports a mix of high-level and low-level APIs – video playback offers a purely high-level interface, in the form of the same `MediaPlayer` class you used for audio playback. To keep things a bit simpler, though, Android does offer a `VideoView` widget you can drop in an activity or fragment to play back video.

## Prerequisites

Understanding this chapter requires that you have read the core chapters of this book, along with [the chapter on audio playback](#).

## Moving Pictures

Video clips get their own widget, the `VideoView`. Put it in a layout, feed it an MP4 video clip, and you get playback!

For example, take a look at this layout, from the [Media/Video](#) sample project:

```
<?xml version="1.0" encoding="utf-8"?>
<LinearLayout xmlns:android="http://schemas.android.com/apk/res/android"
    android:orientation="vertical"
    android:layout_width="match_parent"
    android:layout_height="match_parent"
    >
    <VideoView
        android:id="@+id/video"
        android:layout_width="match_parent"
        android:layout_height="match_parent"
    >
```



## VIDEO PLAYBACK

---

```
    />  
</LinearLayout>
```

The layout is simply a full-screen video player. Whether it will use the full screen will be dependent on the video clip, its aspect ratio, and whether you have the device (or emulator) in portrait or landscape mode.

Wiring up the Java is almost as simple:

```
package com.commonsware.android.video;  
  
import java.io.File;  
import android.app.Activity;  
import android.graphics.PixelFormat;  
import android.os.Bundle;  
import android.os.Environment;  
import android.widget.MediaController;  
import android.widget.VideoView;  
  
public class VideoDemo extends Activity {  
    private VideoView video;  
    private MediaController ctrlr;  
  
    @Override  
    public void onCreate(Bundle icle) {  
        super.onCreate(icle);  
        getWindow().setFormat(PixelFormat.TRANSLUCENT);  
        setContentView(R.layout.main);  
  
        File clip=new File(Environment.getExternalStorageDirectory(),  
                            "test.mp4");  
  
        if (clip.exists()) {  
            video=(VideoView)findViewById(R.id.video);  
            video.setVideoPath(clip.getAbsolutePath());  
  
            ctrlr=new MediaController(this);  
            ctrlr.setMediaPlayer(video);  
            video.setMediaController(ctrlr);  
            video.requestFocus();  
            video.start();  
        }  
    }  
}
```

Here, we:

1. Confirm that our video file exists on external storage
2. Tell the VideoView which file to play

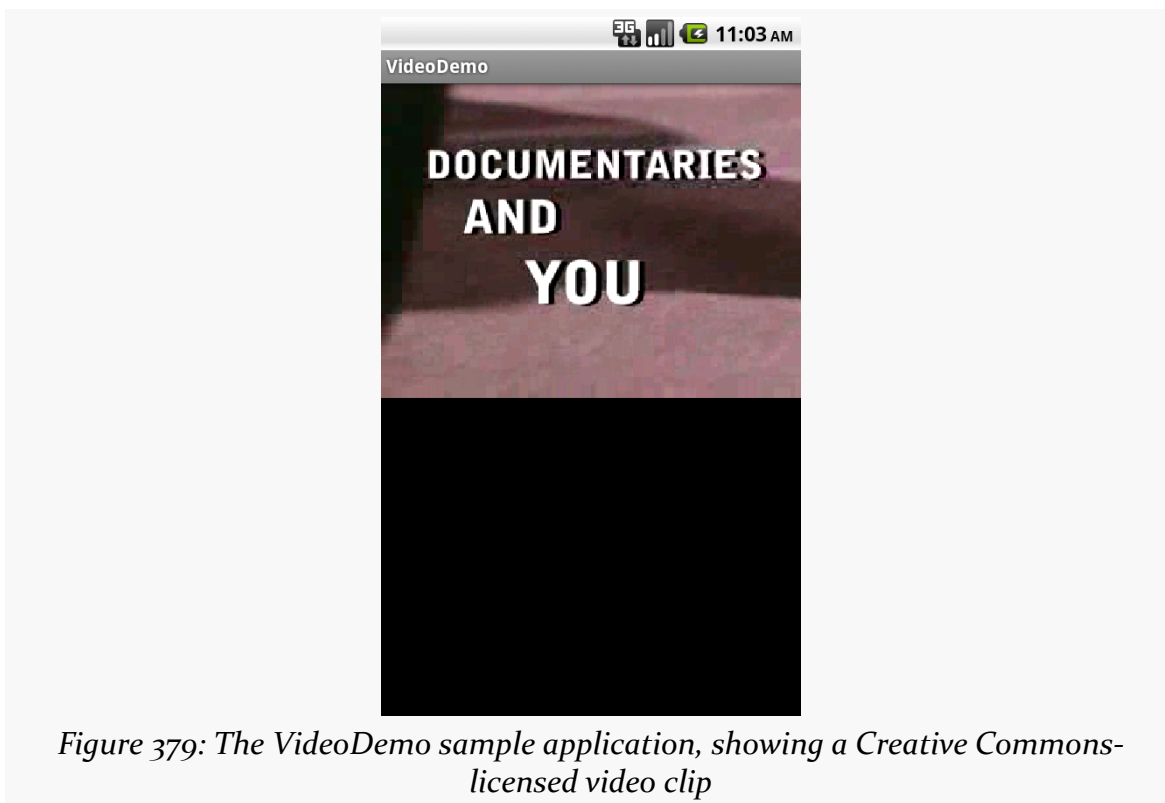
## VIDEO PLAYBACK

---

3. Create a `MediaController` pop-up panel and cross-connect it to the `VideoView`
4. Give the `VideoView` the focus and start playback

The biggest trick with `VideoView` is getting a video clip onto the device. While `VideoView` does support some streaming video, the requirements on the MP4 file are fairly stringent. If you want to be able to play a wider array of video clips, you need to have them on the device, preferably on an SD card.

The crude `VideoDemo` class assumes there is an MP4 file named `test.mp4` in the root of external storage on your device or emulator. Once there, the Java code shown above will give you a working video player:

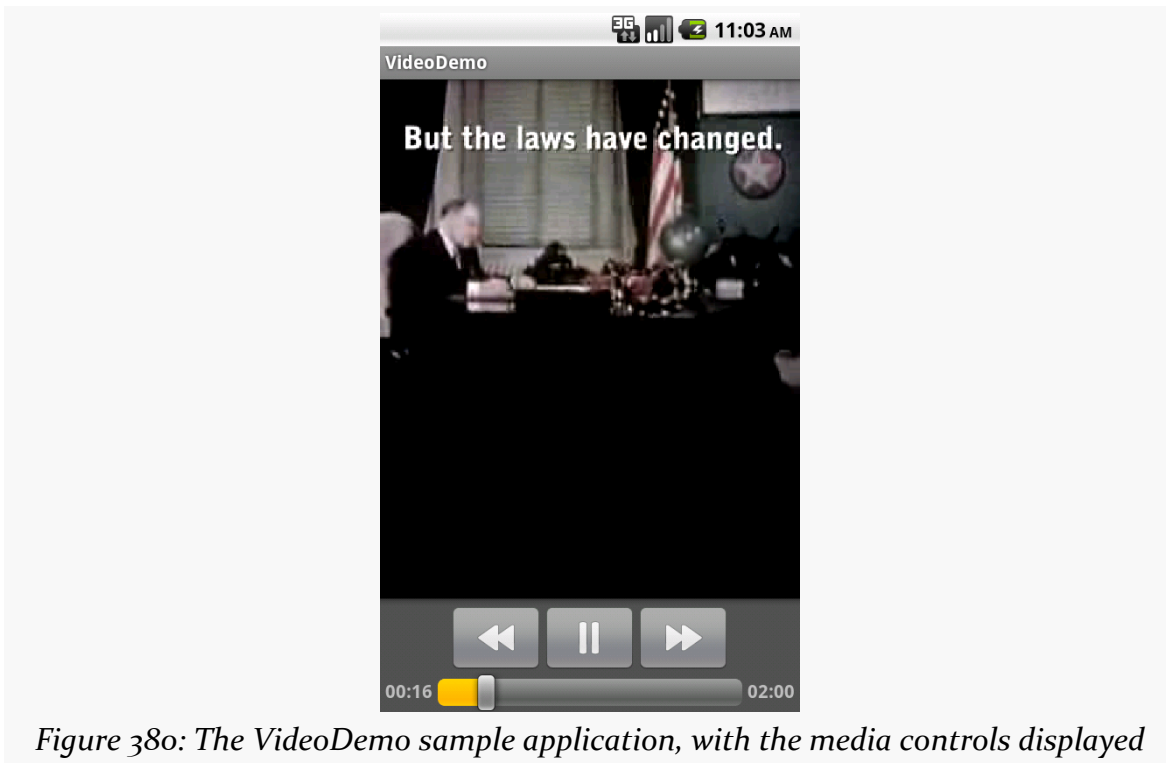


*Figure 379: The VideoDemo sample application, showing a Creative Commons-licensed video clip*

Tapping on the video will pop up the playback controls:

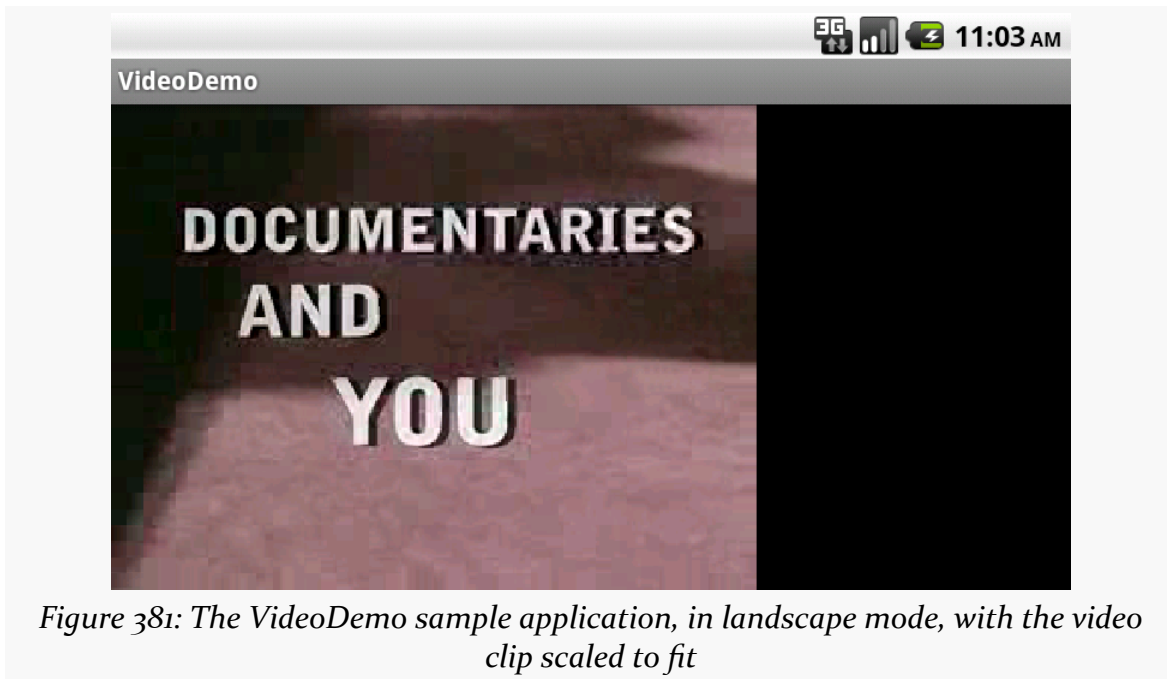
## VIDEO PLAYBACK

---



*Figure 380: The VideoDemo sample application, with the media controls displayed*

The video will scale based on space, as shown in this rotated view of the emulator (<Ctrl>-<F12>):



*Figure 381: The VideoDemo sample application, in landscape mode, with the video clip scaled to fit*

**NOTE:** playing video on the Android emulator may work for you, but it is not terribly likely. Video playback requires graphic acceleration to work well, and the emulator does not have graphics acceleration — regardless of the capabilities of the actual machine the emulator runs on. Hence, if you try playing back video in the emulator, expect problems. If you are serious about doing Android development with video playback, you definitely need to acquire a piece of Android hardware.



# Advanced Permissions

---

Adding basic permissions to your app to allow it to, say, access the Internet, is fairly easy. However, the full permissions system has many capabilities beyond simply asking the user to let you do something. This chapter explores other uses of permissions, from securing your own components to using signature-level permissions (your own or Android's).

## Prerequisites

Understanding this chapter requires that you have read the core chapters, particularly [the chapter on permissions](#) and the chapter on [signing your app](#). The discussion of signature-level permissions will make a bit more sense if you read through [the chapter on plugins](#) as well.

## Securing Yourself

Principally, at least initially, permissions are there to allow the user to secure their device. They have to agree to allow you to do certain things, such as reading contacts, that they might not appreciate.

The other side of the coin, of course, is to secure your own application. If your application is mostly activities, security may be just an “outbound” thing, where you request the right to use resources of other applications. If, on the other hand, you put content providers or services in your application, you will want to implement “inbound” security to control which applications can do what with the data.

Note that the issue here is less about whether other applications might “mess up” your data, but rather about privacy of the user's information or use of services that

## ADVANCED PERMISSIONS

---

might incur expense. That is where the stock permissions for built-in Android applications are focused – can you read or modify contacts, can you send SMS, etc. If your application does not store information that might be considered private, security is less an issue. If, on the other hand, your application stores private data, such as medical information, security is much more important.

The first step to securing your own application using permissions is to declare said permissions, once again in the `AndroidManifest.xml` file. In this case, instead of `uses-permission`, you add `permission` elements. Once again, you can have zero or more `permission` elements, all as direct children of the root `manifest` element.

Declaring a permission is slightly more complicated than using a permission. There are three pieces of information you need to supply:

- The symbolic name of the permission. To keep your permissions from colliding with those from other applications, you should use your application's Java namespace as a prefix
- A label for the permission: something short that would be understandable by users
- A description for the permission: something a wee bit longer that is understandable by your users

```
<permission
  android:name="vnd.tlagency.sekritis.SEE_SEKRITS"
  android:label="@string/see_sekritis_label"
  android:description="@string/see_sekritis_description" />
```

This does not enforce the permission. Rather, it indicates that it is a possible permission; your application must still flag security violations as they occur.

### Enforcing Permissions via the Manifest

There are two ways for your application to enforce permissions, dictating where and under what circumstances they are required. The easier one is to indicate in the manifest where permissions are required.

Activities, services, and receivers can all declare an attribute named `android:permission`, whose value is the name of the permission that is required to access those items:

```
<activity
  android:name=".SekritApp"
  android:label="Top Sekret"
```

```
android:permission="vnd.tlagency.sekritis.SEE_SEKRITS">
<intent-filter>
  <action android:name="android.intent.action.MAIN" />
  <category
    android:name="android.intent.category.LAUNCHER"
  />
</intent-filter>
</activity>
```

Only applications that have requested your indicated permission will be able to access the secured component. In this case, “access” means:

1. Activities cannot be started without the permission
2. Services cannot be started, stopped, or bound to an activity without the permission
3. Intent receivers ignore messages sent via `sendBroadcast()` unless the sender has the permission

### Enforcing Permissions Elsewhere

In your code, you have two additional ways to enforce permissions.

Your services can check permissions on a per-call basis via `checkCallingPermission()`. This returns `PERMISSION_GRANTED` or `PERMISSION_DENIED` depending on whether the caller has the permission you specified. For example, if your service implements separate read and write methods, you could require separate read versus write permissions in code by checking those methods for the permissions you need from Java.

Also, you can include a permission when you call `sendBroadcast()`. This means that eligible broadcast receivers must hold that permission; those without the permission are ineligible to receive it. We will examine `sendBroadcast()` in greater detail elsewhere in this book.

### Requiring Standard System Permissions

While normally you require your own custom permissions using the techniques described above, there is nothing stopping you from reusing a standard system permission, if it would fit your needs.

For example, suppose that you are writing YATC (Yet Another Twitter Client). You decide that in addition to YATC having its own UI, you will design YATC to be a “Twitter engine” for use by third party apps:



- Send timeline updates via broadcast Intents
- Publish the timeline, the user's own tweets, @-mentions, and the like via a ContentProvider
- Offer a command-based service interface for posting updates to the timeline
- And so on

You could, and perhaps should, implement your own custom permission. However, since any app can get to Twitter just by having the INTERNET permission, one could argue that a third-party app should just need that same INTERNET permission to use your API (rather than integrating JTwitter or another third-party JAR).

## Signature Permissions

Each permission in Android is assigned a protection level, via an `android:protectionLevel` attribute on the `<permission>` element. By default, permissions are at a normal level, but they can also be flagged as dangerous, `signatureOrSystem`, or `signature`. In the latter two cases, “signature” means that the app requesting the permission and the app requiring the permission should have been signed by the same signing key. In the case of `signatureOrSystem` — only used by the firmware — the app requesting the permission either needs to be signed by the firmware's signing key or reside on the system partition (e.g., come pre-installed with the device).

## Firmware-Only Permissions

Most of Android's permissions mentioned in this book are ones that any SDK application can hold, if they ask for them and the user grants them. INTERNET, READ\_CONTACTS, ACCESS\_FINE\_LOCATION, and kin all are normal permissions.

BRICK is not.

There is a permission in Android, named BRICK, that, in theory, allows an application to render a phone inoperable (a.k.a., “brick” the phone). While there is no `brickMe()` method in the Android SDK tied to this permission, presumably there might be something deep in the firmware that is protected by this permission.

The BRICK permission cannot be held by ordinary Android SDK applications. You can request it all you want, and it will not be granted.

---

## ADVANCED PERMISSIONS

---

However, applications that are signed with the same signing key that signed the firmware *can* hold the BRICK permission.

That is because [the system's own manifest](#) has the following <permission> element:

```
<permission android:name="android.permission.BRICK"
  android:label="@string/permlab_brick"
  android:description="@string/permdesc_brick"
  android:protectionLevel="signature" />
```

Some other permissions have signatureOrSystem instead of signature for android:protectionLevel:

```
<permission android:name="android.permission.REBOOT"
  android:label="@string/permlab_reboot"
  android:description="@string/permdesc_reboot"
  android:protectionLevel="signatureOrSystem" />
```

These permissions can be held by applications that are *either* signed by the firmware's signing key *or* by applications that are installed on the firmware's partition. Mostly, this will be apps that are licensed by a manufacturer or carrier for pre-distribution on a device.

### Your Own Signature Permissions

You too can require signature-level permissions. That will restrict the holders of that permission to be other apps signed by your signing key. This is particularly useful for inter-process communication between apps in a suite — by using signature permissions, you ensure that only your apps will be able to participate in those communications.

This is what was used in the ContentProvider-based plugin sample [from elsewhere in this book](#). The plugin required a permission that was declared with android:protectionLevel="signature", and the host application requested that permission.

One nice thing about these sorts of signature-level permissions is that the user is not bothered with them. It is assumed that the user will agree to the communication between the apps signed by the same signing key. Hence, the user will not see signature-level permissions at install or upgrade time.

Since in some cases, you may not be sure which app will be installed first, it is best to have all apps in the suite include the *same* <permission> element, in addition to

## ADVANCED PERMISSIONS

---

the corresponding `<uses-permission>` element. That way, no matter which app is installed first, it can declare the permission that all will share.

# Tapjacking

---

On the whole, Android's security is fairly good for defending an app from another app. Between using Linux users and filesystems for protecting an application's files from other apps, to the use of custom permissions to control access to public interfaces, an application would seem to be relatively protected.

However, there is one attack vector that existed until Android 4.0.3: tapjacking. This chapter outlines what tapjacking is and what you can do about it to protect your app's users, for as long as you are supporting devices older than 4.0.3.

## Prerequisites

Understanding this chapter requires that you have read the chapters on:

- [broadcast Intents](#)
- [service theory](#)

## What is Tapjacking?

Tapjacking refers to another program intercepting and inspecting touch events that are delivered to your foreground activity (or related artifacts, such as the input method editor). At its worst, tapjackers could intercept passwords, PINs, and other private data.

The term “tapjacking” seems to have been coined by Lookout Mobile Security, in a [blog post](#) that originally demonstrated this issue.

You might be wondering how this is possible. There are a handful of approaches to implementing this. The Lookout blog post cited perhaps the least useful approach: making a transparent Toast. The [Tapjacking/Jackalope](#) sample application will illustrate a far more troublesome implementation.

### World War Z (Axis)

You may recall that there are three axes to consider with Android user interfaces. The X and Y axes are the ones you typically think about, as they control the horizontal and vertical positioning of widgets in an activity. The Z axis — effectively “coming out the screen towards the user’s eyes” — can be used in applications for sophisticated techniques, such as the pop-up panel used in the [maps](#) samples presented elsewhere in this book.

Normally, you think of the Z axis within the scope of your activity and its widgets. However, there are ways to display “system alerts” – widgets that can float over top of any activity. A Toast is the one you are familiar with, most likely. A Toast displays something on the screen, yet touch events on the Toast itself will be passed through to the underlying activity. Lookout demonstrated that it is possible to create a fully-transparent Toast. However, the lifetime of a Toast is limited (3.5 seconds maximum), which would limit how long it can try to grab touch events.

However, any application holding the `SYSTEM_ALERT_WINDOW` permission can display their own “system alerts” with custom look and custom duration. By making one that is fully transparent and lives as long as possible, a tapjacker can obtain touch events for any application in the system, including lock screens, home screens, and any standard activity.

### Enter the Jackalope

To demonstrate this, let’s take a look at the Jackalope sample application. It consists of a tiny activity and a service, with the service doing most of the work.

The activity employs `Theme.NoDisplay`:

```
<?xml version="1.0" encoding="utf-8"?>
<manifest xmlns:android="http://schemas.android.com/apk/res/android"
    android:versionCode="1"
    android:versionName="1.0" package="com.commonware.android.tj.jackalope">
    <uses-permission android:name="android.permission.SYSTEM_ALERT_WINDOW" />
    <application android:label="Jackalope">
        <activity android:name=".Jackalope"
            android:theme="@android:style/Theme.NoDisplay">
```

## TAPJACKING

---

```
        <intent-filter>
            <action android:name="android.intent.action.MAIN" />
            <category android:name="android.intent.category.LAUNCHER" />
        </intent-filter>
    </activity>
    <service android:name=".Tapjacker" />
</application>
</manifest>
```

The activity then just starts up the service and finishes:

```
package com.commonware.android.tj.jackalope;

import android.app.Activity;
import android.content.Intent;
import android.os.Bundle;

public class Jackalope extends Activity {
    @Override
    public void onCreate(Bundle savedInstanceState) {
        super.onCreate(savedInstanceState);

        startService(new Intent(this, Tapjacker.class));
        finish();
    }
}
```

The visible effect is... nothing. Tapping the icon in the launcher appears to have no effect, but it does actually start up the tapjacker. You just cannot see it.

The Tapjacker service does its evil work in a handful of lines of code:

```
package com.commonware.android.tj.jackalope;

import android.app.Service;
import android.content.Intent;
import android.graphics.PixelFormat;
import android.os.IBinder;
import android.util.Log;
import android.view.Gravity;
import android.view.MotionEvent;
import android.view.View;
import android.view.WindowManager;

public class Tapjacker extends Service implements View.OnTouchListener {
    private View v=null;
    private WindowManager mgr=null;

    @Override
    public void onCreate() {
        super.onCreate();
```

## TAPJACKING

---

```
v=new View(this);
v.setOnTouchListener(this);
mgr=(WindowManager) getSystemService(WINDOW_SERVICE);

WindowManager.LayoutParams params
    =new WindowManager.LayoutParams(
        WindowManager.LayoutParams.FILL_PARENT,
        WindowManager.LayoutParams.FILL_PARENT,
        WindowManager.LayoutParams.TYPE_SYSTEM_OVERLAY,
        WindowManager.LayoutParams.FLAG_WATCH_OUTSIDE_TOUCH,
        PixelFormat.TRANSPARENT);

params.gravity=Gravity.FILL_HORIZONTAL|Gravity.FILL_VERTICAL;
mgr.addView(v, params);

// stopSelf(); -- uncomment for "component-less" operation
}

@Override
public IBinder onBind(Intent intent) {
    return(null);
}

@Override
public void onDestroy() {
    mgr.removeView(v); // comment out for "component-less" operation

    super.onDestroy();
}

public boolean onTouch(View v, MotionEvent event) {
    Log.w("Tapjacker",
        String.valueOf(event.getX())+": "+String.valueOf(event.getY()));

    return(false);
}
}
```

In `onCreate()`, we create an invisible `View` in Java code. Note that while you normally create a widget by passing in the `Activity` to the constructor, any `Context` will work, and so here we use the `Tapjacker` service itself.

Then, we access the `WindowManager` system service and add the invisible `View` to the system. To do this, we need to supply a `WindowManager.LayoutParams` object, much like you might use `LinearLayout.LayoutParams` or `RelativeLayout.LayoutParams` when putting a `View` inside of one of those containers. In this case, we:

1. Say that the `View` is to fill the screen

## TAPJACKING

---

2. Indicates that the View is to be treated as a “system overlay” (TYPE\_SYSTEM\_OVERLAY), which will be at the top of the Z axis, floating above anything else (activities, dialogs, etc.)
3. Indicates that we are to receive touch events that are beyond the View itself (FLAG\_WATCH\_OUTSIDE\_TOUCH), such as on the system bar in API Level 11+ devices

We attach the Tapjacker service itself as the `OnTouchListener` to the View, and simply log all touch events to LogCat. In `onDestroy()`, we remove the system overlay View.

The result is that every screen tap results in an entry in LogCat – including data entry via the soft keyboard — even though the user is unaware that anything might be intercepting these events.

Note, though, that this does not intercept regular key events, including those from hardware keyboards. Also note that this does not magically give the malware author access to data entered before the tapjacker was set up. Hence, even if the tapjacker can sniff a password, if they do not know the account name, the user may still be safe.

### Thinking Like a Malware Author

So, you have touch events. On the surface, this might not seem terribly useful, since the View cannot see what is being tapped upon.

However, a savvy malware author would identify what activity is in the foreground and log that information along with the tap details and the screen size, periodically dumping that information to some server. The malware author can then scan the touch event dumps to see what interesting applications are showing up. With a minor investment – and possibly collaboration with other malware authors — the author can know what touch events correspond to what keys on various input method editors, including the stock keyboards used by a variety of devices. Loading a pirated version of the APK on an emulator can indicate which activity has the password, PIN, or other secure data. Then, it is merely a matter of identifying the touch events applied to that activity and matching them up with the soft keyboard to determine what the user has entered. Over time, the malware author can perhaps develop a script to help automate this conversion.



Hence, the on-device tapjacker does not have to be very sophisticated, other than trying to avoid detection by the user. All of the real work to leverage the intercepted touch events can be handled offline.

## Detecting Potential Tapjackers

Tapjacking seems bad.

This raises the question: can we identify when a tapjacker is running? That would allow users and developers to “route around the damage”, such as uninstalling the tapjacker application.

Unfortunately, this does not appear to be possible. There is no obvious way for an application — or the user — to determine if some other application has employed `WindowManager` to add a `TYPE_SYSTEM_OVERLAY` View to the screen. Even if there were, there is no way to determine if this View represents a tapjacker or somebody exploiting this capability for other, less nefarious ends.

All we can do is identify applications that might pose a problem.

### Who Holds a Permission?

The biggest identifier of a possible tapjacker is the `SYSTEM_ALERT_WINDOW` permission. This is required to add a `TYPE_SYSTEM_OVERLAY` View to the screen. Relatively few applications request this, since built-in system alerts, like Toast, do not require the permission.

Also, a tapjacker probably needs the `INTERNET` permission, to deliver the results to the malware author. In principle, the tapjacker could be split into two applications, one with `SYSTEM_ALERT_WINDOW` and one with `INTERNET`. However, this adds to deployment complexity and therefore may be avoided by malware authors.

An end user can use programs like RL Permissions to examine the applications that have these permissions. A developer can use `PackageManager` to enumerate the installed applications and see which ones hold these permissions. We will examine some code for doing this [later in this chapter](#).

### Who is Running?

Of course, a tapjacker is only a threat if it is actually running in the background. Applications might use those two permissions just in the course of normal activity-centric operations, not with an everlasting service trying to maintain the interception View.

We can use `ActivityManager` to enumerate the running processes and what packages' code are in each. Any package that holds the permission combination from the previous section and is running in a process is a possible tapjacking threat. We will examine some code for doing this [in the next section](#).

Note that it is important to examine running processes, not running services. For example, the Tapjacker service from earlier in this chapter could add the interception View and immediately exit. You can see this in action by adjusting the code as indicated in the comments in `onCreate()` and `onDestroy()`. The interception View will remain intact (with the Tapjacker service object leaked) until the process is terminated. That process might be terminated quickly or slowly, depending on what all is going on with the device. A sophisticated malware author might try to run without a running service to increase stealthiness, at the cost of occasionally losing some data.

### Combining the Two: TJDetect

To see these techniques in action, take a look at the [Tapjacking/TJDetect](#) sample project. This consists of a single `ListActivity`, whose list is populated with the applications that hold both `SYSTEM_ALERT_WINDOW` and `INTERNET` permissions and are presently running:

```
package com.commonware.android.tj.detect;

import android.app.ActivityManager;
import android.app.ListActivity;
import android.content.pm.PackageInfo;
import android.content.pm.PackageManager;
import android.os.Bundle;
import android.widget.ArrayAdapter;
import java.util.ArrayList;
import java.util.HashSet;

public class TJDetect extends ListActivity {
    @Override
    public void onCreate(Bundle savedInstanceState) {
        super.onCreate(savedInstanceState);
```

## TAPJACKING

---

```
ActivityManager am=(ActivityManager) getSystemService(ACTIVITY_SERVICE);
HashSet<CharSequence> runningPackages=new HashSet<CharSequence>();

for (ActivityManager.RunningAppProcessInfo proc :
    am.getRunningAppProcesses()) {
    for (String pkgName : proc.pkgList) {
        runningPackages.add(pkgName);
    }
}

PackageManager mgr=getPackageManager();
ArrayList<CharSequence> scary=new ArrayList<CharSequence>();

for (PackageInfo pkg :
    mgr.getInstalledPackages(PackageManager.GET_PERMISSIONS)) {
    if (PackageManager.PERMISSION_GRANTED==
        mgr.checkPermission(android.Manifest.permission.SYSTEM_ALERT_WINDOW,
            pkg.packageName)) {
        if (PackageManager.PERMISSION_GRANTED==
            mgr.checkPermission(android.Manifest.permission.INTERNET,
                pkg.packageName)) {
            if (runningPackages.contains(pkg.packageName)) {
                scary.add(mgr.getApplicationLabel(pkg.applicationInfo));
            }
        }
    }
}

setListAdapter(new ArrayAdapter(this,
    android.R.layout.simple_list_item_1,
    scary));
}
```

To find the unique set of packages that are running across all processes, we iterate over the `RunningAppProcessInfo` objects returned by `ActivityManager` from a call to `getRunningAppProcesses()`. One public data member of `RunningAppProcessInfo` is a list of all the packages whose code runs in this process (`pkgList`). We use a simple `HashSet` to come up with the unique set of packages.

Then, we find all installed packages via a call to `getInstalledPackages()` on `PackageManager`. For each package, we use `checkPermission()` on `PackageManager` to see if the package in question holds a permission. Packages that pass those two tests are then checked against the `HashSet` of running packages, and those that are running are recorded in an `ArrayList`, later wrapped in an `ArrayAdapter`.

If you run `TJDetect`, it will not detect `Jackalope`, since `Jackalope` lacks the `INTERNET` permission. And, particularly on production hardware, it will detect several packages

that may not be tapjackers at all, but rather are system applications installed in the firmware by the device manufacturer.

## Defending Against Tapjackers

OK, so users and developers cannot reliably detect tapjackers. And Android 4.0.3 eliminates this attack vector. Surely, for previous versions of Android, there must be something in the OS that helps defend users and developers against tapjacking, right?

The answer is “yes”, for a generous definition of the term “defend” and an equally generous definition of “users and developers”.

## Filtering Touch Events

The only “defense” directly provided by Android is to allow applications to filter out touch events that had been intercepted by a tapjacker, Toast, or any other form of system overlay or alert. Those touch events are simply dropped, never delivered to the underlying activity.

## Implementing the Filter

The simplest way to implement the touch event filter is to add the `android:filterTouchesWhenObscured` attribute to a widget or container, setting it to `true`. The equivalent Java setter method on `View` is `setFilterTouchesWhenObscured()`.

For example, take a look at the `res/layout/main.xml` file in the [Tapjacking/RelativeSecure](#) sample project:

```
<?xml version="1.0" encoding="utf-8"?>
<RelativeLayout
  xmlns:android="http://schemas.android.com/apk/res/android"
  android:layout_width="match_parent"
  android:layout_height="wrap_content"
  android:filterTouchesWhenObscured="true">
  <TextView android:id="@+id/label"
    android:layout_width="wrap_content"
    android:layout_height="wrap_content"
    android:text="URL:"
    android:layout_alignBaseline="@+id/entry"
    android:layout_alignParentLeft="true"/>
  <EditText
```

```
    android:id="@id/entry"
    android:layout_width="match_parent"
    android:layout_height="wrap_content"
    android:layout_toRightOf="@id/label"
    android:layout_alignParentTop="true" />
<Button
    android:id="@+id/ok"
    android:layout_width="wrap_content"
    android:layout_height="wrap_content"
    android:layout_below="@id/entry"
    android:layout_alignRight="@id/entry"
    android:text="OK" />
<Button
    android:id="@+id/cancel"
    android:layout_width="wrap_content"
    android:layout_height="wrap_content"
    android:layout_toLeftOf="@id/ok"
    android:layout_alignTop="@id/ok"
    android:text="Cancel" />
</RelativeLayout>
```

Here, we have `android:filterTouchesWhenObscured="true"` on the `RelativeLayout` at the root of the layout resource. This property cascades to a container's children, and so if a tapjacker (or `Toast` or whatever) is above any of the widgets in the `RelativeLayout`, none of the touch events will be processed.

More fine-grained control can be achieved in custom widgets by overriding `onFilterTouchEventForSecurity()`, which gets control before the regular touch event methods. You can determine if a touch event had been intercepted by looking for the `FLAG_WINDOW_IS_OBSCURED` flag in the `MotionEvent` passed to `onFilterTouchEventForSecurity()`, and you can make the decision of how to handle this on an event-by-event basis.

### The User Experience and the Hoped-For Security

Normally, the user will not see a difference when interacting with widgets that have this attribute set. However, if a tapjacker is intercepting these events, the user will not see any reaction from the widgets when they are tapped. For example, clicking a `Button` will have no visual effect (e.g., orange flash).

The hope is that users will realize that the UI is not responding to their touch events and therefore will not complete whatever it is they are doing. For example, they might not complete their PIN entry after realizing that the number pad supplied by the app is not responding to their taps.

For some users and some apps, this will be an effective defense. However, there will be some users who will remain oblivious until after completing the attempt to enter the private information.

### The Flaws

The user can still use the soft keyboard to enter data into `EditText` widgets. While the soft keyboard will not automatically appear in portrait mode (since the `EditText` will not respond to the tap), if it has the focus, the user can long-press the MENU button to raise the soft keyboard and enter data that way.

Similarly, if the user is in landscape mode and gets the full-screen soft keyboard, since this is not the `EditText` widget defended by the touch event filtering, everything works normally — including interception by tapjacking. Developers could try to prevent this by adding `flagNoFullscreen` to the `android:imeOptions` attribute on the `EditText` in the layout XML, though this may not be honored by all soft keyboards. Developers could also try to prevent this by locking the activity into portrait mode (`android:screenOrientation="portrait"`), but this would be bad for users with side-slider keyboards, Google TV devices, etc.

And, most importantly, the tapjacking still happens. If users keep trying to enter their credentials despite the lack of UI feedback, they may eventually enter the whole thing and therefore become vulnerable to having that information used for ill ends.

### Availability

Filtering touch events when the activity is obscured is supported in API Level 9 and above — in other words, Android 2.3 and newer. At the time of this writing, that leaves out ~25% of active Android devices, based on the June 1, 2012 published edition of the [platform versions data](#) from Google.

### Detect-and-Warn

You can use the tapjacker detection logic illustrated earlier in this chapter. It is not particularly accurate, but you may feel it is worthwhile.

To minimize hassle for the user, your application should maintain a “whitelist” of approved packages. Any time you detect a package that is not on the approved list, you would raise an `AlertDialog` (or the equivalent) to let the user know of the

potential tapjacker. If they elect to continue onward in your app, add the new package(s) to the whitelist, so you do not bother the user again for the same package.

### Why Is This Being Discussed?

Some of you are by this time wondering why this book has a chapter on this subject.

Google's security team indicated to the author that `android:filterTouchesWhenObscured` is sufficient security. If so, developers need to realize when to use it, and for that, developers need to understand what tapjacking is to start with. The code to implement tapjacking is sufficiently trivial that "security by obscurity" of the code seems pointless.

It is eminently possible that `android:filterTouchesWhenObscured` is not sufficient security, despite Google's claim. Since Google seems to have changed their mind, eliminating tapjacking in Android 4.0.3, it would appear that Google thinks that Google's original solution was insufficient. In that case, developers may be able to help inform the public about the dangers of applications that request the `SYSTEM_ALERT_WINDOW` permission.

There are legitimate uses for tapjacking techniques. Some apps use this to provide a universal gesture interface, for example, to get control no matter what application is presently in the foreground. Whether the value that such apps provide is worth the risks inherent in tapjacking is up for debate.

If you feel that tapjacking is a problem and that `android:filterTouchesWhenObscured` is inadequate, you may wish to let Google know when you have the opportunity to interact with Google engineers at conferences and similar events. If you come up with other ways to detect and/or prevent tapjacking, you may wish to distribute that knowledge, so other developers can learn from your discovery.

### What Changed in 4.0.3?

As of Android 4.0.3, the tapjacking attack is no longer possible, at least through the techniques outlined in this chapter. A `View` of type `TYPE_SYSTEM_OVERLAY` cannot receive touch events.

# Accessing Location-Based Services

---

A popular feature on current-era mobile devices is GPS capability, so the device can tell you where you are at any point in time. While the most popular use of GPS service is mapping and directions, there are other things you can do if you know your location. For example, you might set up a dynamic chat application where the people you can chat with are based on physical location, so you are chatting with those you are nearest. Or, you could automatically “geotag” posts to Twitter or similar services.

GPS is not the only way a mobile device can identify your location. Alternatives include:

1. The European equivalent to GPS, called Galileo, which is still under development at the time of this writing
2. Cell tower triangulation, where your position is determined based on signal strength to nearby cell towers
3. Proximity to public WiFi “hotspots” that have known geographic locations

Android devices may have one or more of these services available to them. You, as a developer, can ask the device for your location, plus details on what providers are available. There are even ways for you to simulate your location in the emulator, for use in testing your location-enabled applications.

## Prerequisites

Understanding this chapter requires that you have read the core chapters, particularly the [chapter on threads](#).



## Location Providers: They Know Where You're Hiding

Android devices can have access to several different means of determining your location. Some will have better accuracy than others. Some may be free, while others may have a cost associated with them. Some may be able to tell you more than just your current position, such as your elevation over sea level, or your current speed.

Android, therefore, has abstracted all this out into a set of `LocationProvider` objects. Your Android environment will have zero or more `LocationProvider` instances, one for each distinct locating service that is available on the device. Providers know not only your location, but also their own characteristics, in terms of accuracy, cost, etc.

You, as a developer, will use a `LocationManager`, which holds the `LocationProvider` set, to figure out which `LocationProvider` is right for your particular circumstance. You will also need a permission in your application, or the various location APIs will fail due to a security violation. Depending on which location providers you wish to use, you may need `ACCESS_COARSE_LOCATION`, `ACCESS_FINE_LOCATION`, or both. Note that `ACCESS_COARSE_LOCATION` may intentionally filter out location fixes that are “too good” (i.e., more accurate than a city block).

## Finding Yourself

The obvious thing to do with a location service is to figure out where you are right now.

To do that, you need to get a `LocationManager` — call `getSystemService(LOCATION_SERVICE)` from your activity or service and cast it to be a `LocationManager`.

The next step to find out where you are is to get the name of the `LocationProvider` you want to use. Here, you have two main options:

- Ask the user to pick a provider
- Find the best-match provider based on a set of criteria

## ACCESSING LOCATION-BASED SERVICES

---

If you want the user to pick a provider, calling `getProviders()` on the `LocationManager` will give you a `List` of providers, which you can then present to the user for selection.

Or, you can create and populate a `Criteria` object, stating the particulars of what you want out of a `LocationProvider`, such as:

1. `setAltitudeRequired()` to indicate if you need the current altitude or not
2. `setAccuracy()` to set a minimum level of accuracy, in meters, for the position
3. `setCostAllowed()` to control if the provider must be free or if it can incur a cost on behalf of the device user

Given a filled-in `Criteria` object, call `getBestProvider()` on your `LocationManager`, and Android will sift through the criteria and give you the best answer. Note that not all of your criteria may be met – all but the monetary cost criterion might be relaxed if nothing matches.

You are also welcome to hard-wire in a `LocationProvider` name (e.g., `GPS_PROVIDER`), perhaps just for testing purposes.

Once you know the name of the `LocationProvider`, you can call `getLastKnownLocation()` to find out where you were recently. However, unless something else is causing the desired provider to collect fixes (e.g., unless the GPS radio is on), `getLastKnownLocation()` will return `null`, indicating that there is no known position. On the other hand, `getLastKnownLocation()` incurs no monetary or power cost, since the provider does not need to be activated to get the value.

These methods return a `Location` object, which can give you the latitude and longitude of the device in degrees as a Java `double`. If the particular location provider offers other data, you can get at that as well:

1. For altitude, `hasAltitude()` will tell you if there is an altitude value, and `getAltitude()` will return the altitude in meters.
2. For bearing (i.e., compass-style direction), `hasBearing()` will tell you if there is a bearing available, and `getBearing()` will return it as degrees east of true north.
3. For speed, `hasSpeed()` will tell you if the speed is known and `getSpeed()` will return the speed in meters per second.

A more likely approach to getting the `Location` from a `LocationProvider`, though, is to register for updates, as described in the next section.

### On the Move

Not all location providers are necessarily immediately responsive. GPS, for example, requires activating a radio and getting a fix from the satellites before you get a location. That is why Android does not offer a `getMeMyCurrentLocationNow()` method. Combine that with the fact that your users may well want their movements to be reflected in your application, and you are probably best off registering for location updates and using that as your means of getting the current location.

The [Internet/Weather](#) sample application shows how to register for updates — call `requestLocationUpdates()` on your `LocationManager` instance. This takes four parameters:

- The name of the location provider you wish to use
- How long, in milliseconds, *should* have elapsed before we might get a location update
- How far, in meters, must the device have moved before we might get a location update
- An implementation of the `LocationListener` interface that will be notified of key location-related events

`LocationListener` requires four methods, the big one being `onLocationChanged()`, where you will receive your `Location` object when an update is ready:

```
@Override
public void onLocationChanged(Location location) {
    FetchForecastTask task=new FetchForecastTask();

    task.execute(location);
}
```

Bear in mind that the time parameter is only a guide to help steer Android from a power consumption standpoint. You may get many more location updates than this. To get the maximum number of location updates, supply 0 for both the time and distance constraints.

When you no longer need the updates, call `removeUpdates()` with the `LocationListener` you registered. If you fail to do this, your application will

continue receiving location updates even after all activities and such are closed up, which will also prevent Android from reclaiming your application's memory.

There is another version of `requestLocationUpdates()` that takes a `PendingIntent` rather than a `LocationListener`. This is useful if you want to be notified of changes in your position even when your code is not running. For example, if you are logging movements, you could use a `PendingIntent` that triggers a `BroadcastReceiver` (`getBroadcast()`) and have the `BroadcastReceiver` add the entry to the log. This way, your code is only in memory when the position changes, so you do not tie up system resources while the device is not moving.

## Are We There Yet? Are We There Yet? Are We There Yet?

Sometimes, you want to know not where you are now, or even when you move, but when you get to where you are going. This could be an end destination, or it could be getting to the next step on a set of directions, so you can give the user the next turn.

To accomplish this, `LocationManager` offers `addProximityAlert()`. This registers an `PendingIntent`, which will be fired off when the device gets within a certain distance of a certain location. The `addProximityAlert()` method takes, as parameters:

1. The latitude and longitude of the position that you are interested in
2. A radius, specifying how close you should be to that position for the Intent to be raised
3. A duration for the registration, in milliseconds — after this period, the registration automatically lapses. A value of -1 means the registration lasts until you manually remove it via `removeProximityAlert()`.
4. The `PendingIntent` to be raised when the device is within the “target zone” expressed by the position and radius

Note that it is not guaranteed that you will actually receive an Intent, if there is an interruption in location services, or if the device is not in the target zone during the period of time the proximity alert is active. For example, if the position is off by a bit, and the radius is a little too tight, the device might only skirt the edge of the target zone, or go by so quickly that the device's location isn't sampled while in the target zone.

It is up to you to arrange for an activity or receiver to respond to the Intent you register with the proximity alert. What you then do when the Intent arrives is up to you: set up a notification (e.g., vibrate the device), log the information to a content provider, post a message to a Web site, etc. Note that you will receive the Intent whenever the position is sampled and you are within the target zone – not just upon entering the zone. Hence, you will get the Intent several times, perhaps quite a few times depending on the size of the target zone and the speed of the device's movement.

### Testing... Testing...

The Android emulator does not have the ability to get a fix from GPS, triangulate your position from cell towers, or identify your location by some nearby WiFi signal. So, if you want to simulate a moving device, you will need to have some means of providing mock location data to the emulator.

For whatever reason, this particular area has undergone significant changes as Android itself has evolved. It used to be that you could provide mock location data within your application, which was very handy for demonstration purposes. Alas, those options have all been removed as of Android 1.0.

One likely option for supplying mock location data is the Dalvik Debug Monitor Service (DDMS). This is an external program, separate from the emulator, where you can feed it single location points or full routes to traverse, in a few different formats, as is mentioned in [the chapter on DDMS](#).

You can also send location fixes via `telnet` to an emulator. The port number is in your emulator's title bar (usually 5554 for the first running emulator instance). You can then run:

```
telnet localhost 5554
```

to access the Android Console within the emulator. Running the `geo fix NNN NNN` command, where `NNN NNN` is your latitude and longitude, will have the emulator respond as if those coordinates came from GPS.

## Alternative Flavors of Updates

There are more ways to get updates from `LocationManager` than the versions of `requestLocationUpdates()` we have seen so far. There are four major axes of difference:

1. Some versions of `requestLocationUpdates()` take a `Criteria` object, having Android give you fixes based on the best-available provider given the requirements stipulated in the `Criteria`
2. Some versions of `requestLocationUpdates()` take a `Looper` as a parameter, allowing you to receive updates on a background `HandlerThread` instead of the main application thread
3. Some versions of `requestLocationUpdates()` take a `PendingIntent` which will be executed, instead of calling your `LocationListener`
4. There are a few flavors of `getSingleUpdate()`, which, as the name suggests, gives you just one location fix, rather than a stream until you remove the request for updates

For the `Criteria`-flavored versions of `requestLocationUpdates()` and `requestSingleUpdate()`, bear in mind that your code will still crash if there are no possible providers for your `Criteria`. For example, even if you use an empty `Criteria` object (for maximum possible matches), but GPS is disabled and the device lacks telephony (e.g., a tablet), you can get a crash like this one:

```
02-09 13:29:21.549: E/AndroidRuntime(2236): FATAL EXCEPTION: main
02-09 13:29:21.549: E/AndroidRuntime(2236): java.lang.RuntimeException: Unable
to resume activity {com.commonware.android.mapsv2.location/
com.commonware.android.mapsv2.location.MainActivity}:
java.lang.IllegalArgumentException: no providers found for criteria
02-09 13:29:21.549: E/AndroidRuntime(2236): at
android.app.ActivityThread.performResumeActivity(ActivityThread.java:2564)
02-09 13:29:21.549: E/AndroidRuntime(2236): at
android.app.ActivityThread.handleResumeActivity(ActivityThread.java:2607)
02-09 13:29:21.549: E/AndroidRuntime(2236): at
android.app.ActivityThread.handleLaunchActivity(ActivityThread.java:2088)
02-09 13:29:21.549: E/AndroidRuntime(2236): at
android.app.ActivityThread.access$600(ActivityThread.java:134)
02-09 13:29:21.549: E/AndroidRuntime(2236): at
android.app.ActivityThread$H.handleMessage(ActivityThread.java:1233)
02-09 13:29:21.549: E/AndroidRuntime(2236): at
android.os.Handler.dispatchMessage(Handler.java:99)
02-09 13:29:21.549: E/AndroidRuntime(2236): at
android.os.Looper.loop(Looper.java:137)
02-09 13:29:21.549: E/AndroidRuntime(2236): at
android.app.ActivityThread.main(ActivityThread.java:4699)
02-09 13:29:21.549: E/AndroidRuntime(2236): at
```

## ACCESSING LOCATION-BASED SERVICES

---

```
java.lang.reflect.Method.invokeNative(Native Method)
02-09 13:29:21.549: E/AndroidRuntime(2236): at
java.lang.reflect.Method.invoke(Method.java:511)
02-09 13:29:21.549: E/AndroidRuntime(2236): at
com.android.internal.os.ZygoteInit$MethodAndArgsCaller.run(ZygoteInit.java:787)
02-09 13:29:21.549: E/AndroidRuntime(2236): at
com.android.internal.os.ZygoteInit.main(ZygoteInit.java:554)
02-09 13:29:21.549: E/AndroidRuntime(2236): at
dalvik.system.NativeStart.main(Native Method)
02-09 13:29:21.549: E/AndroidRuntime(2236): Caused by:
java.lang.IllegalArgumentException: no providers found for criteria
02-09 13:29:21.549: E/AndroidRuntime(2236): at
android.os.Parcel.readException(Parcel.java:1331)
02-09 13:29:21.549: E/AndroidRuntime(2236): at
android.os.Parcel.readException(Parcel.java:1281)
02-09 13:29:21.549: E/AndroidRuntime(2236): at
android.location.ILocationManager$Stub$Proxy.requestLocationUpdates(ILocationManager.java:646)
02-09 13:29:21.549: E/AndroidRuntime(2236): at
android.location.LocationManager._requestLocationUpdates(LocationManager.java:618)
02-09 13:29:21.549: E/AndroidRuntime(2236): at
android.location.LocationManager.requestLocationUpdates(LocationManager.java:599)
02-09 13:29:21.549: E/AndroidRuntime(2236): at
com.commonware.android.mapsv2.location.MainActivity.onResume(MainActivity.java:101)
02-09 13:29:21.549: E/AndroidRuntime(2236): at
android.app.Instrumentation.callActivityOnResume(Instrumentation.java:1154)
02-09 13:29:21.549: E/AndroidRuntime(2236): at
android.app.Activity.performResume(Activity.java:4616)
02-09 13:29:21.549: E/AndroidRuntime(2236): at
android.app.ActivityThread.performResumeActivity(ActivityThread.java:2546)
02-09 13:29:21.549: E/AndroidRuntime(2236): ... 12 more
```

Hence, you will still want to use `getProviders()` or `getBestProvider()` to ensure that your Criteria will resolve to *something* before you try using the Criteria to actually request fixes.

# Working with the Clipboard

---

Being able to copy and paste is something that mobile device users seem to want almost as much as their desktop brethren. Most of the time, we think of this as copying and pasting text, and for a long time that was all that was possible on Android. Android 3.0 added in new clipboard capabilities for more rich content, which application developers can choose to support as well. This section will cover both of these techniques.

## Prerequisites

Understanding this chapter requires that you have read the core chapters of this book.

## Using the Clipboard on Android 1.x/2.x

Android has a `ClipboardManager` that allows you to interact with the clipboard manually, in addition to built-in clipboard facilities for users (e.g., copy/paste context menus on `EditText`). `ClipboardManager`, like `AudioManager`, is obtained via a call to `getSystemService()`:

```
ClipboardManager  
cm=(ClipboardManager)getSystemService(CLIPBOARD_SERVICE);
```

From there, you have three simple methods:

1. `getText()` to retrieve the current clipboard contents
2. `hasText()`, to determine if there are any clipboard contents, so you can react accordingly (e.g., disable “paste” menus when there is nothing to paste)
3. `setText()`, to put text on the clipboard



## WORKING WITH THE CLIPBOARD

---

For example, the [SystemServices/ClipIP](#) sample project contains a little application that puts your current IP address on the clipboard, for pasting into some EditText of an application. The UI is simply an EditText that you can use to test out the paste operation:

```
<?xml version="1.0" encoding="utf-8"?>
<LinearLayout xmlns:android="http://schemas.android.com/apk/res/android"
    android:orientation="vertical"
    android:layout_width="fill_parent"
    android:layout_height="fill_parent"
    >
<EditText
    android:layout_width="fill_parent"
    android:layout_height="wrap_content"
    android:hint="Long-tap me to paste!"
    />
</LinearLayout>
```

The IPClipper activity's onCreate() does the work of putting text onto the clipboard via setText() and notifying the user via a Toast:

```
@Override
public void onCreate(Bundle savedInstanceState) {
    super.onCreate(savedInstanceState);
    setContentView(R.layout.main);

    try {
        String addr=getLocalIPAddress();

        if (addr==null) {
            Toast.makeText(this,
                "IP address not available -- are you online?",
                Toast.LENGTH_LONG)
                .show();
        }
        else {
            ClipboardManager
cm=(ClipboardManager) getSystemService(CLIPBOARD_SERVICE);

            cm.setText(addr);
            Toast.makeText(this, "IP Address clipped!", Toast.LENGTH_SHORT)
                .show();
        }
    }
    catch (Exception e) {
        Log.e("IPClipper", "Exception getting IP address", e);
        Toast.makeText(this,
            "Could not obtain IP address",
            Toast.LENGTH_LONG)
            .show();
    }
}
```

## WORKING WITH THE CLIPBOARD

---

```
}  
}
```

The work of figuring out what the IP address is can be found in the `getLocalIPAddress()` method:

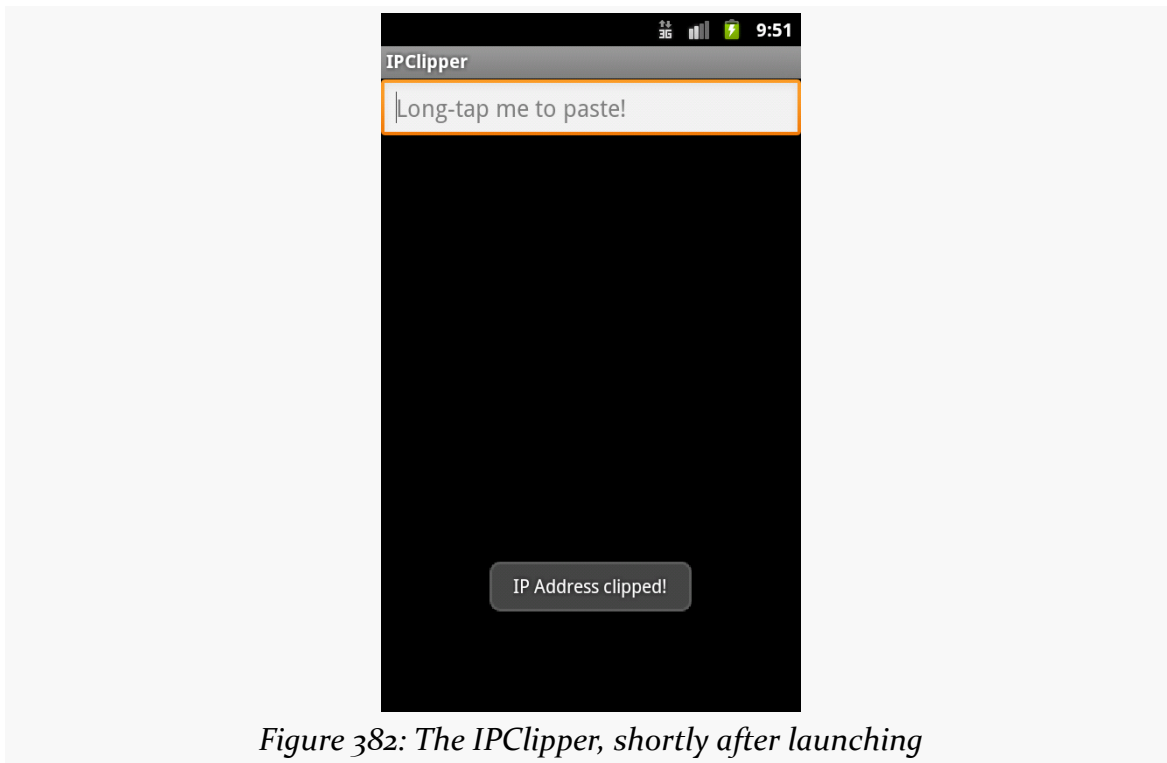
```
public String getLocalIPAddress() throws SocketException {  
    Enumeration<NetworkInterface> nics=NetworkInterface.getNetworkInterfaces();  
  
    while (nics.hasMoreElements()) {  
        NetworkInterface intf=nics.nextElement();  
        Enumeration<InetAddress> addrs=intf.getInetAddresses();  
  
        while (addrs.hasMoreElements()) {  
            InetAddress addr=addrs.nextElement();  
  
            if (!addr.isLoopbackAddress()) {  
                return(addr.getHostAddress().toString());  
            }  
        }  
    }  
  
    return(null);  
}
```

This uses the `NetworkInterface` and `InetAddress` classes from the `java.net` package to loop through all network interfaces and find the first one that has a non-localhost (loopback) IP address. The emulator will return `10.0.2.15` all of the time; your device will return whatever IP address it has from WiFi, 3G, etc. If no such address is available, it returns `null`.

After starting the activity, the user will hopefully see the “successful” Toast:

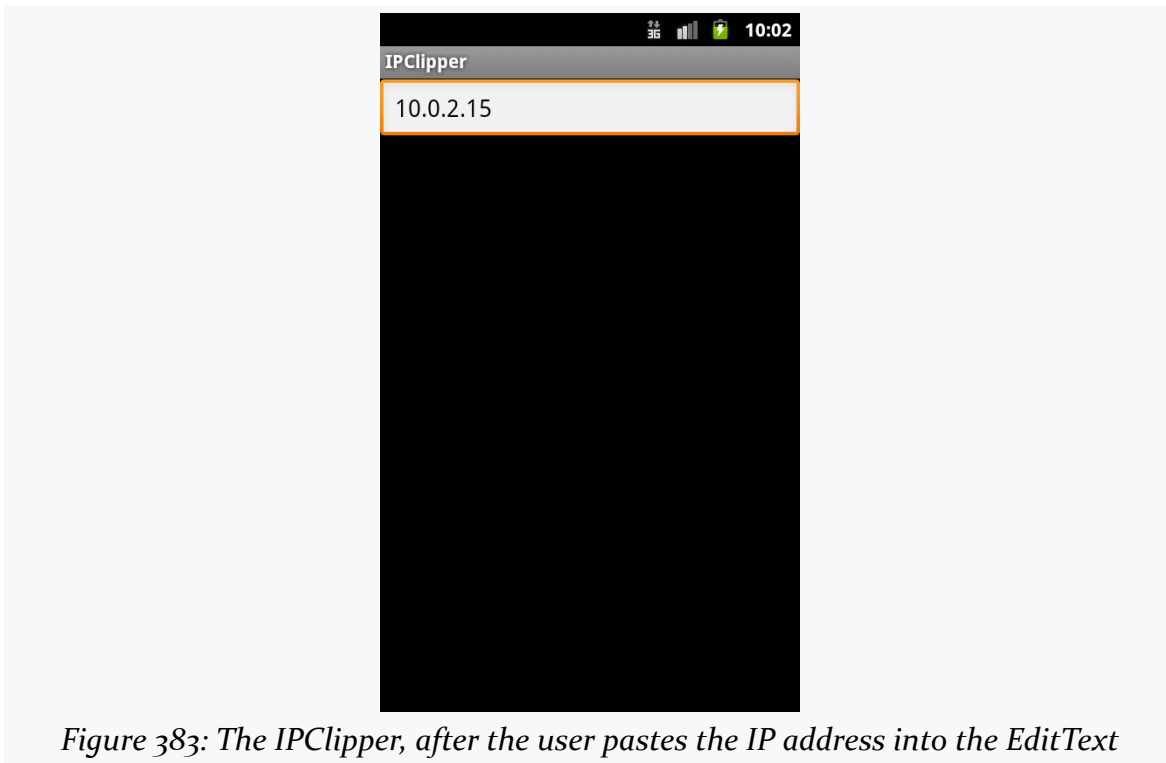
## WORKING WITH THE CLIPBOARD

---



*Figure 382: The IPClipper, shortly after launching*

Then, if the user long-taps on the EditText and chooses Paste, the IP address is added to the EditText contents:



*Figure 383: The IPClipper, after the user pastes the IP address into the EditText*

Note that the clipboard is system-wide, not merely application-wide. You can test this by pasting the IP address into the `EditText` of some other application.

### Advanced Clipboard on Android 3.x

Android 3.0 added in new ways of working with `ClipboardManager` to clip things that transcend simple text. In part, this is expected to be used for advanced copy and paste features between applications. However, this also forms the foundation for a rich drag-and-drop model within an application.

Note that they also moved `ClipboardManager` to the `android.content` package. You can still refer to it via the `android.text` package, for backwards compatibility. However, if your project will be on API Level 11 or higher only, you might consider using the new `android.content` package edition of the class.

### Copying Rich Data to the Clipboard

In addition to methods like `setText()` to put a piece of plain text on the clipboard, `ClipboardManager` (as of API Level 11) offers `setPrimaryClip()`, which allows you to put a `ClipData` object on the clipboard.

What's a `ClipData`? In some respects, it is whatever you want. It can hold:

1. plain text
2. a `Uri` (e.g., to a piece of music)
3. an `Intent`

The `Uri` means that you can put anything on the clipboard that can be referenced by a `Uri`... and if there is nothing in Android that lets you reference some data via a `Uri`, you can invent your own content provider to handle that chore for you.

Furthermore, a single `ClipData` can actually hold as many of these as you want, each represented as individual `ClipData.Item` objects. As such, the possibilities are endless.

There are static factory methods on `ClipData`, such as `newUri()`, that you can use to create your `ClipData` objects. In fact, that is what we use in the [SystemServices/ClipMusic](#) sample project and the `MusicClipper` activity.

`MusicClipper` has the classic two-big-button layout:

```
<?xml version="1.0" encoding="utf-8"?>
<LinearLayout xmlns:android="http://schemas.android.com/apk/res/android"
    android:orientation="vertical"
    android:layout_width="fill_parent"
    android:layout_height="fill_parent"
    >
    <Button android:id="@+id/pick"
        android:layout_width="fill_parent"
        android:layout_height="fill_parent"
        android:layout_weight="1"
        android:text="Pick"
        android:onClick="pickMusic"
    />
    <Button android:id="@+id/view"
        android:layout_width="fill_parent"
        android:layout_height="fill_parent"
        android:layout_weight="1"
        android:text="Play"
        android:onClick="playMusic"
    />
</LinearLayout>
```

## WORKING WITH THE CLIPBOARD

---

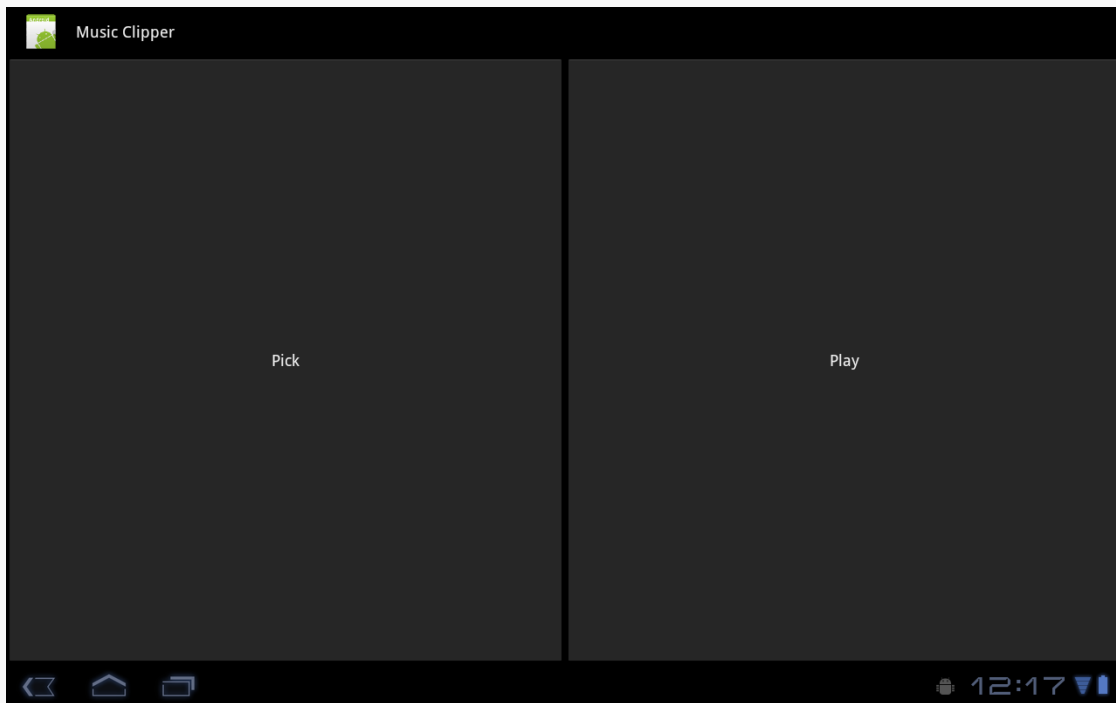


Figure 384: The Music Clipper main screen

In `onCreate()`, we get our hands on our `ClipboardManager` system service:

```
@Override
public void onCreate(Bundle savedInstanceState) {
    super.onCreate(savedInstanceState);
    setContentView(R.layout.main);

    clipboard=(ClipboardManager) getSystemService(CLIPBOARD_SERVICE);
}
```

Tapping the “Pick” button will let you pick a piece of music, courtesy of the `pickMusic()` method wired to that `Button` object:

```
public void pickMusic(View v) {
    Intent i=new Intent(Intent.ACTION_GET_CONTENT);

    i.setType("audio/*");
    startActivityForResult(i, PICK_REQUEST);
}
```

Here, we tell Android to let us pick a piece of music from any available audio MIME type (`audio/*`). Fortunately, Android has an activity that lets us do that:

## WORKING WITH THE CLIPBOARD

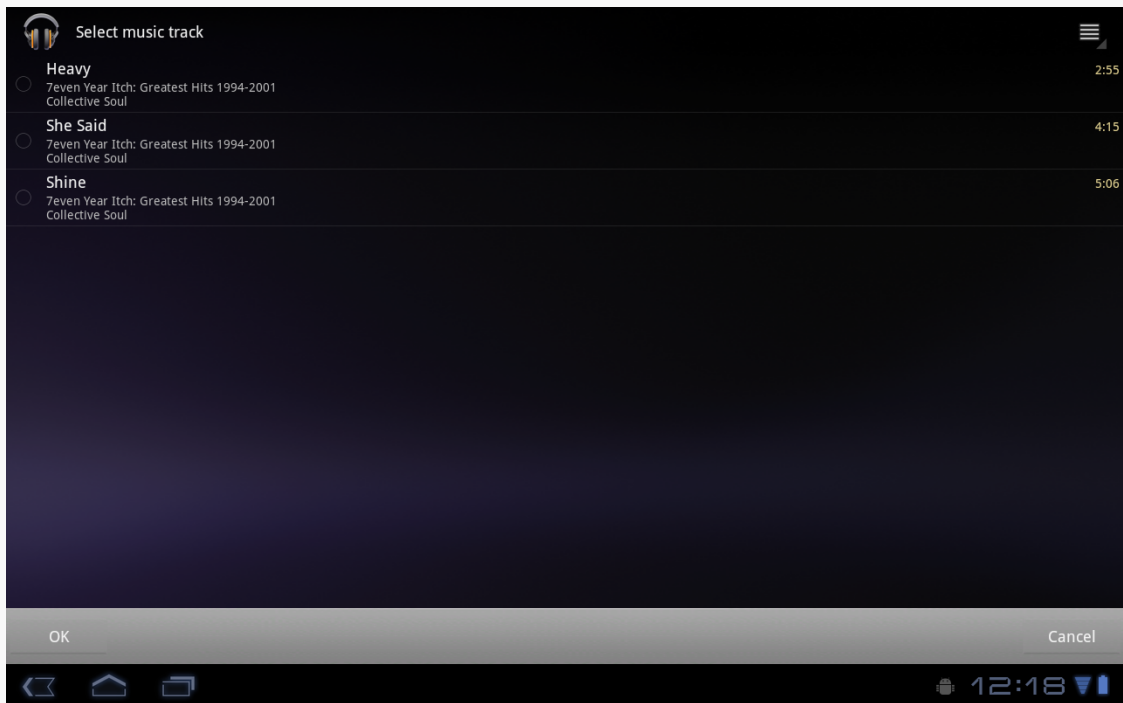


Figure 385: The XOOM tablet's music track picker

We get the result in `onActivityResult()`, since we used `startActivityForResult()` to pick the music. There, we package up the content:// Uri to the music into a `ClipData` object and put it on the clipboard:

```
@Override
protected void onActivityResult(int requestCode, int resultCode,
                                Intent data) {
    if (requestCode==PICK_REQUEST) {
        if (resultCode==RESULT_OK) {
            ClipData clip=ClipData.newUri(getContentResolver(),
                                           "Some music", data.getData());

            clipboard.setPrimaryClip(clip);
        }
    }
}
```

### Pasting Rich Data from the Clipboard

The catch with rich data on the clipboard is that somebody has to know about the sort of information you are placing on the clipboard. Eventually, the Android development community will work out common practices in this area. Right now,

## WORKING WITH THE CLIPBOARD

---

though, you can certainly use it within your own application (e.g., clipping a note and pasting it into another folder).

Since putting `ClipData` onto the clipboard involves a call to `setPrimaryClip()`, it should not be surprising that the reverse operation — getting a `ClipData` from the clipboard — uses `getPrimaryClip()`. However, since you do not know where this clip came from, you need to validate that it has what you expect and to let the user know when the clipboard contents are not something you can leverage.

The “Play” button in our UI is wired to a `playMusic()` method. This will only work when we have pasted a `Uri` `ClipData` to the clipboard pointing to a piece of music. Since we cannot be sure that the user has done that, we have to sniff around:

```
public void playMusic(View v) {
    ClipData clip=clipboard.getPrimaryClip();

    if (clip==null) {
        Toast.makeText(this, "There is no clip!", Toast.LENGTH_LONG).show();
    }
    else {
        ClipData.Item item=clip.getItemAt(0);
        Uri song=item.getUri();

        if (song!=null &&
            getContentResolver().getType(song).startsWith("audio/")) {
            startActivity(new Intent(Intent.ACTION_VIEW, song));
        }
        else {
            Toast.makeText(this, "There is no song!", Toast.LENGTH_LONG).show();
        }
    }
}
```

First, there may be nothing on the clipboard, in which case the `ClipData` returned by `getPrimaryClip()` would be `null`. Or, there may be stuff on the clipboard, but it may not have a `Uri` associated with it (`getUri()` on `ClipData`). Even then, the `Uri` may point to something other than music, so even if we get a `Uri`, we need to use a `ContentResolver` to check the MIME type (`getContentResolver().getType()`) and make sure it seems like it is music (e.g., starts with `audio/`). Then, and only then, does it make sense to try to start an `ACTION_VIEW` activity on that `Uri` and hope that something useful happens. Assuming you clipped a piece of music with the “Pick” button, “Play” will kick off playback of that song.



### ClipData and Drag-and-Drop

Android 3.0 also introduced Android's first built-in drag-and-drop framework. One might expect that this would related entirely to View and ViewGroup objects and have nothing to do with the clipboard. In reality, the drag-and-drop framework leverages ClipData to say what it is that is being dragged and dropped. You call `startDrag()` on a View, supplying a ClipData object, along with some objects to help render the "shadow" that is the visual representation of this drag operation. A View that can receive objects "dropped" via drag-and-drop needs to register an `OnDragListener` to receive drag events as the user slides the shadow over top of the View in question. If the user lifts their finger, thereby dropping the shadow, the recipient View will get an `ACTION_DROP` drag event, and can get the ClipData out of the event.

# Telephony

---

Many, if not most, Android devices will be phones. As such, not only will users be expecting to place and receive calls using Android, but you will have the opportunity to help them place calls, if you wish.

Why might you want to?

1. Maybe you are writing an Android interface to a sales management application (a la Salesforce.com) and you want to offer users the ability to call prospects with a single button click, and without them having to keep those contacts both in your application and in the phone's contacts application
2. Maybe you are writing a social networking application, and the roster of phone numbers that you can access shifts constantly, so rather than try to "sync" the social network contacts with the phone's contact database, you let people place calls directly from your application
3. Maybe you are creating an alternative interface to the existing contacts system, perhaps for users with reduced motor control (e.g., the elderly), sporting big buttons and the like to make it easier for them to place calls

Whatever the reason, Android has the means to let you manipulate the phone just like any other piece of the Android system.

## Prerequisites

Understanding this chapter requires that you have read the core chapters, particularly the [chapter on working with multiple activities](#).

## Report To The Manager

To get at much of the phone API, you use the `TelephonyManager`. That class lets you do things like:

1. Determine if the phone is in use via `getCallState()`, with return values of `CALL_STATE_IDLE` (phone not in use), `CALL_STATE_RINGING` (call requested but still being connected), and `CALL_STATE_OFFHOOK` (call in progress)
2. Find out the SIM ID (IMSI) via `getSubscriberId()`
3. Find out the phone type (e.g., GSM) via `getPhoneType()` or find out the data connection type (e.g., GPRS, EDGE) via `getNetworkType()`

## You Make the Call!

You can also initiate a call from your application, such as from a phone number you obtained through your own Web service. To do this, simply craft an `ACTION_DIAL` Intent with a `Uri` of the form `tel:NNNNN` (where `NNNNN` is the phone number to dial) and use that Intent with `startActivity()`. This will not actually dial the phone; rather, it activates the dialer activity, from which the user can then press a button to place the call.

For example, let's look at the [Phone/Dialer](#) sample application. Here's the crude-but-effective layout:

```
<?xml version="1.0" encoding="utf-8"?>
<LinearLayout xmlns:android="http://schemas.android.com/apk/res/android"
    android:orientation="vertical"
    android:layout_width="fill_parent"
    android:layout_height="fill_parent"
    >
    <LinearLayout
        android:orientation="horizontal"
        android:layout_width="fill_parent"
        android:layout_height="wrap_content"
        >
        <TextView
            android:layout_width="wrap_content"
            android:layout_height="wrap_content"
            android:text="Number to dial:"
            />
        <EditText android:id="@+id/number"
            android:layout_width="fill_parent"
            android:layout_height="wrap_content"
            android:cursorVisible="true"
            android:editable="true"
```

```
        android:singleLine="true"
    />
</LinearLayout>
<Button android:id="@+id/dial"
    android:layout_width="fill_parent"
    android:layout_height="wrap_content"
    android:layout_weight="1"
    android:text="Dial It!"
    android:onClick="dial"
/>
</LinearLayout>
```

We have a labeled field for typing in a phone number, plus a button for dialing said number.

The Java code simply launches the dialer using the phone number from the field:

```
package com.commonsware.android.dialer;

import android.app.Activity;
import android.content.Intent;
import android.net.Uri;
import android.os.Bundle;
import android.view.View;
import android.widget.EditText;

public class DialerDemo extends Activity {
    @Override
    public void onCreate(Bundle savedInstanceState) {
        super.onCreate(savedInstanceState);
        setContentView(R.layout.main);
    }

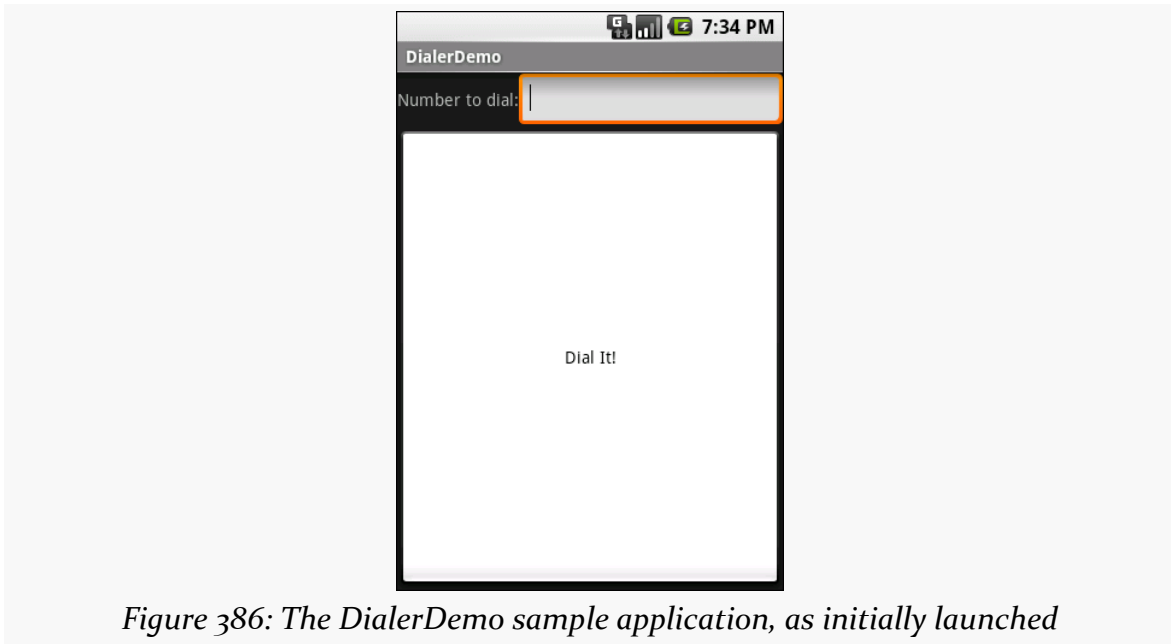
    public void dial(View v) {
        EditText number=(EditText)findViewById(R.id.number);
        String toDial="tel:"+number.getText().toString();

        startActivity(new Intent(Intent.ACTION_DIAL, Uri.parse(toDial)));
    }
}
```

The activity's own UI is not that impressive:

## TELEPHONY

---



*Figure 386: The DialerDemo sample application, as initially launched*

However, the dialer you get from clicking the dial button is better, showing you the number you are about to dial:



*Figure 387: The Android Dialer activity, as launched from DialerDemo*

## No, Really, You Make the Call!

The good news is that ACTION\_DIAL works without any special permissions. The bad news is that it only takes the user to the Dialer – the user still has to take action (pressing the green call button) to actually place the phone call.

An alternative approach is to use ACTION\_CALL instead of ACTION\_DIAL. Calling `startActivity()` on an ACTION\_CALL Intent will immediately place the phone call, without any other UI steps required. However, you need the CALL\_PHONE [permission](#) in order to use ACTION\_CALL.



# Working With SMS

---

SMS and Android combine to make for a frustrating experience.

While Android devices have reasonable SMS capability, much of that is out of the reach of developers following the official SDK. For various reasons — some defensible, others less so — there is no officially-supported way to create an SMS client, receive SMS data messages on specified ports, and so forth. Eventually, perhaps, this situation will be improved.

This chapter starts with the one thing you can do – [send an SMS](#), either directly or by invoking the user’s choice of SMS client. The chapter ends with a discussion of the various [unsanctioned aspects of SMS](#) that you may see other developers using, and why you may not want to follow suit.

## Prerequisites

Understanding this chapter requires that you have read the core chapters, particularly the chapters on [broadcast Intents](#). One of the samples uses [the ContactsContract provider](#), so reading that chapter will help you understand that particular sample.

## Sending Out an SOS, Give or Take a Letter

While much of Android’s SMS capabilities are not in the SDK, sending an SMS is. You have two major choices for doing this:

- Invoke the user’s choice of SMS client application, so they can compose a message, track its progress, and so forth using that tool



- Send the SMS directly yourself, bypassing any existing client

Which of these is best for you depends on what your desired user experience is. If you are composing the message totally within your application, you may want to just send it. However, as we will see, that comes at a price: an extra permission.

### Sending Via the SMS Client

Sending an SMS via the user's choice of SMS client is very similar to the use of ACTION\_SEND described [elsewhere in this book](#). You craft an appropriate Intent, then call startActivity() on that Intent to bring up an SMS client (or allow the user to choose between clients).

The Intent differs a bit from the ACTION\_SEND example:

1. You use ACTION\_SENDTO, rather than ACTION\_SEND
2. Your Uri needs to begin with smsto:, followed by the mobile number you want to send the message to
3. Your text message goes in an sms\_body extra on the Intent

For example, here is a snippet of code from the [SMS/Sender](#) sample project:

```
Intent sms=new Intent(Intent.ACTION_SENDTO,
                    Uri.parse("smsto:"+c.getString(2)));
sms.putExtra("sms_body", msg.getText().toString());
startActivity(sms);
```

Here, our phone number is coming out of the third column of a Cursor, and the text message is coming from an EditText — more on how this works later in this section, when we review the Sender sample more closely.

### Sending SMS Directly

If you wish to bypass the UI and send an SMS directly, you can do so through the SmsManager class, in the android.telephony package. Unlike most Android classes ending in Manager, you obtain an SmsManager via a static getDefault() method on the SmsManager class. You can then call sendTextMessage(), supplying:

1. The phone number to send the text message to

## WORKING WITH SMS

---

2. The “service center” address — leave this null unless you know what you are doing
3. The actual text message
4. A pair of PendingIntent objects to be executed when the SMS has been sent and delivered, respectively

If you are concerned that your message may be too long, use `divideMessage()` on `SmsManager` to take your message and split it into individual pieces. Then, you can use `sendMultipartTextMessage()` to send the entire `ArrayList` of message pieces.

For this to work, your application needs to hold the `SEND_SMS` permission, via a child element of your `<manifest>` element in your `AndroidManifest.xml` file.

For example, here is code from `Sender` that uses `SmsManager` to send the same message that the previous section sent via the user’s choice of SMS client:

```
SmsManager
    .getDefault()
    .sendTextMessage(c.getString(2), null,
                    msg.getText().toString(),
                    null, null);
```

### Inside the Sender Sample

The `Sender` example application is fairly straightforward, given the aforementioned techniques.

The manifest has both the `SEND_SMS` and `READ_CONTACTS` permissions, because we want to allow the user to pick a mobile phone number from their list of contacts, rather than type one in by hand:

```
<?xml version="1.0" encoding="utf-8"?>
<manifest xmlns:android="http://schemas.android.com/apk/res/android"
    package="com.commonware.android.sms.sender"
    android:installLocation="preferExternal"
    android:versionCode="1"
    android:versionName="1.0">

    <uses-permission android:name="android.permission.READ_CONTACTS" />
    <uses-permission android:name="android.permission.SEND_SMS" />

    <uses-sdk
        android:minSdkVersion="7"
        android:targetSdkVersion="11" />

    <supports-screens
```

## WORKING WITH SMS

---

```
    android:largeScreens="true"
    android:normalScreens="true"
    android:smallScreens="false"/>

<application
    android:icon="@drawable/ic_launcher"
    android:label="@string/app_name">
    <activity
        android:name="Sender"
        android:label="@string/app_name">
        <intent-filter>
            <action android:name="android.intent.action.MAIN"/>

            <category android:name="android.intent.category.LAUNCHER"/>
        </intent-filter>
    </activity>
</application>

</manifest>
```

If you noticed the `android:installLocation` attribute in the root element, that is to allow this application to be installed onto external storage, such as an SD card — this will be covered in greater detail [elsewhere in this book](#).

The layout has a Spinner (for a drop-down of available mobile phone numbers), a pair of RadioButton widgets (to indicate which way to send the message), an EditText (for the text message), and a “Send” Button:

```
<?xml version="1.0" encoding="utf-8"?>
<LinearLayout xmlns:android="http://schemas.android.com/apk/res/android"
    android:orientation="vertical"
    android:layout_width="match_parent"
    android:layout_height="match_parent"
>
    <Spinner android:id="@+id/spinner"
        android:layout_width="match_parent"
        android:layout_height="wrap_content"
        android:drawSelectorOnTop="true"
    />
    <RadioGroup android:id="@+id/means"
        android:orientation="horizontal"
        android:layout_width="match_parent"
        android:layout_height="wrap_content"
    >
        <RadioButton android:id="@+id/client"
            android:layout_width="wrap_content"
            android:layout_height="wrap_content"
            android:checked="true"
            android:text="Via Client" />
        <RadioButton android:id="@+id/direct"
            android:layout_width="wrap_content"
```

## WORKING WITH SMS

---

```
        android:layout_height="wrap_content"
        android:text="Direct" />
</RadioGroup>
<EditText
    android:id="@+id/msg"
    android:layout_width="match_parent"
    android:layout_height="0px"
    android:layout_weight="1"
    android:singleLine="false"
    android:gravity="top|left"
/>
<Button
    android:id="@+id/send"
    android:text="Send!"
    android:layout_width="match_parent"
    android:layout_height="wrap_content"
    android:onClick="sendMessage"
/>
</LinearLayout>
```

Sender uses the same technique for obtaining mobile phone numbers from our contacts as is seen in the [chapter on contacts](#). To support Android 1.x and Android 2.x devices, we implement an abstract class and two concrete implementations, one for the old API and one for the new. The abstract class then has a static method to get at an instance suitable for the device the code is running on:

```
package com.commonware.android.sms.sender;

import android.app.Activity;
import android.os.Build;
import android.widget.AdapterView;

abstract class ContactsAdapterBridge {
    abstract AdapterView buildPhonesAdapter(Activity a);

    public static final ContactsAdapterBridge INSTANCE=buildBridge();

    private static ContactsAdapterBridge buildBridge() {
        int sdk=new Integer(Build.VERSION.SDK).intValue();

        if (sdk<5) {
            return(new OldContactsAdapterBridge());
        }

        return(new NewContactsAdapterBridge());
    }
}
```

The Android 2.x edition uses ContactsContract to find just the mobile numbers:

## WORKING WITH SMS

---

```
package com.commonware.android.sms.sender;

import android.app.Activity;
import android.database.Cursor;
import android.provider.ContactsContract.Contacts;
import android.provider.ContactsContract.CommonDataKinds.Phone;
import android.widget.AdapterView;
import android.widget.SimpleCursorAdapter;

class NewContactsAdapterBridge extends ContactsAdapterBridge {
    SpinnerAdapter buildPhonesAdapter(Activity a) {
        String[] PROJECTION=new String[] { Contacts._ID,
                                           Contacts.DISPLAY_NAME,
                                           Phone.NUMBER
                                           };
        String[] ARGS={String.valueOf(Phone.TYPE_MOBILE)};
        Cursor c=a.managedQuery(Phone.CONTENT_URI,
                               PROJECTION, Phone.TYPE+"=?",
                               ARGS, Contacts.DISPLAY_NAME);

        SimpleCursorAdapter adapter=new SimpleCursorAdapter(a,
                                                           android.R.layout.simple_spinner_item,
                                                           c,
                                                           new String[] {
                                                               Contacts.DISPLAY_NAME
                                                           },
                                                           new int[] {
                                                               android.R.id.text1
                                                           });

        adapter.setDropDownViewResource(
            android.R.layout.simple_spinner_dropdown_item);

        return(adapter);
    }
}
```

... while the Android 1.x edition uses the older Contacts provider to find the mobile numbers:

```
package com.commonware.android.sms.sender;

import android.app.Activity;
import android.database.Cursor;
import android.provider.Contacts;
import android.widget.SimpleCursorAdapter;
import android.widget.AdapterView;

@SuppressWarnings("deprecation")
class OldContactsAdapterBridge extends ContactsAdapterBridge {
    SpinnerAdapter buildPhonesAdapter(Activity a) {
        String[] PROJECTION=new String[] { Contacts.Phones._ID,
                                           Contacts.Phones.NAME,
                                           Contacts.Phones.NUMBER
                                           };
        String[] ARGS={String.valueOf(Contacts.Phones.TYPE_MOBILE)};
        Cursor c=a.managedQuery(Contacts.Phones.CONTENT_URI,
                               PROJECTION, Contacts.Phones.TYPE+"=?",
                               ARGS, Contacts.Phones.NAME);

        SimpleCursorAdapter adapter=new SimpleCursorAdapter(a,
                                                           android.R.layout.simple_spinner_item,
                                                           c,
                                                           new String[] {
                                                               Contacts.Phones.NAME
                                                           },
                                                           new int[] {
                                                               android.R.id.text1
                                                           });

        adapter.setDropDownViewResource(
            android.R.layout.simple_spinner_dropdown_item);

        return(adapter);
    }
}
```

## WORKING WITH SMS

---

```
                Contacts.Phones.NUMBER
            };
String[] ARGS={String.valueOf(Contacts.Phones.TYPE_MOBILE)};
Cursor c=a.managedQuery(Contacts.Phones.CONTENT_URI,
    PROJECTION,
    Contacts.Phones.TYPE+"=?", ARGS,
    Contacts.Phones.NAME);

SimpleCursorAdapter adapter=new SimpleCursorAdapter(a,
    android.R.layout.simple_spinner_item,
    c,
    new String[] {
        Contacts.Phones.NAME
    },
    new int[] {
        android.R.id.text1
    });

adapter.setDropDownViewResource(
    android.R.layout.simple_spinner_dropdown_item);

return(adapter);
}
}
```

For more details on how those providers work, please see the [chapter on contacts](#).

The activity then loads up the Spinner with the appropriate list of contacts. When the user taps the Send button, the `sendMessage()` method is invoked (courtesy of the `android:onClick` attribute in the layout). That method looks at the radio buttons, sees which one is selected, and routes the text message accordingly:

```
package com.commonware.android.sms.sender;

import android.app.Activity;
import android.content.Intent;
import android.database.Cursor;
import android.net.Uri;
import android.os.Bundle;
import android.telephony.SmsManager;
import android.view.View;
import android.widget.EditText;
import android.widget.RadioGroup;
import android.widget.Spinner;

public class Sender extends Activity {
    Spinner contacts=null;
    RadioGroup means=null;
    EditText msg=null;

    @Override
    public void onCreate(Bundle savedInstanceState) {
```

## WORKING WITH SMS

---

```
super.onCreate(savedInstanceState);
setContentView(R.layout.main);

contacts=(Spinner)findViewById(R.id.spinner);

contacts.setAdapter(new ContactsAdapterBridge
    .INSTANCE
    .buildPhonesAdapter(this));

means=(RadioGroup)findViewById(R.id.means);
msg=(EditText)findViewById(R.id.msg);
}

public void sendMessage(View v) {
    Cursor c=(Cursor)contacts.getSelectedItem();

    if (means.getCheckedRadioButtonId()==R.id.client) {
        Intent sms=new Intent(Intent.ACTION_SENDTO,
            Uri.parse("smsto:"+c.getString(2)));

        sms.putExtra("sms_body", msg.getText().toString());

        startActivity(sms);
    }
    else {
        SmsManager
            .getDefault()
            .sendTextMessage(c.getString(2), null,
                msg.getText().toString(),
                null, null);
    }
}
}
```

### SMS Sending Limitations

Apps running on Android 1.x and 2.x devices are limited to sending 100 SMS messages an hour, before the user starts getting prompted with each SMS message request to confirm that they do indeed wish to send it.

Apps running on Android 4.x devices, the limits are now 30 SMS messages in 30 minutes, [according to some source code analysis by Al Sutton](#).

### You Can't Get There From Here

The Android SDK is vast. It, however, does not cover everything. Many Android capabilities are not part of the SDK, though they can be accessed via indirect means. Doing so is dangerous, for two reasons:

## WORKING WITH SMS

---

- Things not in the SDK and not part of the [Compatibility Definition Document](#) might well be replaced by device manufacturers. For example, even though the Android open source project has a stock SMS client, device manufacturers could replace it. Your application, therefore, may work on some devices but not others.
- Things not in the SDK are subject to modification by the core Android team, and if you fail to react to those modifications (or cannot react, as the case may be), your application will fail on future versions of Android.

Developers are [strongly encouraged](#) to stick within the limits of the SDK. That being said, let us take a look at a pair of SMS capabilities that are beyond the SDK, still get used by developers, and what risks you will encounter by mirroring their techniques.

### Receiving SMS

It is possible for an application to receive an incoming SMS message... if you are willing to listen on the undocumented `android.provider.Telephony.SMS_RECEIVED` broadcast Intent. That is sent by Android whenever an SMS arrives, and it is up to an application to implement a `BroadcastReceiver` to respond to that Intent and do something with the message. The Android open source project has such an application — Messaging — and device manufacturers can replace it with something else.

The `BroadcastReceiver` can then turn around and use the `SmsMessage` class, in the `android.telephony` package, to get at the message itself, through the following undocumented recipe:

1. Given the received Intent (`intent`), call `intent.getExtras().get("pdus")` to get an `Object[]` representing the raw portions of the message
2. For each of those “pdus” objects, call `SmsMessage.createFromPdu()` to convert the `Object` into an `SmsMessage` — though to make this work, you need to cast the `Object` to a `byte[]` as part of passing it to the `createFromPdu()` static method

The resulting `SmsMessage` object gets you access to the text of the message, the sending phone number, etc.

The `SMS_RECEIVED` broadcast Intent is broadcast a bit differently than most others in Android. It is an “ordered broadcast”, meaning the Intent will be delivered to one `BroadcastReceiver` at a time. This has two impacts of note:



## WORKING WITH SMS

---

- In your receiver's `<intent-filter>` element, you can have an `android:priority` attribute. Higher priority values get access to the broadcast Intent earlier than will lower priority values. The standard Messaging application has the default priority (undocumented, appears to be 0 or 1), so you can arrange to get access to the SMS before the application does.
- Your `BroadcastReceiver` can call `abortBroadcast()` on itself to prevent the Intent from being broadcast to other receivers of lower priority. In effect, this causes your receiver to consume the SMS – the Messaging application will not receive it.

However, just because the Messaging application has the default priority does not mean all SMS clients will, and so you cannot reliably intercept SMS messages this way. That, plus the undocumented nature of all of this, means that applications you write to receive SMS messages are likely to be fragile in production, breaking on various devices due to device manufacturer-installed apps, third-party apps, or changes to Android itself in the future.

### Working With Existing Messages

When perusing the Internet, you will find various blog posts and such referring to the SMS inbox `ContentProvider`, represented by the `content://sms/inbox` `Uri`.

This `ContentProvider` is undocumented and is not part of the Android SDK, because it is not part of the Android OS.

Rather, this `ContentProvider` is used by the aforementioned Messaging application, for storing saved SMS messages. And, as noted, this application may or may not exist on any given Android device. If a device manufacturer replaces Messaging with their own application, there may be nothing on that device that responds to that `Uri`, or the schemas may be totally different. Plus, Android may well change or even remove this `ContentProvider` in future editions of Android.

For all those reasons, developers should not be relying upon this `ContentProvider`.

# Using the Camera

---

Most Android devices will have a camera, since they are fairly commonplace on mobile devices these days. You, as an Android developer, can take advantage of the camera, for everything from snapping tourist photos to scanning barcodes. For simple operations, the APIs needed to use the camera are fairly straight-forward, requiring a bit of boilerplate code plus your own unique application logic.

## Prerequisites

Understanding this chapter requires that you have read the core chapters, particularly the material on [implicit Intents](#).

## Letting the Camera App Do It

The easiest way to take a picture is to not take the picture yourself, but let somebody else do it. The most common implementation of this approach is to use an `ACTION_IMAGE_CAPTURE` Intent to bring up the user's default camera application, and let it take a picture on your behalf.

To see this in use, take a look at the [Camera/Content](#) sample project. This trivial app will use system-supplied activities to take a picture, then view the result, without actually implementing any of its own UI.

## The Implementation

Of course, we still need an activity, so our code can be launched by the user. We just set it up with `Theme.NoDisplay`, so no UI will be created for it:

## USING THE CAMERA

---

```
<activity
  android:name=".CameraContentDemoActivity"
  android:label="@string/app_name"
  android:theme="@android:style/Theme.NoDisplay">
  <intent-filter>
    <action android:name="android.intent.action.MAIN"/>

    <category android:name="android.intent.category.LAUNCHER"/>
  </intent-filter>
</activity>
```

The activity itself — `CameraContentDemoActivity` — consists solely of `onCreate()` and `onActivityResult()` methods:

```
@Override
public void onCreate(Bundle savedInstanceState) {
    super.onCreate(savedInstanceState);

    Intent i=new Intent(MediaStore.ACTION_IMAGE_CAPTURE);
    File dir=
Environment.getExternalStoragePublicDirectory(Environment.DIRECTORY_DCIM);

    output=new File(dir, "CameraContentDemo.jpeg");
    i.putExtra(MediaStore.EXTRA_OUTPUT, Uri.fromFile(output));

    startActivityForResult(i, CONTENT_REQUEST);
}

@Override
protected void onActivityResult(int requestCode, int resultCode,
                                Intent data) {
    if (requestCode == CONTENT_REQUEST) {
        if (resultCode == RESULT_OK) {
            Intent i=new Intent(Intent.ACTION_VIEW);

            i.setDataAndType(Uri.fromFile(output), "image/jpeg");
            startActivity(i);
            finish();
        }
    }
}
}
```

In `onCreate()`, we create our `ACTION_IMAGE_CAPTURE` Intent. We add an extra, keyed as `MediaStore.EXTRA_OUTPUT`, indicating where we want the app to save the resulting picture. In our case, we store that in a `CameraContentDemo.jpeg` file in the default external storage directory for photos (identified by `Environment.DIRECTORY_DCIM`). The documentation for `ACTION_IMAGE_CAPTURE`

indicates that this needs to be in the form of a `Uri` object, which is why we use `Uri.fromFile()` to convert our string path into the `Uri`.

At that point, we call `startActivityForResult()` to bring up the user's chosen camera app to take our picture. We next get control in `onActivityResult()`. There, we create an `ACTION_VIEW` Intent, pointing at our output file, indicating the MIME type is `image/jpeg`, and start up an activity for that. This should bring up the Gallery or another app capable of displaying the photo on the screen.

### The Caveats

There are several downsides to this approach.

First, you have no control over the camera app itself. You do not even really know what app it is. You cannot dictate certain features that you would like (e.g., resolution, color effects). You simply blindly ask for a photo and get the result.

Also, since you do not know what the camera app is or behaves like, you cannot document that portion of your application's flow very well. You can say things like "at this point, you can take a picture using your chosen camera app", but that is about as specific as you can get.

Finally, some camera apps misbehave, returning odd results, such as a thumbnail-sized image rather than a max-resolution image. There is little you can do about this.

So, while this approach is easy, it may pose some quality-control issues.

### Scanning with ZXing

If your objective is to scan a barcode, it is *much* simpler for you to integrate Barcode Scanner into your app than to roll it yourself.

[Barcode Scanner](#) – one of the most popular Android apps of all time — can scan a wide range of 1D and 2D barcode types. They offer an integration library that you can add to your app to initiate a scan and get the results. The library will even lead to the user to the Play Store to install Barcode Scanner if they do not already have the app.

## USING THE CAMERA

---

One limitation is that while the ZXing team (the authors and maintainers of Barcode Scanner) make the integration library available, they only do so in [source form](#), requiring you to check out a bunch of source code and run a command-line build to get a JAR. Or, you can [download a JAR](#) that is used in the sample project for this section, if you prefer.

That sample project — [Camera/ZXing](#) – has a UI dominated by a “Scan!” button. Clicking the button invokes a `doScan()` method in our sample activity:

```
public void doScan(View v) {
    (new IntentIntegrator(this)).initiateScan();
}
```

This passes control to Barcode Scanner by means of the integration JAR and the `IntentIntegrator` class. `initiateScan()` will validate that Barcode Scanner is installed, then will start up the camera and scan for a barcode.

Once Barcode Scanner detects a barcode and decodes it, the activity invoked by `initiateScan()` finishes, and control returns to you in `onActivityResult()` (as the Barcode Scanner scanning activity was invoked via `startActivityForResult()`). There, you can once again use `IntentIntegrator` to find out details of the scan, notably the type of barcode and the encoded contents:

```
public void onActivityResult(int request, int result, Intent i) {
    IntentResult scan=IntentIntegrator.parseActivityResult(request,
        result,
        i);

    if (scan!=null) {
        format.setText(scan.getFormatName());
        contents.setText(scan.getContents());
    }
}
```

Some notes:

- Barcode Scanner’s scanning activity only works in landscape
- Even though you are not using the camera directly yourself, you should consider including the `<uses-feature>` element declaring that you need a camera, if your app cannot function without barcodes
- If you wish to add Barcode Scanner logic directly to your app, and avoid the dependency on the third-party APK, that is possible, but the process for doing it is not well documented

## Directly Working with the Camera

There is a `Camera` class in `android.hardware` that gives you the ability to work directly with the camera, to take pictures, process the stream of preview images, and the like. Unfortunately, getting something reliable using the `Camera` class is difficult, and frankly baffling (e.g., the aspect ratio of how you depict the preview on the screen dictates the aspect ratio of the resulting JPEG file). While previous editions of the CommonsWare material used to cover directly using the `Camera` class, that material has been removed, as the author is no longer confident in explaining it accurately to readers.

You will find working — albeit unexplained — sample projects in [Camera/Preview](#) and [Camera/Picture](#). Some of that code may eventually wind up in a reusable component that itself might be covered in a future edition of this book.

## Being Specific About Features

If your app needs a camera — whether for direct use via the `Camera` class or for indirect use via something like `ACTION_IMAGE_CAPTURE` — you should include a `<uses-feature>` element in the manifest indicating your requirements. However, you need to be fairly specific about your requirements here.

For example, the Nexus 7 has a camera... but only a front-facing camera. This facilitates apps like video chat. However, the `android.hardware.camera` implies that you need a high-resolution rear-facing camera, [even though this is undocumented](#). Hence, to work with the Nexus 7's camera, you need to:

- Require the `CAMERA` permission (if you are using the `Camera` directly)
- Not require the `android.hardware.camera` feature (`android:required="false"`)
- Optionally require the `android.hardware.camera.front` feature (if your app definitely needs a front-facing camera)

At runtime, you would use `hasSystemFeature()` on `PackageManager`, or interrogate the `Camera` class for available cameras, to determine what you have access to.



NFC, courtesy of high-profile boosters like Google Wallet, is poised to be a significant new capability in Android devices. While at the time of this writing, only a handful of Android devices have NFC built in, other handsets are slated to be NFC-capable in the coming months. Google is hoping that developers will write NFC-aware applications to help further drive adoption of this technology by device manufacturers.

This, of course, raises the question: what is NFC? Besides being where the Green Bay Packers play, that is?

(For those of you from outside of the United States, that was an American football joke. We now return you to your regularly-scheduled chapter.)

## Prerequisites

Understanding this chapter requires that you have read the core chapters, particularly the chapters on [broadcast Intents](#) and [services](#).

## What Is NFC?

NFC stands for Near-Field Communications. It is a wireless standard for data exchange, aimed at very short range transmissions — on the order of a couple of centimeters. NFC is in wide use today, for everything from credit cards to passports. Typically, the NFC data exchange is for simple data — contact information, URLs, and the like.



## NFC

---

In particular, NFC tends to be widely used where one side of the communications channel is “passive”, or unpowered. The other side (the “initiator”) broadcasts a signal, which the passive side converts into power enough to send back its response. As such, NFC “tags” containing such passive targets can be made fairly small and can be embedded in a wide range of containers, from stickers to cards to hats.

The objective is “low friction” interaction — no pairing like with Bluetooth, no IP address shenanigans as with WiFi. The user just taps and goes.

### ... Compared to RFID?

NFC is often confused with or compared to RFID. It is simplest to think of RFID as being an umbrella term, under which NFC falls. Not every RFID technology is NFC, but many things that you hear of being “RFID” may actually be NFC-compliant devices or tags.

### ... Compared to QR Codes?

In many places, NFC will be used in ways you might consider using QR codes. For example, a restaurant could use either technology, or both, on a sign to lead patrons to the restaurant’s [Yelp](#) page, as a way of soliciting reviews. Somebody with a capable device could either tap the NFC tag on the sign to bring up Yelp or take a picture of the QR code and use that to bring up Yelp.

NFC’s primary advantage over QR codes is that it requires no user intervention beyond physically moving their device in close proximity to the tag. QR codes, on the other hand, require the user to launch a barcode scanning application, center the barcode in the viewfinder, and then get the results. The net effect is that NFC will be faster.

QR’s advantages include:

1. No need for any special hardware to generate the code, as opposed to needing a tag and something to write information into the tag for NFC
2. The ability to display QR codes in distant locations (e.g., via Web sites), whereas NFC requires physical proximity

### To NDEF, Or Not to NDEF

RFID is a concept, not a standard. As such, different vendors created their own ways of structuring data on these tags or chips, making one vendor's tags incompatible with another vendor's readers or writers. While various standards bodies, like ISO, have gotten involved, it's still a bit of a rat's nest of conflicting formats and approaches.

The NFC offshoot of RFID has had somewhat greater success in establishing standards. NFC itself is an ISO and ECMA standard, covering things like transport protocols and transfer speeds. And a consortium called the NFC Forum created NDEF — the NFC Data Exchange Format — for specifying the content of tags.

However, not all NFC tags necessarily support NDEF. NDEF is much newer than NFC, and so lots of NFC tags are out in the wild that were distributed before NDEF even existed.

You can roughly divide NFC tags into three buckets:

- Those that support NDEF “out of the box”
- Those that can be “formatted” as NDEF
- Those that use other content schemes

Android has some support for non-NDEF tags, such as the MIFARE Classic. However, the hope and expectation going forward is that NFC tags will coalesce around NDEF.

NDEF, as it turns out, maps neatly to Android's Intent system, as you will see as we proceed through this chapter.

### NDEF Modalities

Most developers interested in NFC will be interested in reading NFC tags and retrieving the NDEF data off of them. In Android, tapping an NDEF tag with an NFC-capable device will trigger an activity to be started, based on a certain `IntentFilter`.

Some developers will be interested in writing to NFC tags, putting URLs, vCards, or other information on them. This may or may not be possible for any given tag.

And while the “traditional” thinking around NFC has been that one side of the communication is a passive tag, Android will help promote the “peer-to-peer” approach — having two Android devices exchange data via NFC and NDEF. Basically, putting the two devices back-to-back will cause each to detect the other device’s “tag”, and each can read and write to the other via this means. This is referred to as “Android Beam” and will be discussed [later in this chapter](#).

Of course, all of these are only available on hardware. At the present time, there is no emulator for NFC, nor any means of accessing a USB NFC reader or writer from the emulator.

## NDEF Structure and Android’s Translation

NDEF is made up of messages, themselves made up of a series of records. From Android’s standpoint, each tag consists of one such message.

Each record consists of a binary (byte[>]) payload plus metadata to describe the nature of the payload. The metadata primarily consists of a type and a subtype. There are quite a few combinations of these, but the big three for new Android NFC uses are:

- A type of `TNF_WELL_KNOWN` and a subtype of `RTD_TEXT`, indicating that the payload is simply plain text
- A type of `TNF_WELL_KNOWN` and a subtype of `RTD_URI`, indicating that the payload is a URI, such as a URL to a Web page
- A type of `TNF_MIME_MEDIA`, where the subtype is a standard MIME type, indicating that the payload is of that MIME type

When Android scans an NDEF tag, it will use this information to construct a suitable Intent to use with `startActivity()`. The action will be `android.nfc.action.NDEF_DISCOVERED`, to distinguish the scanned-tag case from, say, something simply asking to view some content. The MIME type in the Intent will be `text/plain` for the first scenario above or the supplied MIME type for the third scenario above. The data (`Uri`) in the Intent will be the supplied URI for the second scenario above. Once constructed, Android will invoke `startActivity()` on that Intent, bringing up an activity or an activity chooser, as appropriate.

NFC-capable Android devices have a Tags application pre-installed that will handle any NFC tag not handled by some other app. So, for example, an NDEF tag with an

HTTP URL will fire up the Tags application, which in turn will allow the user to open up a Web browser on that URL.

## The Reality of NDEF

The enthusiasm that some have with regards to Android and NFC technology needs to be tempered by the reality of NDEF, NFC tags in general, and Android's support for NFC. It is easy to imagine all sorts of possibilities that may or may not be practical when current limitations are reached.

### Some Tags are Read-Only

Some tags come “from the factory” read-only. Either you arrange for the distributor to write data onto them (e.g., blast a certain URL onto a bunch of NFC stickers to paste onto signs), or they come with some other pre-established data. Touchatag, for example, distributes NFC tags that have Touchatag URLs on them — they then help you set up redirects from their supplied URL to ones you supply.

While these tags will be of interest to consumers and businesses, they are unlikely to be of interest to Android developers, since their use cases are already established and typically do not need custom Android application support. Android developers seeking customizable tags will want ones that are read-write, or at least write-once.

### Some Tags Can't Be Read-Only

Conversely, some tags lack any sort of read-only flag. An ideal tag for developers is one that is write-once: putting an NDEF message on the tag and flagging it read-only in one operation. Some tags do not support this, or making the tag read-only at any later point. The MIFARE Classic 1K tag is an example — while technically it can be made read-only, it requires a key known only to the tag manufacturer.

### Some Tags Need to be Formatted

The MIFARE Classic 1K NFC tag is NDEF-capable, but must be “formatted” first, supplying the initial NDEF message contents. You have the option of formatting it read-write or read-only (turning the Classic 1K a write-once tag).

This is not a problem — in fact, the write-once option may be compelling. However, it is something to keep in mind.

Also, note that the MIFARE Classic 1K, while it can be formatted as NDEF, uses a proprietary protocol “under the covers”. Not all Android devices will support the Classic 1K, as the device manufacturers elect not to pay the licensing fee. Where possible, try to stick to tags that are natively NDEF-compliant (so-called “NFC Forum Tag Types 1–4”).

### Tags Have Limited Storage

The “1K” in the name “MIFARE Classic 1K” refers to the amount of storage on the tag: 1 kilobyte of information.

And that’s far larger than other tags, such as the MIFARE Ultralight C, some of which have ~64 bytes of storage.

Clearly, you will not be writing an MP3 file or JPEG photo to these tags. Rather, the tags will tend to either be a “launcher” into something with richer communications (e.g., URL to a Web site) or will use the sorts of data you may be used to from QR codes, such as a vCard or iCalendar for contact and event data, respectively.

### NDEF Data Structures Are Documented Elsewhere

The Android developer documentation is focused on the [Android classes](#) related to NFC and on [the Intent mechanism used for scanned tags](#). It does not focus on the actual structure of the payloads.

For TNF\_MIME\_MEDIA and RTD\_TEXT, the payload is whatever you want. For RTD\_URI, however, the byte array has a bit more structure to it, as the NDEF specification calls for a single byte to represent the URI prefix (e.g., http://www. versus http:// versus https://www.). The objective, presumably, is to support incrementally longer URLs on tags with minuscule storage. Hence, you will need to convert your URLs into this sort of byte array if you are writing them out to a tag.

Generally speaking, the rules surrounding the structure of NDEF messages and records is found at the [NFC Forum site](#).

### Tag and Device Compatibility

Different devices will have different NFC chipsets. Not all NFC chipsets can read and write all tags. The expectation is that NDEF-formatted tags will work on all devices,

but if you wander away from that, things get dicier. For example, NXP's Mifare Classic tag can only be read and written by NXP's NFC chip.

## Sources of Tags

NFC tags are not the sort of thing you will find on your grocer's shelves. In fact, few, if any, mainstream firms sell them today.

Here are some online sites from which you can order rewritable NFC tags, listed here in alphabetical order:

1. [Buy NFC Stickers](#)
2. [Buy NFC Tags](#)
3. [Smartcard Focus](#)
4. [tagstand](#)

Note that not all may ship to your locale.

## Writing to a Tag

So, let's see what it takes to write an NDEF message to a tag, formatting it if needed. The code samples shown in this chapter are from the [NFC/URLTagger](#) sample application. This application will set up an activity to respond to ACTION\_SEND activity Intents, with an eye towards receiving a URL from a browser, then waiting for a tag and writing the URL to that tag. The idea is that this sort of application could be used by non-technical people to populate tags containing URLs to their company's Web site, etc.

## Getting a URL

First, we need to get a URL from the browser. As we saw in the chapter on integration, the standard Android browser uses ACTION\_SEND of text/plain contents when the user chooses the "Share Page" menu. So, we have one activity, URLTagger, that will respond to such an Intent:

```
<activity
  android:name="URLTagger"
  android:label="@string/app_name">
  <intent-filter android:label="@string/app_name">
    <action android:name="android.intent.action.SEND"/>
  </intent-filter>
</activity>
```

## NFC

---

```
<data android:mimeType="text/plain"/>

  <category android:name="android.intent.category.DEFAULT"/>
</intent-filter>
</activity>
```

Of course, lots of other applications support ACTION\_SEND of text/plain contents that are not URLs. A production-grade version of this application would want to validate the EXTRA\_TEXT Intent extra to confirm that, indeed, this is a URL, before putting in an NDEF message claiming that it is a URL.

### Detecting a Tag

When the user shares a URL with our application, our activity is launched. At that point, we need to go into “detect a tag” mode – the user should then tap their device to a tag, so we can write out the URL.

First, in onCreate(), we get access to the NfcAdapter, which is our gateway to much of the NFC functionality in Android:

```
@Override
public void onCreate(Bundle savedInstanceState) {
    super.onCreate(savedInstanceState);
    setContentView(R.layout.main);

    nfc=NfcAdapter.getDefaultAdapter(this);
}
```

We use a boolean data member — inWriteMode — to keep track of whether or not we are set up to write to a tag. Initially, of course, that is set to be false. Hence, when we are first launched, by the time we get to onResume(), we can go ahead and register our interest in future tags:

```
@Override
public void onResume() {
    super.onResume();

    if (!inWriteMode) {
        IntentFilter discovery=new IntentFilter(NfcAdapter.ACTION_TAG_DISCOVERED);
        IntentFilter[] tagFilters=new IntentFilter[] { discovery };
        Intent i=new Intent(this, getClass())
            .addFlags(Intent.FLAG_ACTIVITY_SINGLE_TOP|
                Intent.FLAG_ACTIVITY_CLEAR_TOP);
        PendingIntent pi=PendingIntent.getActivity(this, 0, i, 0);

        inWriteMode=true;
        nfc.enableForegroundDispatch(this, pi, tagFilters, null);
    }
}
```

## NFC

---

```
}  
}
```

When an NDEF-capable tag is within signal range of the device, Android will invoke `startActivity()` for the `NfcAdapter.ACTION_TAG_DISCOVERED` Intent action.

However, it can do this in one of two ways:

- Normally, it will use a chooser (via `Intent.createChooser()`) to allow the user to pick from any activities that claim to support this action.
- The foreground application can request via `enableForegroundDispatch()` for it to handle all tag events while it is in the foreground, superseding the normal `startActivity()` flow. In this case, while Android still will invoke an activity, it will be our activity, not any other one.

We want the second approach right now, so the next tag brought in range is the one we will try writing to.

To do that, we need to create an array of `IntentFilter` objects, identifying the NFC-related actions that we want to capture in the foreground. In this case, we only care about `ACTION_TAG_DISCOVERED` – if we were supporting non-NDEF NFC tags, we might also need to watch for `ACTION_TECH_DISCOVERED`.

We also need a `PendingIntent` identifying the activity that should be invoked when such a tag is encountered while we are in the foreground. Typically, this will be the current activity. By adding `FLAG_ACTIVITY_SINGLE_TOP` and `FLAG_ACTIVITY_CLEAR_TOP` to the Intent as flags, we ensure that our current specific instance of the activity will be given control again via `onNewIntent()`.

Armed with those two values, we can call `enableForegroundDispatch()` on the `NfcAdapter` to register our request to process tags via the current activity instance.

In `onPause()`, if the activity is finishing, we call `disableForegroundDispatch()` to undo the work done in `onResume()`:

```
@Override  
public void onPause() {  
    if (isFinishing()) {  
        nfc.disableForegroundDispatch(this);  
        inWriteMode=false;  
    }  
  
    super.onPause();  
}
```



## NFC

---

We have to see if we are finishing, because even though our activity never leaves the screen, Android still calls `onPause()` and `onResume()` as part of delivering the Intent to `onNewIntent()`. Our approach, though, has flaws — if the user presses HOME, for example, we never disable the NFC dispatch logic. A production-grade application would need to handle this better.

For any of this code to work, we need to hold the NFC permission via an appropriate line in the manifest:

```
<uses-permission android:name="android.permission.NFC"/>
```

Also note that if you have several activities that the user can reach while you are trying to also capture NFC tag events, you will need to call `enableForegroundDispatch()` in each activity — it's a per-activity request, not a per-application request.

### Reacting to a Tag

Once the user brings a tag in range, `onNewIntent()` will be invoked with the `ACTION_TAG_DISCOVERED` Intent action:

```
@Override
protected void onNewIntent(Intent intent) {
    if (inWriteMode &&
        NfcAdapter.ACTION_TAG_DISCOVERED.equals(intent.getAction())) {
        Tag tag=intent.getParcelableExtra(NfcAdapter.EXTRA_TAG);
        byte[] url=buildUrlBytes(getIntent().getStringExtra(Intent.EXTRA_TEXT));
        NdefRecord record=new NdefRecord(NdefRecord.TNF_WELL_KNOWN,
            NdefRecord.RTD_URI,
            new byte[] {}, url);
        NdefMessage msg=new NdefMessage(new NdefRecord[] {record});

        new WriteTask(this, msg, tag).execute();
    }
}
```

If we are in write mode and the delivered Intent is indeed an `ACTION_TAG_DISCOVERED` one, we can get at the Tag object associated with the user's NFC tag via the `NfcAdapter.EXTRA_TAG` Parcelable extra on the Intent.

Writing an NDEF message to the tag, therefore, is a matter of crafting the message and actually writing it. An NDEF message consists of one or more records (though, typically, only one record is used), with each record wrapping around a byte array of payload data.

### Getting the Shared URL

We did not do anything to get the URL out of the Intent back in `onCreate()`, when our activity was first started up. Now, of course, we need that URL. You might think it is too late to get it, since our activity was effectively started again due to the tag and `onNewIntent()`.

However, `getIntent()` on an Activity always returns the Intent used to create the activity in the first place. The `getIntent()` value is not replaced when `onNewIntent()` is called.

Hence, as part of the `buildUrlBytes()` method to create the binary payload, we can go and call `getIntent().getStringExtra(Intent.EXTRA_TEXT)` to retrieve the URL.

### Creating the Byte Array

Given the URL, we need to convert it into a byte array suitable for use in a `TNF_WELL_KNOWN`, `RTD_URI NDEF` record. Ordinarily, you would just call `toByteArray()` on the `String` and be done with it. However, the byte array we need uses a single byte to indicate the URL prefix, with the rest of the byte array for the characters after this prefix.

This is efficient. This is understandable. This is annoying.

First, we need the roster of prefixes, defined in `URLTagger` as a static data member cunningly named `PREFIXES`:

```
static private final String[] PREFIXES={"http://www.", "https://www.",
    "http://", "https://",
    "tel:", "mailto:",
    "ftp://anonymous:anonymous@",
    "ftp://ftp.", "ftps://",
    "sftp://", "smb://",
    "nfs://", "ftp://",
    "dav://", "news:",
    "telnet://", "imap:",
    "rtsp://", "urn:",
    "pop:", "sip:", "sips:",
    "tftp:", "btsp://",
    "bt12cap://", "btgoep://",
    "tcpobex://",
    "irdaobex://",
    "file://", "urn:epc:id:",
    "urn:epc:tag:",
    "urn:epc:pat:"}
```

```
"urn:epc:raw:",  
"urn:epc:", "urn:nfc:"};
```

Then, in `buildUrlBytes()`, we need to find the prefix (if any) and use it:

```
private byte[] buildUrlBytes(String url) {  
    byte prefixByte=0;  
    String subset=url;  
    int bestPrefixLength=0;  
  
    for (int i=0;i<PREFIXES.length;i++) {  
        String prefix = PREFIXES[i];  
  
        if (url.startsWith(prefix) && prefix.length() > bestPrefixLength) {  
            prefixByte=(byte)(i+1);  
            bestPrefixLength=prefix.length();  
            subset=url.substring(bestPrefixLength);  
        }  
    }  
  
    final byte[] subsetBytes = subset.getBytes();  
    final byte[] result = new byte[subsetBytes.length+1];  
  
    result[0]=prefixByte;  
    System.arraycopy(subsetBytes, 0, result, 1, subsetBytes.length);  
  
    return(result);  
}
```

We iterate over the `PREFIXES` array and find a match, if any, and the best possible match if there is more than one. If there is a match, we record the NDEF value for the first byte (our `PREFIXES` index plus one) and create a subset string containing the characters after the prefix. If there is no matching prefix, the prefix byte is 0 and we will include the full URL.

Given that, we construct a byte array containing our prefix byte in the first slot, and the rest taken up by the byte array of the subset of our URL.

### Creating the NDEF Record and Message

Given the result of `buildUrlBytes()`, our `onNewIntent()` implementation creates a `TNF_WELL_KNOWN`, `RTD_URI` `NdefRecord` object, and pours that into an `NdefMessage` object.

The third parameter to the `NdefRecord` constructor is a byte array representing the optional “ID” of this record, which is not necessary here.

Finally, we delegate the actual writing to a WriteTask subclass of AsyncTask, as writing the NdefMessage to the Tag is... interesting.

### Writing to a Tag

Here is the aforementioned WriteTask static inner class:

```
static class WriteTask extends AsyncTask<Void, Void, Void> {
    Activity host=null;
    NdefMessage msg=null;
    Tag tag=null;
    String text=null;

    WriteTask(Activity host, NdefMessage msg, Tag tag) {
        this.host=host;
        this.msg=msg;
        this.tag=tag;
    }

    @Override
    protected Void doInBackground(Void... arg0) {
        int size=msg.toByteArray().length;

        try {
            Ndef ndef=Ndef.get(tag);

            if (ndef==null) {
                NdefFormatable formatable=NdefFormatable.get(tag);

                if (formatable!=null) {
                    try {
                        formatable.connect();

                        try {
                            formatable.format(msg);
                        }
                        catch (Exception e) {
                            text="Tag refused to format";
                        }
                    }
                    catch (Exception e) {
                        text="Tag refused to connect";
                    }
                    finally {
                        formatable.close();
                    }
                }
            }
            else {
                text="Tag does not support NDEF";
            }
        }
        else {
```

```
ndef.connect();

try {
    if (!ndef.isWritable()) {
        text="Tag is read-only";
    }
    else if (ndef.getMaxSize()<size) {
        text="Message is too big for tag";
    }
    else {
        ndef.writeNdefMessage(msg);
    }
}
catch (Exception e) {
    text="Tag refused to connect";
}
finally {
    ndef.close();
}
}

catch (Exception e) {
    Log.e("URLTagger", "Exception when writing tag", e);
    text="General exception: "+e.getMessage();
}

return(null);
}

@Override
protected void onPostExecute(Void unused) {
    if (text!=null) {
        Toast.makeText(host, text, Toast.LENGTH_SHORT).show();
    }

    host.finish();
}
}
```

In `doInBackground()`, after making note of how big the message is in bytes, we first try to get the Ndef aspect of the Tag object, by calling the static `get()` method on the Ndef class. If the tag is an NDEF tag, this should return an Ndef instance. If it does not, we try to get an NdefFormatable aspect by calling `get()` on the NdefFormatable class. If the tag is not NDEF now but can be formatted as NDEF, this should give us an NdefFormatable object. If both aspect attempts fail, we bail out, displaying a Toast to let the user know that while the tag they used is NFC, it is not NDEF-compliant.

If the tag turned out to be NdefFormatable, to put the NdefMessage on it, we first `connect()` to the tag, then `format()` it, supplying the message. NdefFormatable also

supports `formatReadOnly()` for tags that support that mode — this will write the message on the tag, then block it from further updates. When we are done, we `close()` the connection.

If the tag turned out to be Ndef already, we `connect()` to it, then see if it is writable and has enough room. If it meets both of those criteria, we can emit the message via `writeNdefMessage()`, which overwrites the NDEF message that had already existed on the tag (if any). If the tag supported it, a call to `makeReadOnly()` would block further updates to the tag. Again, when we are done, we `close()` the connection.

All of the actual NFC I/O is performed in `doInBackground()`, because this I/O may take some time, and we do not want to block the main application thread while doing it.

## Responding to a Tag

Writing to a tag is a bit complicated. Responding to an NDEF message on a tag is significantly easier.

If the foreground activity is not consuming NFC events — as `URLTagger` does in write mode — then Android will use normal Intent resolution with `startActivity()` to handle the tag. To respond to the tag, all you need to do is have an activity set up to watch for an `android.nfc.action.NDEF_DISCOVERED` Intent. To get control ahead of the built-in Tags application, also have a `<data>` element that describes the sort of content or URL you are expecting to find on the tag.

For example, suppose you used the Android browser to visit [some page on the CommonsWare Web site](#), and you wrote that to a tag using `URLTagger`. The `URLTagger` application has another activity, `URLHandler`, that will respond when you tap the newly-written tag from the home screen or anywhere else. It accomplishes this via a suitable `<intent-filter>`:

```
<activity
  android:name="URLHandler"
  android:label="@string/app_name">
  <intent-filter android:label="@string/app_name">
    <action android:name="android.nfc.action.NDEF_DISCOVERED"/>

    <data
      android:host="commonsware.com"
      android:scheme="http"/>

    <category android:name="android.intent.category.DEFAULT"/>
  </intent-filter>
</activity>
```

```
</intent-filter>  
</activity>
```

The `URLHandler` activity can then use `getIntent()` to retrieve the key pieces of data from the tag itself, if needed. In particular, the `EXTRA_NDEF_MESSAGES` `Parcelable` array `extra` will return an array of `NdefMessage` objects. Typically, there will only be one of these. You can call `getRecords()` on the `NdefMessage` to get at the array of `NdefRecord` objects (again, typically only one). Methods like `getPayload()` will allow you to get at the individual portions of the record.

The nice thing is that the URL still works, even if `URLTagger` is not on the device. In that case, the `Tags` application would react to the tag, and the user could tap on it to bring up a browser on this URL. A production application might create a Web page that tells the user about this great and wonderful app the can install, and provide links to the Play Store (or elsewhere) to go get the app.

## Expected Pattern: Bootstrap

Tags tend to have limited capacity. Even in peer-to-peer settings, the effective bandwidth of NFC is paltry compared to anything outside of dial-up Internet access.

As a result, NFC will be used infrequently as the complete communications solution between a publisher and a device. Sometimes it will, when the content is specifically small, such as a contact (vCard) or event (iCalendar). But, for anything bigger than that, NFC will serve more as a convenient bootstrap for more conventional communications options:

1. Embedding a URL in a tag, as the previous sample showed, allows an installed application to run or a Web site to be browsed
2. Embedding an Play Store URL in a tag allows for easy access to some specialized app (e.g., menu for a restaurant)
3. A multi-player game might use peer-to-peer NFC to allow local participants to rapidly connect into the same shared game area, where the game is played over the Internet or Bluetooth
4. And so on.

## Mobile Devices are Mobile

Reading and writing NFC tags is a relatively slow process, mostly due to low bandwidth. It may take a second or two to actually complete the operation.

Users, however, are not known for their patience.

If a user moves their device out of range of the tag while Android is attempting to read it, Android simply will skip the dispatch. If, however, the tag leaves the signal area of the device while you are writing to it, you will get an `IOException`. At this point, the state of the tag is unknown.

You may wish to incorporate something into your UI to let the user know that you are working with the tag, encouraging them to leave the phone in place until you are done.

## Enabled and Disabled

There are two separate system settings that control NFC behavior:

- The user could have NFC disabled outright, which you would detect by calling `isEnabled()` on your `NfcAdapter`
- The user could have NFC enabled but have Android Beam disabled, which you would detect by calling `isNdefPushEnabled()` on your `NfcAdapter`

As with most enabled/disabled settings, you cannot change these values yourself. On newer Android SDK versions, though, you can try to bring up the relevant Settings screens for the user to enable these features, by using the following activity action strings from the `android.provider.Settings` class:

- `ACTION_NFC_SETTINGS` for the main NFC settings screen (added in API Level 16)
- `ACTION_NFCSHARING_SETTINGS` for the Android Beam settings screen (added in API Level 14)

## Android Beam

Android Beam is Google's moniker for peer-to-peer NFC messaging, with an emphasis — obviously — on Android apps. Rather than you tapping your NFC-capable Android device on a smart tag, you put it back-to-back with another NFC-capable Android device, and romance ensues.

Partially, this is simply one side of the exchange “pushing” an NDEF record, in a fashion that makes the other side of the exchange think that it is picking up a smart tag.



Partially, this is the concept of the “Android Application Record” (AAR), another NDEF record you can place in the NDEF message being pushed. This will identify the app you are trying to push the message to. If nothing on the device can handle the rest of the NDEF message, the AAR will lead Android to start up an app, or even lead the user to the Play Store to go download said app.

As the basis for explaining further how this all works, let’s take a look at the [NFC/WebBeam](#) sample application. The UI consists of a `WebViewFragment`, in which we can browse to some Web page. Then, running this app on two NFC-capable devices, one app can “push” the URL of the currently-viewed Web page to the other app, which will respond by displaying that page. In this fashion, we are “sharing” a URL, without one side having to type it in by hand. And, while we are using this to share a URL, you could use Android Beam to share any sort of bootstrapping data, such as the user IDs of each person, for use in connecting to some common game server.

### The Fragment

The fragment that implements our UI, `BeamFragment`, extends from the back-ported, ActionBarSherlock-friendly version of `WebViewFragment` used in various places in this book. In `onActivityCreated()`, we configure the `WebView`, load up Google’s home page, and indicate that would like to participate in the action bar (via a call to `setHasOptionsMenu()`):

```
@Override
public void onActivityCreated(Bundle savedInstanceState) {
    super.onActivityCreated(savedInstanceState);

    getWebView().setWebViewClient(new BeamClient());
    getWebView().getSettings().setJavaScriptEnabled(true);
    loadUrl("http://google.com");
    setHasOptionsMenu(true);
}
```

To keep all links within the `WebView`, we attached a `WebViewClient` implementation, named `BeamClient`, that just loads all requested URLs back into the `WebView`:

```
class BeamClient extends WebViewClient {
    @Override
    public boolean shouldOverrideUrlLoading(WebView wv, String url) {
        wv.loadUrl(url);

        return(true);
    }
}
```

## NFC

We add one item to the action bar: a toolbar button (`R.id.beam`) that will be used to indicate we wish to beam the URL in our `WebView` to another copy of this application running on another NFC-capable Android device:

```
@Override
public void onCreateOptionsMenu(Menu menu, MenuInflater inflater) {
    if (getContract().hasNFC()) {
        inflater.inflate(R.menu.actions, menu);
    }

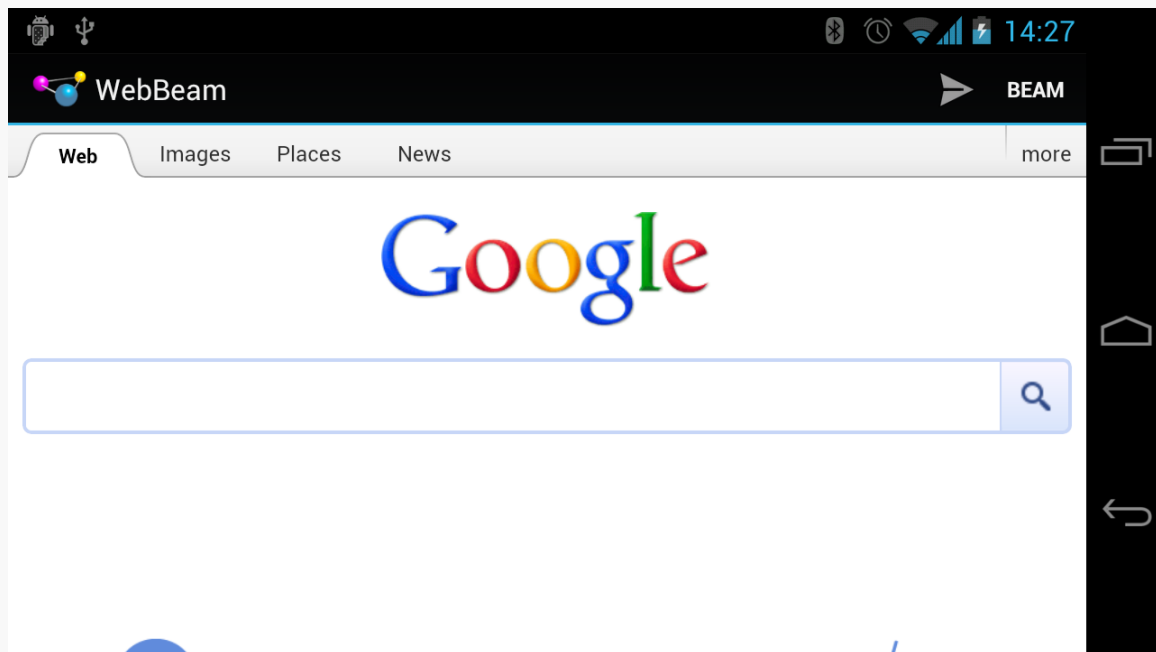
    super.onCreateOptionsMenu(menu, inflater);
}

@Override
public boolean onOptionsItemSelected(MenuItem item) {
    if (item.getItemId() == R.id.beam) {
        getContract().enablePush();

        return(true);
    }

    return(super.onOptionsItemSelected(item));
}
```

So, when the app is initially launched, it will look something like this:



*Figure 388: The WebBeam UI*

The user can use Google to find a Web page worth beaming.

### Requesting the Beam

Our hosting activity, `WebBeamActivity`, gets access to our `NfcAdapter`, as we did in the previous example:

```
adapter=NfcAdapter.getDefaultAdapter(this);
```

When the user taps on our action bar item, the fragment calls `enablePush()` on the activity. `WebBeamActivity`, in turn, calls `setNdefPushMessageCallback()` on the `NfcAdapter`, supplying two parameters:

1. An implementation of the `NfcAdapter.CreateNdefMessageCallback` interface, used to let us know when another device is in range for us to beam to (in our case, `WebBeamActivity` implements this interface)
2. Our activity that is participating in this push

If something else comes to the foreground, `onStop()` will call a corresponding `disablePush()`, which also calls `setNdefPushMessageCallback()`, specifying a null first parameter, to turn off our request to beam:

```
void enablePush() {  
    adapter.setNdefPushMessageCallback(this, this);  
}  
  
void disablePush() {  
    adapter.setNdefPushMessageCallback(null, this);  
}
```

In between the calls to `enablePush()` and `disablePush()`, if another NFC device comes in range that supports the NDEF push protocols, we're beamin'.

### Sending the Beam

When our beam-enabled device encounters another beam-capable device, our `NfcAdapter.CreateNdefMessageCallback` is called with `createNdefMessage()`, where we need to prepare the `NfcMessage` to beam to the other party:

```
@Override  
public NdefMessage createNdefMessage(NfcEvent arg0) {  
    NdefRecord uriRecord=  
        new NdefRecord(NdefRecord.TNF_MIME_MEDIA,  
            MIME_TYPE.getBytes(Charset.forName("US-ASCII"))),
```

## NFC

---

```
        new byte[0],
        beamFragment.getUrl()
            .getBytes(Charset.forName("US-ASCII"))));
    NdefMessage msg=
        new NdefMessage(
            new NdefRecord[] {
                uriRecord,
                NdefRecord.createApplicationRecord("com.commonware.android.webbeam") });
    return(msg);
```

We first create a typical `NfcRecord`, in this case of `TNF_MIME_MEDIA`, with a MIME type defined in a static data member and payload consisting of the URL from our `WebView`:

```
private static final String MIME_TYPE=
    "application/vnd.commonware.sample.webbeam";
```

You might wonder why we are using `TNF_MIME_MEDIA`, instead of `TNF_WELL_KNOWN` and a subtype of `RTD_URI`, since our payload is a URL. The reason is that we need to have a unique MIME type for our message for the whole beam process to work properly, and `TNF_WELL_KNOWN` does not support MIME types. This is also why the MIME type is something distinctive, and not just `text/plain` — it has to be something only we will pick up.

Our `NfcMessage` then consists of *two* `NfcRecord` objects: the one we just created, an one created via the static `createApplicationRecord()` method on `NfcRecord`. This helper method creates an AAR record, identifying our application by its Android package name. This record must go last – Android will try to find an app to work with based on the other records first, before “failing over” to use the AAR.

## Receiving the Beam

To receive our beam, our `WebBeamActivity` must be configured in the manifest to respond to `NDEF_DISCOVERED` actions with our unique MIME type:

```
<?xml version="1.0" encoding="utf-8"?>
<manifest xmlns:android="http://schemas.android.com/apk/res/android"
    package="com.commonware.android.webbeam"
    android:versionCode="1"
    android:versionName="1.0">

    <uses-sdk
        android:minSdkVersion="14"
        android:targetSdkVersion="14"/>
```

```
<uses-permission android:name="android.permission.INTERNET"/>
<uses-permission android:name="android.permission.NFC"/>

<application
    android:icon="@drawable/ic_launcher"
    android:label="@string/app_name"
    android:theme="@style/Theme.Sherlock">
    <activity
        android:name=".WebBeamActivity"
        android:label="@string/app_name"
        android:launchMode="singleTask"
        android:screenOrientation="landscape">
        <intent-filter>
            <action android:name="android.intent.action.MAIN"/>

            <category android:name="android.intent.category.LAUNCHER"/>
        </intent-filter>
        <intent-filter>
            <action android:name="android.nfc.action.NDEF_DISCOVERED"/>

            <category android:name="android.intent.category.DEFAULT"/>

            <data android:mimeType="application/vnd.commonware.sample.webbeam"/>
        </intent-filter>
        </activity>
    </application>
</manifest>
```

You will also notice that we set `android:launchMode="singleTask"` on this activity. That is so we will only have one instance of this activity, regardless of whether it is in the foreground or not. Otherwise, if we already have an instance of this activity, and we receive a beam, Android will create a *second* instance of this activity — when the user later presses BACK, they return to our first instance, and wonder why our app is broken.

If we receive the beam, we will get the Intent for the NDEF\_DISCOVERED action *either* in `onCreate()` (if we were not already running) or `onNewIntent()` (if we were). In either case, we want to handle it the same way: pass the URL from the first record's payload to our BeamFragment. However, we cannot do that from `onCreate()` — the fragment will not have created the `WebView` yet. So, we use a trick: calling `post()` with a `Runnable` puts that `Runnable` on the *end* of the work queue for the main application thread. We can delay our processing of the Intent by this mechanism, so we can safely assume the `WebView` exists.

```
@Override
public void onCreate(Bundle savedInstanceState) {
    super.onCreate(savedInstanceState);
```

```
        beamFragment=
(BeamFragment)getSupportFragmentManager().findFragmentById(android.R.id.content);

        if (beamFragment == null) {
            beamFragment=new BeamFragment();

            getSupportFragmentManager().beginTransaction()
                .add(android.R.id.content, beamFragment)
                .commit();
        }

        adapter=NfcAdapter.getDefaultAdapter(this);

        findViewById(android.R.id.content).post(new Runnable() {
            public void run() {
                handleIntent(getIntent());
            }
        });
    }

    @Override
    public void onNewIntent(Intent i) {
        handleIntent(i);
    }

    private void handleIntent(Intent i) {
        if (NfcAdapter.ACTION_NDEF_DISCOVERED.equals(i.getAction())) {
            Parcelable[] rawMsgs=
                i.getParcelableArrayExtra(NfcAdapter.EXTRA_NDEF_MESSAGES);
            NdefMessage msg=(NdefMessage)rawMsgs[0];
            String url=new String(msg.getRecords()[0].getPayload());

            beamFragment.loadUrl(url);
        }
    }
}
```

## The Scenarios

There are three possible scenarios, when we try beaming from one device to another:

1. The other device has our application installed, and it is running. In that case, our activity is brought to the foreground and the Intent is delivered to it, courtesy of our NDEF\_DISCOVERED <intent-filter> with our unique MIME type.
2. The other device has our application installed, but it is not running. Android's Intent system handles this in the same general fashion as the first

scenario, though it starts up a process for us and creates our activity instance anew in this case.

3. The other device does not have our application installed. Since nothing (hopefully) claims to support our unique MIME type, the AAR takes effect, and the user is led to the Play Store to go download our app (or, in this case, display an error message, as WebBeam is not in the Play Store).

## Beaming Files

Android 4.1 (a.k.a., Jelly Bean) added in a far simpler facility for an app to beam a file to another device using the Android Beam system. You can use `setBeamPushUri()` or `setBeamPushUriCallback()` on an `NfcAdapter` to hand Android one or more `Uri` objects representing files to be transferred. While the initial connection will be made via NFC and Android Beam, the actual data transfer will be via Bluetooth or WiFi, much more suitable than NFC for bulk data.

The difference between the two approaches is mostly when you provide the array of `Uri` objects. With `setBeamPushUri()`, you initiate the beam operation and supply the `Uri` values immediately. With `setBeamPushUriCallback()`, you initiate the beam but do not supply the `Uri` values until the beam connection is established with the peer app.

The [NFC/FileBeam](#) sample application shows file-based beaming in action.

In our activity (`MainActivity`), in `onCreate()`, we check to make sure that Android Beam is enabled, via a call to `isNdefPushEnabled()` on our `NfcAdapter`. If it is, then we use `ACTION_GET_CONTENT` to retrieve some file from the user (MIME type wildcard of `*/*`):

```
@Override
public void onCreate(Bundle savedInstanceState) {
    super.onCreate(savedInstanceState);
    adapter=NfcAdapter.getDefaultAdapter(this);

    if (!adapter.isNdefPushEnabled()) {
        Toast.makeText(this, R.string.sorry, Toast.LENGTH_LONG).show();
        finish();
    }
    else {
        Intent i=new Intent(Intent.ACTION_GET_CONTENT);

        i.setType("*/*");
        startActivityForResult(i, 0);
    }
}
```

```
}  
}
```

In `onActivityResult()`, if we actually got a file (e.g., the result is `ACTION_OK`), we turn around and call `setBeamPushUri()` to pass that file to some peer device. We also set up a `Button` as our UI — clicking the `Button` will `finish()` the activity:

```
@Override  
protected void onActivityResult(int requestCode, int resultCode,  
                                Intent data) {  
    if (requestCode==0 && resultCode==RESULT_OK) {  
        adapter.setBeamPushUri(new Uri[] {data.getData()}, this);  
  
        Button btn=new Button(this);  
  
        btn.setText(R.string.over);  
        btn.setOnClickListener(this);  
        setContentView(btn);  
    }  
}
```

That is all there is to it. If you run this app and pick a file, then hold the device up to another Android 4.1+ device, you will be prompted to “Touch to Beam” — doing so will kick off the transfer. Once the transfer is shown on the receiving device, you can pull the devices apart a bit, as the transfer will be proceeding over Bluetooth or WiFi. However, while Bluetooth ranges are much longer than NFC, you still need to keep the devices within a handful of meters of one another.

Note that the receiving device is not running our app. The OS handles the receipt of the transferred file, not our code. Similarly, the OS on the sending device is really the one responsible for the file transfer, so our app does not need the `INTERNET` or `BLUETOOTH` permissions. The downside is that we have no control over anything on the receiving side — the file is stored wherever the OS elects to put it, and the Notification it displays when complete will simply launch `ACTION_VIEW` on the pushed file.

## Another Sample: SecretAgentMan

To provide another take on using these features of `NfcAdapter`, let’s examine the [NFC/SecretAgentMan](#) sample application, originally written for a presentation at the 2012 droidcon UK conference. This combines writing to tags, directly beaming text to another device, and using `Uri`-based beaming, all in one app.

The UI of the app is a large `EditText` widget with an action bar:



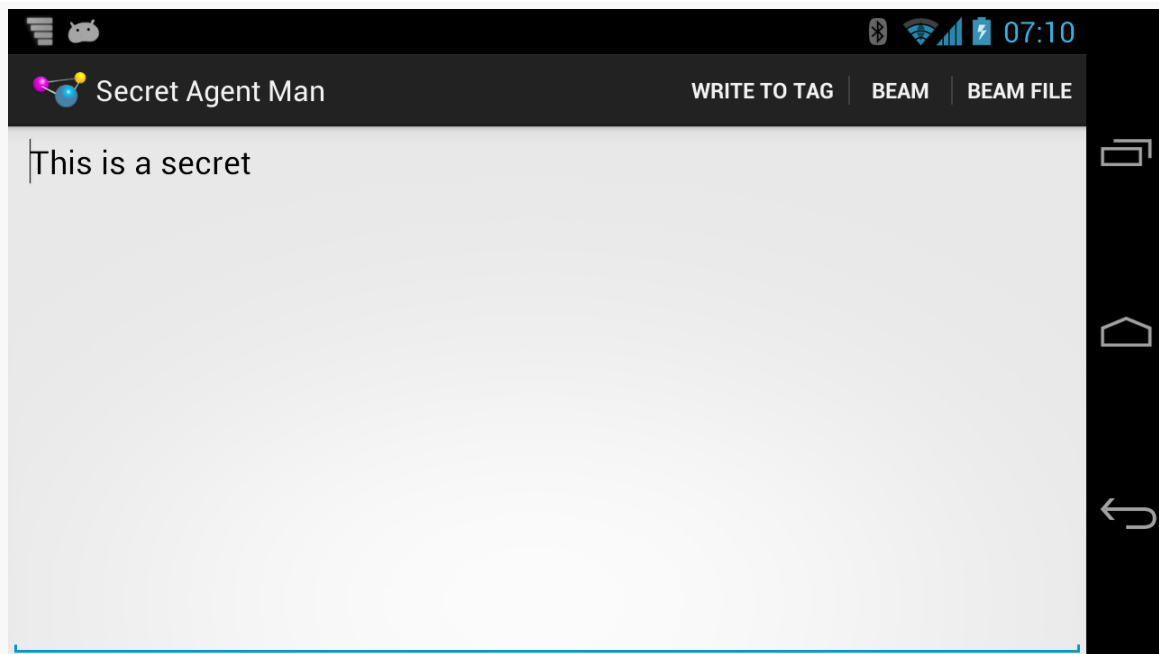


Figure 389: The SecretAgentMan UI

There are three action bar items, one each for the three operations: writing to a tag, directly beaming to another device, and beaming a file (represented via a `Uri`).

## Configuration and Initialization

Our app is comprised of a single activity, named `MainActivity`. As part of our manifest setup, we request the NFC permission. And, since the app needs NFC to be useful, we also have a `<uses-feature>` element, stipulating that the device needs to have NFC, otherwise the app should not be shown in the Play Store:

```
<uses-permission android:name="android.permission.NFC"/>

<uses-feature
    android:name="android.hardware.nfc"
    android:required="true"/>
```

In `onCreate()` of `MainActivity`, we can then safely get access to an `NfcAdapter`, since the NFC hardware should exist and we have rights to use NFC:

```
@Override
public void onCreate(Bundle savedInstanceState) {
    super.onCreate(savedInstanceState);
    setContentView(R.layout.activity_main);
}
```

## NFC

---

```
nfc=NfcAdapter.getDefaultAdapter(this);
secretMessage=(EditText)findViewById(R.id.secretMessage);

nfc.setOnNdefPushCompleteCallback(this, this);

if (NfcAdapter.ACTION_NDEF_DISCOVERED.equals(getIntent().getAction())) {
    readFromTag(getIntent());
}
}
```

We also get our hands on the EditText widget, storing a reference to it in a data member named secretMessage. We will cover the rest of the initialization work in onCreate() later in this section, as we cover the code that needs that initialization.

### Writing to the Tag

If the user chooses the “Write to Tag” action bar item, we call a setUpWriteMode() method from onOptionsItemSelected() of MainActivity. We maintain an inWriteMode boolean data member to track whether or not we are already trying to write to an NFC tag. If inWriteMode is false, we go ahead and take control over the NFC hardware to attempt to write to the next tag we see:

```
void setUpWriteMode() {
    if (!inWriteMode) {
        IntentFilter discovery=
            new IntentFilter(NfcAdapter.ACTION_TAG_DISCOVERED);
        IntentFilter[] tagFilters=new IntentFilter[] { discovery };
        Intent i=
            new Intent(this, getClass()).addFlags(Intent.FLAG_ACTIVITY_SINGLE_TOP
                | Intent.FLAG_ACTIVITY_CLEAR_TOP);
        PendingIntent pi=PendingIntent.getActivity(this, 0, i, 0);

        inWriteMode=true;
        nfc.enableForegroundDispatch(this, pi, tagFilters, null);
    }
}
```

To do that, we:

- Create an IntentFilter for ACTION\_TAG\_DISCOVERED
- Create a PendingIntent for an Intent pointing back to this same activity instance (using getClass() to identify the instance, plus FLAG\_ACTIVITY\_SINGLE\_TOP and FLAG\_ACTIVITY\_CLEAR\_TOP to route control back to our running instance)
- Call enableForegroundDispatch() on our NfcAdapter, to route newly-discovered tags to us, with the IntentFilter identifying the tag-related

## NFC

---

events we are interested in, and the `PendingIntent` identifying what to do when such a tag is encountered

Once our activity is finishing (e.g., the user presses `BACK`), we need to clean up our write-to-tag logic. This is kicked off in `onPause()` of `MainActivity`:

```
@Override
public void onPause() {
    if (isFinishing()) {
        cleanUpWritingToTag();
    }

    super.onPause();
}
```

All we do in `cleanUpWritingToTag()` is discontinue our foreground control over the NFC hardware:

```
void cleanUpWritingToTag() {
    nfc.disableForegroundDispatch(this);
    inWriteMode=false;
}
```

If, before that occurs, the device is tapped on a tag, our activity should regain control in `onNewIntent()` as a result of our `PendingIntent` having been executed:

```
@Override
protected void onNewIntent(Intent i) {
    if (inWriteMode
        && NfcAdapter.ACTION_TAG_DISCOVERED.equals(i.getAction())) {
        writeToTag(i);
    }
    else if (NfcAdapter.ACTION_NDEF_DISCOVERED.equals(i.getAction())) {
        readFromTag(i);
    }
}
```

If we are in write mode, and if the `Intent` that was just used with `startActivity()` was `ACTION_TAG_DISCOVERED`, we call our `writeToTag()` method to actually start writing information to the tag:

```
void writeToTag(Intent i) {
    Tag tag=i.getParcelableExtra(NfcAdapter.EXTRA_TAG);
    NdefMessage msg=
        new NdefMessage(new NdefRecord[] { buildNdefRecord() });

    new WriteTagTask(this, msg, tag).execute();
}
```

## NFC

---

To write to the tag, we get our Tag out of its Intent extra (keyed by EXTRA\_TAG). Then, we build an NdefMessage to write to the tag, getting its NdefRecord from buildNdefRecord():

```
NdefRecord buildNdefRecord() {
    return(new NdefRecord(NdefRecord.TNF_MIME_MEDIA,
        MIME_TYPE.getBytes(), new byte[] {},
        secretMessage.getText().toString().getBytes()));
}
```

Our NDEF record will be of a specific MIME type, represented by a static data member named MIME\_TYPE:

```
private static final String MIME_TYPE="vnd.secret/agent.man";
```

The payload of the NDEF record is our “secret message” from the secretMessage EditText widget.

The writeToTag() method then kicks off the same WriteTagTask that we used earlier in this chapter:

```
package com.commonware.android.jimmyb;

import android.nfc.NdefMessage;
import android.nfc.Tag;
import android.nfc.tech.Ndef;
import android.nfc.tech.NdefFormatable;
import android.os.AsyncTask;
import android.util.Log;
import android.widget.Toast;

class WriteTagTask extends AsyncTask<Void, Void, Void> {
    MainActivity host=null;
    NdefMessage msg=null;
    Tag tag=null;
    String text=null;

    WriteTagTask(MainActivity host, NdefMessage msg, Tag tag) {
        this.host=host;
        this.msg=msg;
        this.tag=tag;
    }

    @Override
    protected Void doInBackground(Void... arg0) {
        int size=msg.toByteArray().length;

        try {
            Ndef ndef=Ndef.get(tag);
```

## NFC

---

```
if (ndef == null) {
    NdefFormatable formatable=NdefFormatable.get(tag);

    if (formatable != null) {
        try {
            formatable.connect();

            try {
                formatable.format(msg);
            }
            catch (Exception e) {
                text=host.getString(R.string.tag_refused_to_format);
            }
        }
        catch (Exception e) {
            text=host.getString(R.string.tag_refused_to_connect);
        }
        finally {
            formatable.close();
        }
    }
    else {
        text=host.getString(R.string.tag_does_not_support_ndef);
    }
}
else {
    ndef.connect();

    try {
        if (!ndef.isWritable()) {
            text=host.getString(R.string.tag_is_read_only);
        }
        else if (ndef.getMaxSize() < size) {
            text=host.getString(R.string.message_is_too_big_for_tag);
        }
        else {
            ndef.writeNdefMessage(msg);
            text=host.getString(R.string.success);
        }
    }
    catch (Exception e) {
        text=host.getString(R.string.tag_refused_to_connect);
    }
    finally {
        ndef.close();
    }
}
}
catch (Exception e) {
    Log.e("URLEncoder", "Exception when writing tag", e);
    text=host.getString(R.string.general_exception) + e.getMessage();
}

return(null);
```

```
}  
  
@Override  
protected void onPostExecute(Void unused) {  
    host.cleanupWritingToTag();  
  
    if (text != null) {  
        Toast.makeText(host, text, Toast.LENGTH_SHORT).show();  
    }  
}  
}
```

The net result is that if the user taps the “Write to Tag” action bar item, then taps and holds the device to a tag, we will write a message to the tag and display a Toast when we are done.

And, yes, this is a surprising amount of code for what really should be a simple operation...

### Reading from the Tag

We can set up MainActivity to respond to tags similar to the one we wrote — ones that have the desired MIME Type — via an `android.nfc.action.NDEF_DISCOVERED` `<intent-filter>`:

```
<intent-filter android:label="@string/app_name">  
    <action android:name="android.nfc.action.NDEF_DISCOVERED"/>  
  
    <data android:mimeType="vnd.secret/agent.man"/>  
  
    <category android:name="android.intent.category.DEFAULT"/>  
</intent-filter>
```

In both `onCreate()` and `onNewIntent()`, if the Intent that started our activity is an `NDEF_DISCOVERED` Intent, we route control to a `readFromTag()` method:

```
void readFromTag(Intent i) {  
    Parcelable[] msgs=  
        (Parcelable[])i.getParcelableArrayExtra(NfcAdapter.EXTRA_NDEF_MESSAGES);  
  
    if (msgs.length > 0) {  
        NdefMessage msg=(NdefMessage)msgs[0];  
  
        if (msg.getRecords().length > 0) {  
            NdefRecord rec=msg.getRecords()[0];  
  
            secretMessage.setText(new String(rec.getPayload(), US_ASCII));  
        }  
    }  
}
```

```
}  
}
```

In principle, there could be several NDEF messages on the tag, but we only pay attention to the first element, if any, of the `EXTRA_NDEF_MESSAGES` array of `Parcelable` objects on the `Intent`. Similarly, in principle, there could be several NDEF records in the first message, but we only examine the first element out of the array of `NdefRecord` objects contained in the `NdefMessage`. From there, we extract our secret message and display it by means of putting it in the `EditText` widget.

### Beaming the Text

This sample only supports beaming — whether of NDEF messages directly or of a file — if we are on API Level 16 or higher. Hence, in `onCreateOptionsMenu()`, we check our version and only enable our default-disabled beam action bar items if:

- We are on API Level 16 or higher, and
- NDEF push mode is enabled, via a call to `isNdefPushEnabled()` on our `NfcAdapter`:

```
@TargetApi(16)  
@Override  
public boolean onCreateOptionsMenu(Menu menu) {  
    getMenuInflater().inflate(R.menu.activity_main, menu);  
  
    if (Build.VERSION.SDK_INT >= Build.VERSION_CODES.JELLY_BEAN) {  
        menu.findItem(R.id.simple_beam)  
            .setEnabled(nfc.isNdefPushEnabled());  
        menu.findItem(R.id.file_beam).setEnabled(nfc.isNdefPushEnabled());  
    }  
  
    return(super.onCreateOptionsMenu(menu));  
}
```

If the user taps on the “Beam” action bar item, we call an `enablePush()` method from `onOptionsItemSelected()`, which simply enables push mode:

```
void enablePush() {  
    nfc.setNdefPushMessageCallback(this, this);  
}
```

We arrange for the activity itself to be the `CreateNdefMessageCallback` necessary for push mode. That requires us to implement `createNdefMessage()`, which will be called if we are in push mode and a push-compliant device comes within range:

## NFC

---

```
@Override
public NdefMessage createNdefMessage(NfcEvent event) {
    return(new NdefMessage(
        new NdefRecord[] {
            buildNdefRecord(),
            NdefRecord.createApplicationRecord("com.commonware.android.jimmyb") }));
}
```

Here, we create an `NdefMessage` similar to the one we wrote to the tag earlier in this sample. However, we also attach an Android Application Record (AAR), by means of the static `createApplicationRecord()` method on `NdefRecord`. This, in theory, will help route the push to our app on the other device, including downloading it from the Play Store if needed (and, of course, if it actually existed on the Play Store, which it does not).

Back up in `onCreate()`, we call `setOnNdefPushCompleteCallback()`, to be notified of when a push operation is completed. Once again, we set up `MainActivity` to be the callback, this time by implementing the `OnNdefPushCompleteCallback` interface. That, in turn, requires us to implement `onNdefPushComplete()`, where we disable push mode via a call to `setNdefPushMessageCallback()` with a null listener:

```
@Override
public void onNdefPushComplete(NfcEvent event) {
    nfc.setNdefPushMessageCallback(null, this);
}
```

To receive the beam, we only need our existing logic to read from the tag, as on the receiving side, a push is indistinguishable from reading a tag, and we are using the same MIME type for both the message written to the tag and the message we are pushing.

### Beaming the File

If the user taps the “Beam File” action bar item, we find some file to beam, by means of an `ACTION_GET_CONTENT` request and `startActivityForResult()`:

```
case R.id.file_beam:
    Intent i=new Intent(Intent.ACTION_GET_CONTENT);

    i.setType("*/*");
    startActivityForResult(i, 0);
    return(true);
```



## NFC

---

In `onActivityResult()`, if the request succeeded, we use `setBeamPushUri()` to tell Android to beam the selected file to another device. Nothing more is needed on our side, and the receipt of the file is handled entirely by the OS, not our application code, so there is nothing to be written for that.

This code assumes the NFC adapter is enabled. We could check that via a call to `isEnabled()` on our `NfcAdapter`. If it is not enabled, we could — on user request — bring up the Settings activity for configuring NFC, via `startActivity(new Intent(Settings.ACTION_NFC_SETTINGS))`. However, oddly, this Intent action is only available on Android 4.1 (API Level 16) and higher, despite NFC having been available for some time previously.

This code ignores the possibility of doing the simple beam (not the file-based beam) on Android 4.0.x devices. That is because the `isNdefPushEnabled()` method was not added until Android 4.1, and therefore we do not know whether or not we can actually do a beam.

If `isNdefPushEnabled()` returns false, we simply disable some action bar items. Alternatively, we could use `startActivity(new Intent(Settings.ACTION_NFC_SHARING_SETTINGS))`, on API Level 14 and higher, to bring up the beam screen in Settings, to allow the user to toggle beam support on.

## Additional Resources

To help make sense of the tags that you are trying to use with your app, you may wish to grab the [NFC TagInfo](#) application off of the Google Play Store. This application simply scans a tag and allows you to peruse all the details of that tag, including the supported technologies (e.g., does it support NDEF? is it `NdefFormatable?`), the NDEF records, and so on.

To learn more about NFC on Android — beyond this chapter or the Android developer documentation — [this Google I/O 2011 presentation](#) is recommended.

# Device Administration

---

Balding authors of Android books often point out that enterprises and malware authors have the same interests: they want to take control of a device away from the person that is holding it and give that control to some other party. Android, being a consumer operating system, is designed to defend against malware, and so enterprises can run into issues.

However, Android does have a growing area of device administration APIs, that allow carefully-constructed and installed applications to exert some degree of control over the device, how it is configured, and how it operates.

## Prerequisites

Understanding this chapter requires that you have read the core chapters, particularly the chapter on [broadcast Intents](#).

## Objectives and Scope

One might read the phrase “device administration” and assume that somebody, using these APIs, could do anything they want on the device.

That’s not quite what “device administration” means in this case.

Rather, the device administration APIs serve three main roles:

1. They allow an application to dictate how well a device is secured, from the password required in the OS lock screen to whether the device should have full-disk encryption

2. They allow an application to find out when security issues might arise, notably failed password attempts
3. They allow an application to lock the device, disable its cameras, or even perform a “wipe” (i.e., factory reset)

The user, however, has to agree to enable a device administration app. It does not magically get all these powers simply by being installed. What the user gets from agreeing to this is access to something that otherwise would be denied (e.g., to use Enterprise App X, you must agree to allow it to be a device administrator).

## Defining and Registering an Admin Component

There are four pieces for defining and registering a device administration app: creating the metadata, adding the `<receiver>` to the manifest, implementing that `BroadcastReceiver`, and telling Android to ask the user to agree to allow the app to a device administrator.

Here, we will take a peek at the [DeviceAdmin/LockMeNow](#) sample application.

### The Metadata

As with [app widgets](#) and other Android facilities, you will need to define a metadata file as an XML resource, describing in greater detail what your device administration app wishes to do. This information will determine what you will be allowed to do once the user approves your app, and what you list here will be displayed to the user when you request such approval.

The `DeviceAdminInfo` class has a series of static data members (e.g., `USES_ENCRYPTED_STORAGE`) that represent specific policies that your device administrator app could use. The documentation for each of those static data members lists the corresponding element that goes in this XML metadata file (e.g., `<encrypted-storage>`). These elements are wrapped in a `<uses-policies>` element, which itself is wrapped in a `<device-admin>` element. The range of possible policies is shown in the following sample XML metadata file:

```
<device-admin xmlns:android="http://schemas.android.com/apk/res/android">
  <uses-policies>
    <disable-camera />
    <encrypted-storage />
    <expire-password />
    <force-lock />
    <limit-password />
  </uses-policies>
</device-admin>
```

```
<reset-password />
<watch-login />
<wipe-data />
</uses-policies>
</device-admin>
```

Here, we:

- Intend to disable the cameras, if needed
- Will ask the user to encrypt their device storage, if it has not been done already
- Will set an expiration time for the user's password, after which they will need to set up a new one
- Intend to lock the device, if needed
- Will set criteria for password quality, such as minimum length
- Intend to forcibly reset the user's password, if needed
- Intend to monitor for failed and successful login attempts
- Intent to wipe the device, if needed

Choose which of those policies you need — the fewer you request, the more likely it is the user will not wonder about your intentions. In your project's `res/xml/` directory, create a file that looks like the above with the policies you wish. You can name this file whatever you want (e.g., `device_admin.xml`), within standard Android resource naming rules.

### The Manifest

In the manifest, you will need to declare a `<receiver>` element for the `DeviceAdminReceiver` component that you will write. This component not only is the embodiment of the device admin capabilities of your app, but it will be the one notified of failed logins and other events.

For example, here is the `<receiver>` element from the `LockMeNow` sample app:

```
<receiver
  android:name="AdminReceiver"
  android:permission="android.permission.BIND_DEVICE_ADMIN">
  <meta-data
    android:name="android.app.device_admin"
    android:resource="@xml/device_admin"/>

  <intent-filter>
    <action android:name="android.app.action.DEVICE_ADMIN_ENABLED"/>
  </intent-filter>
</receiver>
```

## DEVICE ADMINISTRATION

---

There are three things distinctive about this element compared to your usual `<receiver>` element:

1. It requires that whoever sends broadcasts to it hold the `BIND_DEVICE_ADMIN` permission. Since that permission is protected and can only be held by apps signed with the firmware's signing key, you can be reasonably assured that any events sent to you are real.
2. It has the `<meta-data>` child element pointing to our device administration metadata from the previous section.
3. It registers for `android.app.action.DEVICE_ADMIN_ENABLED` broadcasts via its `<intent-filter>` — this is the broadcast that will be used to notify you about failed logins or other events.

### The Receiver

The `DeviceAdminReceiver` itself needs to exist as a component in your app, registered in the manifest as shown above. At minimum, though, it does not need to override any methods, such as the implementation from the `LockMeNow` sample app:

```
package com.commonware.android.lockme;

import android.app.admin.DeviceAdminReceiver;

public class AdminReceiver extends DeviceAdminReceiver {
}
```

By requesting the `DEVICE_ADMIN_ENABLED` broadcasts, we could get control when we are enabled by overriding an `onEnabled()` method. We could also register for other broadcasts (e.g., `ACTION_PASSWORD_FAILED`) and implement the corresponding callback method on our `DeviceAdminReceiver` (e.g., `onPasswordFailed()`).

### The Demand for Device Domination

Simply having this component in our manifest, though, is insufficient. The user must proactively agree to allow us to administer their device. And, since this is potentially very dangerous, a simple permission was deemed to also be insufficient. Instead, we need to ask the user to approve us as a device administrator from our app, typically from an activity.

In the case of `LockMeNow`, the UI is just a really big button, tied to a `lockMeNow()` method on our `LockMeNowActivity`:

## DEVICE ADMINISTRATION

---

```
<?xml version="1.0" encoding="utf-8"?>
<LinearLayout xmlns:android="http://schemas.android.com/apk/res/android"
    android:layout_width="fill_parent"
    android:layout_height="fill_parent"
    android:orientation="vertical">

    <Button
        android:id="@+id/Button1"
        android:layout_width="fill_parent"
        android:layout_height="match_parent"
        android:onClick="lockMeNow"
        android:text="@string/lock_me"
        android:textColor="#FFFF0000"
        android:textSize="40sp"
        android:textStyle="bold"/>

</LinearLayout>
```

In `onCreate()` of the activity, in addition to loading up the UI via `setContentView()`, we create a `ComponentName` object identifying our `AdminReceiver` component. We also request access to the `DevicePolicyManager`, via a call to `getSystemService()`. `DevicePolicyManager` is our gateway for making direct requests for device administration operations, such as locking the device:

```
package com.commonsware.android.lockme;

import android.app.Activity;
import android.app.admin.DevicePolicyManager;
import android.content.ComponentName;
import android.content.Intent;
import android.os.Bundle;
import android.view.View;

public class LockMeNowActivity extends Activity {
    private DevicePolicyManager mgr=null;
    private ComponentName cn=null;

    @Override
    public void onCreate(Bundle savedInstanceState) {
        super.onCreate(savedInstanceState);

        setContentView(R.layout.main);
        cn=new ComponentName(this, AdminReceiver.class);
        mgr=(DevicePolicyManager)getSystemService(DEVICE_POLICY_SERVICE);
    }

    public void lockMeNow(View v) {
        if (mgr.isAdminActive(cn)) {
            mgr.lockNow();
        }
        else {
            Intent intent=
```

## DEVICE ADMINISTRATION

---

```
        new Intent(DevicePolicyManager.ACTION_ADD_DEVICE_ADMIN);
        intent.putExtra(DevicePolicyManager.EXTRA_DEVICE_ADMIN, cn);
        intent.putExtra(DevicePolicyManager.EXTRA_ADD_EXPLANATION,
            getString(R.string.device_admin_explanation));
        startActivity(intent);
    }
}
```

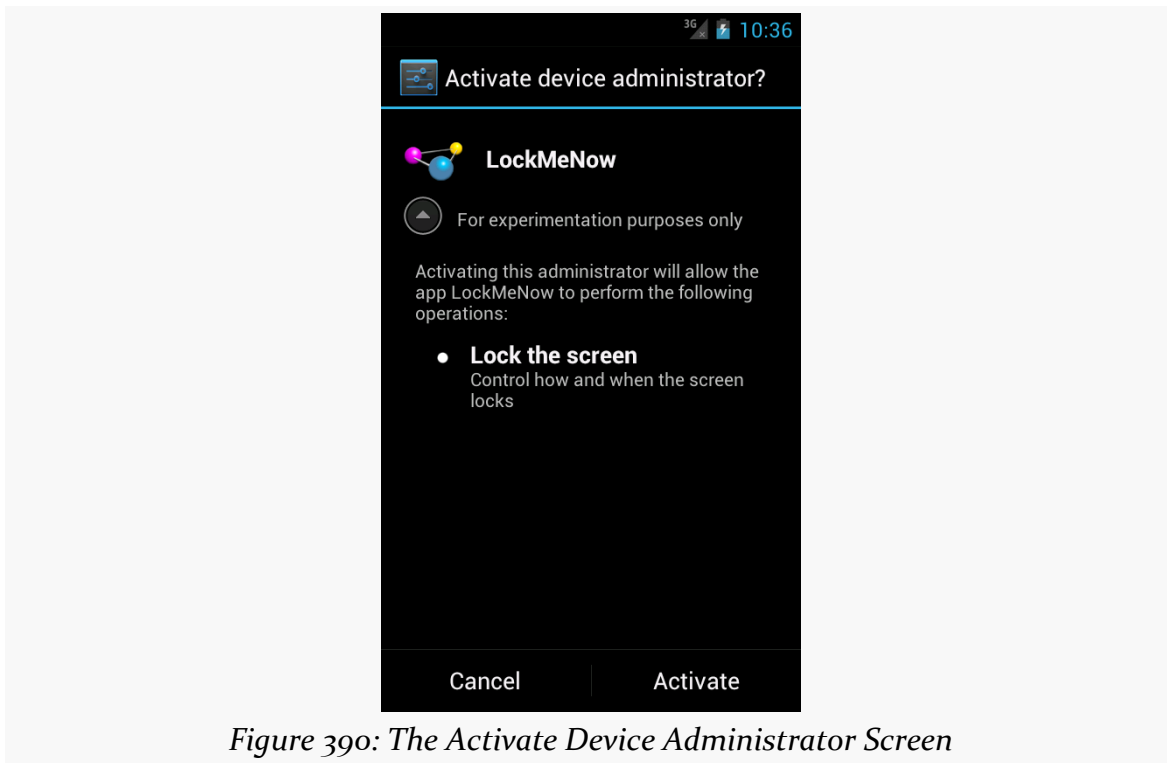
In `lockMeNow()`, we ask the `DevicePolicyManager` if we have already been registered as a device administrator, by calling `isAdminActive()`, supplying the `ComponentName` of our `DeviceAdminReceiver` that should be so registered. If that returns `false`, then the user has not approved us as a device administrator yet, so we need to ask them to do so. To do that, you:

- Create an `Intent` for the `DevicePolicyManager.ACTION_ADD_DEVICE_ADMIN` action
- Add the `ComponentName` of our `DeviceAdminReceiver` as an extra, keyed as `DevicePolicyManager.EXTRA_DEVICE_ADMIN`
- Add another extra, `DevicePolicyManager.EXTRA_ADD_EXPLANATION`, which is some text to show the user as part of the authorization screen, to explain why we need to be a device admin
- Start up an activity using that `Intent`, via `startActivity()`

If you run this on a device, then tap the button, the first time you do so the user will be prompted to agree to making the app be a device administrator:

## DEVICE ADMINISTRATION

---

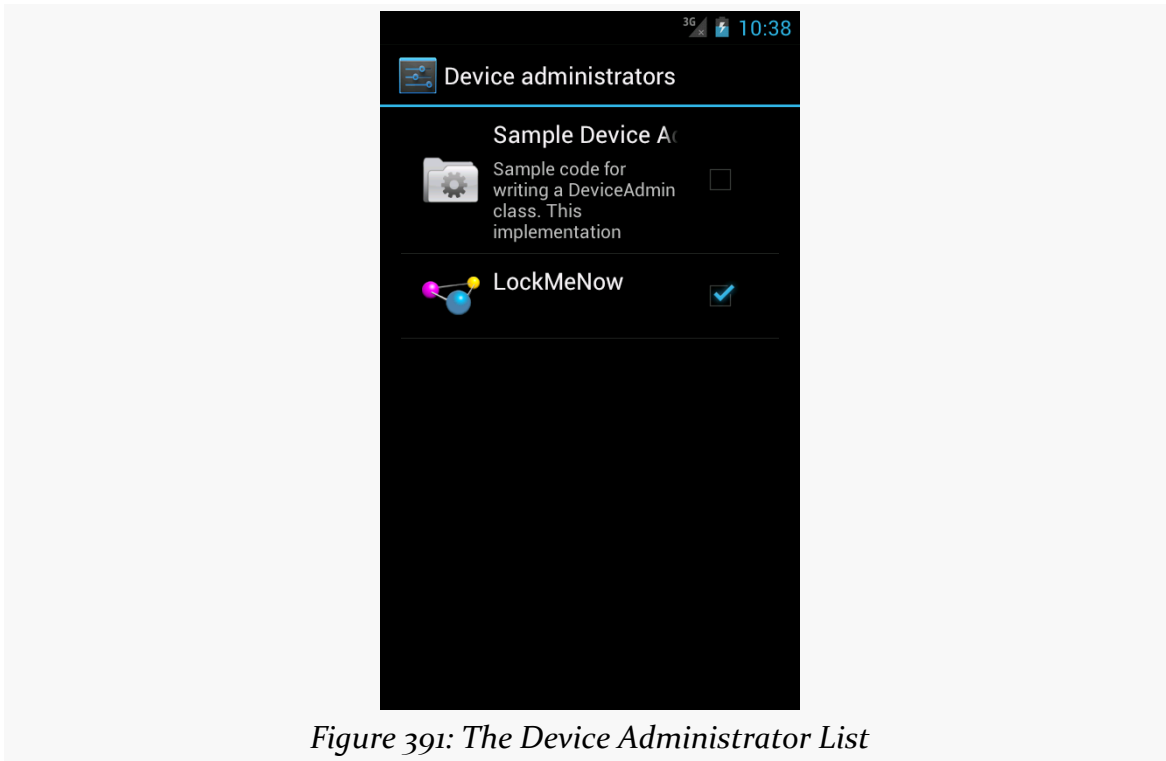


*Figure 390: The Activate Device Administrator Screen*

The “For experimentation purposes only” is the value of our `DevicePolicyManager.EXTRA_ADD_EXPLANATION` extra, loaded from a string resource.

If the user clicks “Activate”, and you override `onEnabled()` in your `DeviceAdminReceiver`, that will be called to let you know that you have been approved and can perform device administration functions. Your component will also appear in the list of device administrators in the Settings app:





*Figure 391: The Device Administrator List*

The user can, at any time, uncheck you in this list and disable you. You can find out about this by having your `DeviceAdminReceiver` listen for `ACTION_DEVICE_ADMIN_DISABLE_REQUESTED` broadcasts and overriding the `onDisableRequested()` method, where you can return the text of a message to be displayed to the user confirming that they do indeed wish to go ahead with the disable operation. To find out if they go through with it, your `DeviceAdminReceiver` can listen for `ACTION_DEVICE_ADMIN_DISABLED` broadcasts and override `onDisabled()`.

## Going Into Lockdown

Given that the user has approved your device administration request, and given that you requested `<force-lock>` in your metadata, you can call `lockNow()` on a `DevicePolicyManager`. That will immediately lock the device and (generally) turn off the screen. It is as if the user pressed the `POWER` button on the device.

The `LockItNow` sample app does this if, when the user clicks the really big button, it detects that it is already a device administrator. If you test this on a device, it will

behave as though the user pressed POWER; on an emulator, you will need to press the HOME button to “power on” the screen and be able to re-enter your emulator.

You can also call:

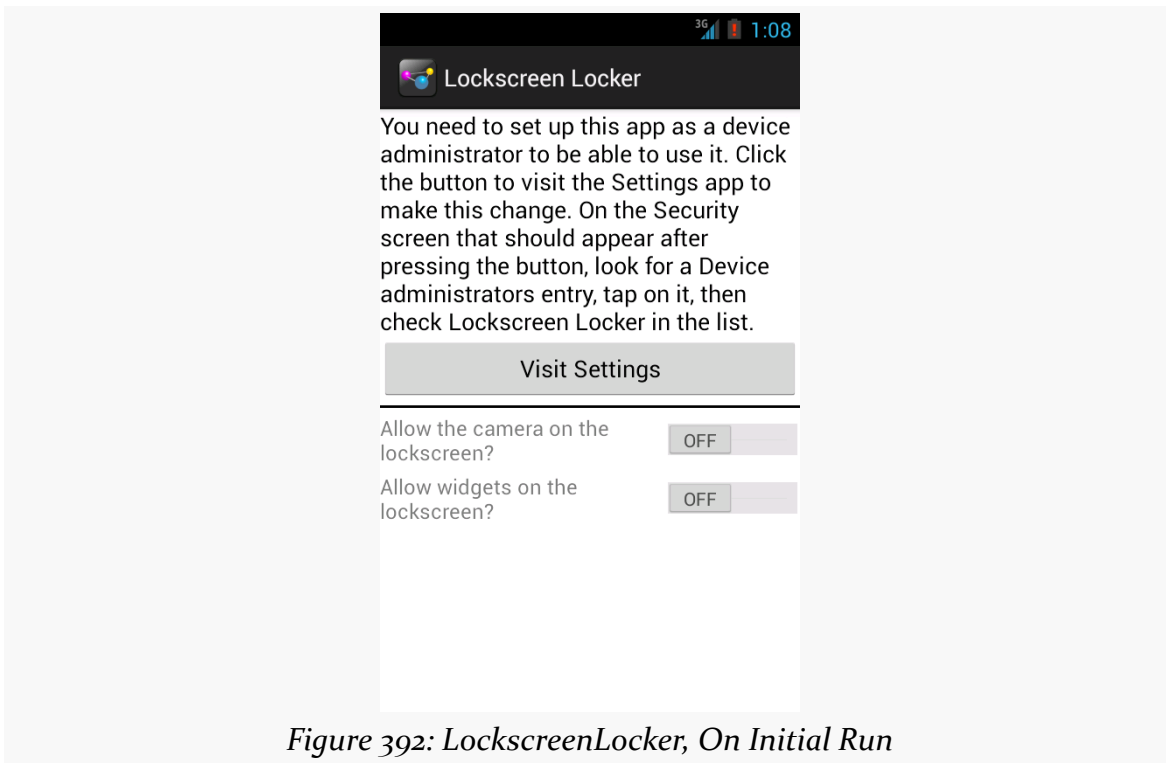
- `setCameraDisabled()` to disable all cameras, if you requested `<disable-camera>` in the metadata. Note that this disables all cameras; there is no provision at this time to disable individual cameras separately.
- `wipeData()`, which performs what amounts to a factory reset — it leaves external storage alone but wipes the contents of internal storage as part of a reboot. This requires the `<wipe-data>` policy in the metadata.
- `setKeyguardDisabledFeatures()`, to control whether or not the lockscreen allows direct access to the camera and/or app widgets (lockscreen app widgets are described in [the chapter on app widgets](#))

For example, the latter feature, while available in the Android SDK, is not built into the Settings app of Android 4.2. As a result, users need a third-party app to toggle on or off lockscreen access to the camera and app widgets. One such third-party app is [LockscreenLocker](#), released as open source by the author of this book.

Basically, the app presents you with two Switch widgets to control the camera and app widgets on the lock screen. First, though, it shows you a message and a Button, if the app is not set up as a device administrator:

## DEVICE ADMINISTRATION

---

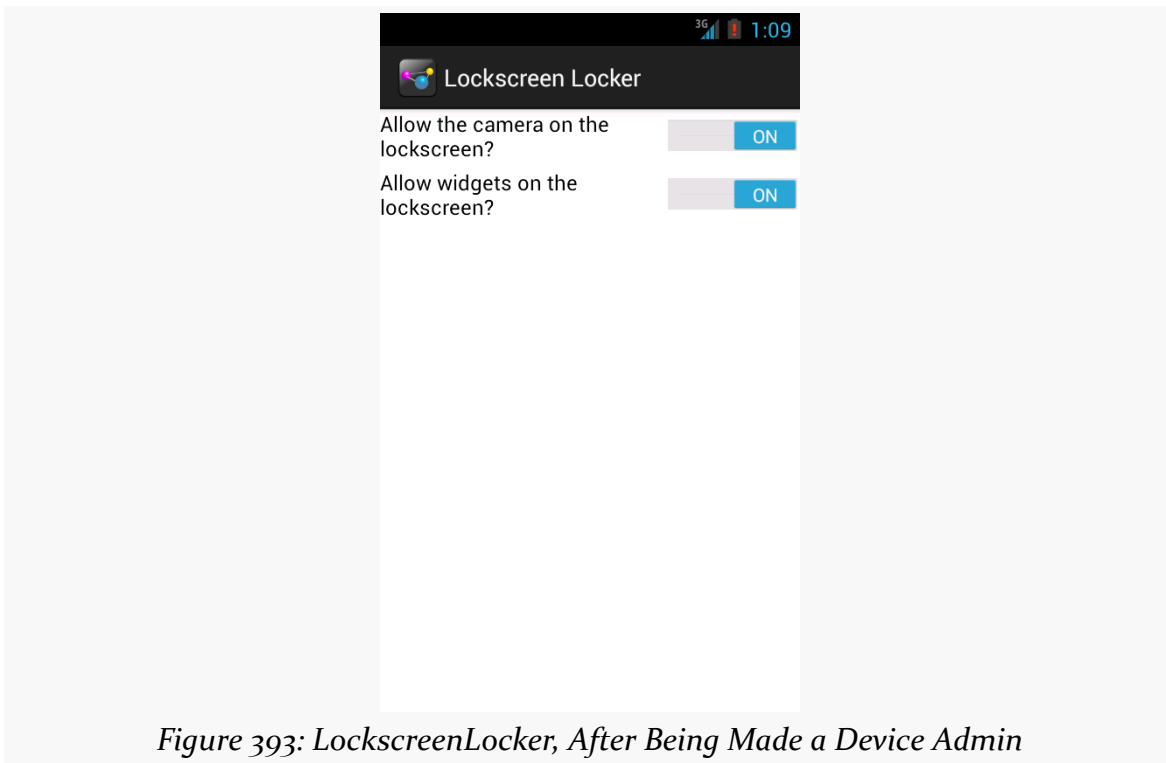


*Figure 392: LockscreenLocker, On Initial Run*

Once that is complete, the Switch widgets become enabled and usable:

## DEVICE ADMINISTRATION

---



*Figure 393: LockscreenLocker, After Being Made a Device Admin*

The device admin metadata for this app specifies that we want to control keyguard features:

```
<device-admin xmlns:android="http://schemas.android.com/apk/res/android">
  <uses-policies>
    <disable-keyguard-features/>
  </uses-policies>
</device-admin>
```

Note that, at the time of this writing, there is a flaw in the Android developer documentation — the correct element to have in the metadata is `<disable-keyguard-features/>`, not `<disable-keyguard-widgets/>`. You can track [this issue](#) to see when this documentation bug has been repaired.

Our device admin component, `LockscreenAdminReceiver`, is empty, because there are no events that we are trying to listen to:

```
public class LockscreenAdminReceiver extends DeviceAdminReceiver {
}
```

However, we still need the `LockscreenAdminReceiver`, as it is the component that is tied to our device admin metadata and indicates to the system that we should be an option in Settings for available device administrators.

Our activity layout contains all the requisite widgets: a `TextView` for the message, a `Button` to jump to the Settings app, a `View` to serve as a divider, and a pair of `Switch` widgets to manage the lockscreen settings:

```
<?xml version="1.0" encoding="utf-8"?>
<LinearLayout xmlns:android="http://schemas.android.com/apk/res/android"
    android:layout_width="match_parent"
    android:layout_height="match_parent"
    android:orientation="vertical">

    <TextView
        android:id="@+id/setupMessage"
        android:layout_width="match_parent"
        android:layout_height="wrap_content"
        android:text="@string/setup_message"
        android:textAppearance="?android:attr/textAppearanceMedium"
        android:visibility="gone"/>

    <Button
        android:id="@+id/setup"
        android:layout_width="match_parent"
        android:layout_height="wrap_content"
        android:onClick="showSettings"
        android:text="@string/visit_settings"
        android:visibility="gone"/>

    <View
        android:id="@+id/divider"
        android:layout_width="match_parent"
        android:layout_height="2dip"
        android:layout_marginBottom="4dip"
        android:layout_marginTop="4dip"
        android:background="#FF000000"
        android:visibility="gone"/>

    <Switch
        android:id="@+id/camera"
        android:layout_width="match_parent"
        android:layout_height="wrap_content"
        android:text="@string/allow_camera"/>

    <Switch
        android:id="@+id/widgets"
        android:layout_width="match_parent"
        android:layout_height="wrap_content"
        android:layout_marginTop="4dip"
        android:text="@string/allow_widgets"/>
```

```
</LinearLayout>
```

In `onCreate()` of our activity (`MainActivity`), we request a `DevicePolicyManager`, set up a `ComponentName` identifying our `DeviceAdminReceiver` implementation (`LockscreenAdminReceiver`), and hook up the activity to know about changes in the state of the Switch widgets:

```
@Override
protected void onCreate(Bundle savedInstanceState) {
    super.onCreate(savedInstanceState);
    setContentView(R.layout.activity_main);

    mgr=(DevicePolicyManager) getSystemService(DEVICE_POLICY_SERVICE);
    cn=new ComponentName(this, LockscreenAdminReceiver.class);

    camera=(CompoundButton) findViewById(R.id.camera);
    camera.setOnCheckedChangeListener(this);

    widgets=(CompoundButton) findViewById(R.id.widgets);
    widgets.setOnCheckedChangeListener(this);
}
```

In `onResume()`, we check to see if our `DeviceAdminReceiver` is active — in other words, whether the user has set us up as being a device administrator or not:

```
@Override
public void onResume() {
    super.onResume();

    if (mgr.isAdminActive(cn)) {
        toggleWidgets(true);

        int status=mgr.getKeyguardDisabledFeatures(cn);

        camera.setChecked(!((status &
DevicePolicyManager.KEYGUARD_DISABLE_SECURE_CAMERA) ==
DevicePolicyManager.KEYGUARD_DISABLE_SECURE_CAMERA));
        widgets.setChecked(!((status &
DevicePolicyManager.KEYGUARD_DISABLE_WIDGETS_ALL) ==
DevicePolicyManager.KEYGUARD_DISABLE_WIDGETS_ALL));
    }
    else {
        toggleWidgets(false);
    }
}
```

We toggle the visibility and enabled settings of our widgets based upon whether we are a device administrator or not, in a `toggleWidgets()` private method:

## DEVICE ADMINISTRATION

---

```
private void toggleWidgets(boolean enable) {
    int visibility=(enable ? View.GONE : View.VISIBLE);

    camera.setEnabled(enable);
    widgets.setEnabled(enable);

    findViewById(R.id.divider).setVisibility(visibility);
    findViewById(R.id.setup).setVisibility(visibility);
    findViewById(R.id.setupMessage).setVisibility(visibility);
}
```

onResume() also sets the state of our Switch widgets based upon the current state of the keyguard features, by calling getKeyguardDisabledFeatures() on the DevicePolicyManager. This returns a bit set of which features are disabled, with DevicePolicyManager.KEYGUARD\_DISABLE\_SECURE\_CAMERA and/or DevicePolicyManager.KEYGUARD\_DISABLE\_WIDGETS\_ALL possibly being set.

At the outset, after being installed, we will not be a device administrator, so the Switch widgets will be disabled and the Button will be visible. We simply send the user to the security screen in the Settings app if they click that button:

```
public void showSettings(View v) {
    startActivity(new Intent(Settings.ACTION_SECURITY_SETTINGS));
}
```

When the user toggles a Switch, our activity will be called with onCheckedChanged(). There, we need to call setKeyguardDisabledFeatures() with a new bit set, toggling on or off a bit based on the user's chosen values in the UI:

```
@Override
public void onCheckedChanged(CompoundButton buttonView,
                             boolean isChecked) {
    int status=mgr.getKeyguardDisabledFeatures(cn);

    if (buttonView == camera) {
        if (isChecked) {
            mgr.setKeyguardDisabledFeatures(cn, status
                & ~DevicePolicyManager.KEYGUARD_DISABLE_SECURE_CAMERA);
        }
        else {
            mgr.setKeyguardDisabledFeatures(cn, status
                | DevicePolicyManager.KEYGUARD_DISABLE_SECURE_CAMERA);
        }
    }
    else {
        if (isChecked) {
            mgr.setKeyguardDisabledFeatures(cn, status
                & ~DevicePolicyManager.KEYGUARD_DISABLE_WIDGETS_ALL);
        }
    }
}
```

```
else {
    mgr.setKeyguardDisabledFeatures(cn, status
        | DevicePolicyManager.KEYGUARD_DISABLE_WIDGETS_ALL);
}
}
```

Note that we have the Switch widgets set up for positive statements (e.g., “enable the camera”), while the bit set uses negative statements (e.g., “disable the camera”). That makes toggling the bit set a “bit” more complicated, to ensure that we are applying the user’s choices correctly.

## Mandating Quality of Security

You can call various setters on `DevicePolicyManager` to dictate your minimum requirements for the password that the user uses to get past the lock screen. Examples include:

- `setPasswordMinimumLength()`
- `setPasswordQuality()` (with an integer flag describing the type of “quality” you seek, such as `PASSWORD_QUALITY_NUMERIC` if a PIN is OK, or `PASSWORD_QUALITY_COMPLEX` if you require mixed case and numbers and such)
- `setPasswordMinimumLowerCase()` (indicating how many lowercase letters are required at minimum in the user’s password)

All of these require the `<limit-password>` policy be requested in the metadata.

Then, you can call `isActivePasswordSufficient()` to determine if the current password meets your requirements. If it does not, you might elect to disable certain functionality. Or, if you requested the `<reset-password>` policy in the metadata, you can call `resetPassword()` to force the user to come up with a password meeting your requirements.

You can also call `getStorageEncryptionStatus()` on `DevicePolicyManager` to find out whether full-disk encryption is active, inactive, or unavailable on this particular device. If it is inactive, and you requested the `<encrypted-storage>` policy in your metadata, you can call `setStorageEncryption()` to demand it, and start the encryption process via starting the `ACTION_START_ENCRYPTION` activity.



### Getting Along with Others

Bear in mind that you might not be the only device administrator on any given device. If there are multiple administrators, the most secure requirements are in force. So, for example, if Admin A requests a minimum password length of 7, and Admin B requests a minimum password length of 10, the user will have to supply a password that is at least 10 characters long, to meet both device administrators' requirements.

This also means that certain requests you make may fail. For example, if you decide to say that you do *not* need encryption (`setStorageEncryption()` with a value of `false`), if something *else* needs encryption, the user will still need to encrypt their device.

# PowerManager and WakeLocks

---

There are going to be times when you want the device to keep running, even though it ordinarily would go into a sleep mode, with the CPU powered down and the screen turned off. Sometimes, that will be based upon user interactions, or the lack thereof, such as keeping the screen on while playing back a video. Sometimes, that will be to allow background scheduled work to run to completion, as was introduced in the chapter on `AlarmManager`.

This chapter looks a bit more at the details of this sort of power management, including coverage of how `AlarmManager` works.

## Prerequisites

Understanding this chapter requires that you have read the core chapters, particularly [the chapter on `AlarmManager`](#).

## Keeping the Screen On, UI-Style

If your objective is to keep the screen (and CPU) on while your activity is in the foreground, the simplest solution is to add `android:keepScreenOn="true"` to something in the activity's layout. So long as that widget or container is visible, the screen will stay on.

If you wish to do this conditionally, `setKeepScreenOn()` allows you to toggle this setting at runtime.

Once your activity is no longer in the foreground, or the widget or container is no longer visible, the effect lapses, and screen operation returns to normal.

### The Role of the WakeLock

Most of the time in Android, you are developing code that will run while the user is actually using the device. Activities, for example, only really make sense when the device is fully awake and the user is tapping on the screen or keyboard.

Particularly with scheduled background tasks, though, you need to bear in mind that the device will eventually “go to sleep”. In full sleep mode, the display, main CPU, and keyboard are all powered off, to maximize battery life. Only on a low-level system event, like an incoming phone call, will anything wake up

Another thing that will partially wake up the phone is an Intent raised by the AlarmManager. So long as broadcast receivers are processing that Intent, the AlarmManager ensures the CPU will be running (though the screen and keyboard are still off). Once the broadcast receivers are done, the AlarmManager lets the device go back to sleep.

You can achieve the same effect in your code via a WakeLock.

One of the changes that the core Android team made to the Linux kernel was to introduce the concept of the “wakelock”. In simple terms, a wakelock allows a Linux userland application — such as our Android SDK apps — to control whether or not the CPU can be powered down as part of a sleep mode. While a wakelock is in force, the CPU will remain on and processing instructions from the processes and threads that are on the device.

From the SDK, to access a wakelock, you use a WakeLock object, obtained from the PowerManager system service. When you call `acquire()` on that WakeLock, the CPU will remain on; when you call `release()` on that WakeLock, the CPU can fall back asleep, if there are no other outstanding WakeLocks from SDK apps or the operating system itself.

There are four types of WakeLock objects. All will keep the CPU on. They vary in their effects on the screen (leave it off, have it display with dim backlight, have it display with normal backlight) and any physical keys (ignore or accept). You will pass a flag into `newWakeLock()` on the PowerManager system service to indicate what type of WakeLock you want. The most common is the `PARTIAL_WAKE_LOCK`, which keeps the CPU on but leaves the screen and keyboard off — ideal for periodic background work triggered by an AlarmManager event.

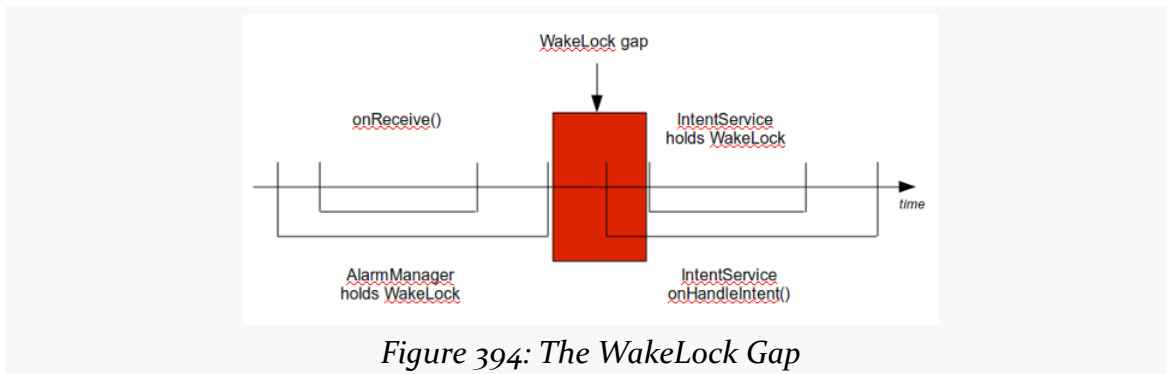
## What WakefulIntentService Does

For a `_WAKEUP` alarm, the `AlarmManager` will arrange for the device to stay awake, via a `WakeLock`, for as long as the `BroadcastReceiver`'s `onReceive()` method is executing. For some situations, that may be all that is needed. However, `onReceive()` is called on the main application thread, and Android will kill off the receiver if it takes too long.

Your natural inclination in this case is to have the `BroadcastReceiver` arrange for a `Service` to do the long-running work on a background thread, since `BroadcastReceiver` objects should not be starting their own threads. Perhaps you would use an `IntentService`, which packages up this “start a `Service` to do some work in the background” pattern. And, given the preceding section, you might try acquiring a partial `WakeLock` at the beginning of the work and release it at the end of the work, so the CPU will keep running while your `IntentService` does its thing.

This strategy will work... some of the time.

The problem is that there is a gap in `WakeLock` coverage, as depicted in the following diagram:



The `BroadcastReceiver` will call `startService()` to send work to the `IntentService`, but that service will not start up until after `onReceive()` ends. As a result, there is a window of time between the end of `onReceive()` and when your `IntentService` can acquire its own `WakeLock`. During that window, the device might fall back asleep. Sometimes it will, sometimes it will not.

What you need to do, instead, is arrange for overlapping `WakeLock` instances. You need to acquire a `WakeLock` in your `BroadcastReceiver`, during the `onReceive()`

## POWERMANAGER AND WAKELOCKS

---

execution, and hold onto that `WakeLock` until the work is completed by the `IntentService`:

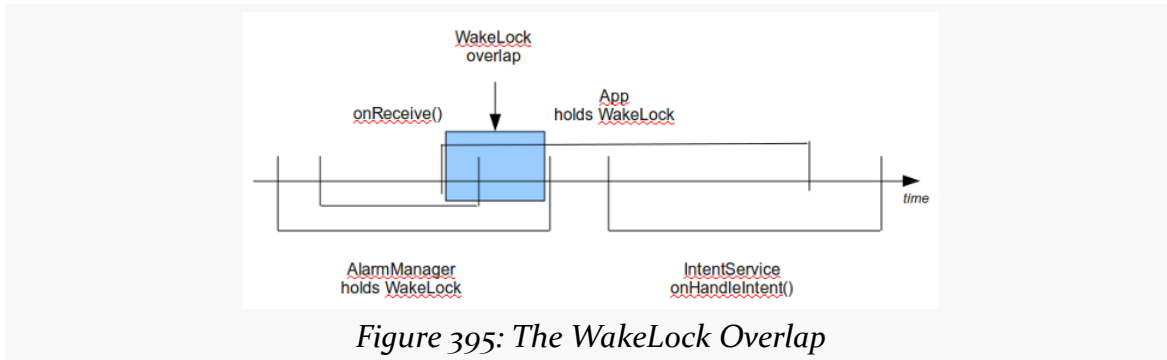


Figure 395: The `WakeLock` Overlap

Then you are assured that the device will stay awake as long as the work remains to be done.

The `WakefulIntentService` recipe described in [its chapter](#) does not have you manage your own `WakeLock`. That is because `WakefulIntentService` handles it for you. One reason why `WakefulIntentService` exists is to manage that `WakeLock`, because `WakeLocks` suffer from one major problem: they are not `Parcelable`, and therefore cannot be passed in an `Intent` extra. Hence, for our `BroadcastReceiver` and our `WakefulIntentService` to use the same `WakeLock`, they have to be shared via a static data member... which is icky. `WakefulIntentService` is designed to hide this icky part from you, so you do not have to worry about it.

`WakefulIntentService` also handles various edge and corner cases, such as:

- What happens if Android elects to get rid of your process due to low memory conditions?
- What happens if your `doWakefulWork()` crashes, so we do not leak the acquired `WakeLock`?
- What if your UI also sends commands to the `WakefulIntentService`, or your processing takes longer than your polling period in `AlarmManager`, so that we have more than one piece of work outstanding at a point in time?

The one requirement related to a `WakeLock` that `WakefulIntentService` imposes upon you is the `WAKE_LOCK` permission. Any code in your process that is directly manipulating `WakeLock` objects needs this permission, even if that code is from a third-party JAR like `WakefulIntentService`.

# Push Notifications with GCM

---

[Google Cloud Messaging](#) – GCM for short — is Google’s **new** framework for asynchronously delivering notifications from the Internet (“cloud”) to Android devices. Rather than the device waking up and polling on a regular basis at the behest of your app, your app can register for notifications and then wait for them to arrive. GCM is engineered with power savings in mind, aiming to minimize the length of time 3G radios are exchanging data.

The proper use of GCM means better battery life for your users. It can also reduce the amount of time your code runs, which helps you stay out of sight of users looking to pounce on background tasks and eradicate them with task killers.

GCM replaces [C2DM](#) (“cloud to device messaging”) as Google’s push framework for Android. While C2DM is still in operation, it is accepting no new developer registrations. New development should use GCM; apps already using C2DM should plan to cut over to GCM as soon as is practical.

## Prerequisites

Understanding this chapter requires that you have read the chapters on:

- [broadcast Intents](#)
- [service theory](#)

## The Precursor: C2DM

C2DM debuted in 2010 as a way for apps to receive “push” messages: messages sent to it from “the cloud” by the app developer’s server. It quickly became popular, for

everything from triggering near-real-time data synchronization (e.g., Remember the Milk to-do list updates) to lightweight coordination between multiple players in a game.

However, C2DM was a Google Labs product and in perpetual beta form. When Google Labs was shut down, C2DM was in limbo: not canceled, but not converted into an actual product. Most likely, that was because while they knew the concept was sound, they wanted to tweak the implementation and APIs and were not ready with its replacement just yet.

### The Replacement: GCM

GCM replaced C2DM in 2012, with C2DM moving into a deprecated state, continuing to function but accepting no new applications.

GCM follows the same basic structure as C2DM, with the app registering for messages, and the developer's server sending messages to the app via a Google-supplied Web service interface. Hence, apps written to use C2DM should migrate over to GCM without significant architectural changes.

GCM raises the 1KB limit for the message to 4KB. It also simplifies the server side, by replacing a fairly clunky authentication model with a "Simple API Key" and lifting quotas that had hamstrung popular C2DM-enabled apps. Also, if the same message needs to be delivered to multiple devices, GCM can send to up to 1,000 at a time, whereas C2DM was limited to a one-device-per-Web-service-call model.

As a result, GCM provides the benefits of C2DM without some of the annoying limitations. That being said, GCM is not perfect, and we will examine some of the limitation that remain [later in this chapter](#).

### The Pieces of Push

There are many components that you will need to work with in order to enable GCM in your app, both inside the app itself and in your app server (or other off-app environment) where you are trying to push messages to the app.

### API Key

Since GCM is a Google service, you need a Google API key to use it. To get one of these, visit <https://code.google.com/apis/console>, while logged in with your chosen Google account. Click on “Create project...” to create a new project. Your browser URL will change to something like `https://code.google.com/apis/console/?pli=1#project:NNNNNNNNNNNN:services`, where NNNNNNNNNNNN is some number. Make note of this number, as it is your GCM sender ID.

Then, scroll down in the list of services and click the fake “switch” icon next to Google Cloud Messaging for Android. That will bring up a terms of service page, which you will dutifully provide to your chosen attorney or other legal adviser for review. You will not proceed further until you have received legal clearance to do so. Meanwhile, we will wait.

.  
. .  
. .  
. .

OK, now that you are sure you wish to use this service, go ahead and click the “I agree to these terms” checkbox, then click the Accept button. You will now see that “switch” for Google Cloud Messaging for Android be set to “ON”.

In the navigation bar on the left side of the page, you should see an “API Access” link. Click that, then click on the “Create new Server key...” button on the subsequent page. If you wish to restrict the IP addresses that can use this key (for security reasons), supply the public IP subnets you wish to use in the supplied text area. Then click the Create button. That will take you back to the “API Access” page, where you will see your API key.

Note that if you think that your key has been compromised, you can click the “Generate new key...” link in the box for your API key. This will generate a fresh API key, with the old key still working for 24 hours, giving you time to switch to using the new key on your server(s). Or, click “Delete key...”, and your key will be immediately deleted, after which you can set up a fresh key.



## PUSH NOTIFICATIONS WITH GCM

To confirm that your API key works, if you have [the curl program](#), the `gcmtest` script in the [Push/GCMClient](#) sample project will help you confirm that the API key works. Run `gcmtest`, with your API key as a parameter. If you get something like the following, your API key is good:

```
{ "multicast_id":7932441338082226994,
  "success":0,
  "failure":1,
  "canonical_ids":0,
  "results":[{"error":"InvalidRegistration"}]}
```

If, instead, you get an HTTP 401 error, then your API is flawed in some way.

### GCM Client JAR

To work with GCM from your Android application, you will want the GCM client JAR. This is available from your SDK Manager as “Google Cloud Messaging for Android Library”, in the Extras area:

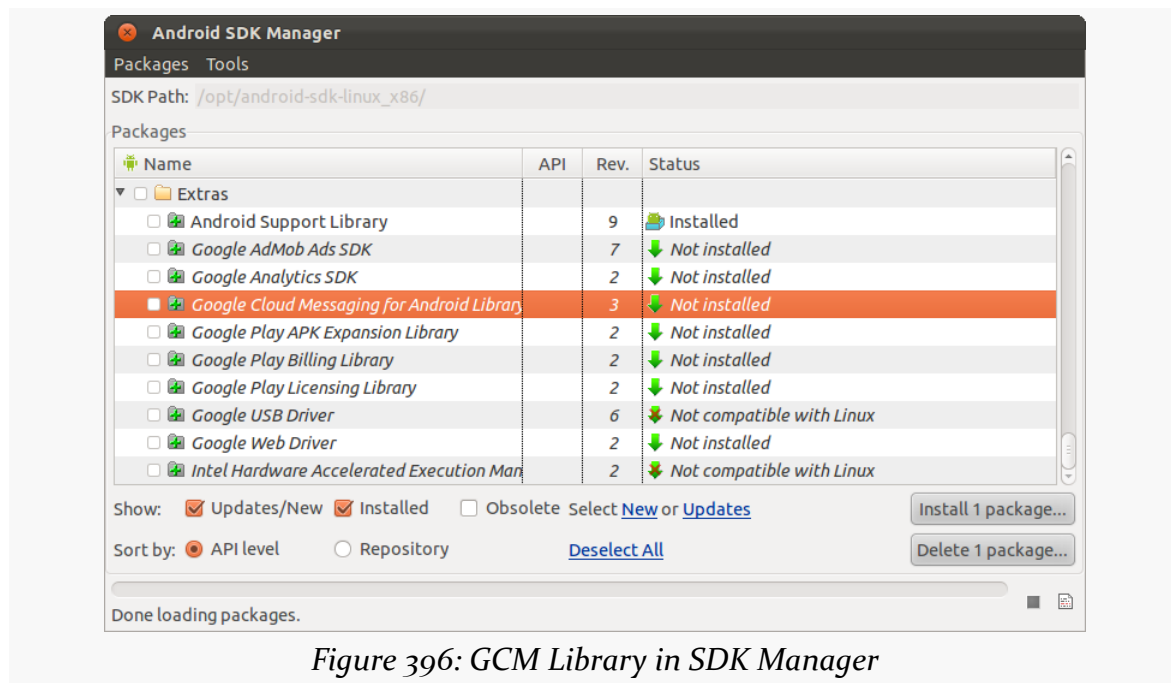


Figure 396: GCM Library in SDK Manager

Wherever you have your SDK installed, you will find an `extras/google/gcm/gcm-client/dist/` directory, with a `gcm.jar` file in it. You will need to add that to the `libs/` directory of your project, following the notes covered in [the chapter on adding third-party libraries](#).

### Android App

Beyond the aforementioned library, your application using GCM has several requirements that you must meet, outlined in the following sections.

#### Custom Permission

Your application needs to define a custom permission, whose name is your application's package name with `.permission.C2D_MESSAGE` appended to the end. So, for an app residing in the `com.commonware.android.gcm.client` package, the permission to be defined is:

```
<permission
  android:name="com.commonware.android.gcm.client.permission.C2D_MESSAGE"
  android:protectionLevel="signature"/>
```

You also need the corresponding `<uses-permission>` element:

```
<uses-permission
  android:name="com.commonware.android.gcm.client.permission.C2D_MESSAGE"/>
```

This is all rather odd, considering that nothing else in your project seems to refer to this permission. Also, it is not required if you are only supporting API Level 16 and higher (i.e., your `android:minSdkVersion` is set to at least 16).

#### Additional Permissions

There are several other permissions that you need to hold:

```
<uses-permission android:name="com.google.android.c2dm.permission.RECEIVE"/>
<uses-permission android:name="android.permission.INTERNET"/>
<uses-permission android:name="android.permission.GET_ACCOUNTS"/>
<uses-permission android:name="android.permission.WAKE_LOCK"/>
```

The first allows you to receive messages from GCM, though it uses `c2dm` in the name for backwards compatibility with C2DM. The second allows your GCM library to access the Internet, while the third allows your GCM library to access information about your Google account. The last permission allows the GCM library to hold a `WakeLock` to keep the device awake while it is downloading messages — you will learn more about `WakeLock` in [the chapter on PowerManager](#).

### Your Registration Code

Your app will need to use static methods on the `GCMRegistrar` class supplied by the GCM client library to register with GCM and create a registration ID. That ID, in turn, will be used by your server code to uniquely identify a copy of your app running on a specific device. Messages sent by your server to that registration ID will be delivered to your app on that device.

There are four methods on `GCMRegistrar` of note in this process:

1. `checkDevice()` will help to make sure the device is ready for using GCM, including whether or not it has the Google Services Framework.
2. `checkManifest()`, in theory, should examine your app's manifest to make sure that everything is set up properly. This is not required in your production code, but can be used to help diagnose issues at development time. In practice, `checkManifest()` might catch some issues, but it most certainly [does not catch them all](#).
3. `getRegistrationId()` returns the registration ID for your app, or a zero-length string if you are not yet registered.
4. `register()` takes the sender ID you obtained [earlier in this chapter](#) and registers your app to be able to receive messages sent by that sender. You would only need to call this if `getRegistrationId()` returns the empty string.

You can place this code wherever makes sense, such as your launcher activity.

### GCMBroadcastReceiver

You need to have an entry in your manifest for a GCM-supplied `BroadcastReceiver` that gets control when messages are received by the Google Services Framework:

```
<receiver
  android:name="com.google.android.gcm.GCMBroadcastReceiver"
  android:permission="com.google.android.c2dm.permission.SEND">
  <intent-filter>
    <action android:name="com.google.android.c2dm.intent.RECEIVE"/>
    <action android:name="com.google.android.c2dm.intent.REGISTRATION"/>

    <category android:name="com.commonware.android.gcm.client"/>
  </intent-filter>
</receiver>
```

## PUSH NOTIFICATIONS WITH GCM

---

This is entirely boilerplate, with the exception of the `<category>` element in the `<intent-filter>`. The name of the category must be the name of your application's package (in this case, `com.commonware.android.gcm.client`).

Since the implementation of `com.google.android.gcm.GCMBroadcastReceiver` is supplied by the GCM client library, you do not need any Java code associated with this manifest entry.

### Your GCMIntentService

Finally, your app will need its own custom subclass of `com.google.android.gcm.GCMBaseIntentService`. This class *must* be named `GCMIntentService` and reside in your application's package, if you are using the stock implementation of `GCMBroadcastReceiver` as described in the previous section.

This `IntentService` will get control when messages arrive for your app, or other GCM-related events occur. You will override individual methods for these different events. There are four such methods you *must* override, as `GCMBaseIntentService` is an abstract class and these methods are declared as abstract:

1. `onRegistered()` will be called when a registration request that you kicked off with a call to `register()` on `GCMRegistrar` has completed. You are handed the registration ID. You will need to do something, on your own, to deliver this value to your server (e.g., call a Web service).
2. `onUnregistered()` will be called sometime after you call `unregister()` on `GCMRegistrar` to indicate that your app no longer wishes to receive GCM messages from your server. You might do this as part of allowing the user to delete their account in your app. You are passed the registration ID that is now obsolete, and you can pass that to your server environment... though your server will also find out about unregistered clients by another means.
3. `onMessage()` will be called with a message that your server sent to your app. The message arrives in the form of an `Intent` object. The key/value pairs that your server declares to be the message will arrive as `Intent` extras on that `Intent`.
4. `onError()` will be called if there is some unrecoverable error. You are passed a `String` that is the error message, that you can log somewhere, or put in a `Notification`, or whatever makes sense.

Optionally, you can override `onRecoverableError()`, which will be called if there is some problem that GCM will automatically handle (e.g., network connectivity)

problem). If you override `onRecoverableError()` and return `false`, that will indicate that GCM should *not* keep retrying the operation.

One undocumented feature of `GCMBaseIntentService` is that it maintains a `WakeLock`, similar to the behavior of the `WakefulIntentService` described in [the chapter on AlarmManager](#). The device should not fall asleep while your work is going on. However:

- This is an undocumented feature, and therefore may change in future versions of the GCM client JAR
- There are [some issues](#) with the GCM implementation of its `WakeLock` handling

### Your Server (a.k.a., the Thing Doing the Pushing)

Something, outside of your app, is going to be pushing messages to devices that are running your app and registered for such messages. In the GCM documentation, this is referred to as your “server”.

Technically speaking, this does not have to be a “server”: something running constantly with some sort of inbound socket connection. To actually push messages, you will need Internet access to Google’s servers, but whether you push the message from a true server, or a desktop app, or a command-line program, is really up to you.

GCM supplies a “server” JAR file that handles the REST protocol and gives you Java objects for building and sending the message. This JAR file has an undocumented dependency on the `json-simple` library. If your desired “server” environment is not in Java, you could reimplement the REST protocol library in some other programming language (e.g., Ruby) if desired. The GCM documentation [describes the request and response formats](#) that your library would need to handle.

For simplicity, this chapter will use a crude command-line Java client, based upon the GCM “server” JAR.

### Google’s Server and the Google Services Framework

One piece of the environment that you do not control is Google’s GCM server farm. When you send a message to the clients, you do not do so directly, but rather you send your message to Google by means of a REST-style Web service. Google, in turn, forwards your messages along to the clients. Google supplies a JAR file that you can

## PUSH NOTIFICATIONS WITH GCM

---

use on your server, or you could implement the REST-style interface in other ways, using anything from `curl` to a Ruby gem, if you so choose.

On the device, your code is working with the Google Services Framework by means of the supplied client library. The Google Services Framework also handles things like letting the device know about app updates.

Each device maintains a long-running persistent socket connection to Google's GCM server farm. When your server sends a message, it passes the message to Google's GCM server farm, which finds the connection to the client(s) and sends along the message. If a client is unavailable for some reason, the GCM servers will cache your message for a period of time in hopes of being able to deliver it shortly.

The fact that Google servers have your message for any length of time introduces some privacy and security issues, which we will examine [later in this chapter](#).

## A Simple Push

With all this in mind, we can walk through an example of implementing GCM. This sample comes in two parts:

1. An app that runs on the Android device that uses GCM
2. A command-line Java app that can send messages via GCM, useful for light testing

## The Client

Our client-side Android app can be found in the [Push/GCMClient](#) sample project.

Our manifest has all the things outlined earlier in this chapter:

- the custom permission
- all those `<uses-permission>` elements
- a `<receiver>` element for the `com.google.android.gcm.GCMBroadcastReceiver`
- our `GCMIntentService`
- our activity, named `MainActivity`

```
<manifest xmlns:android="http://schemas.android.com/apk/res/android"
  package="com.commonware.android.gcm.client"
  android:versionCode="1"
  android:versionName="1.0">
```

## PUSH NOTIFICATIONS WITH GCM

---

```
<uses-sdk
  android:minSdkVersion="8"
  android:targetSdkVersion="15"/>

<supports-screens
  android:largeScreens="true"
  android:normalScreens="true"
  android:smallScreens="true"
  android:xlargeScreens="true"/>

<permission
  android:name="com.commonware.android.gcm.client.permission.C2D_MESSAGE"
  android:protectionLevel="signature"/>

<uses-permission
  android:name="com.commonware.android.gcm.client.permission.C2D_MESSAGE"/>
<uses-permission android:name="com.google.android.c2dm.permission.RECEIVE"/>
<uses-permission android:name="android.permission.INTERNET"/>
<uses-permission android:name="android.permission.GET_ACCOUNTS"/>
<uses-permission android:name="android.permission.WAKE_LOCK"/>

<application
  android:icon="@drawable/ic_launcher"
  android:label="@string/app_name"
  android:theme="@style/AppTheme">
  <activity android:name=".MainActivity">
    <intent-filter>
      <action android:name="android.intent.action.MAIN"/>

      <category android:name="android.intent.category.LAUNCHER"/>
    </intent-filter>
  </activity>

  <receiver
    android:name="com.google.android.gcm.GCMBroadcastReceiver"
    android:permission="com.google.android.c2dm.permission.SEND">
    <intent-filter>
      <action android:name="com.google.android.c2dm.intent.RECEIVE"/>
      <action android:name="com.google.android.c2dm.intent.REGISTRATION"/>

      <category android:name="com.commonware.android.gcm.client"/>
    </intent-filter>
  </receiver>

  <service android:name=".GCMIntentService"/>
</application>

</manifest>
```

In `onCreate()` of the activity, we make our calls to `checkDevice()` and `checkManifest()`, the latter only when our app is built in debug mode:

## PUSH NOTIFICATIONS WITH GCM

---

```
@Override
public void onCreate(Bundle savedInstanceState) {
    super.onCreate(savedInstanceState);
    setContentView(R.layout.activity_main);

    GCMRegistrar.checkDevice(this);

    if (BuildConfig.DEBUG) {
        GCMRegistrar.checkManifest(this);
    }
}
```

In a production app, the `checkDevice()` call should be wrapped in a `try/catch` block, to handle any `RuntimeException` it throws due to device incompatibility, with you doing something to alert the user of the problem. Here, if the device is incompatible, it will simply crash the app.

Our UI consists of one really big button, tied to an `onClick()` method:

```
public void onClick(View v) {
    final String regId=GCMRegistrar.getRegistrationId(this);

    if (regId.length() == 0) {
        GCMRegistrar.register(this, SENDER_ID);
    }
    else {
        Log.d(getClass().getSimpleName(), "Existing registration: "
            + regId);
        Toast.makeText(this, regId, Toast.LENGTH_LONG).show();
    }
}
```

Here, we use `getRegistrationId()` to see if we are already registered. This should return a zero-length string if we are not, so in that case, we use `register()` to go register our device and app for messages. The `SENDER_ID` used in the `register()` call is a static data member – **you will need to change the value of this to be your own `SENDER_ID`** for you to be able to send messages to this app.

Our `GCMIntentService`, inheriting from the supplied `GCMBaseIntentService`, mostly logs messages to `LogCat` for all events:

```
package com.commonware.android.gcm.client;

import android.content.Context;
import android.content.Intent;
import android.os.Bundle;
import android.util.Log;
import android.widget.Toast;
import com.google.android.gcm.GCMBaseIntentService;
```



## PUSH NOTIFICATIONS WITH GCM

---

```
public class GCMIntentService extends GCMBaseIntentService {
    public GCMIntentService() {
        super(MainActivity.SENDER_ID);
    }

    @Override
    protected void onRegistered(Context ctxt, String regId) {
        Log.d(getClass().getSimpleName(), "onRegistered: " + regId);
        Toast.makeText(this, regId, Toast.LENGTH_LONG).show();
    }

    @Override
    protected void onUnregistered(Context ctxt, String regId) {
        Log.d(getClass().getSimpleName(), "onUnregistered: " + regId);
    }

    @Override
    protected void onMessage(Context ctxt, Intent message) {
        Bundle extras=message.getExtras();

        for (String key : extras.keySet()) {
            Log.d(getClass().getSimpleName(),
                String.format("onMessage: %s=%s", key,
                    extras.getString(key)));
        }
    }

    @Override
    protected void onError(Context ctxt, String errorMsg) {
        Log.d(getClass().getSimpleName(), "onError: " + errorMsg);
    }

    @Override
    protected boolean onRecoverableError(Context ctxt, String errorMsg) {
        Log.d(getClass().getSimpleName(), "onRecoverableError: " + errorMsg);

        return(true);
    }
}
```

We do raise a Toast to show the registration ID if we registered the app. And, the `onMessage()` implementation iterates over the keys of the Intent extras and logs each one individually, so you can see the discrete pieces of your message payload. Also note that `onRecoverableError()` returns true, indicating that Android is welcome to retry the operation as it sees fit.

Also note that we need a zero-argument public constructor that chains to the superclass and supplies our sender ID. Alternatively, we could have skipped the constructor and overridden `getSenderIds()` to supply a sender ID to the superclass

## PUSH NOTIFICATIONS WITH GCM

---

— this would be preferable if the sender ID might change during the lifetime of the service.

This client assumes that the registration ID is transferred to our server by some means outside of the app itself, possibly involving elves or carrier pigeons or something. For your own testing purposes using the GCMCommand “server” project, you can get the registration ID out of LogCat.

If, however, this client really were to send the registration ID to the server, perhaps through a Web service, it could call `setRegisteredOnServer()` on `GCMRegistrar()` to note that we successfully completed this step. Later on, we could call `isRegisteredOnServer()` to see if we transferred the registration ID or not, so perhaps we can try again if needed.

### The “Server”

Our command-line Java app for sending messages can be found in the [Push/GCMCommand](#) sample project. Note that this is a plain Java project, not an Android project, as this is designed to run on your desktop or server, not on your device. Also note that four total JARs are needed to run this app:

1. The project’s own JAR
2. `gcm-server.jar`, from the GCM portion of your SDK’s `extras/` area
3. `json-simple-1.1.jar`, a compatible implementation of the `json-simple` library used by the GCM JAR
4. `commons-cli-1.2.jar`, which is used for command-line argument processing for this app

From a GCM standpoint, the GCM class in this sample project has a static `sendMessage()` method that does the work of sending a message to one or more devices:

```
private static void sendMessage(String apiKey, List<String> devices,
                               Properties data) throws Exception {
    Sender sender=new Sender(apiKey);
    Message.Builder builder=new Message.Builder();

    for (Object o : data.keySet()) {
        String key=o.toString();

        builder.addData(key, data.getProperty(key));
    }

    MulticastResult mcResult=sender.send(builder.build(), devices, 5);
}
```

## PUSH NOTIFICATIONS WITH GCM

---

```
for (int i=0; i < mcResult.getTotal(); i++) {
    Result result=mcResult.getResults().get(i);

    if (result.getMessageId() != null) {
        String canonicalRegId=result.getCanonicalRegistrationId();

        if (canonicalRegId != null) {
            System.err.println(String.format("%s canonical ID = %s",
                devices.get(i),
                canonicalRegId));
        }
        else {
            System.out.println(String.format("%s success", devices.get(i)));
        }
    }
    else {
        String error=result.getErrorCodeName();

        if (Constants.ERROR_NOT_REGISTERED.equals(error)) {
            System.err.println(String.format("%s is unregistered",
                devices.get(i)));
        }
        else if (error != null) {
            System.err.println(String.format("%s error = %s",
                devices.get(i), error));
        }
    }
}
}
```

The pieces of information we need to send a message are:

- Our GCM API key
- A list of the device registration IDs to which GCM should deliver our message
- The key/value pairs of data that form our message payload

The [Apache Commons CLI](#) logic in this class' static main() method will extract these values from the command line and give them to sendMessage() for processing.

To send the message, sendMessage() first creates a GCM Sender object, supplying our API key to the constructor. Then, it creates a Message.Builder, which is a builder for constructing a GCM message to be sent by that Sender. We use addData() on the builder to attach our key/value pairs, extracted from the java.util.Properties object that Apache Commons CLI used to give us the key/value pairs specified on the command line.

## PUSH NOTIFICATIONS WITH GCM

---

Actually sending the message then is a matter of calling `send()` on the `Sender`, supplying the `Message` built by the builder, the list of device registration IDs, and the number of retries in case there are issues in delivering the message (e.g., the server farm is swamped). We get back a `MulticastResult` object, containing details of what happened for each device in our list of devices.

`MulticastResult` is really a collection of individual `Result` objects, one per device. Each `Result` will tell us what happened, with four major possibilities:

1. Our request to enqueue the message succeeded, and the device should receive it momentarily if it is online and connected to Google.
2. Our request succeeded, but Google would like us to use a different registration ID in the future. We are given the revised ID via `getCanonicalRegistrationId()`. In a production app, we would have some sort of database of registered devices; we would replace the old registration ID with the new canonical one in that database when this result occurs.
3. Our request failed, because the device is no longer registered (e.g., the app was uninstalled). In a production app, we should remove this device from our database.
4. Our request failed for some other reason (e.g., our request was attacked by ninjas). We get an error message as a string indicating the reason for the failure; a production app would log this somewhere.

In the case of this sample command-line client, these are simply logged to `stdout` or `stderr`.

The sample project has a Linux shell script that wraps up building Java command line:

```
java -cp libs/commons-cli-1.2.jar:libs/gcm-server.jar:libs/
json_simple-1.1.jar:dist/gcm-cmd.jar \
com.commonware.android.gcm.cmd.GCM "$@"
```

(note: once again, the trailing `\` on the first line indicates that this should be all on one line)

To use the script, switch to the `GCMCommand` directory, run `./gcm`, supplying the following command-line switches:

- `-a` or `--apiKey` with the value of your API key (note: **not** your sender ID!)
- `-d` or `--device` with the value of a device's registration ID (can have one or several of these switches)

---

## PUSH NOTIFICATIONS WITH GCM

---

- `-D` or `--data`, with the `key=value` pair of some data to send to a device (can have one or several of these switches)

For example, this command would send `foo=bar` to a device:

```
./gcm -a your-api-key-here -D foo=bar -d your-device-reg-id-here
```

The results will be printed to standard output, one line per `-d` switch, in the order of the `-d` switches (e.g., first registration ID in the command maps to the first line in the output).

## Message Options and Advanced Features

Most of what you get out of GCM comes just from the code we have implemented so far. However, there are other things you can configure with your message to tailor delivery behavior. These come in the form of special `key/value` pairs added to the message payload itself, serving in the role of metadata. Note that since they elected to blend the metadata in with your data, you cannot yourself have data with the same keys as are used by Google for metadata. And, unfortunately, they did not elect to namespace their keys — even with something as trivial as a leading underscore — to help prevent collisions.

### Collapse Keys

Google is not considering GCM to be a guaranteed store-and-forward queue system. In particular, Google reserves the right to try to coalesce messages, in part to reduce storage demands, but also so as not to flood the device when a connection is re-established.

Key to this is the `collapse_key` key on the message request. If a device is unavailable, and during that time you send two or more messages with the same `collapse_key`, the GCM servers may elect to only send one of those messages — typically the last one, though not necessarily. You can use this to your advantage, to minimize processing you need to do on the client. For example, if your use of GCM is to alert your custom email application that “you’ve got mail”, you can use a consistent `collapse_key` with messages telling the client how many unread emails are in their inbox. That can be used by the client to update a `Notification` and, eventually, cajole the user into actually reading her mail. In this case, you do not need the device to receive two messages in a short timespan to raise this `Notification`, so collapsing those into a single message is good for everyone.

## PUSH NOTIFICATIONS WITH GCM

---

For example, using the `gcm` script, `-D collapse_key=inbox` would set the `collapse_key` of the request to `inbox`, coalescing it with any other messages that you have sent to this device, with the same `collapse_key`, that have not yet been delivered.

A related optional parameter you can include in your messages is `delay_while_idle`. If you specify this key with a value of `true`, that will indicate to the GCM servers that, while you want the message to be delivered, it is not important enough to wake up the device. GCM will hold onto the message (or the last one if several are sent with the same `collapse_key`), but it will not push it to the device until it knows the device is awake (perhaps due to another GCM message for that device lacking this parameter). You can think of this as being akin to choosing an `AlarmManager` alarm type lacking the `_WAKEUP` suffix. The goal is to minimize battery consumption.

Note that if you eschew `collapse_key`, and you send a lot of messages without the device receiving them (e.g., it is powered down), you will run into problems. Right now, there is a limit of 100 queued messages. If you hit that limit, all queued messages are dumped, and the device will be sent “a special message indicating that the limit was reached”. It will be up to your app to handle this scenario, typically by assuming that your data from the server is very stale and needs to be completely reloaded. Note that the structure of this “special message” is, alas, undocumented.

The `Message.Builder` in the GCM server JAR has dedicated `collapseKey()` and `delayWhileIdle()` methods to set these values.

### Time-To-Live

If you are using `collapse_key`, you can also control how long the message will remain cached on the server, via a `time_to_live` value specified in seconds. The default is four weeks. But if you know the message is useless after a shorter period of time (e.g., after some real-world event has occurred), specifying a `time_to_live` can purge this message and prevent the app on the device from displaying something useless to the user.

The `Message.Builder` in the GCM server JAR has a dedicated `timeToLive()` method to set this value.

### Re-Registration

In an ideal world, we would have our apps generate a registration ID once and be done with it for any given device. However, there are scenarios in which our app will need to re-register and supply a revised registration ID to the server:

- if the user uninstalls and reinstalls our app
- if the user taps the “Clear Data” button in the Settings app, to wipe out our app’s internal storage (where the registration ID is held)
- when we upgrade our app (i.e., ship an app with a different `android:versionCode` in the manifest)

While the first two might not be terribly surprising, the latter one might be. The source code for `GCMRegistrar`, as of the time of this writing, has the following comment in `getRegistrationId()`:

```
// check if app was updated; if so, it must clear registration id to  
// avoid a race condition if GCM sends a message
```

`GCMRegistrar` keeps our app’s `versionCode` in the same custom `SharedPreferences` that it uses for the registration ID. Whenever registration occurs, it saves our `versionCode`. But, the next time we go to retrieve the registration ID, if our `versionCode` is different than the one that was saved, GCM clears our saved registration ID, forcing us to get a new one.

Since this behavior seems to be undocumented, it is possible that in the future they will find some other solution and perhaps reduce the number of re-registrations that may be required.

### Considering Encryption

GCM uses encryption over the air. This includes both your server communicating with Google’s server via HTTPS and Google’s server communicating with your device.

However, there is still one party who has access to that data besides you and your user: Google. Google also knows the identity of your users, since their devices are the ones registering for GCM messages, and therefore those messages can be traced back to their devices. The fact that Android 4.1 and beyond eschew the need for a Google account to use GCM will help privacy somewhat.

## PUSH NOTIFICATIONS WITH GCM

---

Here are two ways of dealing with this, beyond ignoring the issue:

1. Encrypt your payload. Since GCM is expecting key/value pairs, that means that you would either encrypt each value (and their keys, if the keys might somehow be leaking data), or creating your own encrypted payload, encoding it in Base64, and using that as a single value in your GCM message. This, of course, implies that the client will be capable of decrypting your messages.
2. Have your payload be a URL pointing to some other resource that your client can access but not Google (at least not readily). In this mode, you are using GCM purely as a “tickle” to tell the client to go download some data via another secured means earlier than it might ordinarily do such a download (e.g., via a daily poll).

## Issues with GCM

GCM, of course, is not perfect. As with its C2DM predecessor, it has a variety of issues, many of which will not be a problem for you, though some might be more troublesome.

### Requires Google Services Framework

GCM only works on devices that have the Google Services Framework. For all intents and purposes, this means it only works on devices that have the Play Store. While most Android devices do have the Play Store, some notable ones do not, including the Kindle Fire.

If you are planning to distribute your app to devices by means other than the Play Store, you will need to consider a fallback plan. You will find out about the issue at runtime by a `RuntimeException` being raised by the call to `checkDevice()` on `GCMRegistrar`. At that point, you will need to switch your app into some GCM-less mode of operation, perhaps falling back to a user-configurable polling system.

### Requires API Level 8

GCM only works on devices with API Level 8 or higher — the point in time when the Google Services Framework was formally established and C2DM was added to the ecosystem.



## PUSH NOTIFICATIONS WITH GCM

---

Since the vast majority of Android devices run API Level 8 or higher, this should only be an issue for developers specifically aiming to support older devices (e.g., still have significant customers for the older app).

### No SLA

Google does not offer a service level agreement (SLA) for GCM. In other words, what they offer is a “best efforts” service, but if they fail to deliver your messages for one reason or another, you have no legal recourse.

For many situations, this is less a legal problem and more of a usage problem. The fact that GCM can fail means that, from time to time, it likely *will* fail. Apps should not rely upon GCM as their sole means of getting data from a server. Instead, use GCM as an optimization, to get data faster than some slow poll (e.g., once every 24 hours) would accomplish. That way, even if GCM hiccups and loses a message or two, the data will still make it down to your users, albeit not as quickly.

Applications that need some sort of guaranteed delivery will need to seek some alternative solution where the provider offers an SLA.

### Not For Peer-to-Peer

You might be tempted to use GCM for peer-to-peer messaging, without a server of your own. In effect, each Android app is its own server, using the same JAR you might use in a Web app inside your Android app to send messages to some other party. For example, you could implement a chat system without having a dedicated chat server.

The danger here is that this would require your API key to be embedded within your Android application. Anyone with that API key is perfectly capable of forging messages from you. The IP address restrictions you could place on that API key are unlikely to help, since your legitimate uses might come from any IP address, not just some single server. Since finding magic strings in APK files is not that difficult for those with the inclination, putting your API key in your APK file is a dangerous move.

### 4K Message Limit

C2DM had a 1K message payload limit. GCM raises that to 4K. This is still relatively small. The theory behind the increase is that it is more likely that everything you

## **PUSH NOTIFICATIONS WITH GCM**

---

need to hand the client would be included in the GCM message versus needing additional network I/O. However, due to the fact that Google has access to GCM messages, you might need additional network I/O for privacy reasons, regardless of message size.



# Push Notifications with C2DM

---

[C2DM](#) — short for “cloud to device messaging” — is Google’s **old** framework for asynchronously delivering notifications from the Internet (“cloud”) to Android devices. Rather than the device waking up and polling on a regular basis at the behest of your app, your app can register for notifications and then wait for them to arrive. C2DM is engineered with power savings in mind, aiming to minimize the length of time 3G radios are exchanging data.

The proper use of C2DM means better battery life for your users. It can also reduce the amount of time your code runs, which helps you stay out of sight of users looking to pounce on background tasks and eradicate them with task killers.

C2DM has been replaced by [Google Cloud Messaging](#) (GCM). New apps should use GCM instead. This chapter remains in place for those developers who have been using C2DM and wish to continue doing so for a little while longer.

Also, note that C2DM is only available on Android 2.2 and higher. And, if you intend to use the Android 2.2 emulator, you will need to register a Google account on the emulator, via the Settings application.

## Prerequisites

Understanding this chapter requires that you have read the chapters on:

- [broadcast Intents](#)
- [service theory](#)

## Pieces of Push

C2DM has a lot of parts that need to connect together to allow your servers to asynchronously deliver messages to your Android applications.

### The Account

You will need a Google account to represent the server from which the messages are delivered. The Android client application will register for messages from this account, and the server will send messages to Google for delivery using this account.

This account can be a pure Google account (e.g., @gmail.com) or one that is set up for your own domain using Google Apps. However, it is probably a good idea to use an account that you will not be using for anything else or likely to need to change. Considering that this account name will be “baked into” your Android application (in simple implementations, anyway), changing it may not be that easy.

You will need to supply this account on the [C2DM signup form](#) before proceeding with your C2DM integration.

### The Android App

Obviously, there is your Android app — without this, having a chapter on C2DM in this book would be rather silly. Your Android application will need at least one new class, some other additional Java code, and some manifest modifications to be able to participate in C2DM.

### Your Server

Something has to send messages to the Android apps by way of Google. This is generally called “the server application”, though technically it does not need to run on a server. Whatever it is, it will have a reason to send data asynchronously to your Android applications, and it will need to have the ability to send HTTP requests to Google’s servers to actually send that data.

### Google’s Server

Your server is not directly communicating with the Android apps. Instead, you send the messages to Google, who queues them up and will deliver them as soon as is

practical. That may be nearly immediately, but it may take some time, particularly depending on how the message is configured and whether the device is on.

### Google's On-Device Code

The reason that Android 2.2 is required is that 2.2 is the first release containing Google's code for managing its side of the C2DM connection. In effect, Google's on-device code maintains an open socket with its servers. Messages, when they arrive at the servers, are delivered over this open socket.

### Google's Client Code

Google has created some client-side code to help you manage your C2DM registrations and messages, handling a lot of the boilerplate logic for you. As of the time of this writing, that code is part of the [chrome2phone sample application](#). Google has indicated that it will be pulling that code out into a separate library, and this chapter demonstrates the use of that code.

## Getting From Here to There

So, how does this all work?

First, your Android application will tell Google's on-device code that it wants to register for messages from your Google account. Using the Google C2DM client code, this is a single call to a static method on a class — under the covers, it packages the information in an Intent and sends it to the Google on-device code.

When the registration occurs, you will be notified by a broadcast Intent, containing a registration ID. Google's C2DM client code will route that to an IntentService, where you can do whatever is necessary. A typical thing to do would be to make a Web service call to your server, supplying the registration ID, so the server knows how to send messages to your application on this device.

At this point, given the registration ID, the server is able to send messages to your app. It will do this by first getting a valid set of authentication credentials — effectively turning the Google account name and password into a long-lived authentication token. Then, your server can do an HTTP POST to the Google C2DM servers, supplying that authentication token, the registration ID of the app, and whatever data should be passed along.

Once Google’s servers receive that POST, your app will receive the message at the next available opportunity. This could be in a matter of seconds. It could be in a matter of days, if the user is traveling and has their phone on “airplane mode”. It could be anywhere in between. And, if the user does not pick up the message within a reasonable period of time, Google may drop the message.

Assuming the message makes it to the device, it will be routed to you via a broadcast Intent, perhaps handled by the same IntentService you set up for registration notices.

Your app can unregister whenever it wishes, to invalidate the registration ID and stop receiving messages.

## Permissions for Push

C2DM uses Android permissions in a somewhat more sophisticated fashion than do most applications. That sophistication will require you to do a few things in your manifest above and beyond the norm.

First, you will need to request the INTERNET permission. Technically, this is only required if you are using the Internet (e.g., a Web service) to send the registration ID to your server. However, that will be a fairly typical pattern.

Next, you will need to request the `com.google.android.c2dm.permission.RECEIVE` permission. This allows your application to receive messages from the C2DM engine that forms the core of Google’s on-device C2DM code.

You also will want to define a custom permission — `C2D_MESSAGE`, prefixed by your application’s package — and declare that you use that permission. This will be used to help prevent other applications from spoofing you with fake C2DM messages.

If you are using the Google C2DM client code, as is shown in the sample project for this chapter, you will also need to request the `WAKE_LOCK` permission, as the C2DM client code uses a `WakeLock` to help ensure that the device stays awake long enough for you to handle incoming messages, much like the `WakefulIntentService` shown [elsewhere in this book](#).

From the [Push/C2DM](#) sample project, here are the permission-related elements from `AndroidManifest.xml` corresponding to the preceding points:

```
<permission
  android:name="com.commonware.android.c2dm.permission.C2D_MESSAGE"
  android:protectionLevel="signature"/>

<uses-permission
android:name="com.commonware.android.c2dm.permission.C2D_MESSAGE"/>
<uses-permission android:name="com.google.android.c2dm.permission.RECEIVE"/>
<uses-permission android:name="android.permission.INTERNET"/>
<uses-permission android:name="android.permission.WAKE_LOCK"/>
```

## Registering an Interest

Now, let's start taking a closer look at some code, to get C2DM going in an application. Again, all source code listings are coming from the Push/C2DM sample project.

In a production application, you would probably register for messages from your server on first run of the app, such as after the user has launched it from the launcher and clicked through any license agreement you might have. For the Push/C2DM sample, though, we have you type in your Google account name in an EditText, then click a Button to perform the registration:

```
<?xml version="1.0" encoding="utf-8"?>
<LinearLayout xmlns:android="http://schemas.android.com/apk/res/android"
  android:orientation="vertical"
  android:layout_width="match_parent"
  android:layout_height="match_parent"
  >
  <EditText android:id="@+id/account"
    android:layout_width="match_parent"
    android:layout_height="wrap_content"
    android:layout_marginBottom="4dip"
  />
  <Button
    android:layout_width="match_parent"
    android:layout_height="wrap_content"
    android:text="Register!"
    android:onClick="registerAccount"
  />
</LinearLayout>
```

Using the Google C2DM client code, all you need to do to register for messages is call `C2DMessaging.register()`, supplying a `Context` (e.g., your `Activity`) and the Google account name:

```
package com.commonware.android.c2dm;

import android.app.Activity;
```



## PUSH NOTIFICATIONS WITH C2DM

---

```
import android.os.Bundle;
import android.view.View;
import android.widget.EditText;
import com.google.android.c2dm.C2DMessaging;

public class PushEndpointDemo extends Activity {
    @Override
    public void onCreate(Bundle savedInstanceState) {
        super.onCreate(savedInstanceState);
        setContentView(R.layout.main);
    }

    public void registerAccount(View v) {
        EditText acct=(EditText)findViewById(R.id.account);

        C2DMessaging.register(this, acct.getText().toString());
    }
}
```

To get your registration ID, and to receive messages later on, you will need to receive the broadcasts sent out by Google's on-device C2DM code. If you are using Google's C2DM client code, you can do this by implementing a class named C2DMReceiver, as a subclass of C2DMBaseReceiver:

```
package com.commonsware.android.c2dm;

import android.content.Context;
import android.content.Intent;
import android.util.Log;
import com.google.android.c2dm.C2DMBaseReceiver;

public class C2DMReceiver extends C2DMBaseReceiver {
    public C2DMReceiver() {
        super("this.is.not@real.biz");
    }

    @Override
    public void onRegistered(Context context, String registrationId) {
        Log.w("C2DMReceiver-onRegistered", registrationId);
    }

    @Override
    public void onUnregistered(Context context) {
        Log.w("C2DMReceiver-onUnregistered", "got here!");
    }

    @Override
    public void onError(Context context, String errorId) {
        Log.w("C2DMReceiver-onError", errorId);
    }

    @Override
```

## PUSH NOTIFICATIONS WITH C2DM

---

```
protected void onMessage(Context context, Intent intent) {  
    Log.w("C2DMReceiver", intent.getStringExtra("payload"));  
}  
}
```

You must override the `onMessage()` and `onError()` methods, as they are declared abstract in `C2DMBaseReceiver`. `onMessage()` will be called when a message arrives; `onError()` will be called if there is some problem. Typically, you will also override `onRegistered()`, where you will get your registration ID and can pass that along to your Web service... or just dump it to LogCat, as shown above. You might also consider overriding `onUnregistered()`, which will be called if you call `C2DMessaging.unregister()` at some point to retract your interest in messages from this Google account. Also, `C2DMBaseReceiver` requests that you supply the Google account in the constructor. The sample application hard-wires in a fake value, because the real Google account is being supplied via the `EditText` – your production code can probably hard-wire in the proper account name. Reportedly, this is only used for logging purposes at this time.

We will explain a bit more about how you interpret received messages later in this chapter.

You also need to add a few things to your manifest, above and beyond the permissions cited in the previous section.

First, you need to add your `C2DMReceiver` service, just as an ordinary `<service>` element, with no `<intent-filter>` required:

```
<service android:name=".C2DMReceiver"/>
```

Then, you need to add `C2DMBroadcastReceiver`, via a `<receiver>` element, to your manifest. This class, supplied by the Google C2DM client code, will receive the C2DM broadcasts and will route them to your `C2DMReceiver` class. The `<receiver>` element is a little unusual:

```
<receiver  
    android:name="com.google.android.c2dm.C2DMBroadcastReceiver"  
    android:permission="com.google.android.c2dm.permission.SEND">  
    <intent-filter>  
        <action android:name="com.google.android.c2dm.intent.RECEIVE"/>  
  
        <category android:name="com.commonware.android.c2dm"/>  
    </intent-filter>  
    <intent-filter>  
        <action android:name="com.google.android.c2dm.intent.REGISTRATION"/>  
    </intent-filter>  
</receiver>
```

## PUSH NOTIFICATIONS WITH C2DM

---

```
<category android:name="com.commonware.android.c2dm" />
</intent-filter>
</receiver>
```

Specifically:

1. The `android:name` attribute has to specify the full class name, including package, since this is a class from Google's C2DM client code, not your own package
2. For your protection, you should have the `android:permission="com.google.android.c2dm.permission.SEND"` attribute, to require the broadcaster of the Intent to hold that permission, to further limit the ability for other applications to spoof messages from your app
3. You need `<intent-filter>` elements for the `com.google.android.c2dm.intent.RECEIVE` and `com.google.android.c2dm.intent.REGISTRATION` actions, where the category for those filters is your application's package (`com.commonware.android.c2dm` in this sample) — this ensures that the broadcasts will only go to your application, not to anyone else's

This is all largely boilerplate, except for the custom category values.

If you do all of that and register a Google account, you will get a registration ID back. This is a 120 character cryptic string that your server will need to send messages to this specific app on this specific device.

While this all seems a little bit complicated, the Google C2DM client code wraps up most of the ugliness — your code could be even *more* complicated!

## Push It Real Good

Your server need to get the registration IDs from instances of your app, then send messages to those IDs when appropriate. Sending a message is a matter of doing 1 or 2 HTTP POST requests, and therefore can be accomplished by any serious server-side programming environment. You do not even strictly need a server for this — the Push/C2DM sample project will demonstrate sending a message using the [curl command-line HTTP client](#).

### Getting Authenticated

Before you can send a message, you need to authenticate yourself with Google's C2DM servers. This involves an HTTP POST request, where you supply your account credentials and get in return an authentication token. This uses the same basic logic that is used to log into any Google server for any of their exposed APIs, and there are client libraries for Google authentication available for many programming languages.

Here is the `auth.sh` script from the Push/C2DM project, showing how to perform an authentication request using `curl`:

```
curl https://www.google.com/accounts/ClientLogin -d Email=$1 -d "Passwd=$2" -d accountType=GOOGLE -d source=Google-cURL-Example -d service=ac2dm
```

This script expects two command-line parameters: your Google account name (e.g., `foo@gmail.com`) and its password. The `curl` command supplies those two values with three others in a request to `ClientLogin`:

- The `accountType`, which is `GOOGLE` if your account is a plain Google account or `HOSTED` if your account comes from one managed by Google App for your domain
- The `source`, which apparently is an arbitrary string identifying what is making the authentication request
- The `service`, which must be `ac2dm` for this to work

The result will be text response with three long strings, named `LID`, `SID`, and `Auth`. You will need the `Auth` value. This is a 160-character string, representing a token showing that you have been authenticated. This token will be good for several days, so you do not need to request a fresh `Auth` token on each message. Ideally, you do not even store the Google account information on the server, lest your server be hacked and that account be put to ill use. Instead, store the `Auth` token somewhere on the server and refresh it periodically. Also, a request to send a message will include an `Update-Client-Auth` header with a fresh `Auth` token if the Google C2DM servers determine that your existing token will expire soon.

### Sending a Notification

Given the 120-character registration ID and the 160-character `Auth` token, you can now send a message to the app. This involves doing an HTTP POST to the C2DM servers themselves, as shown in the `post.sh curl` script:

---

## PUSH NOTIFICATIONS WITH C2DM

---

```
curl --header "Authorization: GoogleLogin auth=$1"  
"https://android.apis.google.com/c2dm/send" -d registration_id=$2 -d  
"data.payload=$3" -d collapse_key=something
```

This script expects three command-line parameters:

- The Auth token
- The registration ID
- The “payload” — a simple string that will be sent to the app

The Auth token goes in a GoogleAuth Authorization HTTP header. The registration ID is supplied as a parameter on the POST request, along with:

1. Your specified payload, as a POST parameter named `data.payload`
2. The `collapse_key`, which will be explained later in this chapter

### About the Message

You can pass up to 1,024 characters’ worth of data in your message, spread across one or more values. Each POST parameter prefixed with `data.` will be considered part of the message and will be put into the Intent sent to your `C2DMReceiver` class as a `String` extra (minus the `data.` prefix). Hence, the `sample.post.sh` script uses `data.payload` for your message, and the `sample.C2DMReceiver` implementation retrieves that via the `payload` Intent extra. While this sample only shows a single value being sent, you can provide several `data.` POST parameters if you wish, so long as they combine to be under 1,024 characters.

## A Controlled Push

Of course, the `Push/C2DM` sample project is a simplified look at the entire push notification process. When you start dealing with thousands of users and thousands of messages, things get a wee bit more complicated. Here are a couple of control points you should be aware of as you think about applying these techniques to a production application.

### Message Parameters

Devices may not be in position to receive messages right away. While the delay may be temporary, it could be of indefinite duration. Somebody having their phone turned off, or on “airplane mode”, for an extended period is an obvious example. Even if the phone is on and operating normally, though, it may be that the socket

## PUSH NOTIFICATIONS WITH C2DM

---

connection between the device and the C2DM servers has been interrupted, and the power-optimized on-device C2DM code may be a bit slow to re-establish the connection. At the same time, you are going to be sending out messages typically based on your own schedule, such as in response to external data sources, ignorant of what is going on with any given device.

Google is not considering C2DM to be a guaranteed store-and-forward queue system. In particular, Google reserves the right to try to coalesce messages, in part to reduce storage demands, but also so as not to flood the device when a connection is re-established.

Key to this is the `collapse_key` parameter on the message request. If a device is unavailable, and during that time you send two or more messages with the same `collapse_key`, the C2DM servers may elect to only send one of those messages — typically the last one, though not necessarily. You can use this to your advantage, to minimize processing you need to do on the client. For example, if your use of C2DM is to alert your custom email application that “you’ve got mail”, you can use a consistent `collapse_key` with messages telling the client how many unread emails are in their inbox. That can be used by the client to update a Notification and, eventually, cajole the user into actually reading her mail.

A related optional parameter you can include in your messages is `delay_while_idle`. If you specify this as a POST parameter, that will indicate to the C2DM servers that, while you want the message to be delivered, it is not important enough to wake up the device. C2DM will hold onto the message (or the last one if several are sent with the same `collapse_key`), but it will not push it to the device until it knows the device is awake (perhaps due to another C2DM message for that device lacking this parameter). You can think of this as being akin to choosing an `AlarmManager` alarm type lacking the `_WAKEUP` suffix. The goal is to minimize battery consumption.

### Notable Message Responses

When you send a message, you should get a 200 OK response from the C2DM servers. If everything went well, you will get back a body of the form `id=...`, where `...` is some unique ID of the message. If, however, you get a body of `Error=...`, that means something went wrong.

Some errors, like `MissingCollapseKey`, will probably be found and fixed during development. Some errors, like `MessageTooBig`, are hopefully found during stress testing. Others, though, may legitimately happen during normal operations. In particular, here are four to watch for:

- `QuotaExceeded` and `DeviceQuotaExceeded` will be returned if you have sent too many messages too quickly, either in general (`QuotaExceeded`) or to a specific device (`DeviceQuotaExceeded`). Google would appreciate it if you would try again later, perhaps using some sort of [exponential back-off algorithm](#).
- `InvalidRegistration` means that the registration ID you supplied is incorrect. This suggests there is some form of corruption in the channel by which you got that registration ID to the server.
- `NotRegistered`, for a registration ID that used to work, means that the user has unregistered that ID, and it should no longer be used. If you get `NotRegistered` from the beginning, there may be a problem with your C2DM setup. In particular, during this beta period, it may mean there are problems with your Google ID that was added to the beta test whitelist.

## The Right Way to Push

Google recommends that you use C2DM not to deliver data, but to deliver a wakeup call to your application, which then goes and pulls the data. C2DM is not a guaranteed store-and-forward engine — that, coupled with the `collapse_key` concept, means that not every one of your messages will make it through to the device. If you put “real data” in the C2DM message, that data may be lost. Also, this means you will (hopefully) never run into the 1,024-byte cap on message length.

You may also need to do push by some means *other* than C2DM, in all likelihood. C2DM has two key limitations:

- It only works on devices running Android 2.2 and higher, which at the time of this writing is a very small percentage of the market
- It requires some of the infrastructure that powers the Play Store, and so may not be available on devices lacking the Play Store, such as the Kindle Fire

The first limitation will fall away in time; how much the second limitation impacts you will be determined by the mix of devices your users are using. If a significant number are using older or non-Google Play devices, you will need some separate solution: polling, WebSockets, etc.

# **Other System Settings and Services**

---

Android offers a number of system services, usually obtained by `getSystemService()` from your Activity, Service, or other Context. These are your gateway to all sorts of capabilities, from settings to volume to WiFi. Throughout the course of this book, we have seen several of these system services. In this chapter, we will take a look at others that may be of value to you in building compelling Android applications.

## **Prerequisites**

Understanding this chapter requires that you have read the core chapters of this book.

## **Setting Expectations**

If you have an Android device, you probably have spent some time in the Settings application, tweaking your device to work how you want – ringtones, WiFi settings, USB debugging, etc. Many of those settings are also available via Settings class (in the `android.provider` package), and particularly the `Settings.System` and `Settings.Secure` public inner classes.

## **Basic Settings**

`Settings.System` allows you to get and, with the `WRITE_SETTINGS` permission, alter these settings. As one might expect, there are a series of typed getter and setter methods on `Settings.System`, each taking a key as a parameter. The keys are class constants, such as:



## OTHER SYSTEM SETTINGS AND SERVICES

---

1. `INSTALL_NON_MARKET_APPS` to control whether you can install applications on a device from outside of the Play Store
2. `HAPTIC_MODE_ENABLED` to control whether the user receives “haptic feedback” (vibrations) from things like the MENU button
3. `ACCELEROMETER_ROTATION` to control whether the screen orientation will change based on the position of the device

The [SystemServices/Settings](#) sample project has a `SettingsSetter` sample application that displays a checklist:

```
<?xml version="1.0" encoding="utf-8"?>
<ListView xmlns:android="http://schemas.android.com/apk/res/android"
    android:id="@android:id/list"
    android:layout_width="fill_parent"
    android:layout_height="fill_parent"
/>
```

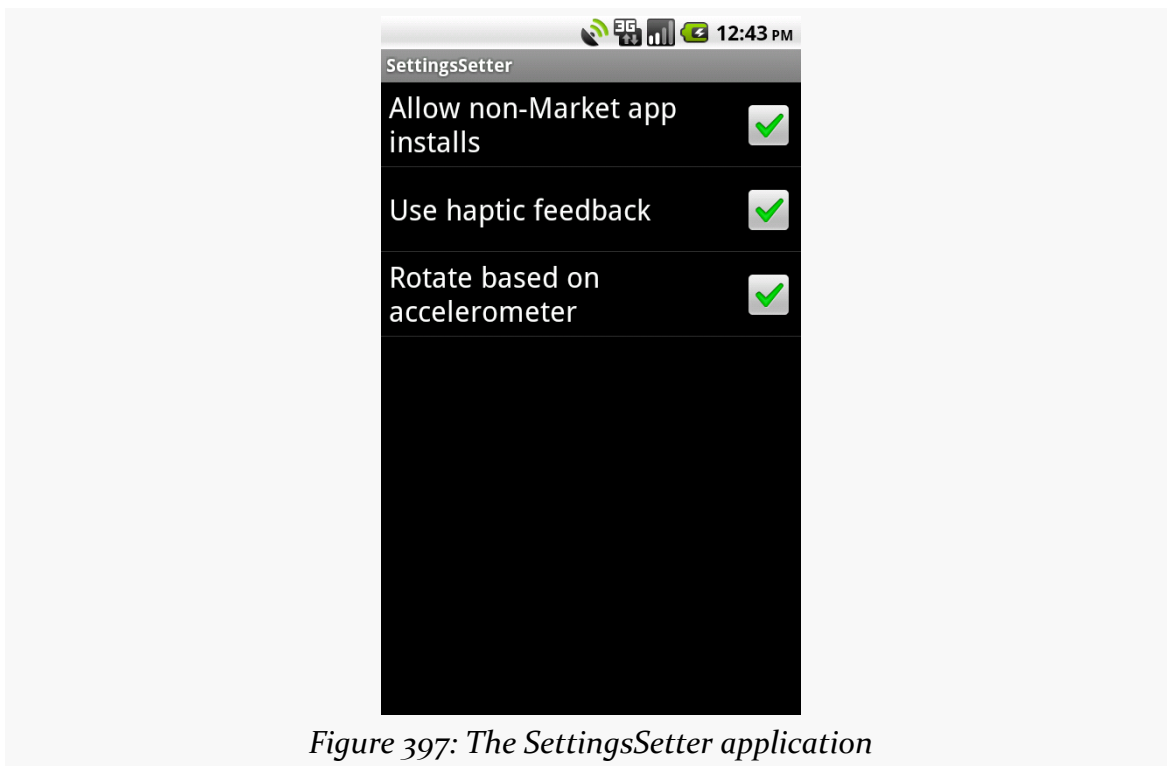


Figure 397: The `SettingsSetter` application

The checklist itself is filled with a few `BooleanSetting` objects, which map a display name with a `Settings.System` key:

```
static class BooleanSetting {
    String key;
```

## OTHER SYSTEM SETTINGS AND SERVICES

---

```
String displayName;
boolean isSecure=false;

BooleanSetting(String key, String displayName) {
    this(key, displayName, false);
}

BooleanSetting(String key, String displayName,
                boolean isSecure) {
    this.key=key;
    this.displayName=displayName;
    this.isSecure=isSecure;
}

@Override
public String toString() {
    return(displayName);
}

boolean isChecked(ContentResolver cr) {
    try {
        int value=0;

        if (isSecure) {
            value=Settings.Secure.getInt(cr, key);
        }
        else {
            value=Settings.System.getInt(cr, key);
        }

        return(value!=0);
    }
    catch (Settings.SettingNotFoundException e) {
        Log.e("SettingsSetter", e.getMessage());
    }

    return(false);
}

void setChecked(ContentResolver cr, boolean value) {
    try {
        if (isSecure) {
            Settings.Secure.putInt(cr, key, (value ? 1 : 0));
        }
        else {
            Settings.System.putInt(cr, key, (value ? 1 : 0));
        }
    }
    catch (Throwable t) {
        Log.e("SettingsSetter", "Exception in setChecked()", t);
    }
}
}
```

## OTHER SYSTEM SETTINGS AND SERVICES

---

Three such settings are put in the list:

```
settings.add(new BooleanSetting(Settings.System.INSTALL_NON_MARKET_APPS,
    "Allow non-Market app installs",
    true));
settings.add(new BooleanSetting(Settings.System.HAPTIC_FEEDBACK_ENABLED,
    "Use haptic feedback",
    false));
settings.add(new BooleanSetting(Settings.System.ACCELEROMETER_ROTATION,
    "Rotate based on accelerometer",
    false));
```

As the checkboxes are checked and unchecked, the values are passed along to the settings themselves:

```
@Override
protected void onItemClick(ListView l, View v,
    int position, long id) {
    super.onItemClick(l, v, position, id);

    BooleanSetting s=settings.get(position);

    s.setChecked(getContentResolver(),
        l.isItemChecked(position));
}
```

The SettingsSetter activity also has an option menu containing four items:

```
<?xml version="1.0" encoding="utf-8"?>
<menu xmlns:android="http://schemas.android.com/apk/res/android">
    <item android:id="@+id/app"
        android:title="Application"
        android:icon="@android:drawable/ic_menu_manage" />
    <item android:id="@+id/security"
        android:title="Security"
        android:icon="@android:drawable/ic_menu_close_clear_cancel" />
    <item android:id="@+id/wireless"
        android:title="Wireless"
        android:icon="@android:drawable/ic_menu_set_as" />
    <item android:id="@+id/all"
        android:title="All Settings"
        android:icon="@android:drawable/ic_menu_preferences" />
</menu>
```

These items correspond to four activity Intent values identified by the Settings class:

```
menuActivities.put(R.id.app,
    Settings.ACTION_APPLICATION_SETTINGS);
menuActivities.put(R.id.security,
```

## OTHER SYSTEM SETTINGS AND SERVICES

---

```
        Settings.ACTION_SECURITY_SETTINGS);
menuActivities.put(R.id.wireless,
        Settings.ACTION_WIRELESS_SETTINGS);
menuActivities.put(R.id.all,
        Settings.ACTION_SETTINGS);
```

When an option menu is chosen, the corresponding activity is launched:

```
@Override
public boolean onOptionsItemSelected(MenuItem item) {
    String activity=menuActivities.get(item.getItemId());

    if (activity!=null) {
        startActivity(new Intent(activity));

        return(true);
    }

    return(super.onOptionsItemSelected(item));
}
```

This way, you have your choice of either directly manipulating the settings or merely making it easier for users to get to the Android-supplied activity for manipulating those settings.

### Secure Settings

You will notice that if you use the above code and try changing the Play Store setting, it does not seem to take effect. And, if you look at the LogCat output, you will see complaints.

Once upon a time, you could modify this setting, and others like it.

Now, though, these settings are ones that Android deems “secure”. The constants have been moved from `Settings.System` to `Settings.Secure`, though the old constants are still there, flagged as deprecated.

These so-called “secure” settings are ones that Android does not allow applications to change. While theoretically the `WRITE_SECURE_SETTINGS` permission resolves this problem, ordinary SDK applications cannot hold that permission. The only option is to display the official Settings activity and let the user change the setting.

API Level 17 takes things one step further, moving a number of settings out of `Settings.System` and `Settings.Secure` and placing them in a new `Settings.Global`. Like `Settings.Secure`, ordinary SDK apps cannot modify these

settings, as they are secured by `WRITE_SECURE_SETTINGS`. The distinction between `Settings.Secure` and `Settings.Global` comes with respect to scope: `Settings.Secure` is on a per-user basis (for devices set up with multiple users), and `Settings.Global` is device-wide.

## Can You Hear Me Now? OK, How About Now?

The fancier the device, the more complicated controlling sound volume becomes.

On a simple MP3 player, there is usually only one volume control. That is because there is only one source of sound: the music itself, played through speakers or headphones.

In Android, though, there are several sources of sounds:

1. Ringing, to signify an incoming call
2. Voice calls
3. Alarms, such as those raised by the Alarm Clock application
4. System sounds (error beeps, USB connection signal, etc.)
5. Music, as might come from the MP3 player

Android allows the user to configure each of these volume levels separately. Usually, the user does this via the volume rocker buttons on the device, in the context of whatever sound is being played (e.g., when on a call, the volume buttons change the voice call volume). Also, there is a screen in the Android Settings application that allows you to configure various volume levels.

The `AudioService` in Android allows you, the developer, to also control these volume levels, for all five “streams” (i.e., sources of sound). In the [SystemServices/Volume](#) sample project, we create a `Volumizer` application that displays and modifies all five volume levels.

## Attaching SeekBars to Volume Streams

The standard widget for allowing choice along a range of integer values is the `SeekBar`, a close cousin of the `ProgressBar`. `SeekBar` has a thumb that the user can slide to choose a value between 0 and some maximum that you set. So, we will use a set of five `SeekBar` widgets to control our five volume levels.

First, we need to create a layout with a `SeekBar` per stream:

## OTHER SYSTEM SETTINGS AND SERVICES

---

```
<?xml version="1.0" encoding="utf-8"?>
<TableLayout xmlns:android="http://schemas.android.com/apk/res/android"
  xmlns:app="http://schemas.android.com/apk/res/
com.commonware.android.syssvc.volume"
  android:layout_width="fill_parent"
  android:layout_height="fill_parent"
  android:stretchColumns="1">

  <TableRow
    android:paddingBottom="20px"
    android:paddingTop="10px">

    <TextView android:text="Alarm:"/>

    <SeekBar
      android:id="@+id/alarm"
      android:layout_width="fill_parent"
      android:layout_height="wrap_content"/>
  </TableRow>

  <TableRow android:paddingBottom="20px">

    <TextView android:text="Music:"/>

    <SeekBar
      android:id="@+id/music"
      android:layout_width="fill_parent"
      android:layout_height="wrap_content"/>
  </TableRow>

  <TableRow android:paddingBottom="20px">

    <TextView android:text="Ring:"/>

    <SeekBar
      android:id="@+id/ring"
      android:layout_width="fill_parent"
      android:layout_height="wrap_content"/>
  </TableRow>

  <TableRow android:paddingBottom="20px">

    <TextView android:text="System:"/>

    <SeekBar
      android:id="@+id/system"
      android:layout_width="fill_parent"
      android:layout_height="wrap_content"/>
  </TableRow>

  <TableRow>

    <TextView android:text="Voice:"/>


```

## OTHER SYSTEM SETTINGS AND SERVICES

---

```
<SeekBar
    android:id="@+id/voice"
    android:layout_width="fill_parent"
    android:layout_height="wrap_content"/>
</TableRow>
</TableLayout>
```

Then, we need to wire up each of those bars in the `onCreate()` for `Volumizer`, calling an `initBar()` method for each of the five bars:

```
@Override
public void onCreate(Bundle savedInstanceState) {
    super.onCreate(savedInstanceState);
    setContentView(R.layout.main);

    mgr=(AudioManager) getSystemService(Context.AUDIO_SERVICE);

    alarm=(SeekBar) findViewById(R.id.alarm);
    music=(SeekBar) findViewById(R.id.music);
    ring=(SeekBar) findViewById(R.id.ring);
    system=(SeekBar) findViewById(R.id.system);
    voice=(SeekBar) findViewById(R.id.voice);

    initBar(alarm, AudioManager.STREAM_ALARM);
    initBar(music, AudioManager.STREAM_MUSIC);
    initBar(ring, AudioManager.STREAM_RING);
    initBar(system, AudioManager.STREAM_SYSTEM);
    initBar(voice, AudioManager.STREAM_VOICE_CALL);
}
```

In `initBar()`, we set the appropriate size for the `SeekBar` bar via `setMax()`, set the initial value via `setProgress()`, and hook up an `OnSeekBarChangeListener` to find out when the user slides the bar, so we can set the volume on the stream via the `VolumeManager`.

The net result is that when the user slides a `SeekBar`, it adjusts the stream to match:

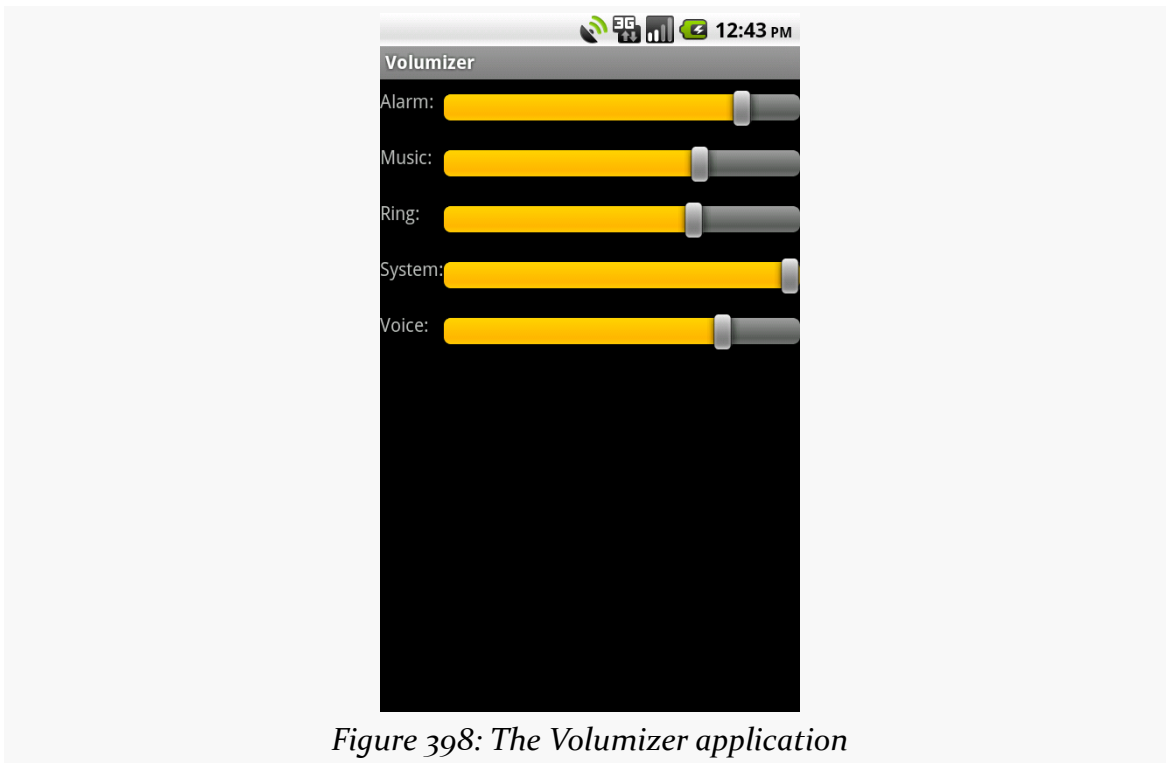


Figure 398: The Volumizer application

## The Rest of the Gang

There are quite a few system services you can get from `getSystemService()`. Beyond the ones profiled in this chapter, you have access to:

1. `AccessibilityManager`, for being notified of key system events (e.g., activities starting) that might be relayed to users via haptic feedback, audio prompts, or other non-visual cues
2. `AccountManager`, for working with Android's system of user accounts and synchronization
3. `ActivityManager`, for getting more information about what processes and components are presently running on the device
4. `AlarmManager`, for scheduled tasks (a.k.a., "cron jobs"), covered [elsewhere in this book](#)
5. `ConnectivityManager`, for a high-level look as to what sort of network the device is connected to for data (e.g., WiFi, 3G)
6. `DevicePolicyManager`, for accessing device administration capabilities, such as wiping the device



## OTHER SYSTEM SETTINGS AND SERVICES

---

7. DownloadManager, for downloading large files on behalf of the user, covered in [the chapter on Intents](#)
8. DropBoxManager, for maintaining your own ring buffers of logging information akin to LogCat
9. InputMethodManager, for working with input method editors
10. KeyguardManager, for locking and unlocking the keyguard, where possible
11. LayoutInflater, for inflating layout XML files into Views, covered elsewhere in this book
12. LocationManager, for determining the device's location (e.g., GPS), covered in [the chapter on location tracking](#)
13. NotificationManager, for putting icons in the status bar and otherwise alerting users to things that have occurred asynchronously, covered in [the chapter on Notification](#)
14. PowerManager, for obtaining WakeLock objects and such, covered [elsewhere in this book](#)
15. SearchManager, for interacting with the global search system – search in general is covered [elsewhere in this book](#)
16. SensorManager, for accessing data about sensors, such as the accelerometer
17. TelephonyManager, for finding out about the state of the phone and related data (e.g., SIM card details)
18. UiModeManager, for dealing with different “UI modes”, such as being docked in a car or desk dock
19. Vibrator, for shaking the phone (e.g., haptic feedback)
20. WifiManager, for getting more details about the active or available WiFi networks
21. WindowManager, mostly for accessing details about the default display for the device

# Dealing with Different Hardware

---

While a lot of focus is placed on screen sizes, there are many other possible hardware differences among different Android devices. For example, some have telephony features, while others do not.

There is a three-phase plan for dealing with these variations:

1. **Filter** out devices that cannot possibly run your app successfully, so your app will not appear to them in the Play Store and they will be unable to install your app if obtained by other means
2. **React** to varying hardware that you can support, but perhaps might support differently (e.g., choosing a particular flash mode for a device having a camera with a flash)
3. **Cope** with device bugs or regressions that impact your application

This chapter will go through each of these topics.

## Prerequisites

Understanding this chapter requires that you have read the core chapters of this book.

## Filtering Out Devices

Elsewhere in the book, we discussed a few manifest entries that will serve to filter out devices that cannot run your app:

## DEALING WITH DIFFERENT HARDWARE

---

- [android:minSdkVersion in the <uses-sdk> element](#), to stipulate that devices must run a certain version of Android (or higher)
- [<supports-screens> and <compatible-screens>](#), which indicate which screens sizes and densities you are capable of supporting

This section outlines other “advertisements” that you can put in the manifest to restrict which devices run your app.

### uses-feature

The `<uses-feature>` element restricts your app to devices that have certain hardware features. For each element, you supply the name of a feature (e.g., `android.hardware.telephony`) and whether or not it is required:

```
<uses-feature
  android:name="android.hardware.camera"
  android:required="false" />
```

By default, `android:required` is set to `true`, so typically you will only see it in a manifest when it is set to `false`.

You might wonder why we would bother ever setting `android:required` to `false`. After all, that should have the same effect as not listing it at all. In practice, though, it has two major uses.

First, markets like the Play Store might highlight the fact that you *can* use a particular hardware capability, even though you do not strictly require it.

More importantly, you can use `android:required="false"` to *undo* a *requirement* that Android infers from your permissions. Requesting some permissions causes Android to assume — for backwards-compatibility reasons — that your app needs the affiliated hardware. For example, requesting the `CAMERA` permission causes Android to assume that you need a camera (`android.hardware.camera`) *and* that the camera support auto-focus (`android.hardware.camera.autofocus`). If, however, you are requesting the permission because you would like to use the hardware if available, but can live without it, you need to expressly add a `<uses-feature>` element declaring that the hardware feature is not required.

For example, in February 2010, the Motorola XOOM tablet was released. This was the first Android device that had the Play Store on it and truly had no telephony capability. As such, the XOOM would be filtered out of the then-Android Market (now Play Store) for any app that required permissions like `SEND_SMS`. Many

developers requested this permission, even though their apps could survive without SMS-sending capability. However, their apps were still filtered out if they did not have the `<uses-feature>` element declaring that telephony was not required.

You can find a table listing Android permissions and assumed hardware feature requirements in [the Android developer documentation](#).

### uses-configuration

The `<uses-configuration>` element is very reminiscent of `<uses-feature>`: it dictates hardware requirements. The difference is two-fold:

1. It focuses on hardware elements that represent different device configurations, meaning that you might use different resources for them
2. It allows you to specify *combinations* of capabilities that you need

There are three capabilities that you can require via `<uses-configuration>`:

1. The existence of a five-way navigation control, whether a specific type (D-pad, trackball, etc.) or any such control
2. The existence of a physical keyboard, whether a specific type (QWERTY, 12-key numeric keypad, etc.) or any such keyboard
3. A touchscreen

You can have as many `<uses-configuration>` elements as you need – any device that matches at least one such configuration will be eligible to install your app.

For example, the following `<uses-configuration>` element restricts your app to devices that have some sort of navigation control but do not necessarily have a touchscreen, such as a Google TV device:

```
<uses-configuration  
  android:reqFiveWayNav="true"  
  android:reqTouchScreen="notouch" />
```

### uses-library

The `<uses-library>` element tells Android that your application wishes to use a particular *firmware*-supplied library. The most common case for this is Google Maps, which is shipped in the form of an SDK add-on and firmware library. You can see `<uses-library>` in use with Google Maps V1 [elsewhere in this book](#).

However, there are other firmware libraries that you might need. These will typically be manufacturer-specific libraries, allowing your application to take advantage of particular beyond-the-Android-SDK capabilities of a particular device. For example, several Motorola Mobility devices ship with an [“Enterprise Device Management” firmware library](#), as an extension of Android’s own device admin APIs.

The Google Play Store will filter out your application from devices that lack a firmware library that you require via `<uses-library>`. If the user tries installing your app by some other means (e.g., download from a Web site), your app will fail to install on devices that lack the firmware library.

If you conditionally want the firmware library — you will use it if available but can cope if it is not — you can add `android:required="false"` to your `<uses-library>` element. That will allow your app to install and run on devices missing the library in question. Detecting whether or not the library exists in your process at runtime will be covered [later in this chapter](#).

## Runtime Capability Detection

Reacting to device capabilities is the second phase of dealing with different devices. Some features you might want (e.g., telephony for sending SMSes) but can live without. Other features may have subtle variations that you cannot filter against and therefore need to adapt to at runtime (e.g., possible picture resolutions off of a camera).

This section will cover various techniques for determining what a device can do, at runtime, so you can react accordingly.

### Features

Any feature you do not make required via `<uses-feature>` can be detected at runtime by calling `hasSystemFeature()` on `PackageManager`. For example, if you would like to send SMS messages, but only on telephony-capable devices, you could have the following `<uses-feature>` element:

```
<uses-feature
  android:name="android.hardware.telephony"
  android:required="false" />
```

Then, at runtime, you can call `hasSystemFeature("android.hardware.telephony")` on a `PackageManager` instance to find out if, indeed, the device has telephony capability and sending SMSes should work.

### Other Capabilities

Various subsystems have their own means of helping you determine what is possible or not:

- The [Camera class](#), via `Camera.Parameters`, can let you know the capabilities of a camera (e.g., whether or not it has a flash, and what specific flash modes are supported).
- The [LocationManager](#) will help you determine what location providers are available that meet your `Criteria`.
- The sensor subsystem lets you find out what sensors are installed, either overall or for a particular type (e.g., accelerometer).

### Dealing with Device Bugs

Alas, devices are not perfect. Even though [the Compatibility Test Suite](#) attempts to ensure that all Android devices legitimately running the Play Store faithfully implement the Android SDK, some device manufacturers make changes that introduce bugs.

Just as Web developers can “sniff” on the User-Agent HTTP header to determine what sort of browser is requesting a page, you can use the `Build` class to determine what sort of device is running your app. If you encounter problems with a specific device, you may be able to use `Build` to identify that device at runtime and “route around the damage”.



# Responding to URLs

---

You may have noticed that Android supports a `market:` URL scheme. Web pages can use such URLs so that, if they are viewed on an Android device's browser, the user can be transported to an Play Store page, perhaps for a specific app or a list of apps for a publisher.

Fortunately, that mechanism is not limited to Android's code — you can get control for various other types of links as well. You do this by adding certain entries to an activity's `<intent-filter>` for an `ACTION_VIEW` Intent.

## Prerequisites

Understanding this chapter requires that you have read the chapter on [Intent filters](#).

## Manifest Modifications

First, any `<intent-filter>` designed to respond to browser links will need to have a `<category>` element with a name of `android.intent.category.BROWSABLE`. Just as the `LAUNCHER` category indicates an activity that should get an icon in the launcher, the `BROWSABLE` category indicates an activity that wishes to respond to browser links.

You will then need to further refine which links you wish to respond to, via a `<data>` element. This lets you describe the URL and/or MIME type that you wish to respond to. For example, here is the `AndroidManifest.xml` file from the [Introspection/URLHandler](#) sample project:

```
<?xml version="1.0" encoding="utf-8"?>
<manifest xmlns:android="http://schemas.android.com/apk/res/android"
```



## RESPONDING TO URLS

---

```
package="com.commonware.android.urlhandler"
android:versionCode="1"
android:versionName="1.0">

<supports-screens
    android:largeScreens="true"
    android:normalScreens="true"
    android:smallScreens="false"/>

<application
    android:icon="@drawable/cw"
    android:label="@string/app_name">
    <activity
        android:name="URLHandler"
        android:label="@string/app_name">
        <intent-filter>
            <action android:name="android.intent.action.MAIN"/>

            <category android:name="android.intent.category.LAUNCHER"/>
        </intent-filter>
        <intent-filter>
            <action android:name="android.intent.action.VIEW"/>

            <category android:name="android.intent.category.DEFAULT"/>
            <category android:name="android.intent.category.BROWSABLE"/>

            <data android:mimeType="application/pdf"/>
        </intent-filter>
        <intent-filter>
            <action android:name="android.intent.action.VIEW"/>

            <category android:name="android.intent.category.DEFAULT"/>
            <category android:name="android.intent.category.BROWSABLE"/>

            <data
                android:host="www.this-so-does-not-exist.com"
                android:path="/something"
                android:scheme="http"/>
        </intent-filter>
        <intent-filter>
            <action android:name="com.commonware.android.MY_ACTION"/>

            <category android:name="android.intent.category.DEFAULT"/>
            <category android:name="android.intent.category.BROWSABLE"/>
        </intent-filter>
    </activity>
</application>
</manifest>
```

Here, we have four `<intent-filter>` elements for our one activity:

- The first is a standard “put an icon for me in the launcher, please” filter, with the LAUNCHABLE category
- The second claims that we handle PDF files (MIME type of application/pdf), and that we will respond to browser links (BROWSABLE category)
- The third claims that we will handle any HTTP request (scheme of "http") for a certain Web site (host of "www.this-so-does-not-exist.com"), and that we will respond to browser links (BROWSABLE category)
- The last is a custom action, for which we will generate a URL that Android will honor, and that we will respond to browser links (BROWSABLE category)

Note that the last one also requires the DEFAULT category in order to work.

## Creating a Custom URL

Responding to MIME types makes complete sense... if we implement something designed to handle such a MIME type.

Responding to certain schemes, hosts, paths, or file extensions is certainly usable, but other than perhaps the file extension approach, it makes your application a bit fragile. If the site changes domain names (even a sub-domain) or reorganizes its site with different URL structures, your code will break.

If the goal is simply for you to be able to trigger your own application from your own Web pages, though, the safest approach is to use an `intent: URL`. These can be generated from an Intent object by calling `toUri(Intent.URI_INTENT_SCHEME)` on a properly-configured Intent, then calling `toString()` on the resulting `Uri`.

For example, the `intent: URL` for the fourth `<intent-filter>` from above is:

```
intent:#Intent;action=com.commonware.android.MY_ACTION;end
```

This is not an official URL scheme, any more than `market:` is, but it works for Android devices. When the Android built-in Browser encounters this URL, it will create an Intent out of the URL-serialized form and call `startActivity()` on it, thereby starting your activity.

## Reacting to the Link

Your activity can then examine the Intent that launched it to determine what to do. In particular, you will probably be interested in the `Uri` corresponding to the link —

## RESPONDING TO URLS

---

this is available via the `getData()` method. For example, here is the `URLHandler` activity for this sample project:

```
package com.commonware.android.urlhandler;

import android.app.Activity;
import android.content.Intent;
import android.net.Uri;
import android.os.Bundle;
import android.util.Log;
import android.view.View;
import android.widget.TextView;

public class URLHandler extends Activity {
    @Override
    public void onCreate(Bundle savedInstanceState) {
        super.onCreate(savedInstanceState);
        setContentView(R.layout.main);

        TextView uri=(TextView)findViewById(R.id.uri);

        if (Intent.ACTION_MAIN.equals(getIntent().getAction())) {
            String intentUri=(new Intent("com.commonware.android.MY_ACTION")
                .toUri(Intent.URI_INTENT_SCHEME)
                .toString());

            uri.setText(intentUri);
            Log.w("URLHandler", intentUri);
        }
        else {
            Uri data=getIntent().getData();

            if (data==null) {
                uri.setText("Got com.commonware.android.MY_ACTION Intent");
            }
            else {
                uri.setText(getIntent().getData().toString());
            }
        }
    }

    public void visitSample(View v) {
        startActivity(new Intent(Intent.ACTION_VIEW,
            Uri.parse("http://commonware.com/sample")));
    }
}
```

This activity's layout has a `TextView` (`uri`) for showing a `Uri` and a `Button` to launch a page of links, found on the CommonsWare site (<http://commonware.com/sample>). The `Button` is wired to call `visitSample()`, which just calls `startActivity()` on the aforementioned URL to display it in the Browser.

## RESPONDING TO URLS

---

When the activity starts up, though, it first loads up the `TextView`. What goes in there depends on how the activity was launched:

1. If it was launched via the launcher (e.g., the action is `MAIN`), then we display in the `TextView` the `intent: URL` shown in the previous section, generated from an `Intent` object designed to trigger our fourth `<intent-filter>`. This also gets dumped to `LogCat`, and is how the author got this URL in the first place to put on the sample Web page of links.
2. If it was not launched via the launcher, it was launched from a Web link. If the `Uri` from the launching `Intent` is `null`, though, that means the activity was launched via the custom `intent: URL` (which only has an action string), so we put a message in the `TextView` to match.
3. Otherwise, the `Uri` from the launching `Intent` will have something we can use to process the link request. For the PDF file, it will be the local path to the downloaded PDF, so we can open it. For the `www.this-so-does-not-exist.com` URL, it will be the URL itself, so we can process it our own way.

Note that for the PDF case, clicking the PDF link in the Browser will download the file in the background, with a `Notification` indicating when it is complete. Tapping on the entry in the notification drawer will then trigger the `URLHandler` activity.

Also, bear in mind that the device may have multiple handlers for some URLs. For example, a device with a real PDF viewer will give the user a choice of whether to launch the downloaded PDF in the real view or `URLHandler`.



# Plugin Patterns

---

Plugins have historically been a popular model for extending the functionality of a base application. Browsers, for example, have long used plugins for everything from playing Flash animations to displaying calendars.

While Android does not have a specific “plugin framework”, many techniques exist in Android to create plugins. Which of these patterns is appropriate for you will depend upon the nature of the host application and, more importantly, on the nature of the plugin. This chapter will explore some of these plugin patterns.

## Plugins by Remote

Many a developer has sought to implement some sort of plugin mechanism on Android, whereby a base app can be extended with plugins that extend that app’s functionality, yet remain independent in terms of potential authorship.

The biggest challenge with such plugins comes at the UI level. While there are many ways to integrate applications for background work (remote services, broadcast Intents, etc.), blending user interfaces is a problem. It is unsafe to have an application execute some plugin’s code in its own process, as the plugin may be malicious in nature. Yet, the plugin cannot directly add widgets to the host app’s activities any other way.

The key word in that last sentence, of course, is “directly”.

There is an indirect way of having one app supply UI components to another app. We have seen it in action earlier in this book, in the form of home screen app widgets. That is the RemoteViews object. The plugin can create a RemoteViews

structure describing the desired UI and deliver that `RemoteViews` to the host app, which can then render that `RemoteViews` wherever it is needed.

This section will outline some of the mechanics behind creating such a plugin mechanism.

### RemoteViews, Beyond App Widgets

`RemoteViews` are used in a few other places besides app widgets, such as custom Notification views. However, you can use `RemoteViews` yourself easily enough. You create one as you would for any other circumstance, like an app widget. To display one, you can use the `apply()` method on the `RemoteViews` object. The `apply()` method takes two parameters:

1. Your Context, typically your Activity
2. The container into which the contents of the `RemoteViews` will eventually reside

The `apply()` method returns the View specified by the rules poured into the `RemoteViews` object... but it does not add it to the container specified in that second parameter. Hence, `apply()` is a bit like calling the three-parameter `inflate()` on a `LayoutInflater` and passing `false` for the third parameter — you are still responsible for actually adding the View to the parent when appropriate.

And that's pretty much it.

Since a `RemoteViews` object implements the `Parcelable` interface, you can store a `RemoteViews` in an Intent extra, a `Bundle`, or anything else that works with `Parcelable` (e.g., AIDL-defined remote service interfaces). This is what makes `RemoteViews` so valuable – you can pass one to another process, which can `apply()` it to its own UI.

As a result, `RemoteViews` are a secure way for a plugin to contribute to some host activity's UI. In fact, you can think of an app widget as being a “plugin” for the UI of the home screen.

### Thinking About Plugins

So, what does a plugin implementation need?

## PLUGIN PATTERNS

---

You have one application (the host) that will be able to display the RemoteViews supplied by other applications (the plugins). Somehow, the host will need to know:

1. What plugins are installed
2. How to get RemoteViews from the plugins to the host
3. Whether there are plugins that are installed that the user does not want (e.g., app widgets not added to the home screen) or if the user wants to see multiple RemoteViews from the same plugin (e.g., multiple instances of an app widget)

There are any number of ways of implementing these. The sample shown below will use a broadcast Intent to find plugins and another broadcast Intent to retrieve RemoteViews on demand, while assuming that each plugin will deliver exactly one RemoteViews.

Similarly, the plugin will need to know:

1. How it will be activated by the host
2. How it is supposed to deliver RemoteViews to the host (broadcast Intent? remote service API? something else?)
3. When it is supposed to deliver RemoteViews to the host (pulled by the host? pushed to the host? both?)
4. How many distinct instances of the plugin does the user want (e.g., multiple instances of the app widget), and what is the configuration data for each instance that makes one distinct from the next?

In the sample shown below, the plugin will respond to a broadcast Intent from the host with a broadcast of its own, signaling that it wishes to serve as a plugin. When the host sends a broadcast to retrieve the RemoteViews, the plugin will send a broadcast in response that contains the RemoteViews. And, to keep things simple, each plugin will only have one instance (and we will only have one plugin).

### A Sample Implementation

Let's take a look at the [RemoteViews/Host](#) and [RemoteViews/Plugin](#) sample applications. These are two apps, each in their own package, implementing a host/plugin relationship, with RemoteViews being generated by the plugin and displayed by the host.



### Finding Available Plugins

Our host is a simple activity containing a `TextView` as its only content. The expectation is that when the user chooses a Refresh options menu item, we will pull a `RemoteViews` from the plugin and display it.

That, of course, assumes that we have a plugin.

To find plugins, we will send a broadcast, with a custom action, `ACTION_CALL_FOR_PLUGINS`. Any plugin implementation would need a `BroadcastReceiver` set up in the manifest to respond to such an action.

To keep things simple, the host will only have one plugin. The plugin itself will be represented by a `ComponentName` object, identifying the implementation of the plugin, held in a `pluginCN` data member:

```
private ComponentName pluginCN=null;
```

In `onResume()`, if we do not have a plugin yet, we send the broadcast to try to find one:

```
@Override
public void onResume() {
    super.onResume();

    IntentFilter pluginFilter=new IntentFilter();

    pluginFilter.addAction(ACTION_REGISTER_PLUGIN);
    pluginFilter.addAction(ACTION_DELIVER_CONTENT);

    registerReceiver(plugin, pluginFilter, PERM_ACT_AS_PLUGIN, null);

    if (pluginCN == null) {
        sendBroadcast(new Intent(ACTION_CALL_FOR_PLUGINS));
    }
}
```

### Responding to the Call for Plugins

Over in our plugin implementation, we do indeed have a `BroadcastReceiver` — cunningly named `Plugin` — with a manifest entry set up to respond to our `ACTION_CALL_FOR_PLUGINS` broadcast.

What the host wants in response is to receive a broadcast from the plugin, with an action of `ACTION_REGISTER_PLUGIN`, and an extra of `EXTRA_COMPONENT`, containing the

## PLUGIN PATTERNS

---

ComponentName of the BroadcastReceiver that is the plugin implementation. So, when Plugin receives an ACTION\_CALL\_FOR\_PLUGINS broadcast, it does just that:

```
package com.commonware.android.rv.plugin;

import android.content.BroadcastReceiver;
import android.content.ComponentName;
import android.content.Context;
import android.content.Intent;
import android.widget.RemoteViews;

public class Plugin extends BroadcastReceiver {
    public static final String ACTION_CALL_FOR_PLUGINS=
        "com.commonware.android.rv.host.CALL_FOR_PLUGINS";
    public static final String ACTION_REGISTER_PLUGIN=
        "com.commonware.android.rv.host.REGISTER_PLUGIN";
    public static final String ACTION_CALL_FOR_CONTENT=
        "com.commonware.android.rv.host.CALL_FOR_CONTENT";
    public static final String ACTION_DELIVER_CONTENT=
        "com.commonware.android.rv.host.DELIVER_CONTENT";
    public static final String EXTRA_COMPONENT="component";
    public static final String EXTRA_CONTENT="content";
    private static final String HOST_PACKAGE="com.commonware.android.rv.host";

    @Override
    public void onReceive(Context ctxt, Intent i) {
        if (ACTION_CALL_FOR_PLUGINS.equals(i.getAction())) {
            Intent registration=new Intent(ACTION_REGISTER_PLUGIN);

            registration.setPackage(HOST_PACKAGE);
            registration.putExtra(EXTRA_COMPONENT,
                new ComponentName(ctxt, getClass()));

            ctxt.sendBroadcast(registration);
        }
        else if (ACTION_CALL_FOR_CONTENT.equals(i.getAction())) {
            RemoteViews rv=
                new RemoteViews(ctxt.getPackageName(), R.layout.plugin);
            Intent update=new Intent(ACTION_DELIVER_CONTENT);

            update.setPackage(HOST_PACKAGE);
            update.putExtra(EXTRA_CONTENT, rv);
            ctxt.sendBroadcast(update);
        }
    }
}
```

For added security, we use setPackage() in the plugin, so the ACTION\_REGISTER\_PLUGIN broadcast can only be received by the host.

## PLUGIN PATTERNS

---

The host activity needs to receive ACTION\_REGISTER\_PLUGIN broadcasts. Hence, it has a BroadcastReceiver implementation, in the plugin data member, that it registers for ACTION\_REGISTER\_PLUGIN in onResume(). The plugin BroadcastReceiver, upon receiving an ACTION\_REGISTER\_PLUGIN broadcast, grabs the ComponentName out of the EXTRA\_COMPONENT extra and stores it in pluginCN:

```
private BroadcastReceiver plugin=new BroadcastReceiver() {
    @Override
    public void onReceive(Context ctxt, Intent i) {
        if (ACTION_REGISTER_PLUGIN.equals(i.getAction())) {
            pluginCN=(ComponentName)i.getParcelableExtra(EXTRA_COMPONENT);
        }
        else if (ACTION_DELIVER_CONTENT.equals(i.getAction())) {
            RemoteViews rv=(RemoteViews)i.getParcelableExtra(EXTRA_CONTENT);
            ViewGroup frame=(ViewGroup)findViewById(android.R.id.content);

            frame.removeAllViews();

            View pluginView=rv.apply(RemoteViewsHostActivity.this, frame);

            frame.addView(pluginView);
        }
    }
};
```

At this point, we wait for the user to click the Refresh options menu item.

### Requesting RemoteViews

When the user does indeed choose Refresh, we call a refreshPlugin() method on the host activity:

```
private void refreshPlugin() {
    Intent call=new Intent(ACTION_CALL_FOR_CONTENT);

    call.setComponent(pluginCN);
    sendBroadcast(call);
}
```

Here, we send an ACTION\_CALL\_FOR\_CONTENT broadcast, with the target component set to be the plugin implementation, as identified by its ComponentName. This ensures that this broadcast will only go to that plugin app and nobody else.

### Responding with RemoteViews

Our Plugin is also registered in the manifest to respond to `ACTION_CALL_FOR_CONTENT`. So, when that broadcast arrives, it can create the `RemoteViews` in response, sending it out via an `ACTION_DELIVER_CONTENT` broadcast back to the host. Once again, we use `setPackage()` to restrict the broadcast to be the host's package. The broadcast also has the `RemoteViews` tucked in an `EXTRA_CONTENT` extra.

Our host activity registered the plugin `BroadcastReceiver` for `ACTION_DELIVER_CONTENT` as well. So, when that broadcast arrives, it can utilize the `RemoteViews`. We find the `ViewGroup` that is the root of our content (`android.R.id.content`), wipe out whatever is in it now, `apply()` the `RemoteViews` to that `ViewGroup`, and add the resulting `View` to the `ViewGroup`. This has the net effect of getting rid of our original `TextView` content, replacing it with whatever the plugin poured into the `RemoteViews`. Or, if the user chooses Refresh again, the older `RemoteViews`-generated content is replaced with fresh content.

### Dealing with Android 3.1+

To test this, install the Host application, followed by the Plugin application. On Android 3.0 and older, running the Host and choosing the Refresh options menu item will change the display from its original state to the one with the plugin's `RemoteViews`.

However, that will not work right away on Android 3.1 and higher.

On these versions of Android, applications are installed into a “stopped” state, where no `BroadcastReceiver` in the manifest will work, until the user manually runs the application. The simplest way to do that is via an activity. So, the Plugin project has a trivial activity that just displays a `Toast` and exits:

```
package com.commonware.android.rv.plugin;

import android.app.Activity;
import android.os.Bundle;
import android.widget.Toast;

public class PluginActivationActivity extends Activity {
    @Override
    public void onCreate(Bundle icle) {
        super.onCreate(icle);
    }
}
```

## PLUGIN PATTERNS

---

```
    Toast.makeText(this, R.string.activated, Toast.LENGTH_LONG).show();
    finish();
}
}
```

You will need to run this activity on Android 3.1 and higher first, then run the Host project's activity, to get the plugin to work.

If you happen to install these on an Android 3.0 or older device, though, you may wonder if the author has lost his marbles. That is because you will not see any activity associated with the Plugin application.

Since the author has not owned marbles in a few decades, clearly there must be some other answer. In this case, we use a variation of a trick pointed out by Daniel Lew.

Our `<activity>` element in the manifest has an `android:enabled` attribute. A disabled activity does not show up in the launcher. But rather than have `android:enabled` specifically tied to true or false in the manifest, it references a boolean resource:

```
<?xml version="1.0" encoding="utf-8"?>
<manifest xmlns:android="http://schemas.android.com/apk/res/android"
    package="com.commonware.android.rv.plugin"
    android:versionCode="1"
    android:versionName="1.0">

    <uses-sdk android:minSdkVersion="7"/>

    <uses-permission android:name="com.commonware.android.rv.host.ACT_AS_PLUGIN"/>

    <application
        android:icon="@drawable/ic_launcher"
        android:label="@string/app_name">
        <receiver
            android:name="Plugin"
            android:permission="com.commonware.android.rv.host.ACT_AS_HOST">
            <intent-filter>
                <action android:name="com.commonware.android.rv.host.CALL_FOR_PLUGINS"/>
                <action android:name="com.commonware.android.rv.host.CALL_FOR_CONTENT"/>
            </intent-filter>
        </receiver>

        <activity
            android:name="PluginActivationActivity"
            android:enabled="@bool/i_has_needs_activity"
            android:excludeFromRecents="true"
            android:theme="@android:style/Theme.NoDisplay">
            <intent-filter>
```

## PLUGIN PATTERNS

---

```
<action android:name="android.intent.action.MAIN"/>
    <category android:name="android.intent.category.LAUNCHER"/>
</intent-filter>
</activity>
</application>
</manifest>
```

In `res/values/bools.xml`, we define that boolean resource to be false, meaning the activity will not appear in the launcher:

```
<resources>
    <bool name="i_has_needs_activity">false</bool>
</resources>
```

But, in `res/values-v12/bools.xml`, we define that boolean resource to be true, causing the activity to appear on Android 3.1 and higher:

```
<resources>
    <bool name="i_has_needs_activity">true</bool>
</resources>
```

This way, our extraneous activity does not clutter up older devices where it is not needed. [Mr. Lew's blog post](#) on this subject points out that this trick can be used to have different implementations of an app widget for different Android versions (e.g., one that uses a `ListView` for API Level 11 and higher, plus one that does not for older devices).

### The Permission Scheme

Another thing that these sample projects use are custom permissions, to help with security.

To serve as a plugin host, you must hold the `ACTS_AS_HOST` permission. To serve as a plugin implementation, you must hold the `ACTS_AS_PLUGIN` permission. These are defined in the Host project's manifest:

```
<permission
    android:name="com.commonware.android.rv.host.ACT_AS_HOST"
    android:description="@string/host_desc"
    android:label="@string/host_label">
```

## PLUGIN PATTERNS

---

```
</permission>
<permission
  android:name="com.commonware.android.rv.host.ACT_AS_PLUGIN"
  android:description="@string/plugin_desc"
  android:label="@string/plugin_label">
</permission>
```

Each application then has its appropriate `<uses-permission>` element for the role that it plays, such as the Plugin holding the ACTS\_AS\_PLUGIN permission:

```
<uses-permission android:name="com.commonware.android.rv.host.ACT_AS_PLUGIN"/>
```

The BroadcastReceiver defined by the Plugin project has, in its `<receiver>` element, the `android:permission` attribute, indicating that whoever sends a broadcast to this receiver must hold ACTS\_AS\_HOST:

```
<receiver
  android:name="Plugin"
  android:permission="com.commonware.android.rv.host.ACT_AS_HOST">
  <intent-filter>
    <action android:name="com.commonware.android.rv.host.CALL_FOR_PLUGINS"/>
    <action android:name="com.commonware.android.rv.host.CALL_FOR_CONTENT"/>
  </intent-filter>
</receiver>
```

Similarly, the BroadcastReceiver defined dynamically by the host activity uses a version of `registerReceiver()` that takes the permission the sender must hold:

```
registerReceiver(plugin, pluginFilter, PERM_ACT_AS_PLUGIN, null);
```

That permission is defined in a static data member:

```
public static final String PERM_ACT_AS_PLUGIN=
  "com.commonware.android.rv.host.ACT_AS_PLUGIN";
```

This way, the user is informed about the host/plugin relationship and can make appropriate decisions when they install plugins.

Note, though, that for this to work, the host application must be installed first, to define the custom permissions. If a plugin is installed before the host, there is no error, but the plugin will not be granted the as-yet-undefined custom permissions, and so the plugin will not work. The user would have to uninstall and reinstall the plugin after installing the host to fix this problem.

### Other Plugin Features and Issues

It is possible for the `apply()` method on `RemoteViews` to throw a `RuntimeException`. For example, the `RemoteViews` might contain a reference to a widget ID that does not exist within the inflated views of the `RemoteViews` itself. Since `apply()` does not throw a checked exception, it is easy to do what we did in the sample app and assume `apply()` will succeed, but it very well may not. A robust implementation of this plugin system would wrap the `apply()` call in an exception handler that would do something useful if the plugin's `RemoteViews` has a bug.

You need to be a bit careful to make sure that a plugin can only update itself. The sample app assumes that the only thing that will send an `ACTION_DELIVER_CONTENT` broadcast to it will be the plugin, but that is not necessarily the case. In principle, anything that holds the `ACTS_AS_PLUGIN` permission could send an `ACTION_DELIVER_CONTENT` to the host, and thereby specify what the `RemoteViews` are. A robust plugin system would have some sort of shared secret, such as an identifier, between the host and the plugin, so another component cannot readily masquerade as being the plugin itself.

### ContentProvider Plugins

Another way to extend your application at runtime is via plugins implemented via the `ContentProvider` framework. You could create new `ContentProvider` implementations that offer up data, perhaps using a consistent schema. Then, you could find those providers via a naming convention (e.g., for a main application with a package of `com.foo.abc`, your plugin apps would be `com.foo.abc.plugin.*`) and `PackageManager`, perhaps using a `provider Uri` naming convention to allow the host to know how to query the plugin.

However, there are other ways of employing a `ContentProvider` to help as a plugin, and this section explores one specific scenario: reducing the host app's permission requirements.

### The Problem: Permission Creep

At the moment, for standard versions of Android, apps cannot request “conditional” or “optional” permissions, that the user could elect to opt out of. Instead, apps must request in their manifest all possible permissions that they could need. This is considered by many to be a significant limitation, but Google has stated repeatedly that they are not considering alternative strategies.



The net effect, though, is that an app often times needs a lot of permissions, or needs to add new permissions (requiring existing users to agree to the new permission list). Such lists of permissions can dissuade potential users from installing the app in the first place.

However, even though Android does not provide a simple and clean way for users to opt into (or out of) certain permissions for certain apps, plugins can offer a similar model. The base app can require some permissions for some features, with other features (and their respective permissions) added via plugins. Users can elect to install the plugins and agree to those permissions, or abandon or never install the plugins in the first place.

The hassle, of course, is in implementing the plugin APK and connecting to it from the main app. The plugin needs to have all the functionality that must directly use classes and methods secured by the permission. This can increase the complexity in maintaining the overall app.

### **A Solution: ContentProvider Proxies**

Some permissions exist primarily to protect a ContentProvider, such as `READ_CONTACTS` and `WRITE_CONTACTS` for the `ContactsContract` provider.

The nice thing about the ContentProvider framework is that it is simply a contract. You use a `ContentResolver` and some magic values (`Uri`, “projection” of columns to return, etc.), and you get results. In fact, you can even change some of those magic values – any `Uri` supporting the same columns could be used with all the same client Java code, just by changing the `Uri` itself.

That allows us to create a proxy for ContentProvider. The proxy APK will hold the permission and call the real ContentProvider as needed. The proxy APK will expose its own ContentProvider, with a different `Uri`. Done properly — such that only the host app can use the proxy — the proxy will isolate the permission(s) for the real ContentProvider in the plugin. A `ContactsContract` proxy, for example, could hold `READ_CONTACTS` and `WRITE_CONTACTS`, proxying requests on behalf of a main app that lacks those permissions.

To secure the proxy, we need to ensure that only our apps can use the proxy, not anyone else’s apps. Otherwise, those third-party apps could get at, say, contacts without the `READ_CONTACTS` permission.

The simplest way to accomplish this is to use a signature-level custom permission.

Any app can declare a new permission via the `<permission>` element in the manifest. Normally, any app can request to hold this permission via `<uses-permission>`, and the user will be able to grant or deny this request at install time, just like any system-defined permission.

However, it is possible to add an `android:protectionLevel="signature"` attribute to the `<permission>` element. In this case, only apps signed by the same signing key will be able to request the permission — everyone else is automatically denied. Furthermore, apps signed by the same signing key will automatically get the permission without the user having to approve it.

So, you can have the proxy require a signature-level custom permission, thereby limiting possible consumers of the proxy to be signed by the same signing key.

### Examining a Sample

Let's look at a pair of projects that create and consume a proxy for the CallLog ContentProvider. These projects are located in the Introspection/CppProxy directory and are named [Provider](#) and [Consumer](#), respectively.

#### Provider

Most of the logic for our provider proxy can be found in the `AbstractCPPProxy` base class. It implements the mandatory methods for the ContentProvider contract — such as `insert()` — and simply turns around and forwards those requests along to another provider:

```
package com.commonware.android.cpproxy.provider;

import android.content.ContentProvider;
import android.content.ContentValues;
import android.database.CrossProcessCursor;
import android.database.Cursor;
import android.database.CursorWindow;
import android.database.CursorWrapper;
import android.net.Uri;

public abstract class AbstractCPPProxy extends ContentProvider {
    abstract protected Uri convertUri(Uri uri);

    public AbstractCPPProxy() {
        super();
    }

    @Override
```

## PLUGIN PATTERNS

---

```
public boolean onCreate() {
    return(true);
}

@Override
public Cursor query(Uri uri, String[] projection, String selection,
    String[] selectionArgs, String sortOrder) {
    Cursor result=
        getContext().getContentResolver().query(convertUri(uri),
            projection, selection,
            selectionArgs,
            sortOrder);

    return(new CrossProcessCursorWrapper(result));
}

@Override
public Uri insert(Uri uri, ContentValues values) {
    return(getContext().getContentResolver().insert(convertUri(uri),
        values));
}

@Override
public int update(Uri uri, ContentValues values, String selection,
    String[] selectionArgs) {
    return(getContext().getContentResolver().update(convertUri(uri),
        values, selection,
        selectionArgs));
}

@Override
public int delete(Uri uri, String selection, String[] selectionArgs) {
    return(getContext().getContentResolver().delete(convertUri(uri),
        selection,
        selectionArgs));
}

@Override
public String getType(Uri uri) {
    return(getContext().getContentResolver().getType(convertUri(uri)));
}

// following from
// http://stackoverflow.com/a/5243978/115145

public class CrossProcessCursorWrapper extends CursorWrapper
    implements CrossProcessCursor {
    public CrossProcessCursorWrapper(Cursor cursor) {
        super(cursor);
    }

    @Override
    public CursorWindow getWindow() {
        return null;
    }
}
```

## PLUGIN PATTERNS

---

```
}

@Override
public void fillWindow(int position, CursorWindow window) {
    if (position < 0 || position > getCount()) {
        return;
    }
    window.acquireReference();
    try {
        moveToPosition(position - 1);
        window.clear();
        window.setStartPosition(position);
        int columnNum=getColumnCount();
        window.setNumColumns(columnNum);
        while (moveToNext() && window.allocRow()) {
            for (int i=0; i < columnNum; i++) {
                String field=getString(i);
                if (field != null) {
                    if (!window.putString(field, getPosition(), i)) {
                        window.freeLastRow();
                        break;
                    }
                }
                else {
                    if (!window.putNull(getPosition(), i)) {
                        window.freeLastRow();
                        break;
                    }
                }
            }
        }
    }
    catch (IllegalStateException e) {
        // simply ignore it
    }
    finally {
        window.releaseReference();
    }
}

@Override
public boolean onMove(int oldPosition, int newPosition) {
    return true;
}
}
```

It is up to a subclass of `AbstractCProxy` to implement the `convertUri()` method, which takes the `Uri` supplied by the consumer and transforms it into the proper `Uri` to use for making the real request. In this case, our subclass is `CallLogProxy`:

```
package com.commonware.android.cproxy.provider;
```

---

## PLUGIN PATTERNS

---

```
import android.content.ContentUris;
import android.net.Uri;
import android.provider.CallLog;

public class CallLogProxy extends AbstractCPPProxy {
    protected Uri convertUri(Uri uri) {
        long id=ContentUris.parseId(uri);

        if (id >= 0) {
            return(ContentUris.withAppendedId(CallLog.Calls.CONTENT_URI, id));
        }

        return(CallLog.Calls.CONTENT_URI);
    }
}
```

Here, we grab the instance ID off the end of the Uri (if it exists) and generate a new Uri based on CallLog.CONTENT\_URI, indicating that we want to forward our requests to the CallLog.

The biggest complexity of the standard CRUD ContentProvider methods comes with query(). The Cursor returned by query() must implement the CrossProcessCursor interface. The SQLiteCursor implementation supports this interface, which is why typical providers do not worry about this requirement. However, the Cursor returned by query() on ContentResolver is not necessarily a CrossProcessCursor. Hence, we need to wrap it in a CursorWrapper that does implement CrossProcessCursor:

```
@Override
public Cursor query(Uri uri, String[] projection, String selection,
    String[] selectionArgs, String sortOrder) {
    Cursor result=
        getContext().getContentResolver().query(convertUri(uri),
            projection, selection,
            selectionArgs,
            sortOrder);

    return(new CrossProcessCursorWrapper(result));
}
```

The resulting CrossProcessCursorWrapper, as originally shown in [a StackOverflow answer](#), looks like this:

```
// following from
// http://stackoverflow.com/a/5243978/115145

public class CrossProcessCursorWrapper extends CursorWrapper
    implements CrossProcessCursor {
    public CrossProcessCursorWrapper(Cursor cursor) {
```

## PLUGIN PATTERNS

---

```
    super(cursor);
}

@Override
public CursorWindow getWindow() {
    return null;
}

@Override
public void fillWindow(int position, CursorWindow window) {
    if (position < 0 || position > getCount()) {
        return;
    }
    window.acquireReference();
    try {
        moveToPosition(position - 1);
        window.clear();
        window.setStartPosition(position);
        int columnNum=getColumnCount();
        window.setNumColumns(columnNum);
        while (moveToNext() && window.allocRow()) {
            for (int i=0; i < columnNum; i++) {
                String field=getString(i);
                if (field != null) {
                    if (!window.putString(field, getPosition(), i)) {
                        window.freeLastRow();
                        break;
                    }
                }
                else {
                    if (!window.putNull(getPosition(), i)) {
                        window.freeLastRow();
                        break;
                    }
                }
            }
        }
    }
    catch (IllegalStateException e) {
        // simply ignore it
    }
    finally {
        window.releaseReference();
    }
}

@Override
public boolean onMove(int oldPosition, int newPosition) {
    return true;
}
}
```

## PLUGIN PATTERNS

---

Note that this implementation has been largely untested by this book's author, though it appears to work.

The manifest for this project has three items of note:

- It has the `<uses-permission>` element for `READ_CONTACTS`, while our consumer project will not
- It has a `<permission>` element, defining a custom `com.commonware.android.cproxy.PLUGIN` permission that has signature-level protection
- It has our `<provider>`, requiring that custom permission, and declaring its authority to be `com.commonware.android.cproxy.CALL_LOG`

```
<?xml version="1.0" encoding="utf-8"?>
<manifest xmlns:android="http://schemas.android.com/apk/res/android"
  package="com.commonware.android.cproxy.provider"
  android:versionCode="1"
  android:versionName="1.0">

  <uses-sdk
    android:minSdkVersion="7"
    android:targetSdkVersion="11"/>

  <uses-permission android:name="android.permission.READ_CONTACTS"/>
  <uses-permission android:name="com.commonware.android.cproxy.PLUGIN"/>

  <permission
    android:name="com.commonware.android.cproxy.PLUGIN"
    android:protectionLevel="signature">
  </permission>

  <application
    android:icon="@drawable/ic_launcher"
    android:label="@string/app_name">
    <provider
      android:name=".CallLogProxy"
      android:authorities="com.commonware.android.cproxy.CALL_LOG"
      android:permission="com.commonware.android.cproxy.PLUGIN">
    </provider>
  </application>
</manifest>
```

Note that a complete `AbstractCPProxy` implementation should forward along all the other methods as well (e.g., `call()`).

### Consumer

Our Consumer project is nearly identical to the CalendarContract sample [from elsewhere in this book](#).

However, instead of the READ\_CONTACTS permission, we declare that we need the com.commonware.android.cproxy.PLUGIN permission instead:

```
<?xml version="1.0" encoding="utf-8"?>
<manifest xmlns:android="http://schemas.android.com/apk/res/android"
    package="com.commonware.android.cproxy.consumer"
    android:versionCode="1"
    android:versionName="1.0">

    <uses-sdk
        android:minSdkVersion="7"
        android:targetSdkVersion="11"/>

    <uses-permission android:name="com.commonware.android.cproxy.PLUGIN"/>

    <permission
        android:name="com.commonware.android.cproxy.PLUGIN"
        android:protectionLevel="signature">
    </permission>

    <application
        android:icon="@drawable/ic_launcher"
        android:label="@string/app_name">
        <activity
            android:name=".CProxyConsumerActivity"
            android:label="@string/app_name">
            <intent-filter>
                <action android:name="android.intent.action.MAIN"/>

                <category android:name="android.intent.category.LAUNCHER"/>
            </intent-filter>
        </activity>
    </application>
</manifest>
```

Also, our CONTENT\_URI is no longer the one found on CallLog, but rather one identifying our proxy:

```
private static final Uri CONTENT_URI=
    Uri.parse("content://com.commonware.android.cproxy.CALL_LOG");
```

And there are minor changes because we are querying CallLog (indirectly) rather than CalendarContract, such as a change in the columns for our projection:



## PLUGIN PATTERNS

---

```
private static final String[] PROJECTION=new String[] {  
    CallLog.Calls._ID, CallLog.Calls.NUMBER, CallLog.Calls.DATE };
```

Otherwise, the consumer projects are the same. The difference is that our consumer project does not need the READ\_CONTACTS permission the same way that the original needed the READ\_CALENDAR permission.

In this case, the consumer project depends entirely upon the existence of the plugin — otherwise, the consumer project has no value. Hence, in this case, going the plugin route is silly. But an application that could use the CallLog but does not depend upon it could use this approach to isolate the READ\_CONTACTS requirement in a plugin, so users could elect to install the plugin or not, and the main app would not need to request READ\_CONTACTS and add to the roster of permissions the user must agree to up front.

### Limitations of the Approach

There will be additional overhead in using the proxy, which will hamper performance. Ideally, this plugin mechanism is only used for features that need light use of the protected ContentProvider, so the overhead will not be a burden to the user.

# PackageManager Tricks

---

`PackageManager` is your primary means of introspection at the component level, to determine what else is installed on the device and what components they export (activities, etc.). As such, there are many ways you can use `PackageManager` to determine if something you want is possible or not, so you can modify your behavior accordingly (e.g., disable action bar items that are not possible).

This chapter will outline some ways you can use `PackageManager` to find out what components are available to you on a device.

## Prerequisites

Understanding this chapter requires that you have read the core chapters of this book.

## Asking Around

The ways to find out whether there is an activity that will respond to a given `Intent` are by means of `queryIntentActivityOptions()` and the somewhat simpler `queryIntentActivities()`.

The `queryIntentActivityOptions()` method takes the caller `ComponentName`, the “specifics” array of `Intent` instances, the overall `Intent` representing the actions you are seeking, and the set of flags. It returns a `List` of `Intent` instances matching the stated criteria, with the “specifics” ones first.



## PACKAGEMANAGER TRICKS

---

```
@Override
protected void onItemClick(ListView l, View v,
                           int position, long id) {
    ResolveInfo launchable=adapter.getItem(position);
    ActivityInfo activity=launchable.activityInfo;
    ComponentName name=new ComponentName(activity.applicationInfo.packageName,
                                         activity.name);
    Intent i=new Intent(Intent.ACTION_MAIN);

    i.addCategory(Intent.CATEGORY_LAUNCHER);
    i.setFlags(Intent.FLAG_ACTIVITY_NEW_TASK |
              Intent.FLAG_ACTIVITY_RESET_TASK_IF_NEEDED);
    i.setComponent(name);

    startActivity(i);
}

class AppAdapter extends ArrayAdapter<ResolveInfo> {
    private PackageManager pm=null;

    AppAdapter(PackageManager pm, List<ResolveInfo> apps) {
        super(Launchalot.this, R.layout.row, apps);
        this.pm=pm;
    }

    @Override
    public View getView(int position, View convertView,
                       ViewGroup parent) {
        if (convertView==null) {
            convertView=newView(parent);
        }

        bindView(position, convertView);

        return(convertView);
    }

    private View newView(ViewGroup parent) {
        return(getLayoutInflater().inflate(R.layout.row, parent, false));
    }

    private void bindView(int position, View row) {
        TextView label=(TextView)row.findViewById(R.id.label);

        label.setText(getItem(position).loadLabel(pm));

        ImageView icon=(ImageView)row.findViewById(R.id.icon);

        icon.setImageDrawable(getItem(position).loadIcon(pm));
    }
}
}
```

In onCreate(), we:

## PACKAGEMANAGER TRICKS

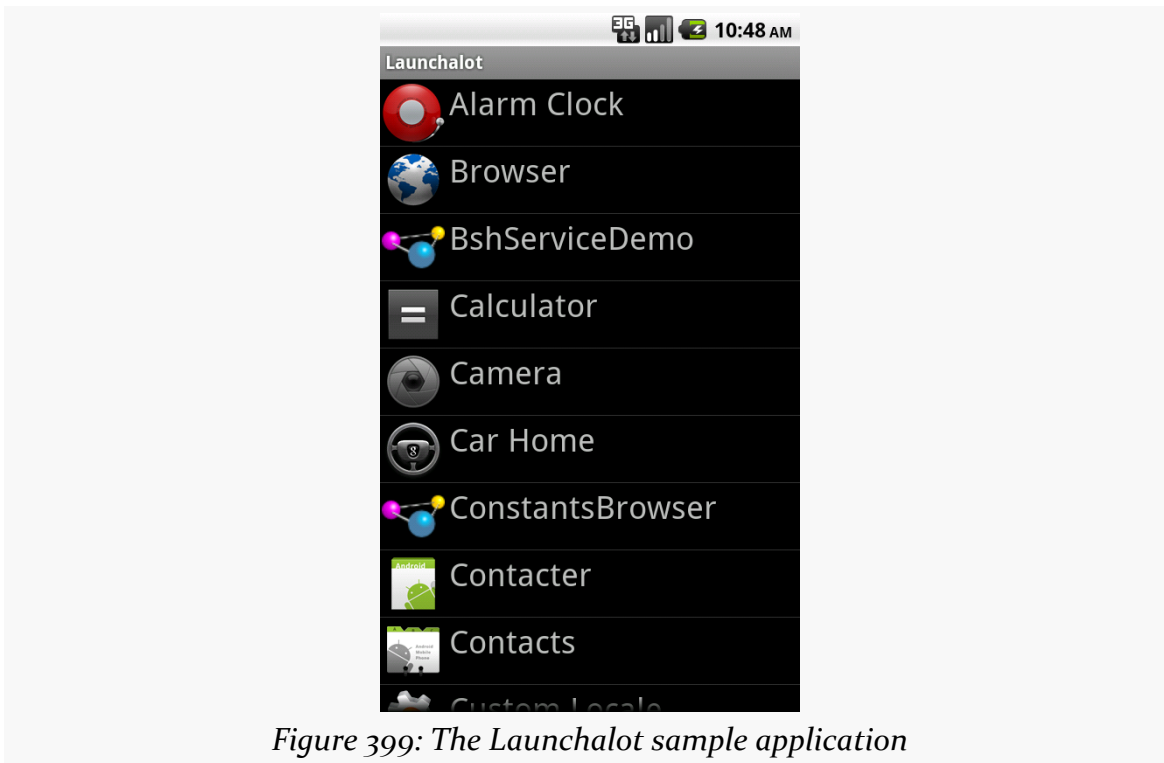
---

1. Get a PackageManager object via `getPackageManager()`
2. Create an Intent for ACTION\_MAIN in CATEGORY\_LAUNCHER, which identifies activities that wish to be considered “launchable”
3. Call `queryIntentActivities()` to get a List of ResolveInfo objects, each one representing one launchable activity
4. Sort those ResolveInfo objects via a `ResolveInfo.DisplayNameComparator` instance
5. Pour them into a custom AppAdapter and set that to be the contents of our ListView

AppAdapter is an ArrayAdapter subclass that maps the icon and name of the launchable Activity to a row in the ListView, using a custom row layout.

Finally, in `onListItemClick()`, we construct an Intent that will launch the clicked-upon Activity, given the information from the corresponding ResolveInfo object. Not only do we need to populate the Intent with ACTION\_MAIN and CATEGORY\_LAUNCHER, but we also need to set the component to be the desired Activity. We also set FLAG\_ACTIVITY\_NEW\_TASK and FLAG\_ACTIVITY\_RESET\_TASK\_IF\_NEEDED flags, following Android’s own launcher implementation from the Home sample project. Finally, we call `startActivity()` with that Intent, which opens up the activity selected by the user.

The result is a simple list of launchable activities:



There is also a `resolveActivity()` method that takes a template Intent, as do `queryIntentActivities()` and `queryIntentActivityOptions()`. However, `resolveActivity()` returns the single best match, rather than a list.

## Preferred Activities

Users, when presented with a default activity chooser, usually have the option to check a `CheckBox` indicating that they want to make their next choice be the default for this action for now on. The next time they do whatever they did to bring up the chooser, it should go straight to this default. This is known in the system as the “preferred activity” for an Intent structure, and is stored in the system as a set of pairs of `IntentFilter` objects and the corresponding `ComponentName` of the preferred activity.

To find out what the preferred activities are on a given device, you can ask `PackageManager` to `getPreferredActivities()`. You pass in a `List<IntentFilter>` and a `List<ComponentName>`, and Android fills in those lists with the preferred activity information.

---

## PACKAGEMANAGER TRICKS

---

To see this in action, take a look at the [Introspection/PrefActivities](#) sample application. This simply loads all of the information into a `ListView`, using `android.R.layout.simple_list_item_2` as a row layout for a title-and-description pattern.

The `PackageManager` logic is confined to `onCreate()`:

```
@Override
public void onCreate(Bundle savedInstanceState) {
    super.onCreate(savedInstanceState);

    PackageManager mgr=getPackageManager();

    mgr.getPreferredActivities(filters, names, null);
    setListAdapter(new IntentFilterAdapter());
}
```

In this case, the two lists are data members of the activity:

```
ArrayList<IntentFilter> filters=new ArrayList<IntentFilter>();
ArrayList<ComponentName> names=new ArrayList<ComponentName>();
```

Most of the logic is in formatting the `ListView` contents. `IntentFilter`, unfortunately, does not come with a method that gives us a human-readable dump of its definition. As a result, we need to roll that ourselves. Compounding the problem is that `IntentFilter` tends to return `Iterator` objects for its collections (e.g., roster of actions), rather than something `Iterable`. The activity leverages an `Iterator-to-Iterable` wrapper culled from [a StackOverflow answer](#) to help with this. The `IntentFilterAdapter` and helper code looks like this:

```
// from http://stackoverflow.com/a/8555153/115145

public static <T> Iterable<T> in(final Iterator<T> iterator) {
    class SingleUseIterable implements Iterable<T> {
        private boolean used=false;

        @Override
        public Iterator<T> iterator() {
            if (used) {
                throw new IllegalStateException("Already invoked");
            }
            used=true;
            return iterator;
        }
    }
    return new SingleUseIterable();
}
```

## PACKAGEMANAGER TRICKS

---

```
class IntentFilterAdapter extends ArrayAdapter<IntentFilter> {
    IntentFilterAdapter() {
        super(PreferredActivitiesDemoActivity.this,
            android.R.layout.simple_list_item_2, android.R.id.text1,
            filters);
    }

    @Override
    public View getView(int position, View convertView, ViewGroup parent) {
        View row=super.getView(position, convertView, parent);
        TextView filter=(TextView)row.findViewById(android.R.id.text1);
        TextView name=(TextView)row.findViewById(android.R.id.text2);

        filter.setText(buildTitle(getItem(position)));
        name.setText(names.get(position).getClassName());

        return(row);
    }

    String buildTitle(IntentFilter filter) {
        StringBuilder buf=new StringBuilder();
        boolean first=true;

        if (filter.countActions() > 0) {
            for (String action : in(filter.actionsIterator())) {
                if (first) {
                    first=false;
                }
                else {
                    buf.append('/');
                }

                buf.append(action.replaceAll("android.intent.action.", ""));
            }
        }

        if (filter.countDataTypes() > 0) {
            first=true;

            for (String type : in(filter.typesIterator())) {
                if (first) {
                    buf.append(" : ");
                    first=false;
                }
                else {
                    buf.append('|');
                }

                buf.append(type);
            }
        }

        if (filter.countDataSchemes() > 0) {
            buf.append(" : ");
        }
    }
}
```



## PACKAGEMANAGER TRICKS

---

```
buf.append(filter.getDataScheme(0));

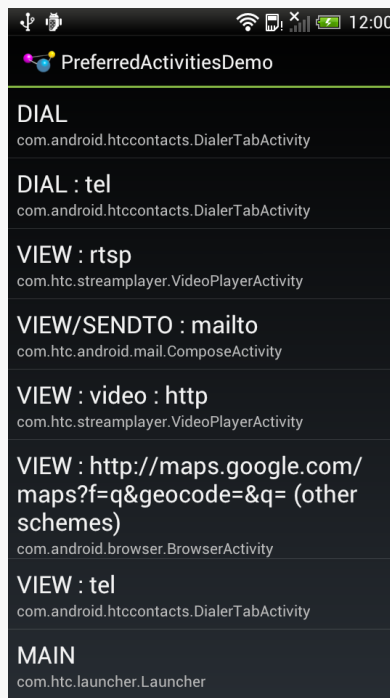
if (filter.countDataSchemes() > 1) {
    buf.append(" (other schemes)");
}

if (filter.countDataPaths() > 0) {
    buf.append(" : ");
    buf.append(filter.getDataPath(0));

    if (filter.countDataPaths() > 1) {
        buf.append(" (other paths)");
    }
}

return(buf.toString());
}
```

The resulting activity shows a simple description of the IntentFilter along with the class name of the corresponding activity in each row:



*Figure 400: Preferred Activities on a Stock HTC One S*

Another way to think about preferred activities is to determine what specific activity will handle a `startActivity()` call on some Intent. If there is only one alternative,

## PACKAGEMANAGER TRICKS

---

or the user chose a preferred activity, that activity should handle the Intent. Otherwise, the activity handling the Intent *should* be one implementing a chooser. The `resolveActivity()` method on `PackageManager` can let us know what will handle the Intent.

To examine what `resolveActivity()` returns, take a look at the [Introspection/Resolver](#) sample application.

The activity — which uses `Theme.NoDisplay` and so has no UI of its own — is fairly short:

```
package com.commonware.android.resolver;

import android.app.Activity;
import android.content.Intent;
import android.content.pm.PackageManager;
import android.content.pm.ResolveInfo;
import android.net.Uri;
import android.os.Bundle;
import android.widget.Toast;

public class ResolveActivityDemoActivity extends Activity {
    @Override
    public void onCreate(Bundle savedInstanceState) {
        super.onCreate(savedInstanceState);

        PackageManager mgr=getPackageManager();
        Intent i=
            new Intent(Intent.ACTION_VIEW,
                Uri.parse("http://commonware.com"));
        ResolveInfo ri=
            mgr.resolveActivity(i, PackageManager.MATCH_DEFAULT_ONLY);

        Toast.makeText(this, ri.loadLabel(mgr), Toast.LENGTH_LONG).show();

        startActivity(i);
        finish();
    }
}
```

We get a `PackageManager`, create an `Intent` to test, and pass the `Intent` to `resolveActivity()`. We include `MATCH_DEFAULT_ONLY` so we only get activities that have `CATEGORY_DEFAULT` in their `<intent-filter>` elements. We then use `loadLabel()` on the resulting `ResolveInfo` object to get the display name of the activity, toss that in a `Toast`, and invoke `startActivity()` on the `Intent` to confirm the results.

On a device with only one option, or with a default chosen, the Toast will show the name of the preferred activity (e.g., Browser). On most devices with more than one option, the `startActivity()` call will display a chooser, and the Toast will show the display name of the chooser (e.g., “Android System”).

However, on some devices — notably newer models from HTC distributed in the US — `resolveActivity()` indicates that `HTCLinkifyDispatcher` is the one that will handle `ACTION_VIEW` on a URL... even if there is more than one browser installed and no default has been specified. This is part of a workaround that HTC added in 2012 to help deal with a patent dispute with Apple.

## Middle Management

The `PackageManager` class offers much more than merely `queryIntentActivities()` and `queryIntentActivityOptions()`. It is your gateway to all sorts of analysis of what is installed and available on the device where your application is installed and available. If you want to be able to intelligently connect to third-party applications based on whether or not they are around, `PackageManager` is what you will want.

## Finding Applications and Packages

Packages are what get installed on the device — a package is the in-device representation of an APK. An application is defined within a package’s manifest. Between the two, you can find out all sorts of things about existing software installed on the device.

Specifically, `getInstalledPackages()` returns a List of `PackageInfo` objects, each of which describes a single package. Here, you can find out:

1. The version of the package, in terms of a monotonically increasing number (`versionCode`) and the display name (`versionName`)
2. Details about all of the components — activities, services, etc. — offered by this package
3. Details about the permissions the package requires

Similarly, `getInstalledApplications()` returns a List of `ApplicationInfo` objects, each providing data like:

1. The user ID that the application will run as
2. The path to the application’s private data directory

3. Whether or not the application is enabled

In addition to those methods, you can call:

1. `getApplicationIcon()` and `getApplicationLabel()` to get the icon and display name for an application
2. `getLaunchIntentForPackage()` to get an Intent for something launchable within a named package
3. `setApplicationEnabledSetting()` to enable or disable an application

### Finding Resources

You can access resources from another application, apparently without any security restrictions. This may be useful if you have multiple applications and wish to share resources for one reason or another.

The `getResourcesForActivity()` and `getResourcesForApplication()` methods on `PackageManager` return a `Resources` object. This is just like the one you get for your own application via `getResources()` on any `Context` (e.g., `Activity`). However, in this case, you identify what activity or application you wish to get the `Resources` from (e.g., supply the application's package name as a `String`).

There are also `getText()` and `getXml()` methods that dive into the `Resources` object for an application and pull out specific `String` or `XmlPullParser` objects. However, these require you to know the resource ID of the resource to be retrieved, and that may be difficult to manage between disparate applications.

### Finding Components

Not only does Android offer “query” and “resolve” methods to find activities, but it offers similar methods to find other sorts of Android components:

1. `queryBroadcastReceivers()`
2. `queryContentProviders()`
3. `queryIntentServices()`
4. `resolveContentProvider()`
5. `resolveService()`

For example, you could use `resolveService()` to determine if a certain remote service is available, so you can disable certain UI elements if the service is not on the

## PACKAGEMANAGER TRICKS

---

device. You could achieve the same end by calling `bindService()` and watching for a failure, but that may be later in the application flow than you would like.

There is also a `setComponentEnabledSetting()` to toggle a component (activity, service, etc.) on and off. While this may seem esoteric, there are a number of possible uses for this method, such as:

1. Flagging a launchable activity as disabled in your manifest, then enabling it programmatically after the user has entered a license key, achieved some level or standing in a game, or any other criteria
2. Controlling whether a `BroadcastReceiver` registered in the manifest is hooked into the system or not, replicating the level of control you have with `registerReceiver()` while still taking advantage of the fact that a manifest-registered `BroadcastReceiver` can be started even if no other component of your application is running

# Searching with SearchManager

---

One of the firms behind the Open Handset Alliance — Google — has a teeny weeny Web search service, one you might have heard of in passing. Given that, it's not surprising that Android has some amount of built-in search capabilities.

Specifically, Android has “baked in” the notion of searching not only on the device for data, but over the air to Internet sources of data.

Your applications can participate in the search process, by triggering searches or perhaps by allowing your application's data to be searched.

## Prerequisites

Understanding this chapter requires that you have read the chapters on:

- [content provider theory](#)
- [content provider implementations](#)

## Hunting Season

There are two types of search in Android: local and global. Local search searches within the current application; global search searches the Web via Google's search engine. You can initiate either type of search in a variety of ways, including:

1. You can call `onSearchRequested()` from a button or menu choice, which will initiate a local search (unless you override this method in your activity)
2. You can directly call `startSearch()` to initiate a local or global search, including optionally supplying a search string to use as a starting point

## SEARCHING WITH SEARCHMANAGER

---

3. You can elect to have keyboard entry kick off a search via `setDefaultKeyMode()`, for either local search (`setDefaultKeyMode(DEFAULT_KEYS_SEARCH_LOCAL)`) or global search (`setDefaultKeyMode(DEFAULT_KEYS_SEARCH_GLOBAL)`)

In either case, the search appears as a set of UI components across the top of the screen, with a suggestion list (where available) and IME (where needed).



*Figure 401: The Android local search popup, showing the IME and a previous search*



*Figure 402: The Android global search popup*

Where that search suggestion comes from for your local searches will be covered later in this chapter.

## Search Yourself

Over the long haul, there will be two flavors of search available via the Android search system:

- Query-style search, where the user's search string is passed to an activity which is responsible for conducting the search and displaying the results
- Filter-style search, where the user's search string is passed to an activity on every keypress, and the activity is responsible for updating a displayed list of matches

Since the latter approach is decidedly under-documented, let's focus on the first one.



## Craft the Search Activity

The first thing you are going to want to do if you want to support query-style search in your application is to create a search activity. While it might be possible to have a single activity be both opened from the launcher and opened from a search, that might prove somewhat confusing to users. Certainly, for the purposes of learning the techniques, having a separate activity is cleaner.

The search activity can have any look you want. In fact, other than watching for queries, a search activity looks, walks, and talks like any other activity in your system.

All the search activity needs to do differently is check the intents supplied to `onCreate()` (via `getIntent()`) and `onNewIntent()` to see if one is a search, and, if so, to do the search and display the results.

For example, let's look at the [Search/Lorem] sample application. This starts off as a version of the list-of-lorem-ipsum-words application seen in various places in this book. Now, we update it to support searching the list of words for ones containing the search string.

The main activity and the search activity both share a common layout: a `ListView` plus a `TextView` showing the selected entry:

```
<?xml version="1.0" encoding="utf-8"?>
<LinearLayout xmlns:android="http://schemas.android.com/apk/res/android"
    android:orientation="vertical"
    android:layout_width="match_parent"
    android:layout_height="match_parent" >
    <TextView
        android:id="@+id/selection"
        android:layout_width="match_parent"
        android:layout_height="wrap_content"
    />
    <ListView
        android:id="@android:id/list"
        android:layout_width="match_parent"
        android:layout_height="match_parent"
        android:drawSelectorOnTop="false"
    />
</LinearLayout>
```

In terms of Java code, most of the guts of the activities are poured into an abstract `LoremBase` class:

## SEARCHING WITH SEARCHMANAGER

---

```
package com.commonware.android.search;

import android.app.ListActivity;
import android.app.SearchManager;
import android.content.Intent;
import android.os.Bundle;
import android.view.Menu;
import android.view.MenuItem;
import android.view.View;
import android.widget.ListAdapter;
import android.widget.ListView;
import android.widget.TextView;
import android.widget.Toast;
import java.util.ArrayList;
import org.xmlpull.v1.XmlPullParser;

abstract public class LoremBase extends ListActivity {
    abstract ListAdapter makeMeAnAdapter(Intent intent);

    private static final int LOCAL_SEARCH_ID = Menu.FIRST+1;
    private static final int GLOBAL_SEARCH_ID = Menu.FIRST+2;
    TextView selection;
    ArrayList<String> items=new ArrayList<String>();

    @Override
    public void onCreate(Bundle icle) {
        super.onCreate(icle);
        setContentView(R.layout.main);
        selection=(TextView)findViewById(R.id.selection);

        try {
            XmlPullParser xpp=getResources().getXml(R.xml.words);

            while (xpp.getEventType()!=XmlPullParser.END_DOCUMENT) {
                if (xpp.getEventType()==XmlPullParser.START_TAG) {
                    if (xpp.getName().equals("word")) {
                        items.add(xpp.getAttributeValue(0));
                    }
                }

                xpp.next();
            }
        } catch (Throwable t) {
            Toast
                .makeText(this, "Request failed: "+t.toString(), 4000)
                .show();
        }

        setDefaultKeyMode(DEFAULT_KEYS_SEARCH_LOCAL);

        onNewIntent(getIntent());
    }
}
```

## SEARCHING WITH SEARCHMANAGER

---

```
@Override
public void onNewIntent(Intent intent) {
    ListAdapter adapter=makeMeAnAdapter(intent);

    if (adapter==null) {
        finish();
    }
    else {
        setListAdapter(adapter);
    }
}

public void onItemClick(ListView parent, View v, int position,
                        long id) {
    selection.setText(parent.getAdapter().getItem(position).toString());
}

@Override
public boolean onCreateOptionsMenu(Menu menu) {
    menu.add(Menu.NONE, LOCAL_SEARCH_ID, Menu.NONE, "Local Search")
        .setIcon(android.R.drawable.ic_search_category_default);
    menu.add(Menu.NONE, GLOBAL_SEARCH_ID, Menu.NONE, "Global Search")
        .setIcon(android.R.drawable.ic_menu_search)
        .setAlphabeticShortcut(SearchManager.MENU_KEY);

    return(super.onCreateOptionsMenu(menu));
}

@Override
public boolean onOptionsItemSelected(MenuItem item) {
    switch (item.getItemId()) {
        case LOCAL_SEARCH_ID:
            onSearchRequested();
            return(true);

        case GLOBAL_SEARCH_ID:
            startSearch(null, false, null, true);
            return(true);
    }

    return(super.onOptionsItemSelected(item));
}
}
```

This activity takes care of everything related to showing a list of words, even loading the words out of an XML resource. What it does not do is come up with the ListAdapter to put into the ListView – that is delegated to the subclasses.

The main activity — LoremDemo — just uses a ListAdapter for the whole word list:

```
package com.commonware.android.search;
```

## SEARCHING WITH SEARCHMANAGER

---

```
import android.content.Intent;
import android.widget.AdapterView;
import android.widget.ListAdapter;

public class LoremDemo extends LoremBase {
    @Override
    ListAdapter makeMeAnAdapter(Intent intent) {
        return(new ArrayAdapter<String>(this,
            android.R.layout.simple_list_item_1,
            items));
    }
}
```

The search activity, though, does things a bit differently.

First, it inspects the Intent supplied to the abstract `makeMeAnAdapter()` method. That Intent comes from either `onCreate()` or `onNewIntent()`. If the intent is an `ACTION_SEARCH`, then we know this is a search. We can get the search query and, in the case of this silly demo, spin through the loaded list of words and find only those containing the search string. That list then gets wrapped in a `ListAdapter` and returned for display:

```
@Override
ListAdapter makeMeAnAdapter(Intent intent) {
    ListAdapter adapter=null;

    if (intent.getAction().equals(Intent.ACTION_SEARCH)) {
        String query=intent.getStringExtra(SearchManager.QUERY);
        List<String> results=searchItems(query);

        adapter=new ArrayAdapter<String>(this,
            android.R.layout.simple_list_item_1,
            results);
        setTitle("LoremSearch for: "+query);
    }

    return(adapter);
}
```

The logic in the `searchItems()` method that actually finds the matches looks like:

```
List<String> results=new ArrayList<String>();

for (String item : items) {
    if (item.indexOf(query)>-1) {
        results.add(item);
    }
}

return(results);
```

We will see the rest of that method later in this chapter.

### Update the Manifest

While this implements search, it doesn't tie it into the Android search system. That requires a few changes to the auto-generated `AndroidManifest.xml` file:

```
<manifest xmlns:android="http://schemas.android.com/apk/res/android"
    package="com.commonware.android.search">

    <uses-sdk
        android:minSdkVersion="7"
        android:targetSdkVersion="11"/>

    <supports-screens
        android:largeScreens="false"
        android:normalScreens="true"
        android:smallScreens="false"/>

    <application
        android:icon="@drawable/ic_launcher"
        android:label="Lorem Ipsum">
        <activity
            android:name=".LoremDemo"
            android:label="LoremDemo">
            <intent-filter>
                <action android:name="android.intent.action.MAIN"/>

                <category android:name="android.intent.category.LAUNCHER"/>
            </intent-filter>

            <meta-data
                android:name="android.app.default_searchable"
                android:value=".LoremSearch"/>
        </activity>
        <activity
            android:name=".LoremSearch"
            android:label="LoremSearch"
            android:launchMode="singleTop">
            <intent-filter>
                <action android:name="android.intent.action.SEARCH"/>

                <category android:name="android.intent.category.DEFAULT"/>
            </intent-filter>

            <meta-data
                android:name="android.app.searchable"
                android:resource="@xml/searchable"/>
        </activity>
    </application>
</manifest>
```

## SEARCHING WITH SEARCHMANAGER

---

The changes that are needed are:

- The LoremDemo main activity gets a meta-data element, with an android:name of android.app.default\_searchable and a android:value of the search implementation class (.LoremSearch)
- The LoremSearch activity gets an intent filter for android.intent.action.SEARCH, so search intents will be picked up
- The LoremSearch activity is set to have android:launchMode = "singleTop", which means at most one instance of this activity will be open at any time, so we don't wind up with a whole bunch of little search activities cluttering up the activity stack
- Add android:label and android:icon attributes to the application element — these will influence how your application appears in the Quick Search Box among other places
- The LoremSearch activity gets a meta-data element, with an android:name of android.app.searchable and an android:value of an XML resource containing more information about the search facility offered by this activity (@xml/searchable)

```
<searchable xmlns:android="http://schemas.android.com/apk/res/android"
  android:label="@string/searchLabel"
  android:hint="@string/searchHint"

  android:searchSuggestAuthority="com.commonware.android.search.LoremSuggestionProvider"
  android:searchSuggestSelection=" ? "
  android:searchSettingsDescription="@string/global"
  android:includeInGlobalSearch="true"
/>
```

That XML resource provides many bits of information, of which only two are needed for simple search-enabled applications:

- What name should appear in the search domain button to the left of the search field, identifying to the user where she is searching (android:label)
- What hint text should appear in the search field, to give the user a clue as to what they should be typing in (android:hint)

The other attributes found in that file, and the other search-related bits found in the manifest, will be covered later in this chapter.

## Searching for Meaning In Randomness

Given all that, search is now available — Android knows your application is searchable, what search domain to use when searching from the main activity, and the activity knows how to do the search.

The options menu for this application has both local and global search options. In the case of local search, we just call `onSearchRequested()`; in the case of global search, we call `startSearch()` with `true` in the last parameter, indicating the scope is global.



*Figure 403: The Lorem sample application, showing the local search popup*

Typing in a letter or two, then clicking Search, will bring up the search activity and the subset of words containing what you typed, with your search query in the activity title bar:



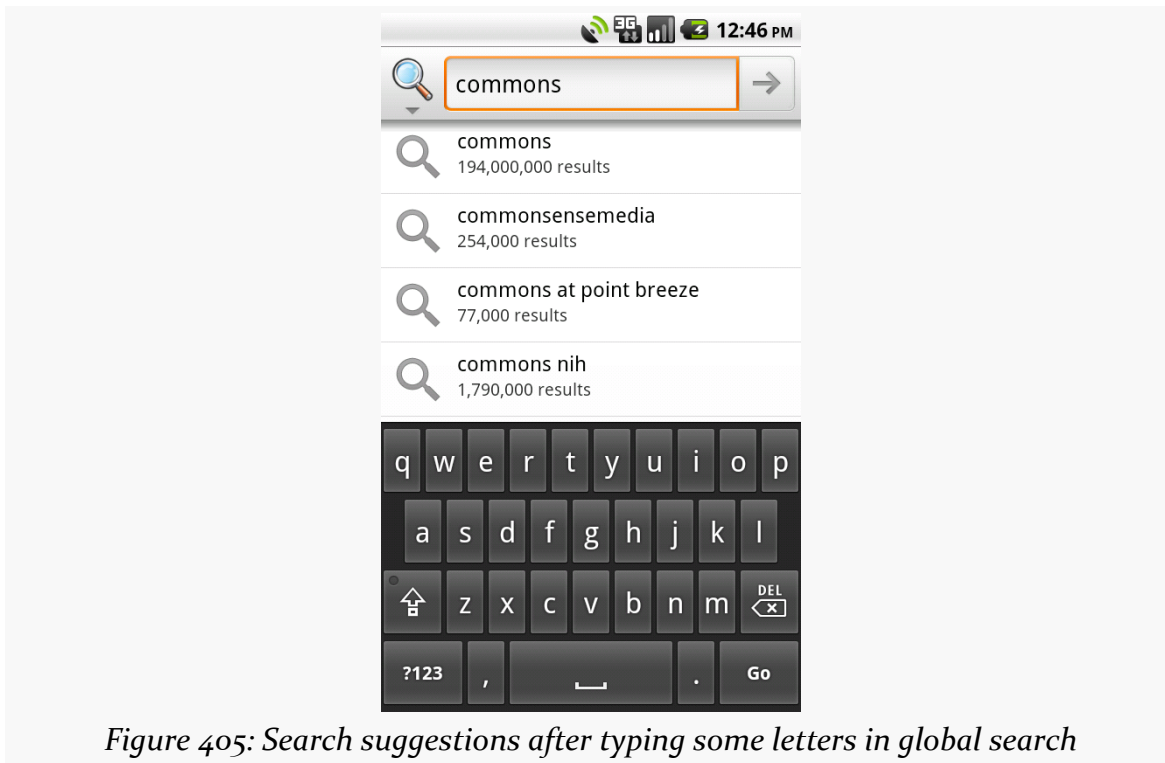
*Figure 404: The results of searching for 'co' in the Lorem search sample*

You can get the same effect if you just start typing in the main activity, since it is set up for triggering a local search.

### **May I Make a Suggestion?**

When you do a global search, you are given “suggestions” of search words or phrases that may be what you are searching for, to save you some typing on a small keyboard:





*Figure 405: Search suggestions after typing some letters in global search*

Your application, if it chooses, can offer similar suggestions. Not only will this give you the same sort of drop-down effect as you see with the global search above, but it also ties neatly into the Quick Search Box, as we will see later in this chapter.

To provide suggestions, you need to implement a `ContentProvider` and tie that provider into the search framework. You have two major choices for implementing a suggestion provider: use the built-in “recent” suggestion provider, or create your own from scratch.

### **SearchRecentSuggestionsProvider**

The “recent” suggestions provider gives you a quick and easy way to remember past searches and offer those as suggestions on future searches.

To use this facility, you must first create a custom subclass of `SearchRecentSuggestionsProvider`. Your subclass may be very simple, perhaps just a two-line constructor with no other methods. However, since Android does not automatically record recent queries for you, you will also need to give your search activity a way to record them such that the recent-suggestions provider can offer them as suggestions in the future.

## SEARCHING WITH SEARCHMANAGER

---

Below, we have a `LoremSuggestionProvider`, extending `SearchRecentSuggestionsProvider`, that also supplies a “bridge” for the search activity to record searches:

```
package com.commonware.android.search;

import android.content.Context;
import android.content.SearchRecentSuggestionsProvider;
import android.provider.SearchRecentSuggestions;

public class LoremSuggestionProvider
    extends SearchRecentSuggestionsProvider {
    private static String
AUTH="com.commonware.android.search>LoremSuggestionProvider";

    static SearchRecentSuggestions getBridge(Context ctxt) {
        return(new SearchRecentSuggestions(ctxt, AUTH,
                                           DATABASE_MODE_QUERIES));
    }

    public LoremSuggestionProvider() {
        super();

        setupSuggestions(AUTH, DATABASE_MODE_QUERIES);
    }
}
```

The constructor, besides the obligatory chain to the superclass, simply calls `setupSuggestions()`. This takes two parameters:

1. The authority under which you will register this provider in the manifest (see below)
2. A flag indicating where the suggestions will come from — in this case, we supply the required `DATABASE_MODE_QUERIES` flag

Of course, since this is a `ContentProvider`, you will need to add it to your manifest:

```
<provider
    android:name=".LoremSuggestionProvider"
    android:authorities="com.commonware.android.search>LoremSuggestionProvider"/>
```

The other thing that `LoremSuggestionProvider` has is a static method that creates a properly-configured instance of a `SearchRecentSuggestions` object. This object knows how to save search queries to the database that the content provider uses, so they will be served up as future suggestions. It needs to know the same authority and flag that you provide to `setupSuggestions()`.

That `SearchRecentSuggestions` is then used by our `LoremSearch` class, inside its `searchItems()` method that actually examines the list of nonsense words for matches:

```
private List<String> searchItems(String query) {
    LoremSuggestionProvider
        .getBridge(this)
        .saveRecentQuery(query, null);

    List<String> results=new ArrayList<String>();

    for (String item : items) {
        if (item.indexOf(query)>-1) {
            results.add(item);
        }
    }

    return(results);
}
```

In this case, we always record the search, though you can imagine that some applications might not save searches that are invalid for one reason or another.

### Custom Suggestion Providers

If you want to provide search suggestions based on something else – actual data, searches conducted by others that you aggregate via a Web service, etc. — you will need to implement your own `ContentProvider` that supplies that information. As with `SearchRecentSuggestionsProvider`, you will need to add your `ContentProvider` to the manifest so that Android knows it exists.

The details for doing this will be covered in a future edition of this book. For now, you are best served with the Android SearchManager [documentation on the topic](#).

### Integrating Suggestion Providers

Before your suggestions will appear, though, you need to tell Android to use your `ContentProvider` as the source of suggestions. There are two attributes on your searchable XML that make this connection:

1. `android:searchSuggestAuthority` indicates the content authority for your suggestions — this is the same authority you used for your `ContentProvider`

## SEARCHING WITH SEARCHMANAGER

---

2. `android:searchSuggestSelection` is how the suggestion should be packaged as a query in the `ACTION_SEARCH` Intent — unless you have some reason to do otherwise, " ? " is probably a fine value to use

The result is that when we do our local search, we get the drop-down of past searches as suggestions:



*Figure 406: The Android local search popup, showing the IME and a previous search*

There is also a `clearHistory()` method on `SearchRecentSuggestions` that you can use, perhaps from a menu choice, to clear out the search history, in case it is cluttered beyond usefulness.

## Putting Yourself (Almost) On Par with Google

The Quick Search Box is Android's new term for the search widget at the top of the home screen. This is the same UI that appears when your application starts a global search. When you start typing, it shows possible matches culled from both the device and the Internet. If you choose one of the suggestions, it takes you to that item – choose a contact, and you visit the contact in the Contacts application. If you choose a Web search term, or you just submit whatever you typed in, Android will

fire up a Browser instance showing you search results from Google. The order of suggestions is adaptive, as Android will attempt to show the user the sorts of things the user typically searches for (e.g., if the user clicks on contacts a lot in prior searches, it may prioritize suggested contacts in the suggestion list).

Your application can be tied into the Quick Search Box. However, it is important to understand that being in the Quick Search Box does *not* mean that your content will be searched. Instead, your *suggestions provider* will be queried based on what the user has typed in, and those suggestions will be blended into the overall results.

And, your application will not show up in Quick Search Box suggestions automatically — the user has to “opt in” to have your results included.

And, until the user demonstrates an interest in your results, your application’s suggestions will be buried at the bottom of the list.

This means that integrating with the Quick Search Box, while still perhaps valuable, is not exactly what some developers will necessarily have in mind. That being said, here is how to achieve this integration.

*NOTE:* there is some flaw in the Android 2.2 emulator that prevents this from working, though it works fine on Android 2.2 hardware.

### Implement a Suggestions Provider

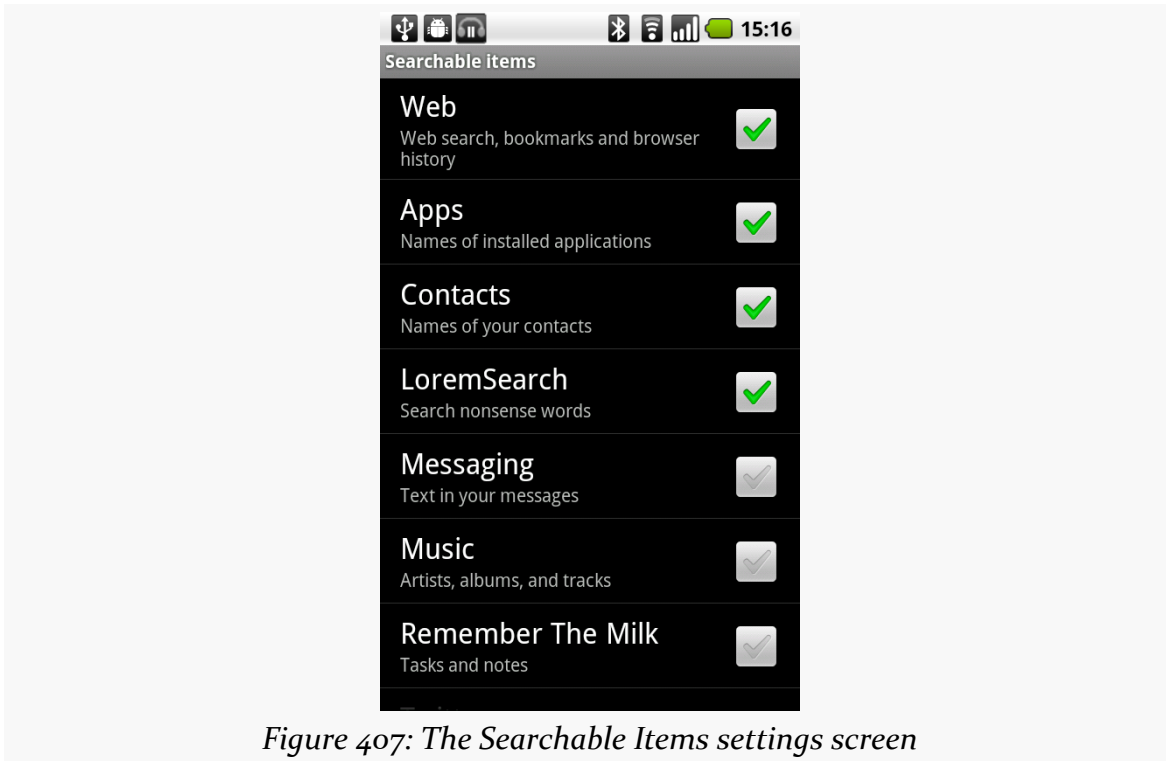
Your first step is to implement a suggestions provider, as described in the [previous section](#). Again, Android does not search your application, but rather queries your suggestions provider. If you do not have a suggestions provider, you will not be part of the Quick Search Box. As we will see below, this approach means you will need to think about what sort of suggestion provider to create.

### Augment the Metadata

Next, you need to tell Android to tie your application into the Quick Search Box suggestion list. To do that, you need to add the `android:includeInGlobalSearch` attribute to your searchable XML, setting it to true. You probably also should consider adding the `android:searchSettingsDescription`, as this will be shown in the UI for the user to configure what suggestions the Quick Search Box shows.

### Convince the User

Next, the user needs to activate your application to be included in the Quick Search Box suggestion roster. To do that, the user needs to go into Settings, find where the “Searchable Items” screen is, and check the checkbox associated with your application:



*Figure 407: The Searchable Items settings screen*

The precise location of the “Searchable Items” screen varies by OS version and possibly by device.

Your application’s label and the value of `android:searchSettingsDescription` are what appears to the left of the checkbox.

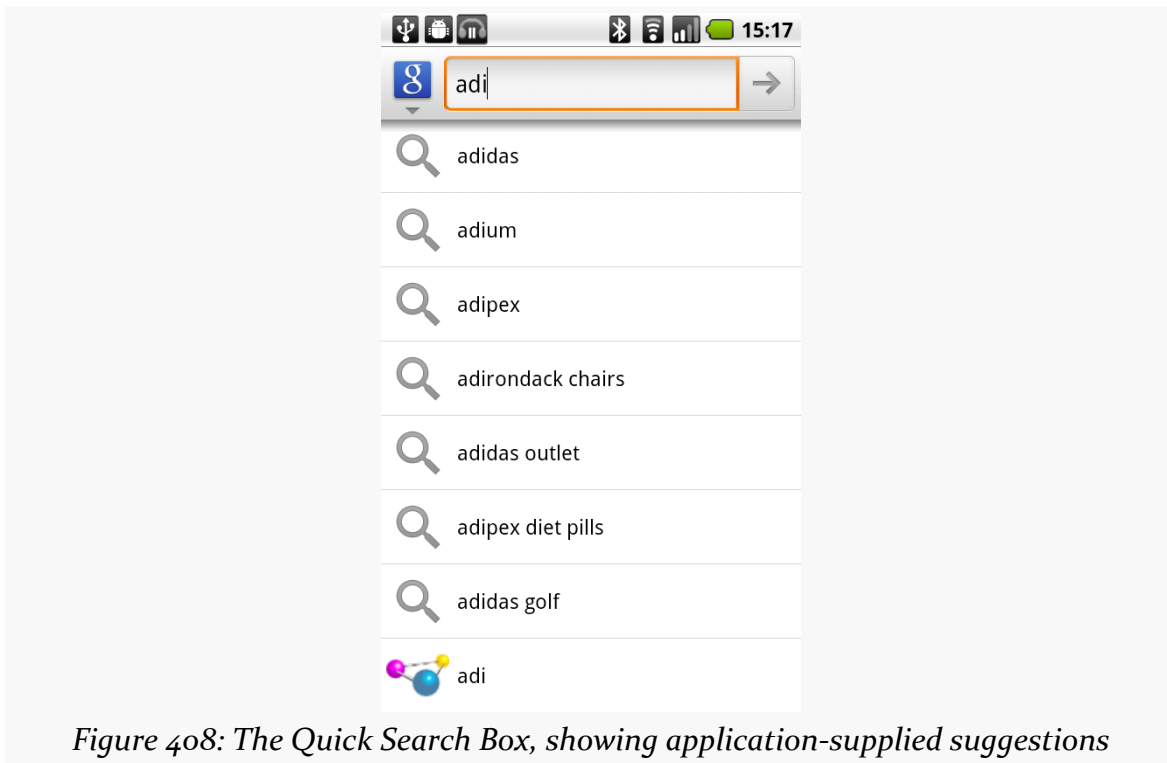
You have no way of toggling this on yourself — the user has to do it. You may wish to mention this in the documentation for your application.

### The Results

If you and the user do all of the above, now when the user initiates a search, your suggestions will be poured into the suggestions list, at the bottom:

## SEARCHING WITH SEARCHMANAGER

---

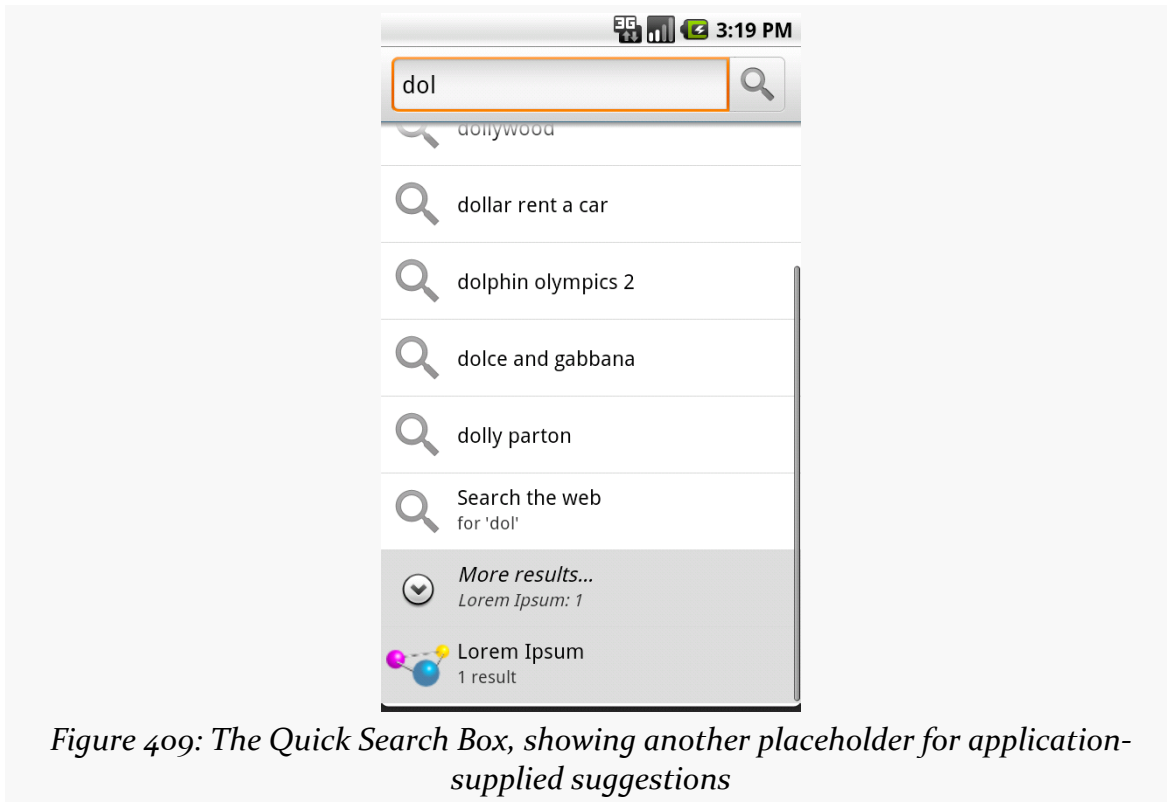


*Figure 408: The Quick Search Box, showing application-supplied suggestions*

On versions of Android prior to 2.2, to actually see your suggestions, the user also needs to click the arrow to “fold open” the actual suggestions:

## SEARCHING WITH SEARCHMANAGER

---



*Figure 409: The Quick Search Box, showing another placeholder for application-supplied suggestions*

Even here, we do not see the actual suggestion. However, if the user clicks on that item, your suggestions then take over the list:





*Figure 410: The Quick Search Box, showing application-supplied suggestions*

Again, Android is not showing *actual data* from your application – our list of nonsense words does not contain the value “dol”. Instead, Android is showing *suggestions* from your suggestion provider based on what the user typed in. In this case, our application’s suggestion provider is based on the built-in `SearchRecentSuggestionsProvider` class, meaning the suggestions are *past queries*, not actual results.

Hence, what you want to have appear in the Quick Search Box suggestion list will heavily influence what sort of suggestion provider you wish to create. While a `SearchRecentSuggestionsProvider` is simple, what you get in the Quick Search Box suggestions may not be that useful to users. Instead, you may wish to create your own custom suggestions provider, providing suggestions from actual data or other more useful sources, perhaps in addition to saved searches.

# Handling System Events

---

If you have ever looked at the list of available Intent actions in the SDK documentation for the Intent class, you will see that there are lots of possible actions.

There are even actions that are not listed in that spot in the documentation, but are scattered throughout the rest of the SDK documentation.

The vast majority of these you will never raise yourself. Instead, they are broadcast by Android, to signify certain system events that have occurred and that you might want to take note of, if they affect the operation of your application.

This chapter examines a couple of these, to give you the sense of what is possible and how to make use of these sorts of events. Note that we examined another similar one of these, to get control at boot time, back in [the chapter on AlarmManager](#).

## Prerequisites

Understanding this chapter requires that you have read the core chapters, particularly [the one on BroadcastReceiver](#). Also, it might be a good idea to read [the section on the BOOT\\_COMPLETED system broadcast](#) in [the chapter on AlarmManager](#).

## I Sense a Connection Between Us...

Generally speaking, Android applications do not care what sort of Internet connection is being used — 3G, GPRS, WiFi, [lots of trained carrier pigeons](#), or whatever. So long as there is an Internet connection, the application is happy.

## HANDLING SYSTEM EVENTS

---

Sometimes, though, you may specifically want WiFi. This would be true if your application is bandwidth-intensive and you want to ensure that, should WiFi stop being available, you cut back on your work so as not to consume too much 3G/GPRS bandwidth, which is usually subject to some sort of cap or metering.

There is an `android.net.wifi.WIFI_STATE_CHANGED` Intent that will be broadcast, as the name suggests, whenever the state of the WiFi connection changes. You can arrange to receive this broadcast and take appropriate steps within your application.

This Intent requires no special permission. Hence, all you need to do is register a BroadcastReceiver for `android.net.wifi.WIFI_STATE_CHANGED`, either via `registerReceiver()`, or via the `<receiver>` element in `AndroidManifest.xml`, such as the one shown below, from the [SystemEvents/OnWiFiChange](#) sample project:

```
<?xml version="1.0" encoding="utf-8"?>
<manifest android:versionCode="1"
    android:versionName="1.0"
    package="com.commonsware.android.sysevents.wifi"
    xmlns:android="http://schemas.android.com/apk/res/android">

    <application android:icon="@drawable/cw"
        android:label="@string/app_name">
        <receiver android:name=".OnWiFiChangeReceiver">
            <intent-filter>
                <action android:name="android.net.wifi.WIFI_STATE_CHANGED" />
            </intent-filter>
        </receiver>
    </application>
</manifest>
```

All we do in the manifest is tell Android to create an `OnWiFiChangeReceiver` object when a `android.net.wifi.WIFI_STATE_CHANGED` Intent is broadcast, so the receiver can do something useful.

In the case of `OnWiFiChangeReceiver`, it examines the value of the `EXTRA_WIFI_STATE` “extra” in the supplied Intent and logs an appropriate message:

```
package com.commonsware.android.sysevents.wifi;

import android.content.BroadcastReceiver;
import android.content.Context;
import android.content.Intent;
import android.net.wifi.WifiManager;
import android.util.Log;

public class OnWiFiChangeReceiver extends BroadcastReceiver {
    @Override
```

## HANDLING SYSTEM EVENTS

---

```
public void onReceive(Context context, Intent intent) {
    int state=intent.getIntExtra(WifiManager.EXTRA_WIFI_STATE, -1);
    String msg=null;

    switch (state) {
        case WifiManager.WIFI_STATE_DISABLED:
            msg="is disabled";
            break;

        case WifiManager.WIFI_STATE_DISABLING:
            msg="is disabling";
            break;

        case WifiManager.WIFI_STATE_ENABLED:
            msg="is enabled";
            break;

        case WifiManager.WIFI_STATE_ENABLING:
            msg="is enabling";
            break;

        case WifiManager.WIFI_STATE_UNKNOWN :
            msg="has an error";
            break;

        default:
            msg="is acting strangely";
            break;
    }

    if (msg!=null) {
        Log.d("OnWiFiChanged", "WiFi "+msg);
    }
}
}
```

The EXTRA\_WIFI\_STATE “extra” tells you what the state has become (e.g., we are now disabling or are now disabled), so you can take appropriate steps in your application.

Note that, to test this, you will need an actual Android device, as the emulator does not specifically support simulating WiFi connections.

## Feeling Drained

One theme with system events is to use them to help make your users happier by reducing your impacts on the device while the device is not in a great state. In the preceding section, we saw how you could find out when WiFi was disabled, so you might not use as much bandwidth when on 3G/GPRS. However, not every application uses so much bandwidth as to make this optimization worthwhile.

## HANDLING SYSTEM EVENTS

---

However, most applications are impacted by battery life. Dead batteries run no apps.

So whether you are implementing a battery monitor or simply want to discontinue background operations when the battery gets low, you may wish to find out how the battery is doing.

There is an `ACTION_BATTERY_CHANGED` Intent that gets broadcast as the battery status changes, both in terms of charge (e.g., 80% charged) and charging (e.g., the device is now plugged into AC power). You simply need to register to receive this Intent when it is broadcast, then take appropriate steps.

One of the limitations of `ACTION_BATTERY_CHANGED` is that you have to use `registerReceiver()` to set up a `BroadcastReceiver` to get this Intent when broadcast. You cannot use a manifest-declared receiver as shown in the preceding two sections.

In the [SystemEvents/OnBattery](#) sample project, you will find a layout containing a `ProgressBar`, a `TextView`, and an `ImageView`, to serve as a battery monitor:

```
<?xml version="1.0" encoding="utf-8"?>
<LinearLayout xmlns:android="http://schemas.android.com/apk/res/android"
    android:orientation="vertical"
    android:layout_width="match_parent"
    android:layout_height="match_parent"
    >
    <ProgressBar android:id="@+id/bar"
        style="?android:attr/progressBarStyleHorizontal"
        android:layout_width="match_parent"
        android:layout_height="wrap_content" />
    <LinearLayout
        android:orientation="horizontal"
        android:layout_width="match_parent"
        android:layout_height="wrap_content"
        >
        <TextView android:id="@+id/level"
            android:layout_width="0px"
            android:layout_height="wrap_content"
            android:layout_weight="1"
            android:textSize="16pt"
            />
        <ImageView android:id="@+id/status"
            android:layout_width="0px"
            android:layout_height="wrap_content"
            android:layout_weight="1"
            />
    </LinearLayout>
</LinearLayout>
```

## HANDLING SYSTEM EVENTS

---

This layout is used by a BatteryMonitor activity, which registers to receive the ACTION\_BATTERY\_CHANGED Intent in onResume() and unregisters in onPause():

```
package com.commonware.android.sysevents.battery;

import android.app.Activity;
import android.content.BroadcastReceiver;
import android.content.Context;
import android.content.Intent;
import android.content.IntentFilter;
import android.os.Bundle;
import android.os.BatteryManager;
import android.widget.ProgressBar;
import android.widget.ImageView;
import android.widget.TextView;

public class BatteryMonitor extends Activity {
    private ProgressBar bar=null;
    private ImageView status=null;
    private TextView level=null;

    @Override
    public void onCreate(Bundle savedInstanceState) {
        super.onCreate(savedInstanceState);
        setContentView(R.layout.main);

        bar=(ProgressBar)findViewById(R.id.bar);
        status=(ImageView)findViewById(R.id.status);
        level=(TextView)findViewById(R.id.level);
    }

    @Override
    public void onResume() {
        super.onResume();

        registerReceiver(onBatteryChanged,
            new IntentFilter(Intent.ACTION_BATTERY_CHANGED));
    }

    @Override
    public void onPause() {
        super.onPause();

        unregisterReceiver(onBatteryChanged);
    }

    BroadcastReceiver onBatteryChanged=new BroadcastReceiver() {
        public void onReceive(Context context, Intent intent) {
            int pct=100*intent.getIntExtra("level", 1)/intent.getIntExtra("scale", 1);

            bar.setProgress(pct);
            level.setText(String.valueOf(pct));
        }
    }
}
```

## HANDLING SYSTEM EVENTS

---

```
switch(intent.getIntExtra("status", -1)) {
    case BatteryManager.BATTERY_STATUS_CHARGING:
        status.setImageResource(R.drawable.charging);
        break;

    case BatteryManager.BATTERY_STATUS_FULL:
        int plugged=intent.getIntExtra("plugged", -1);

        if (plugged==BatteryManager.BATTERY_PLUGGED_AC ||
            plugged==BatteryManager.BATTERY_PLUGGED_USB) {
            status.setImageResource(R.drawable.full);
        }
        else {
            status.setImageResource(R.drawable.unplugged);
        }
        break;

    default:
        status.setImageResource(R.drawable.unplugged);
        break;
}
};
```

The key to ACTION\_BATTERY\_CHANGED is in the “extras”. Many “extras” are packaged in the Intent, to describe the current state of the battery, such as the following constants defined on the BatteryManager class:

1. EXTRA\_HEALTH, which should generally be BATTERY\_HEALTH\_GOOD
2. EXTRA\_LEVEL, which is the proportion of battery life remaining as an integer, specified on the scale described by the scale “extra”
3. EXTRA\_PLUGGED, which will indicate if the device is plugged into AC power (BATTERY\_PLUGGED\_AC) or USB power (BATTERY\_PLUGGED\_USB)
4. EXTRA\_SCALE, which indicates the maximum possible value of level (e.g., 100, indicating that level is a percentage of charge remaining)
5. EXTRA\_STATUS, which will tell you if the battery is charging (BATTERY\_STATUS\_CHARGING), full (BATTERY\_STATUS\_FULL), or discharging (BATTERY\_STATUS\_DISCHARGING)
6. EXTRA\_TECHNOLOGY, which indicates what sort of battery is installed (e.g., "Li-Ion")
7. EXTRA\_TEMPERATURE, which tells you how warm the battery is, in tenths of a degree Celsius (e.g., 213 is 21.3 degrees Celsius)
8. EXTRA\_VOLTAGE, indicating the current voltage being delivered by the battery, in millivolts

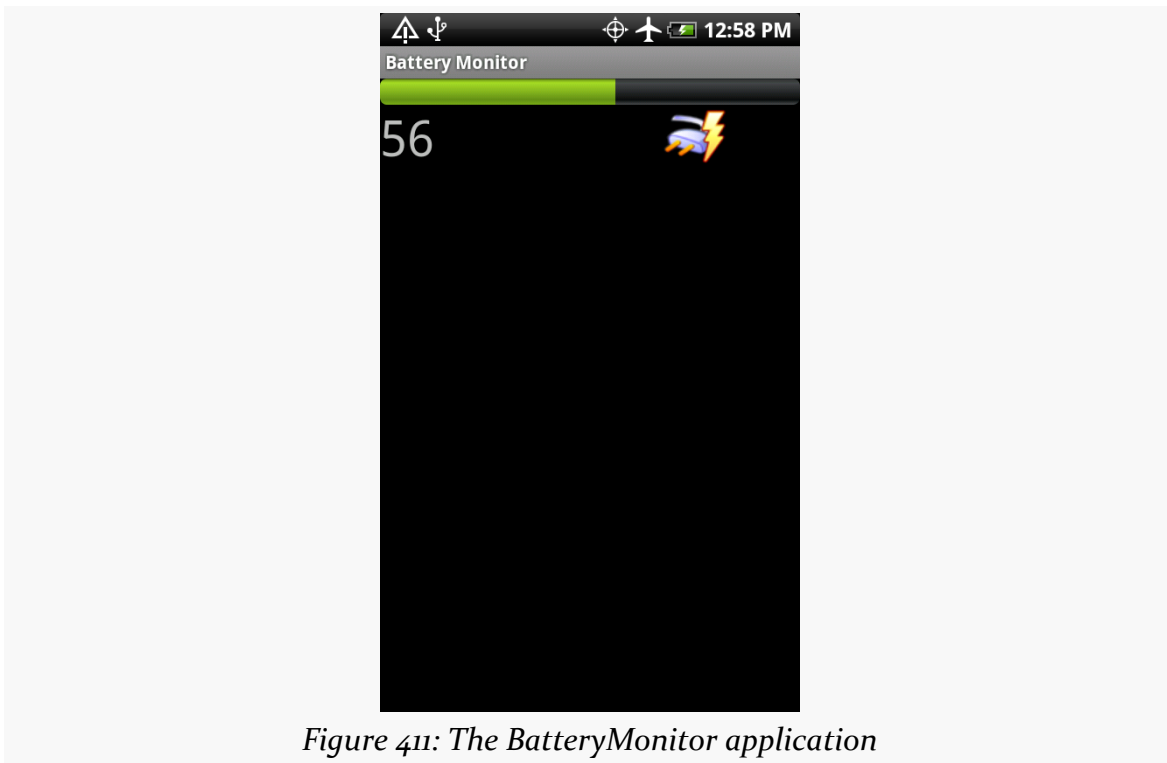
## HANDLING SYSTEM EVENTS

---

In the case of BatteryMonitor, when we receive an ACTION\_BATTERY\_CHANGED Intent, we do three things:

- We compute the percentage of battery life remaining, by dividing the level by the scale
- We update the ProgressBar and TextView to display the battery life as a percentage
- We display an icon, with the icon selection depending on whether we are charging (status is BATTERY\_STATUS\_CHARGING), full but on the charger (status is BATTERY\_STATUS\_FULL and plugged is BATTERY\_PLUGGED\_AC or BATTERY\_PLUGGED\_USB), or are not plugged in

If you plug this into a device, it will show you the device's charge level:



*Figure 411: The BatteryMonitor application*

### Sticky Intents and the Battery

Android has a notion of “sticky broadcast Intents”. Normally, a broadcast Intent will be delivered to interested parties and then discarded. A sticky broadcast Intent is delivered to interested parties and retained until the next matching Intent is broadcast. Applications can call `registerReceiver()` with an `IntentFilter` that



matches the sticky broadcast, but with a null `BroadcastReceiver`, and get the sticky Intent back as a result of the `registerReceiver()` call.

This may sound confusing. Let's look at this in the context of the battery.

Earlier in this section, you saw how to register for `ACTION_BATTERY_CHANGED` to get information about the battery delivered to you. You can also, though, get the latest battery information without registering a receiver. Just create an `IntentFilter` to match `ACTION_BATTERY_CHANGED` (as shown above) and call `registerReceiver()` with that filter and a null `BroadcastReceiver`. The Intent you get back from `registerReceiver()` is the last `ACTION_BATTERY_CHANGED` Intent that was broadcast, with the same extras. Hence, you can use this to get the current (or near-current) battery status, rather than having to bother registering an actual `BroadcastReceiver`.

### Battery and the Emulator

Your emulator does not really have a battery. If you run this sample application on an emulator, you will see, by default, that your device has 50% fake charge remaining and that it is being charged. However, it is charged infinitely slowly, as it will not climb past 50%... at least, not without help.

While the emulator will only show fixed battery characteristics, you can change what those values are, through the highly advanced user interface known as `telnet`.

You may have noticed that your emulator title bar consists of the name of your AVD plus a number, frequently 5554. That number is not merely some engineer's favorite number. It is also an open port, on your emulator, to which you can `telnet` into, on `localhost` (127.0.0.1) on your development machine.

There are many commands you can issue to the emulator by means of `telnet`. To change the battery level, use `power capacity NN`, where NN is the percentage of battery life remaining that you wish the emulator to return. If you do that while you have an `ACTION_BATTERY_CHANGED` `BroadcastReceiver` registered, the receiver will receive a broadcast Intent, informing you of the change.

You can also experiment with some of the other power subcommands (e.g., `power ac on` or `power ac off`), or other commands (e.g., `geo`, to send simulated GPS fixes, just as you can do from DDMS).

### Other Power Triggers

If you are only interested in knowing when the device has been attached to, or detached from, a source of external power, there are different broadcast Intent actions you can monitor: `ACTION_POWER_CONNECTED` and `ACTION_POWER_DISCONNECTED`. These are only broadcast when the power source changes, not just every time the battery changes charge level. Hence, these will be more efficient, as your code will be invoked less frequently. Better still, you can use manifest-registered broadcast receivers for these, bypassing the limits the system puts on `ACTION_BATTERY_CHANGED`.



# Remote Services and the Binding Pattern

---

Earlier in this book, we covered using services by sending commands to them to be processed. That “command pattern” is one of two primary means of interacting with a service — the binding pattern is the other. With the binding pattern, your service exposes a more traditional API, in the form of a “binder” object with methods of your choosing. On the plus side, you get a richer interface. However, it more tightly ties your activity to your service, which may cause you problems with configuration changes.

Either the command pattern or the binding pattern can be used, if desired, across process boundaries, with the client being some third-party application. In either case, you will need to export your service via an `<intent-filter>`. And, in the case of the binding pattern, your “binder” implementation will have some restrictions.

This chapter covers the binding pattern for local services, plus inter-process commands and binding (a.k.a., remote services).

## Prerequisites

Understanding this chapter requires that you have read the chapters on:

- [broadcast Intents](#)
- [service theory](#)

## The Binding Pattern

Implementing the binding pattern requires work on both the service side and the client side. The service will need to have a full implementation of the `onBind()` method, which typically just returns `null` for a service solely implementing the command pattern. And, the client (e.g., an activity) will need to ask to bind to the service, instead of (or perhaps in addition to) starting the service.

### What the Service Does

The service implements a subclass of `Binder` that represents the service's exposed API. For a local service, your `Binder` can have pretty much whatever methods you want: method names, parameters, return types, and exceptions thrown are up to you. When you get into remote services, your `Binder` implementation will be substantially more constrained, to support inter-process communication.

Then, your `onBind()` method returns an instance of the `Binder`.

### What the Client Does

Clients call `bindService()`, supplying the `Intent` that identifies the service, a `ServiceConnection` object representing the client side of the binding, and an optional `BIND_AUTO_CREATE` flag. As with `startService()`, `bindService()` is asynchronous. The client will not know anything about the status of the binding until the `ServiceConnection` object is called with `onServiceConnected()`. This not only indicates the binding has been established, but for local services it provides the `Binder` object that the service returned via `onBind()`. At this point, the client can use the `Binder` to ask the service to do work on its behalf.

Note that if the service is not already running, and if you provide `BIND_AUTO_CREATE`, then the service will be created first before being bound to the client. If you skip `BIND_AUTO_CREATE`, and the service is not already running, `bindService()` is supposed to return `false`, indicating there was no existing service to bind to. However, in actuality, Android returns `true`, due to [an apparent bug](#).

Eventually, the client will need to call `unbindService()`, to indicate it no longer needs to communicate with the service. For example, an activity might call `bindService()` in its `onCreate()` method, then call `unbindService()` in its `onDestroy()` method. Once you call `unbindService()`, your `Binder` object is no longer safe to be used by the client. If there are no other bound clients to the

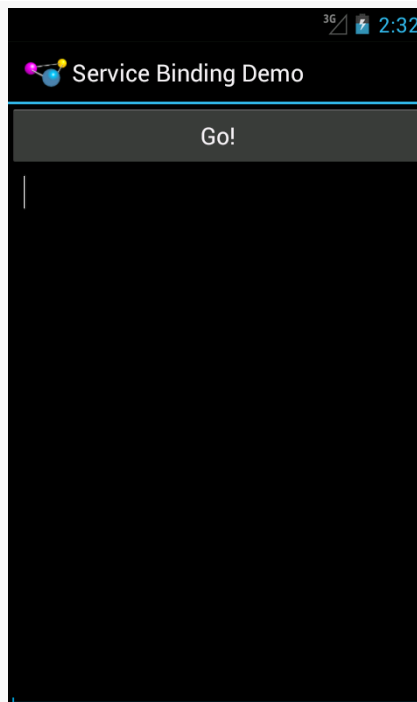
service, Android will shut down the service as well, releasing its memory. Hence, we do not need to call `stopService()` ourselves – Android handles that, if needed, as a side effect of unbinding.

Your `ServiceConnection` object will also need an `onServiceDisconnected()` method. This will be called only if there is an unexpected disconnection, such as the service crashing with an unhandled exception.

### A Binding Sample

Our sample revolves around a scripting language called [BeanShell](#). BeanShell is, in effect, a Java interpreter for Java. We will go into greater detail about BeanShell [elsewhere in this book](#). For here, most of what you need to know is that you can have BeanShell interpret a chunk of source code by creating an `Interpreter` object and calling `eval()`.

In the [AdvServices/Binding](#) sample project, we have an activity, displaying a fragment, containing the world's smallest IDE:



*Figure 412: Binding Demo, As Initially Launched*

## REMOTE SERVICES AND THE BINDING PATTERN

---

When the user types in some Java code and clicks the button, we want to execute that code. And, in this case, we will use a service and the binding pattern to do so.

We start by defining an interface that will serve as the “contract” between the client (fragment) and service. This interface, `IScript`, contains a single `executeScript()` method:

```
package com.commonware.android.advservice.binding;

// Declare the interface.
interface IScript {
    void executeScript(String script);
}
```

Our service, `BshService`, implements just one method, `onBind()`, which returns an instance of a `BshBinder`:

```
package com.commonware.android.advservice.binding;

import android.app.Service;
import android.content.Context;
import android.content.Intent;
import android.os.Binder;
import android.os.IBinder;
import android.util.Log;
import bsh.EvalError;
import bsh.Interpreter;

public class BshService extends Service {
    @Override
    public IBinder onBind(Intent intent) {
        return(new BshBinder(this));
    }

    private static class BshBinder extends Binder implements IScript {
        private Interpreter i=new Interpreter();

        BshBinder(Context ctxt) {
            try {
                i.set("context", ctxt);
            }
            catch (EvalError e) {
                Log.e("BshService", "Error executing script", e);
            }
        }

        public void executeScript(String script) {
            try {
                i.eval(script);
            }
            catch (bsh.EvalError e) {
```

## REMOTE SERVICES AND THE BINDING PATTERN

---

```
        Log.e("BshService", "Error executing script", e);
    }
}
};
}
```

BshBinder implements the IScript interface and is where our BeanShell “business logic” resides:

- In the BshBinder initializers, we create an instance of the BeanShell Interpreter class
- In the BshBinder constructor, we inject an object — the BshService instance — into the BeanShell interpreted environment as what amounts to a global object, named context
- In the executeScript() method, we just pass the supplied BeanShell source to the eval() method of our Interpreter

Our fragment, BshFragment, loads our layout, res/layout/main.xml, containing a Button and a multi-line EditText:

```
<?xml version="1.0" encoding="utf-8"?>
<LinearLayout xmlns:android="http://schemas.android.com/apk/res/android"
    android:layout_width="match_parent"
    android:layout_height="match_parent"
    android:orientation="vertical">

    <Button
        android:id="@+id/eval"
        android:layout_width="match_parent"
        android:layout_height="wrap_content"
        android:text="@string/go"/>

    <EditText
        android:id="@+id/script"
        android:layout_width="match_parent"
        android:layout_height="match_parent"
        android:gravity="top"
        android:inputType="textMultiLine"/>

</LinearLayout>
```

The implementation of onCreateView() simply loads that layout, gets the Button, sets up the fragment as being the click listener for the Button, and disables the Button:

```
public View onCreateView(LayoutInflater inflater,
    ViewGroup container,
    Bundle savedInstanceState) {
```



## REMOTE SERVICES AND THE BINDING PATTERN

---

```
View result=inflater.inflate(R.layout.main, container, false);

btn=(Button)result.findViewById(R.id.eval);
btn.setOnClickListener(this);
btn.setEnabled(false);

setRetainInstance(true);

return(result);
}
```

The reason why we disable the Button is because we are not connected to our service at this point, and until we are, we cannot allow the user to try to execute a BeanShell script.

In `onActivityCreated()` of our fragment, we bind to the service:

```
@Override
public void onActivityCreated(Bundle savedInstanceState) {
    super.onActivityCreated(savedInstanceState);

    getActivity().getApplicationContext()
        .bindService(new Intent(getActivity(),
            BshService.class), this,
            Context.BIND_AUTO_CREATE);
}
```

You will notice something curious here: `getApplicationContext()`. Technically, we could bind to the service directly from the Activity, by calling `bindService()` on it, as `bindService()` is a method on `Context`. However, our service binding represents some state, and it is possible that this state will hold a reference to the `Context` that created the binding. In that case, we run the risk of leaking our original activity during a configuration change. The `getApplicationContext()` method returns the global `Application` singleton, which is a `Context` suitable for binding, but one that cannot be leaked, since it is already in a global scope.

Some time after `onActivityCreated()` is called and we call `bindService()`, our `onServiceConnected()` method will be called, as we designated our fragment to be the `ServiceConnection`. Here, we can cast the `IBinder` object we receive to be our `IScript` interface to the service, and we can enable the Button:

```
@Override
public void onServiceConnected(ComponentName className, IBinder binder) {
    service=(IScript)binder;
    btn.setEnabled(true);
}
```

## REMOTE SERVICES AND THE BINDING PATTERN

---

Since we are implementing the `ServiceConnection` interface, our fragment also needs to implement the `onServiceDisconnected()` method, invoked if our service crashes. Here, we delegate responsibility to a `disconnect()` private method, which removes our link to the `IScript` object and disables our `Button`:

```
@Override
public void onServiceDisconnected(ComponentName className) {
    disconnect();
}

private void disconnect() {
    service=null;
    btn.setEnabled(false);
}
```

And, when our fragment is destroyed, we unbind from the service (using the same `Context` as before, from `getApplicationContext()`) and `disconnect()`:

```
@Override
public void onDestroy() {
    getActivity().getApplicationContext().unbindService(this);
    disconnect();

    super.onDestroy();
}
```

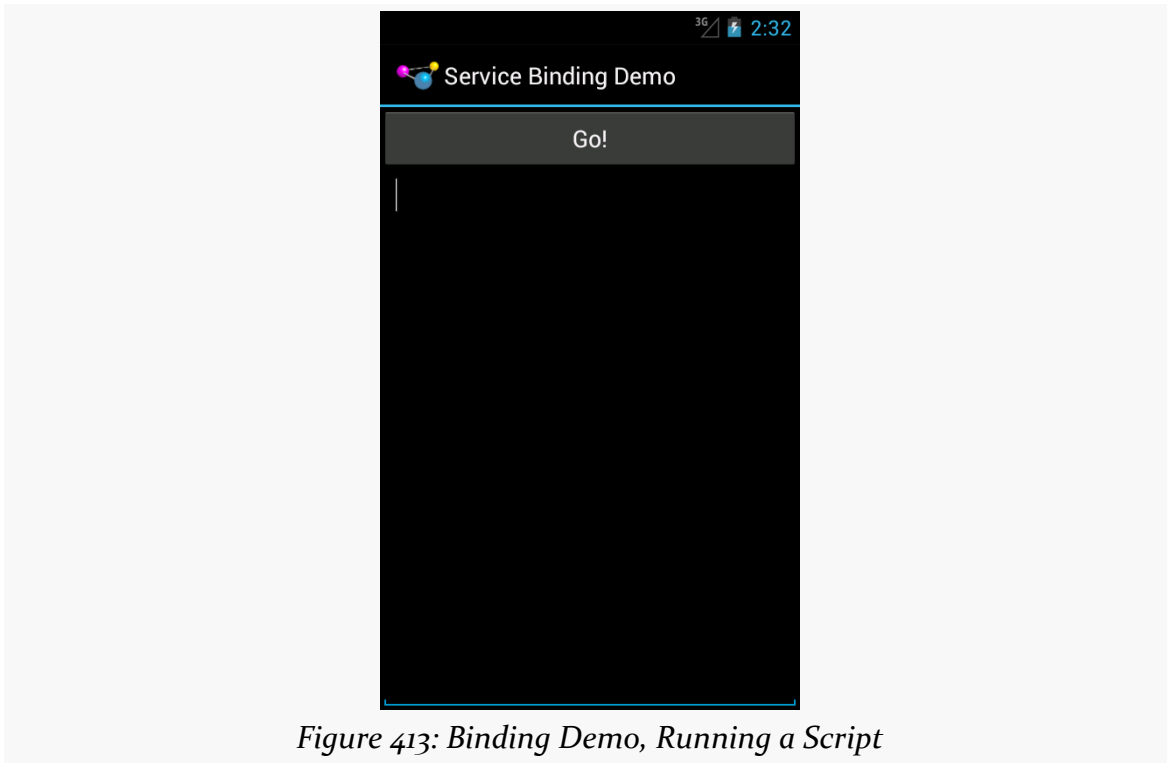
However, in between `onServiceConnected()` and either `onServiceDisconnected()` or `onDestroy()`, the user can type in and submit a script, triggering a call to `onClick()` when the user clicks the “Go!” button:

```
@Override
public void onClick(View view) {
    EditText script=(EditText)getView().findViewById(R.id.script);
    String src=script.getText().toString();

    service.executeScript(src);
}
```

Here, we get the source code from the `EditText` and pass it to the `IScript` interface for processing. In this case, we happen to do so on the main application thread, which means that the script will be evaluated on the main application thread as well.

The result is that the user can enter in a script — including referencing our context global `Context` object — and execute it by clicking “Go!”:



### Starting and Binding

Some developers will use *both* `startService()` and `bindService()` at the same time. The typical argument is that they need frequent updates from the service (e.g., percentage of progress, for updating a `ProgressBar`) in the client and are concerned about the overhead of sending broadcasts.

With the advent of `LocalBroadcastManager` — giving you the benefits of the broadcast `Intent` semantics without the IPC overhead — binding to a service you are using with `startService()` should no longer be necessary.

### When IPC Attacks!

If you wish to extend the binding pattern to serve in the role of IPC, whereby other processes can get at your `Binder` and call its methods, you will need to use AIDL: the Android Interface Description Language. If you have used IPC mechanisms like COM, CORBA, or the like, you will recognize the notion of IDL. AIDL describes the public IPC interface, and Android supplies tools to build the client and server side of that interface.

With that in mind, let's take a look at AIDL and IPC.

### Write the AIDL

IDLs are frequently written in a “language-neutral” syntax. AIDL, on the other hand, looks a lot like a Java interface. For example, here is some AIDL:

```
package com.commonware.android.advservice;

// Declare the interface.
interface IScript {
    void executeScript(String script);
}
```

As you will notice, this looks suspiciously like the regular Java interface we used in the simple binding example earlier in this chapter.

As with a Java interface, you declare a package at the top. As with a Java interface, the methods are wrapped in an interface declaration (`interface IScript { ... }`). And, as with a Java interface, you list the methods you are making available.

The differences, though, are critical.

First, not every Java type can be used as a parameter. Your choices are:

1. Primitive values (int, float, double, boolean, etc.)
2. String and CharSequence
3. List and Map (from `java.util`)
4. Any other AIDL-defined interfaces
5. Any Java classes that implement the Parcelable interface, which is Android's flavor of serialization

In the case of the latter two categories, you need to include import statements referencing the names of the classes or interfaces that you are using (e.g., `import com.commonware.android.ISomething`). This is true even if these classes are in your own package — you have to import them anyway.

Next, parameters can be classified as `in`, `out`, or `inout`. Values that are `out` or `inout` can be changed by the service and those changes will be propagated back to the client. Primitives (e.g., `int`) can only be `in`; we included `in` for the AIDL for `enable()` just for illustration purposes.

Also, you cannot throw any exceptions. You will need to catch all exceptions in your code, deal with them, and return failure indications some other way (e.g., error code return values).

Name your AIDL files with the `.aidl` extension and place them in the proper directory based on the package name.

When you build your project, either via an IDE or via Ant, the `aidl` utility from the Android SDK will translate your AIDL into a server stub and a client proxy.

### Implement the Interface

Given the AIDL-created server stub, now you need to implement the service, either directly in the stub, or by routing the stub implementation to other methods you have already written.

The mechanics of this are fairly straightforward:

1. Create a private instance of the AIDL-generated `.Stub` class (e.g., `IScript.Stub`)
2. Implement methods matching up with each of the methods you placed in the AIDL
3. Return this private instance from your `onBind()` method in the `Service` subclass

Note that AIDL IPC calls are synchronous, and so the caller is blocked until the IPC method returns. Hence, your services need to be quick about their work.

We will see examples of service stubs later in this chapter.

## Service From Afar

So, given our AIDL description, let us examine a sample implementation, using AIDL for a remote service.

Our sample applications — shown in the `AdvServices/RemoteService` and `AdvServices/RemoteClient` sample projects — integrate [BeanShell](#) into a remote service, along the lines of the local binding sample from earlier in this chapter. If you actually wanted to use scripting in an Android application, with scripts loaded off of the Internet, isolating their execution into a service might not be a bad idea. In the

service, those scripts are sandboxed, only able to access files and APIs available to that service. The scripts cannot access your own application's databases, for example. If the script-executing service is kept tightly controlled, it minimizes the mischief a rogue script could possibly do.

### Service Names

To bind to a service's AIDL-defined API, you need to craft an Intent that can identify the service in question. In the case of a local service, that Intent can use the local approach of directly referencing the service class.

Obviously, that is not possible in a remote service case, where the service class is not in the same process, and may not even be known by name to the client.

When you define a service to be used by remote, you need to add an intent-filter element to your service declaration in the manifest, indicating how you want that service to be referred to by clients. The manifest for RemoteService is shown below:

```
<?xml version="1.0" encoding="utf-8"?>
<manifest android:versionCode="1"
  android:versionName="1.0"
  package="com.commonware.android.advservice"
  xmlns:android="http://schemas.android.com/apk/res/android">

  <uses-sdk android:minSdkVersion="3"
    android:targetSdkVersion="6" />
  <supports-screens android:largeScreens="false"
    android:normalScreens="true"
    android:smallScreens="false" />
  <application android:icon="@drawable/cw"
    android:label="@string/app_name">
    <service android:name=".BshService">
      <intent-filter>
        <action android:name="com.commonware.android.advservice.IScript" />
      </intent-filter>
    </service>
  </application>
</manifest>
```

Here, we say that the service can be identified by the name `com.commonware.android.advservice.IScript`. So long as the client uses this name to identify the service, it can bind to that service's API.

In this case, the name is not an implementation, but the AIDL API, as you will see below. In effect, this means that so long as some service exists on the device that implements this API, the client will be able to bind to something.

### The Service

Beyond the manifest, the service implementation is not too unusual. There is the AIDL interface, `IScript`:

```
package com.commonware.android.advservice;

// Declare the interface.
interface IScript {
    void executeScript(String script);
}
```

And there is the actual service class itself, `BshService`:

```
package com.commonware.android.advservice;

import android.app.Service;
import android.content.Context;
import android.content.Intent;
import android.os.IBinder;
import android.util.Log;
import bsh.EvalError;
import bsh.Interpreter;

public class BshService extends Service {
    @Override
    public IBinder onBind(Intent intent) {
        return(new BshBinder(this));
    }

    private static class BshBinder extends IScript.Stub {
        private Interpreter i=new Interpreter();

        BshBinder(Context ctxt) {
            try {
                i.set("context", ctxt);
            }
            catch (EvalError e) {
                Log.e("BshService", "Error executing script", e);
            }
        }

        @Override
        public void executeScript(String script) {
            try {
                i.eval(script);
            }
            catch (bsh.EvalError e) {
                Log.e("BshService", "Error executing script", e);
            }
        }
    }
}
```

```
};  
}
```

This is identical to the local binding example, with one key difference: `BshBinder` now extends `IScript.Stub` rather than the generic `Binder` class.

Also note that, in this implementation, the script is executed directly by the service on the calling thread. One might think this is not a problem, since the service is in its own process and, therefore, cannot possibly be using the client's UI thread. However, AIDL IPC calls are synchronous, so the client will still block waiting for the script to be executed. This too will be corrected later in this chapter.

### The Client

The client — a revised version of `BshFragment` — connects to the remote service to ask it to execute BeanShell scripts on the user's behalf:

```
import android.widget.Button;  
import android.widget.EditText;  
import android.widget.Toast;  
import com.commonware.android.advservice.IScript;  
  
public class BshFragment extends Fragment implements OnClickListener,  
    ServiceConnection {  
    private IScript service=null;  
    private Button btn=null;  
  
    public View onCreateView(LayoutInflater inflater,  
        ViewGroup container,  
        Bundle savedInstanceState) {  
        View result=inflater.inflate(R.layout.main, container, false);  
  
        btn=(Button)result.findViewById(R.id.eval);  
        btn.setOnClickListener(this);  
        btn.setEnabled((service!=null));  
  
        return(result);  
    }  
  
    @Override  
    public void onActivityCreated(Bundle savedInstanceState) {  
        super.onActivityCreated(savedInstanceState);  
  
        setRetainInstance(true);  
        getActivity().getApplicationContext()  
            .bindService(new Intent(  
                "com.commonware.android.advservice.IScript"),  
                this, Context.BIND_AUTO_CREATE);  
    }  
}
```



```
}

@Override
public void onDestroy() {
    getActivity().getApplicationContext().unbindService(this);

    super.onDestroy();
}

@Override
public void onClick(View view) {
    EditText script=(EditText)getView().findViewById(R.id.script);
    String src=script.getText().toString();

    try {
        service.executeScript(src);
    }
    catch (RemoteException e) {
        Toast.makeText(getActivity(), e.toString(), Toast.LENGTH_LONG)
            .show();
    }
}

@Override
public void onServiceConnected(ComponentName className, IBinder binder) {
    service=IScript.Stub.asInterface(binder);
    btn.setEnabled(true);
}

@Override
public void onServiceDisconnected(ComponentName className) {
    service=null;
}
}
```

This is the same as with the local binding scenario, except:

- We use a different Intent with `bindService()`, one identifying the remote service by name
- Our `onServiceConnected()` uses `IScript.Stub.asInterface()` to convert the raw `IBinder` into an `IScript` object for use
- We have to catch a `RemoteException` when we try to call `executeScript()`, in case the service crashed or is otherwise inaccessible at this moment

Note that the client needs its own copy of `IScript.aidl`. After all, it is a totally separate application, and therefore does not share source code with the service. In a production environment, we might craft and distribute a JAR file that contains the `IScript` classes, so both client and service can work off the same definition (see [the](#)

[upcoming chapter on reusable components](#)). For now, we will just have a copy of the AIDL.

If you compile both applications and upload them to the device, then start up the client, you can enter in Beanshell code and have it be executed by the service. Note, though, that you cannot perform UI operations (e.g., raise a Toast) from the service, because in that process, the `executeScript()` method is *not* running on the main application thread. If you choose some script that is long-running, you will see that the “Go!” button is blocked until the script is complete.

## Servicing the Service

The preceding section outlined two flaws in the implementation of the Beanshell remote service:

- The client received no results from the script execution
- The client blocked waiting for the script to complete

If we were not worried about the blocking-call issue, we could simply have the `executeScript()` exported API return some sort of result (e.g., `toString()` on the result of the Beanshell `eval()` call). However, that would not solve the fact that calls to service APIs are synchronous even for remote services.

Another approach would be to pass some sort of callback object with `executeScript()`, such that the server could run the script asynchronously and invoke the callback on success or failure. This, though, implies that there is some way to have the client export an API to the service.

Fortunately, this is eminently doable, as you will see in this section, and the accompanying samples ( [AdvServices/RemoteServiceEx](#) and [AdvServices/RemoteClientEx](#)).

## Callbacks via AIDL

AIDL does not have any concept of direction. It just knows interfaces and stub implementations. In the preceding example, we used AIDL to have the service flesh out the stub implementation and have the client access the service via the AIDL-defined interface. However, there is nothing magic about services implementing and clients accessing — it is equally possible to reverse matters and have the client implement something the service uses via an interface.

So, for example, we could create an `IScriptResult.aidl` file:

```
package com.commonware.android.advservice;

// Declare the interface.
interface IScriptResult {
    void success(String result);
    void failure(String error);
}
```

Then, we can augment `IScript` itself, to pass an `IScriptResult` with `executeScript()`:

```
package com.commonware.android.advservice;

import com.commonware.android.advservice.IScriptResult;

// Declare the interface.
interface IScript {
    void executeScript(String script, IScriptResult cb);
}
```

Notice that we need to specifically import `IScriptResult`, just like we might import some “regular” Java interface. And, as before, we need to make sure the client and the server are working off of the same AIDL definitions, so these two AIDL files need to be replicated across each project.

But other than that one little twist, this is all that is required, at the AIDL level, to have the client pass a callback object to the service: define the AIDL for the callback and add it as a parameter to some service API call.

Of course, there is a little more work to do on the client and server side to make use of this callback object.

### Revising the Client

On the client, we need to implement an `IScriptResult`. On `success()`, we can do something like raise a `Toast`; on `failure()`, we can perhaps show an `AlertDialog`.

The catch is that we cannot be certain we are being called on the UI thread in our callback object.

So, the safest way to do that is to make the callback object use something like `runOnUiThread()` to ensure the results are displayed on the UI thread. And, of

## REMOTE SERVICES AND THE BINDING PATTERN

---

course, we need to update our call to `executeScript()` to pass the callback object to the remote service.

```
package com.commonware.android.advservice.client;

import android.content.ComponentName;
import android.content.Context;
import android.content.Intent;
import android.content.ServiceConnection;
import android.os.Bundle;
import android.os.IBinder;
import android.os.RemoteException;
import android.support.v4.app.Fragment;
import android.view.LayoutInflater;
import android.view.View;
import android.view.View.OnClickListener;
import android.view.ViewGroup;
import android.widget.Button;
import android.widget.EditText;
import android.widget.Toast;
import com.commonware.android.advservice.IScript;
import com.commonware.android.advservice.IScriptResult;

public class BshFragment extends Fragment implements OnClickListener,
    ServiceConnection {
    private IScript service=null;
    private Button btn=null;

    public View onCreateView(LayoutInflater inflater,
        ViewGroup container,
        Bundle savedInstanceState) {
        View result=inflater.inflate(R.layout.main, container, false);

        btn=(Button)result.findViewById(R.id.eval);
        btn.setOnClickListener(this);
        btn.setEnabled((service!=null));

        return(result);
    }

    @Override
    public void onActivityCreated(Bundle savedInstanceState) {
        super.onActivityCreated(savedInstanceState);

        setRetainInstance(true);
        getActivity().getApplicationContext()
            .bindService(new Intent(
"com.commonware.android.advservice.IScript"),
                this, Context.BIND_AUTO_CREATE);
    }

    @Override
```

## REMOTE SERVICES AND THE BINDING PATTERN

---

```
public void onDestroy() {
    getActivity().getApplicationContext().unbindService(this);

    super.onDestroy();
}

@Override
public void onClick(View view) {
    EditText script=(EditText)getView().findViewById(R.id.script);
    String src=script.getText().toString();

    try {
        service.executeScript(src, callback);
    }
    catch (RemoteException e) {
        Toast.makeText(getActivity(), e.toString(), Toast.LENGTH_LONG)
            .show();
    }
}

@Override
public void onServiceConnected(ComponentName className, IBinder binder) {
    service=IScript.Stub.asInterface(binder);
    btn.setEnabled(true);
}

@Override
public void onServiceDisconnected(ComponentName className) {
    service=null;
}

private final IScriptResult.Stub callback=new IScriptResult.Stub() {
    public void success(final String result) {
        getActivity().runOnUiThread(new Runnable() {
            public void run() {
                Toast.makeText(getActivity(), result, Toast.LENGTH_LONG)
                    .show();
            }
        });
    }
};

public void failure(final String error) {
    getActivity().runOnUiThread(new Runnable() {
        public void run() {
            Toast.makeText(getActivity(), error, Toast.LENGTH_LONG)
                .show();
        }
    });
}
};
}
```

### Revising the Service

The service also needs changing, to both execute the scripts asynchronously and use the supplied callback object for the end results of the script's execution.

BshService from AdvServices/RemoteServiceEx uses a ThreadPoolExecutor to manage a background thread. An ExecuteScriptJob wraps up the script and callback; when the job is eventually processed, it uses the callback to supply the results of the eval() (on success) or the message of the Exception (on failure):

```
package com.commonware.android.advservice;

import android.app.Service;
import android.content.Intent;
import android.os.IBinder;
import android.util.Log;
import bsh.Interpreter;
import java.util.concurrent.ExecutorService;
import java.util.concurrent.LinkedBlockingQueue;
import java.util.concurrent.ThreadPoolExecutor;
import java.util.concurrent.TimeUnit;

public class BshService extends Service {
    private final ExecutorService executor=
        new ThreadPoolExecutor(1, 1, 60, TimeUnit.SECONDS,
            new LinkedBlockingQueue<Runnable>());
    private final Interpreter i=new Interpreter();

    @Override
    public void onCreate() {
        super.onCreate();

        try {
            i.set("context", this);
        }
        catch (bsh.EvalError e) {
            Log.e("BshService", "Error executing script", e);
        }
    }

    @Override
    public IBinder onBind(Intent intent) {
        return(new BshBinder());
    }

    @Override
    public void onDestroy() {
        executor.shutdown();

        super.onDestroy();
    }
}
```

```
private class ExecuteScriptJob implements Runnable {
    IScriptResult cb;
    String script;

    ExecuteScriptJob(String script, IScriptResult cb) {
        this.script=script;
        this.cb=cb;
    }

    @Override
    public void run() {
        try {
            cb.success(i.eval(script).toString());
        }
        catch (Throwable e) {
            Log.e("BshService", "Error executing script", e);

            try {
                cb.failure(e.getMessage());
            }
            catch (Throwable t) {
                Log.e("BshService", "Error returning exception to client", t);
            }
        }
    }
}

private class BshBinder extends IScript.Stub {
    @Override
    public void executeScript(String script, IScriptResult cb) {
        executor.execute(new ExecuteScriptJob(script, cb));
    }
};
}
```

Notice that the service's own API just needs the `IScriptResult` parameter, which can be passed around and used like any other Java object. The fact that it happens to cause calls to be made synchronously back to the remote client is invisible to the service.

The net result is that the client can call the service and get its results without tying up the client's UI thread.

You may be wondering why we do not simply use an `AsyncTask`. The reason is that remote service methods exposed by AIDL are not invoked on the main application thread — one of the few places in Android where Android calls your code from a background thread. An `AsyncTask` expects to be created on the main application thread.

## Thinking About Security

Remote services, by definition, are available for anyone to connect to. This may or may not be a good idea.

If the only client of your remote service is some other app of yours, you could protect the service using [a custom signature-level permission](#).

If you anticipate third-party apps communicating with your service, you should strongly consider protecting the service with [an ordinary custom permission](#), so the *user* can vote on whether the communication is allowed.

For local services, the simplest way to secure the service is to not export it, typically by not having an `<intent-filter>` element for the `<service>` in the manifest. Then, your app is the only app that can work with the service.

## The “Everlasting Service” Anti-Pattern

One anti-pattern that is all too prevalent in Android is the “everlasting service”. Such a service is started via `startService()` and never stops — the component starting it does not stop it and it does not stop itself via `stopSelf()`.

Why is this an anti-pattern?

1. The service takes up memory all of the time. This is bad in its own right if the service is not continuously delivering sufficient value to be worth the memory.
2. Users, fearing services that sap their device’s CPU or RAM, may attack the service with so-called “task killer” applications or may terminate the service via the Settings app, thereby defeating your original goal.
3. Android itself, due to user frustration with sloppy developers, will terminate services it deems ill-used, particularly ones that have run for quite some time.

Occasionally, an everlasting service is the right solution. Take a VOIP client, for example. A VOIP client usually needs to hold an open socket with the VOIP server to know about incoming calls. The only way to continuously watch for incoming calls is to continuously hold open the socket. The only component capable of doing that would be a service, so the service would have to continuously run.



## REMOTE SERVICES AND THE BINDING PATTERN

---

However, in the case of a VOIP client, or a music player, the user is the one specifically requesting the service to run forever. By using `startForeground()`, a service can ensure it will not be stopped due to old age for cases like this.

As a counter-example, imagine an email client. The client wishes to check for new email messages periodically. The right solution for this is the `AlarmManager` pattern described [elsewhere in this book](#). The anti-pattern would have a service running constantly, spending most of its time waiting for the polling period to elapse (e.g., via `Thread.sleep()`). There is no value to the user in taking up RAM to watch the clock tick. Such services should be rewritten to use `AlarmManager`.

Most of the time, though, it appears that services are simply leaked. That is one advantage of using `AlarmManager` and an `IntentService` – it is difficult to leak the service, causing it to run indefinitely. In fact, `IntentService` in general is a great implementation to use whenever you use the command pattern, as it ensures that the service will shut down eventually. If you use a regular service, be sure to shut it down when it is no longer actively delivering value to the user.

# Advanced Manifest Tips

---

If you have been diligent about reading this book (versus having randomly jumped to this chapter), you will already have done a fair number of things with your project's `AndroidManifest.xml` file:

1. Used it to define components, like activities, services, content providers, and manifest-registered broadcast receivers
2. Used it to declare permissions your application requires, or possibly to define permissions that other applications need in order to integrate with your application
3. Used it to define what SDK level, screen sizes, and other device capabilities your application requires

In this chapter, we continue looking at things the manifest offers you, starting with a discussion of controlling where your [application gets installed](#) on a device, and wrapping up with a bit of information about [activity aliases](#).

## Prerequisites

Understanding this chapter requires that you have read the core chapters of this book.

## Just Looking For Some Elbow Room

On October 22, 2008, the [HTC Dream](#) was released, under the moniker of “T-Mobile G1”, as the first production Android device.

Complaints about the lack of available storage space for applications probably started on October 23rd.

The Dream, while a solid first Android device, offered only 70MB of on-board flash for application storage. This storage had to include:

1. The Android application (APK) file
2. Any local files or databases the application created, particularly those deemed unsafe to put on the SD card (e.g., privacy)
3. Extra copies of some portions of the APK file, such as the compiled Dalvik bytecode, which get unpacked on installation for speed of access

It would not take long for a user to fill up 70MB of space, then have to start removing some applications to be able to try others.

Users and developers alike could not quite understand why the Dream had so little space compared to the available iPhone models, and they begged to at least allow applications to install to the SD card, where there would be more room. This, however, was not easy to implement in a secure fashion, and it took until Android 2.2 for the feature to become officially available.

Now that it is available, though, let's see how to use it.

### Configuring Your App to Reside on External Storage

Indicating to Android that your application can reside on the SD card is easy... and necessary, if you want the feature. If you do not tell Android this is allowed, Android will *not* install your application to the SD card, nor allow the user to move the application to the SD card.

All you need to do is add an `android:installLocation` attribute to the root `<manifest>` element of your `AndroidManifest.xml` file. There are three possible values for this attribute:

- `internalOnly`, the default, meaning that the application cannot be installed to the SD card
- `preferExternal`, meaning the application would like to be installed on the SD card
- `auto`, meaning the application can be installed in either location

---

## ADVANCED MANIFEST TIPS

---

If you use `preferExternal`, then your application will be initially installed on the SD card in most cases. Android reserves the right to still install your application on internal storage in cases where that makes too much sense, such as there not being an SD card installed at the time.

If you use `auto`, then Android will make the decision as to the installation location, based on a variety of factors. In effect, this means that `auto` and `preferExternal` are functionally very similar – all you are doing with `preferExternal` is giving Android a hint as to your desired installation destination.

Because Android decides where your application is initially installed, and because the user has the option to move your application between the SD card and on-board flash, you cannot assume any given installation spot. The exception is if you choose `internalOnly`, in which case Android will honor your request, at the potential cost of not allowing the installation at all if there is no more room in on-board flash.

For example, here is the manifest from the [SMS/Sender](#) sample project, profiled in [another chapter](#), showing the use of `preferExternal`:

```
<?xml version="1.0" encoding="utf-8"?>
<manifest xmlns:android="http://schemas.android.com/apk/res/android"
    package="com.commonware.android.sms.sender"
    android:installLocation="preferExternal"
    android:versionCode="1"
    android:versionName="1.0">

    <uses-permission android:name="android.permission.READ_CONTACTS"/>
    <uses-permission android:name="android.permission.SEND_SMS"/>

    <uses-sdk
        android:minSdkVersion="7"
        android:targetSdkVersion="11"/>

    <supports-screens
        android:largeScreens="true"
        android:normalScreens="true"
        android:smallScreens="false"/>

    <application
        android:icon="@drawable/ic_launcher"
        android:label="@string/app_name">
        <activity
            android:name="Sender"
            android:label="@string/app_name">
            <intent-filter>
                <action android:name="android.intent.action.MAIN"/>

                <category android:name="android.intent.category.LAUNCHER"/>
            </intent-filter>
        </activity>
    </application>
</manifest>
```

```
        </intent-filter>
    </activity>
</application>
</manifest>
```

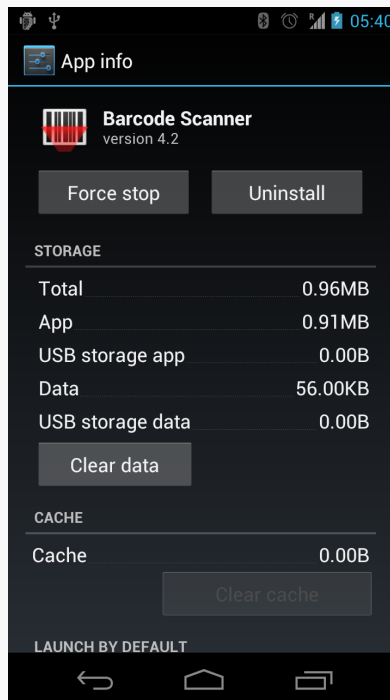
Since this feature only became available in Android 2.2, to support older versions of Android, just have your build tools target API level 8 (e.g., `target=android-8` in `project.properties` for those of you building via Ant, or `Project > Properties > Android` for those of you building with Eclipse) while having your `minSdkVersion` attribute in the manifest state the lowest Android version your application supports overall. Older versions of Android will ignore the `android:installLocation` attribute. So, for example, in the above manifest, the Sender application supports API level 4 and above (Android 1.6 and newer), but still can use `android:installLocation="preferExternal"`, because the build tools are targeting API level 8.

### What the User Sees

For an application that wound up on the SD card, courtesy of your choice of `preferExternal` or `auto`, the user will have an option to move it to the phone's internal storage. This can be done by choosing the application in the Manage Applications list in the Settings application, then clicking the "Move to phone" button:

## ADVANCED MANIFEST TIPS

---



*Figure 414: An application, installed on the SD card*

Conversely, if your application is installed in on-board flash, and it is movable to external storage, they will be given that option:

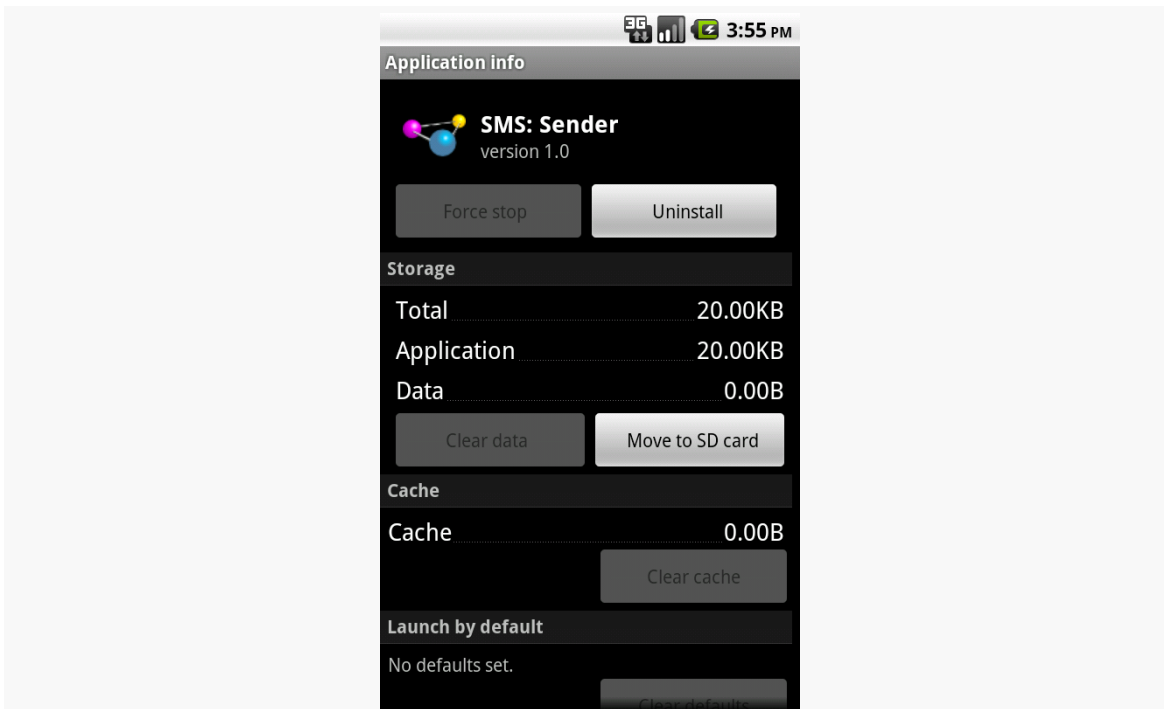


Figure 415: An application, installed on the on-board flash but movable to the SD card

### What the Pirate Sees

Ideally, the pirate sees nothing at all.

One of the major concerns with installing applications to the SD card is that the SD card is usually formatted FAT32 (vfat), offering no protection from prying eyes. The concern was that pirates could then just pluck the APK file off the SD card and distribute it, even for paid apps from the Play Store.

Apparently, they solved this problem.

To quote the [Android developer documentation](#):

The unique container in which your application is stored is encrypted with a randomly generated key that can be decrypted only by the device that originally installed it. Thus, an application installed on an SD card works for only one device.

Moreover, this “unique container” is not normally mounted when the user mounts external storage on their host machine. The user mounts `/mnt/sdcard`; the “unique container” is `/mnt/asec`.

### What Your App Sees... When the Card is Removed

So far, this has all seemed great for users and developers. Developers need to add a single attribute to the manifest, and Android 2.2+ users gain the flexibility of where the app gets stored.

Alas, there is a problem, and it is a big one: on Android 1.x and 2.x, either the host PC or the device can have access to the SD card, but not both. As a result, if the user makes the SD card available to the host PC, by plugging in the USB cable and mounting the SD card as a drive via a Notification or other means, that SD card becomes unavailable for running applications.

So, what happens?

1. First, your application is terminated forcibly, as if your process was being closed due to low memory. Notably, your activities and services will not be called with `onDestroy()`, and instance state saved via `onSaveInstanceState()` is lost.
2. Second, your application is unhooked from the system. Users will not see your application in the launcher, your `AlarmManager` alarms will be canceled, and so on.
3. When the user makes the SD card available to the phone again, your application will be hooked back into the system and will be once again available to the user (for example, your icon will reappear in the launcher)

The upshot: if your application is simply a collection of activities, otherwise not terribly connected to Android, the impact on your application is no different than if the user reboots the phone, kills your process via a so-called “task killer” application, etc. If, however, you are doing more than that, the impacts may be more dramatic.

Perhaps the most dramatic impact, from a user’s standpoint, will be if your application implements app widgets. If the user has your app widget on her home screen, that app widget will be removed when the SD card becomes unavailable to the phone. Worse, your app widget cannot be re-added to the home screen until the phone is rebooted (a limitation that hopefully will be lifted sometime after Android 2.2).



## ADVANCED MANIFEST TIPS

---

The user is warned about this happening, at least in general:



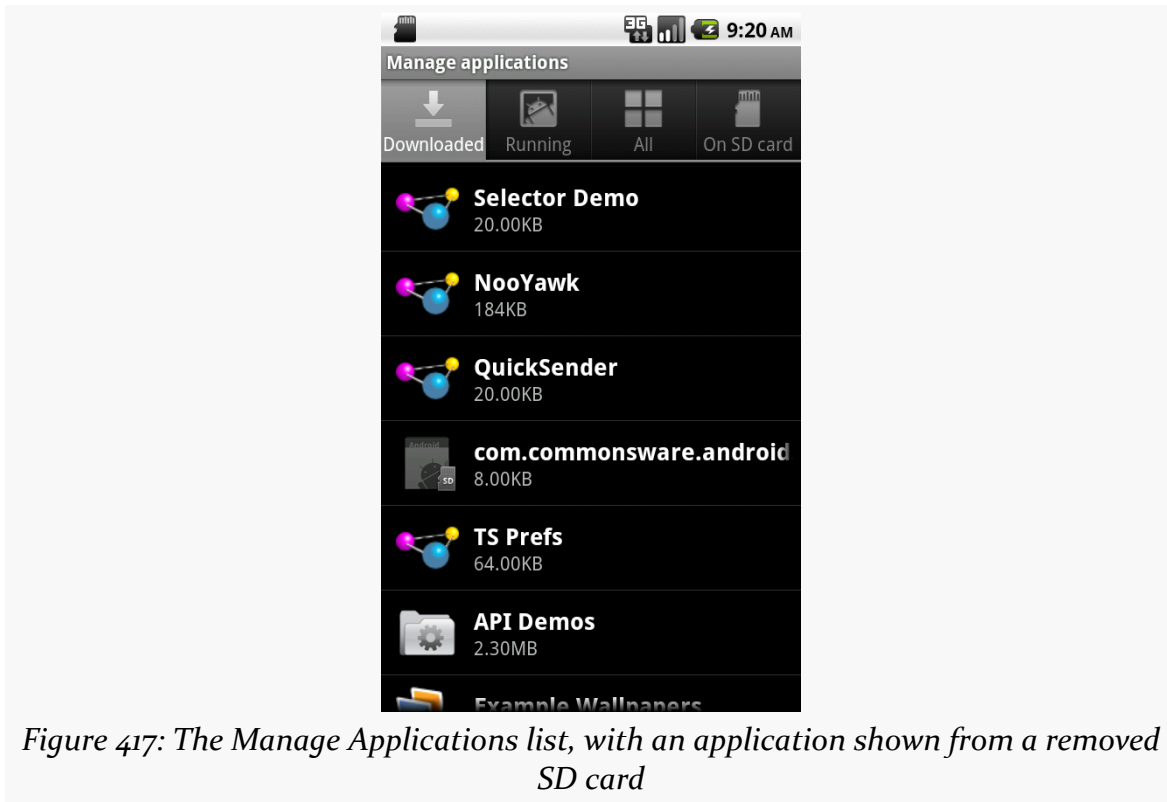
Figure 416: Warning when unmounting the SD card

Two broadcast Intents are sent out related to this:

- ACTION\_EXTERNAL\_APPLICATIONS\_UNAVAILABLE, when the SD card (and applications installed upon it) become unavailable
- ACTION\_EXTERNAL\_APPLICATIONS\_AVAILABLE, when the SD card and its applications return to normal

Note that the documentation is unclear as to whether your own application, that had been on the SD card, can receive ACTION\_EXTERNAL\_APPLICATIONS\_AVAILABLE once the SD card is back in action. There is an [outstanding issue on this topic](#) in the Android issue tracker.

Also note that all of these problems hold true for longer if the user physically removes the SD card from the device. If, for example, they replace the card with a different one — such as one with more space — your application will be largely lost. They will see a note in their applications list for your application, but the icon will indicate it is on an SD card, and the only thing they can do is uninstall it:



### Choosing Whether to Support External Storage

Given the huge problem from the previous section, the question of whether or not your application should support external storage is far from clear.

As the [Android developer documentation](#) states:

Large games are more commonly the types of applications that should allow installation on external storage, because games don't typically provide additional services when inactive. When external storage becomes unavailable and a game process is killed, there should be no visible effect when the storage becomes available again and the user restarts the game (assuming that the game properly saved its state during the normal Activity lifecycle).

Conversely, if your application implements any of the following features, it may be best to not support external storage:

1. Polling of Web services or other Internet resources via a scheduled alarm

2. Account managers and their corresponding sync adapters, for custom sources of contact data
3. App widgets, as noted in the previous section
4. Device administration extensions
5. Live folders
6. Custom soft keyboards (“input method engines”)
7. Live wallpapers
8. Custom search providers

Note that Android 3.0 has placed both internal storage and external storage on the same partition, whereas before they were independent partitions. That partition split is what caused device manufacturers to artificially constrain the amount of internal storage. As a result, `android:installLocation` is not really needed for Android 3.0+ apps, as it does not benefit the user (they do not gain any additional internal storage). Once the Android 2.x series has declined in market share sufficiently, any pressure you may have felt to support installing on external storage should evaporate.

## Using an Alias

As was mentioned in the [chapter on integration](#), you can use the `PackageManager` class to enable and disable components in your application. This works at the component level, meaning you can enable and disable activities, services, content providers, and broadcast receivers. It does not support enabling or disabling individual `<intent-filter>` stanzas from a given component, though.

Why might you want to do this?

1. Perhaps you have an activity you want to be available for use, but not necessarily available in the launcher, depending on user configuration or unlocking “pro” features or something
2. Perhaps you want to add browser support for certain MIME types, but only if other third-party applications are not already installed on the device

While you cannot control individual `<intent-filter>` stanzas directly, you can have a similar effect via an activity alias.

An activity alias is another manifest element — `<activity-alias>` — that provides an alternative set of filters or other component settings for an already-defined

## ADVANCED MANIFEST TIPS

---

activity. For example, here is the `AndroidManifest.xml` file from the [Manifest/Alias](#) sample project:

```
<?xml version="1.0" encoding="utf-8"?>
<manifest android:versionCode="1"
  android:versionName="1.0"
  package="com.commonware.android.alias"
  xmlns:android="http://schemas.android.com/apk/res/android">

  <supports-screens android:largeScreens="true"
    android:normalScreens="true"
    android:smallScreens="false" />
  <application android:icon="@drawable/cw"
    android:label="@string/app_name">
    <activity android:label="@string/app_name"
      android:name="AliasActivity">
      <intent-filter>
        <action android:name="android.intent.action.MAIN" />
        <category android:name="android.intent.category.LAUNCHER" />
      </intent-filter>
    </activity>
    <activity-alias android:label="@string/app_name2"
      android:name="ThisIsTheAlias"
      android:targetActivity="AliasActivity">
      <intent-filter>
        <action android:name="android.intent.action.MAIN" />
        <category android:name="android.intent.category.LAUNCHER" />
      </intent-filter>
    </activity-alias>
  </application>
</manifest>
```

Here, we have one `<activity>` element, with an `<intent-filter>` to put the activity in the launcher. We also have an `<activity-alias>` element... which puts a second icon in the launcher for the same activity implementation.

An activity alias can be enabled and disabled independently of its underlying activity. Hence, you can have one activity class have several independent sets of intent filters and can choose which of those sets are enabled at any point in time.

For testing purposes, you can also enable and disable these from the command line. Use the `adb shell pm disable` command to disable a component:

```
adb shell pm disable
com.commonware.android.alias/com.commonware.android.alias.ThisIsTheAlias
```

... and the corresponding `adb shell pm enable` command to enable a component:

## ADVANCED MANIFEST TIPS

---

```
adb shell pm enable  
com.commonware.android.alias/com.commonware.android.alias.ThisIsTheAlias
```

In each case, you supply the package of the application (com.commonware.android.alias) and the class of the component to enable or disable (com.commonware.android.alias.ThisIsTheAlias), separated by a slash.

# Miscellaneous Integration Tips

---

This chapter is a collection of other miscellaneous integration and introspection tips and techniques that you might find useful in your Android apps.

## Prerequisites

Understanding this chapter requires that you have read the core chapters of this book.

## Take the Shortcut

Another way to integrate with Android is to offer custom shortcuts. Shortcuts are available from the home screen. Whereas app widgets allow you to draw on the home screen, shortcuts allow you to wrap a custom Intent with an icon and caption and put that on the home screen. You can use this to drive users not just to your application's "front door", like the launcher icon, but to some specific capability within your application, like a bookmark.

In our case, in the [Introspection/QuickSender](#) sample project, we will allow users to create shortcuts that use ACTION\_SEND to send a pre-defined message, either to a specific address or anywhere, as we have seen [before in this chapter](#).

Once again, the key is in the intent filter.

## Registering a Shortcut Provider

Here is the manifest for QuickSender:

```
<?xml version="1.0" encoding="utf-8"?>
<manifest android:versionCode="1"
    android:versionName="1.0"
    package="com.commonware.android.qsender"
    xmlns:android="http://schemas.android.com/apk/res/android">

    <supports-screens android:largeScreens="true"
        android:normalScreens="true"
        android:smallScreens="false" />
    <application android:icon="@drawable/cw"
        android:label="@string/app_name">
        <activity android:label="@string/app_name"
            android:name="QuickSender">
            <intent-filter>
                <action android:name="android.intent.action.CREATE_SHORTCUT" />
                <category android:name="android.intent.category.DEFAULT" />
            </intent-filter>
        </activity>
    </application>
</manifest>
```

Our single activity does not implement a traditional launcher `<intent-filter>`. Rather, it has one that watches for a `CREATE_SHORTCUT` action. This does two things:

- It means that our activity will show up in the list of possible shortcuts a user can configure
- It means this activity will be the recipient of a `CREATE_SHORTCUT` Intent if the user chooses this application from the shortcuts list

### Implementing a Shortcut Provider

The job of a shortcut-providing activity is to:

1. Create an Intent that will be what the shortcut launches
2. Return that Intent and other data to the activity that started the shortcut provider
3. Finally, `finish()`, so the caller gets control

You can see all of that in the `QuickSender` implementation:

```
package com.commonware.android.qsender;

import android.app.Activity;
import android.content.Intent;
import android.os.Bundle;
import android.text.TextUtils;
import android.view.View;
import android.widget.TextView;
```

## MISCELLANEOUS INTEGRATION TIPS

---

```
public class QuickSender extends Activity {
    @Override
    public void onCreate(Bundle savedInstanceState) {
        super.onCreate(savedInstanceState);
        setContentView(R.layout.main);
    }

    public void save(View v) {
        Intent shortcut=new Intent(Intent.ACTION_SEND);
        TextView addr=(TextView)findViewById(R.id.addr);
        TextView subject=(TextView)findViewById(R.id.subject);
        TextView body=(TextView)findViewById(R.id.body);
        TextView name=(TextView)findViewById(R.id.name);

        if (!TextUtils.isEmpty(addr.getText())) {
            shortcut.putExtra(Intent.EXTRA_EMAIL, addr.getText().toString());
        }

        if (!TextUtils.isEmpty(subject.getText())) {
            shortcut.putExtra(Intent.EXTRA_SUBJECT, subject.getText().toString());
        }

        if (!TextUtils.isEmpty(body.getText())) {
            shortcut.putExtra(Intent.EXTRA_TEXT, body.getText().toString());
        }

        shortcut.setType("text/plain");

        Intent result=new Intent();

        result.putExtra(Intent.EXTRA_SHORTCUT_INTENT, shortcut);
        result.putExtra(Intent.EXTRA_SHORTCUT_NAME,
            name.getText().toString());
        result.putExtra(Intent.EXTRA_SHORTCUT_ICON_RESOURCE,
            Intent.ShortcutIconResource.fromContext(
                this,
                R.drawable.icon));

        setResult(RESULT_OK, result);
        finish();
    }
}
```

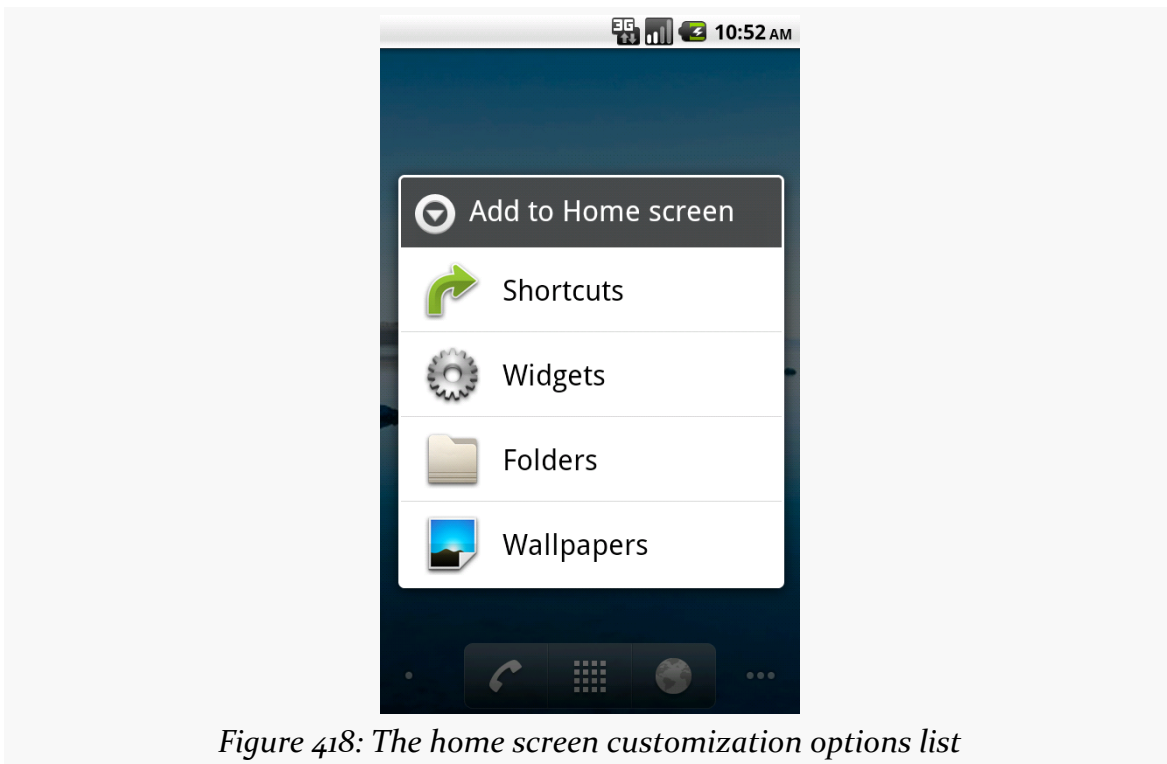
The shortcut Intent is the one that will be launched when the user taps the shortcut icon on the home screen. The result Intent packages up shortcut plus the icon and caption, where the icon is converted into an Intent.ShortcutIconResource object. That result Intent is then used with the setResult() call, to pass that back to whatever called startActivityForResult() to open up QuickSender. Then, we finish().



At this point, all the information about the shortcut is in the hands of Android (or, more accurately, the home screen application), which can add the icon to the home screen.

### Using the Shortcuts

To create a custom shortcut using QuickSender, long-tap on the background of the home screen to bring up the customization options:

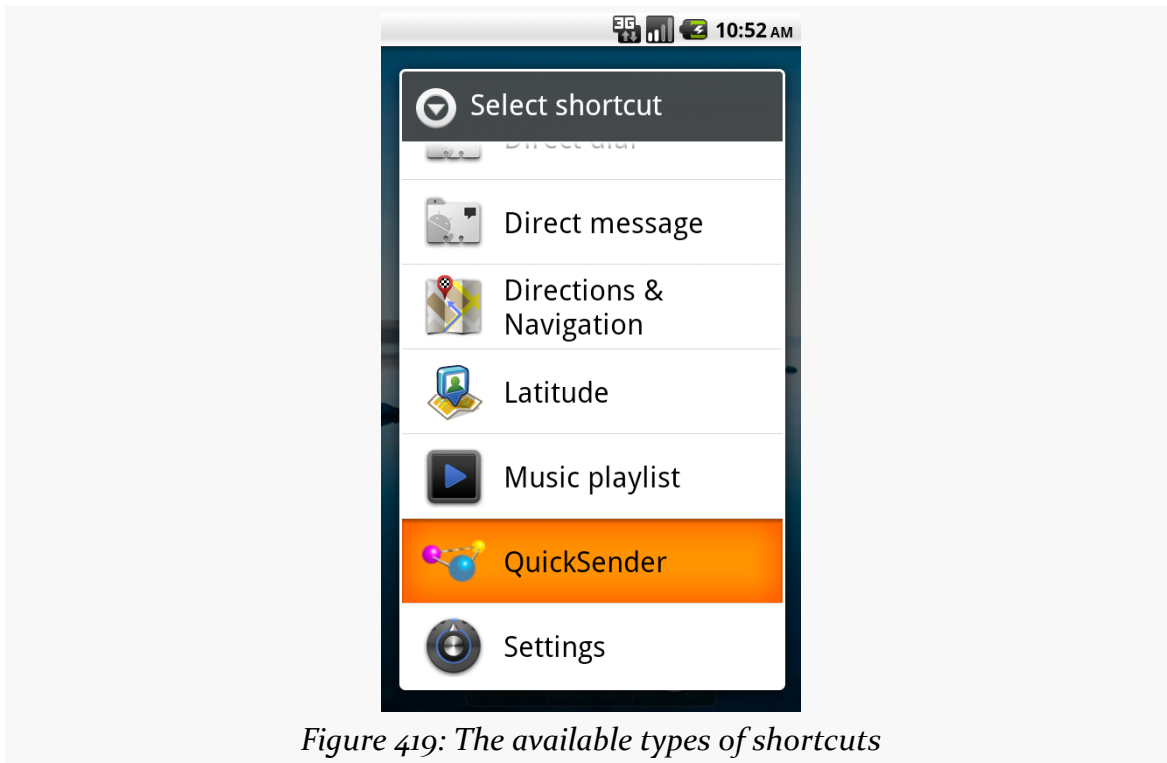


*Figure 418: The home screen customization options list*

Choose Shortcuts, and scroll down to find QuickSender in the list:

## MISCELLANEOUS INTEGRATION TIPS

---

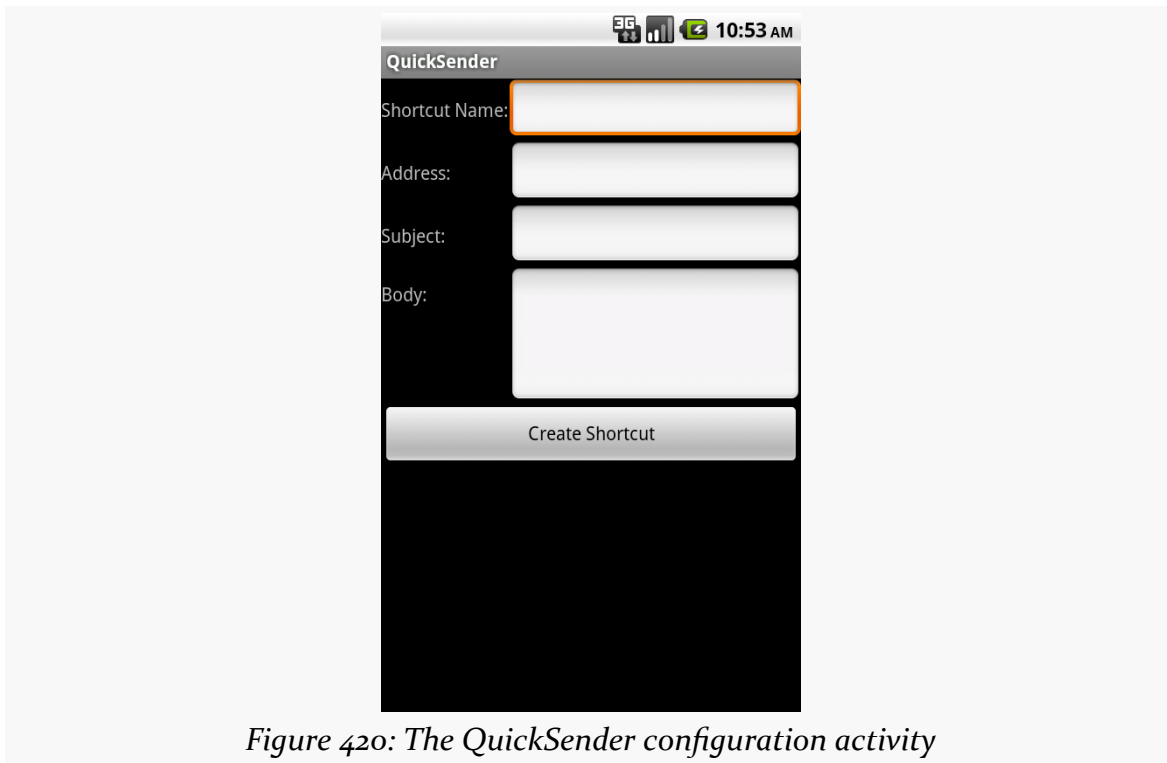


*Figure 419: The available types of shortcuts*

Click the QuickSender entry, which will bring up our activity with the form to define what to send:

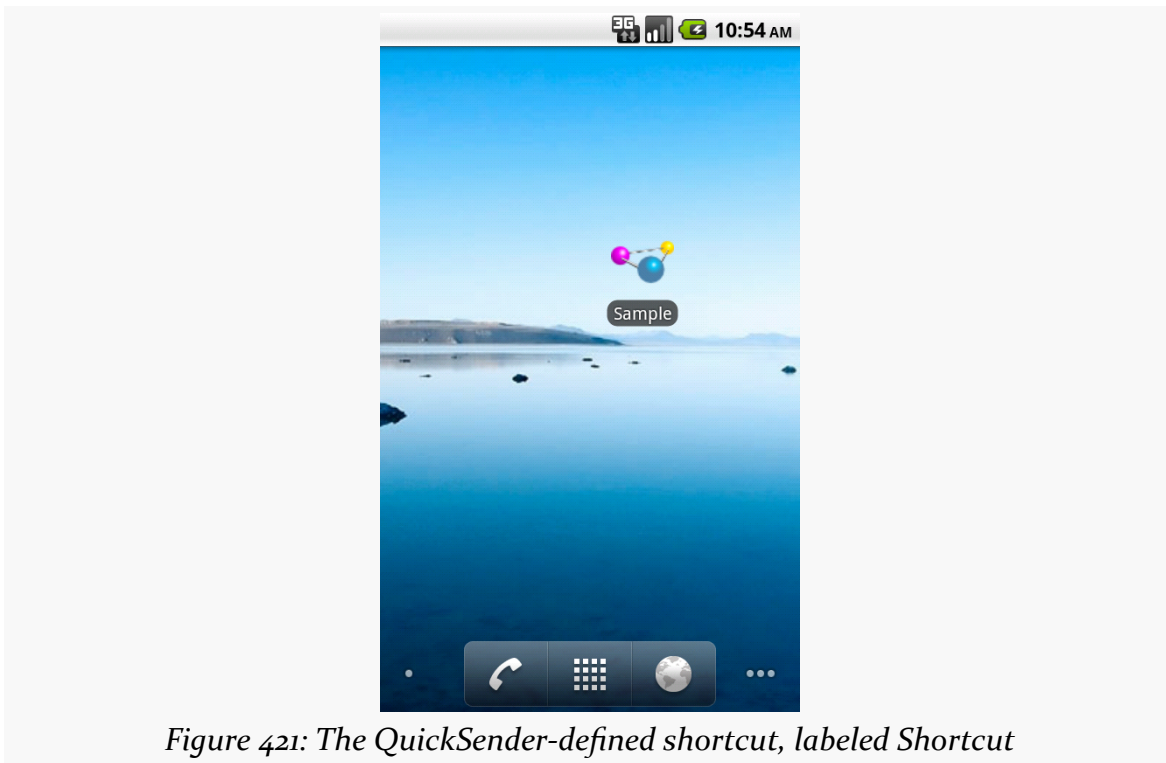
## MISCELLANEOUS INTEGRATION TIPS

---



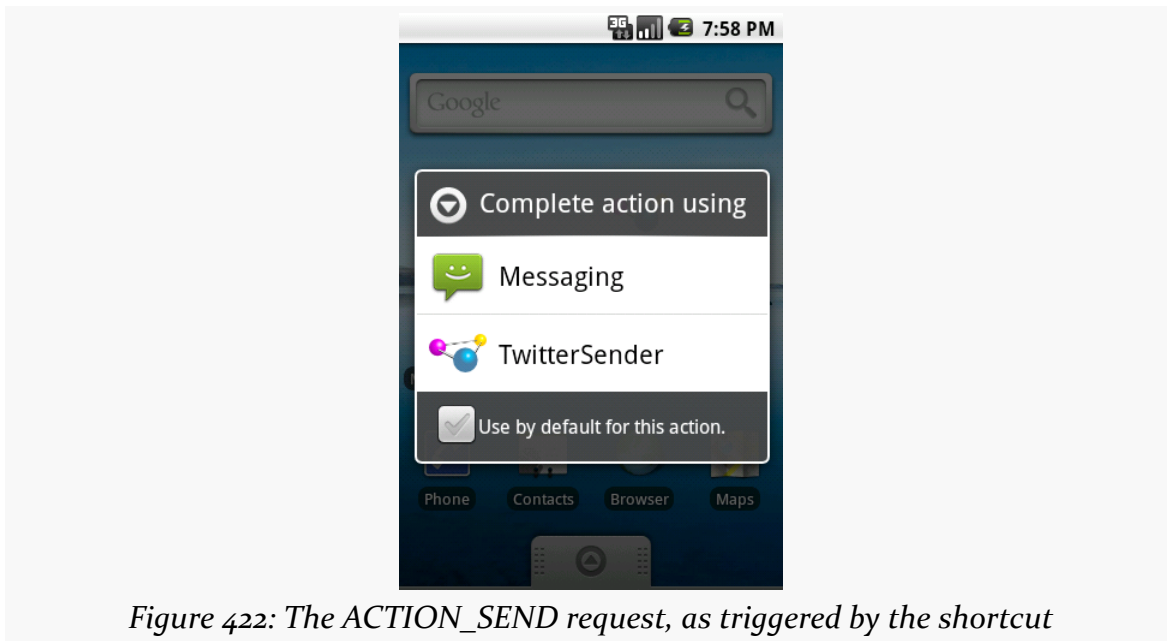
*Figure 420: The QuickSender configuration activity*

Fill in the name, either the subject or body, and optionally the address. Then, click the Create Shortcut button, and you will find your shortcut sitting on your home screen:



*Figure 421: The QuickSender-defined shortcut, labeled Shortcut*

If you launch that shortcut, and if there is more than one application on the device set up to handle `ACTION_SEND`, Android will bring up a special chooser, to allow you to not only pick how to send the message, but optionally make that method the default for all future requests:



Depending on what you choose, of course, will dictate how the message actually gets sent.

## Homing Beacons for Intents

If you are encountering problems with Intent resolution — you create an Intent for something and try starting an Activity or Service with it, and it does not work — you can add the `FLAG_DEBUG_LOG_RESOLUTION` flag to the Intent. This will dump information to LogCat about how the Intent resolution occurred, so you can better diagnose what might be going wrong.

## ShareActionProvider

[Earlier in this book](#), we saw how you can bring up a chooser when using `startActivity()` on an implicit Intent action, such as `ACTION_SEND`.

And, [earlier in this book](#), we saw how `PackageManager` and methods like `queryIntentActivities()` can be used to create your own means for the user to choose some implementation of an implicit Intent action, such as how a home screen lets the user choose an implementation of `ACTION_MAIN`.

## MISCELLANEOUS INTEGRATION TIPS

---

Nowadays, there is another option, if you are using the action bar (native or via ActionBarSherlock): ShareActionProvider. Designed for use with ACTION\_SEND, ShareActionProvider supplies a drop-down menu in the action bar to let the user invoke some implementation of an Intent that you configure and supply.

To see how you can add a ShareActionProvider to your activity or fragment, let us take a look at the [ActionBar/Share](#) sample project.

Our activity — MainActivity — will utilize the action bar, in this case via ActionBarSherlock. Its action bar items are contained in a res/menu/actions.xml file:

```
<?xml version="1.0" encoding="utf-8"?>
<menu xmlns:android="http://schemas.android.com/apk/res/android">

    <item
        android:id="@+id/share"

        android:actionProviderClass="com.actionbarsherlock.widget.ShareActionProvider"
        android:showAsAction="ifRoom"/>

</menu>
```

In addition to specifying an ID and indicating that the item should always be shown in the action bar, we also include the android:actionProviderClass attribute. This points to a concrete implementation of the ActionProvider abstract base class, which is responsible for rendering the action bar item. In our case, we are using ShareActionProvider, specifically the one from ActionBarSherlock. There is an equivalent class for the native action bar in the Android SDK, should you be developing without ActionBarSherlock.

Our activity UI is simply a large EditText widget:

```
<EditText xmlns:android="http://schemas.android.com/apk/res/android"
    android:id="@+id/editor"
    android:layout_width="match_parent"
    android:layout_height="match_parent"
    android:gravity="left|top"
    android:inputType="textMultiLine"/>
```

We load that layout in onCreate() of MainActivity, along with initializing an Intent to be used when we employ the ShareActionProvider:

```
package com.commonware.android.sap;

import android.content.Intent;
```

## MISCELLANEOUS INTEGRATION TIPS

---

```
import android.os.Bundle;
import android.text.Editable;
import android.text.TextWatcher;
import android.widget.EditText;
import android.widget.Toast;
import com.actionbarsherlock.app.SherlockFragmentActivity;
import com.actionbarsherlock.view.Menu;
import com.actionbarsherlock.view.MenuInflater;
import com.actionbarsherlock.widget.ShareActionProvider;

public class MainActivity extends SherlockFragmentActivity implements
    ShareActionProvider.OnShareTargetSelectedListener, TextWatcher {
    private ShareActionProvider share=null;
    private Intent shareIntent=new Intent(Intent.ACTION_SEND);
    private EditText editor=null;

    @Override
    public void onCreate(Bundle icle) {
        super.onCreate(icle);
        setContentView(R.layout.activity_main);

        shareIntent.setType("text/plain");
        editor=(EditText)findViewById(R.id.editor);
        editor.addTextChangedListener(this);
    }

    @Override
    public boolean onCreateOptionsMenu(Menu menu) {
        new MenuInflater(this).inflate(R.menu.actions, menu);

        share=
            (ShareActionProvider)menu.findItem(R.id.share)
                .getActionProvider();
        share.setOnShareTargetSelectedListener(this);

        return(super.onCreateOptionsMenu(menu));
    }

    @Override
    public boolean onShareTargetSelected(ShareActionProvider source,
        Intent intent) {
        Toast.makeText(this, intent.getComponent().toString(),
            Toast.LENGTH_LONG).show();

        return(false);
    }

    @Override
    public void afterTextChanged(Editable s) {
        shareIntent.putExtra(Intent.EXTRA_TEXT, editor.getText());
        share.setShareIntent(shareIntent);
    }

    @Override
```

## MISCELLANEOUS INTEGRATION TIPS

---

```
public void beforeTextChanged(CharSequence s, int start, int count,
                             int after) {
    // ignored
}

@Override
public void onTextChanged(CharSequence s, int start, int before,
                          int count) {
    // ignored
}
}
```

We also register the activity itself to be a `TextWatcher`, to find out when the user types something into the `EditText` widget.

`onOptionsItemSelected()` is where we configure the `ShareActionProvider`, which we obtain by calling `findItem()` on our `Menu` to get the item associated with the provider, then calling `getActionProvider()` on the supplied `MenuItem`. Specifically:

- We supply an `Intent` — configured with the action, MIME type, etc. that we wish to invoke — to `setShareIntent()`
- We supply `MainActivity` itself, as an implementation of `OnShareTargetSelectedListener`, via `setOnShareTargetSelectedListener()`

In the `afterTextChanged()` method needed by the `TextWatcher` interface, we update the `EXTRA_TEXT` extra in the `Intent` to be the current contents of the `EditText`. This way, as the user types, we keep the `Intent` “fresh” with respect to what should be shared. Many consumers of a `ShareActionProvider` will have less dynamic contents, in which case you can just set up the `Intent` up front before you register it with the `ShareActionProvider`.

If the user chooses an item from the `ShareActionProvider`, we are notified via a call to our `onShareTargetSelected()` method. Registering as the `OnShareTargetSelectedListener` is optional — Android will automatically start the selected activity without our involvement. `onShareTargetSelected()` is there if you wish to know the means of sharing that the user chose. In our case, we just flash a `Toast` to indicate that the callback worked.





# Reusable Components

---

In the world of Java outside of Android, reusable components rule the roost. Whether they are simple JARs, are tied in via inversion-of-control (IoC) containers like [Spring](#), or rely on enterprise service buses like [Mule](#), reusable Java components are a huge portion of the overall Java ecosystem. Even full-fledged applications, like [Eclipse](#) or [NetBeans](#), are frequently made up of a number of inter-locking components, many of which are available for others to use in their own applications.

In an ideal world, Android will evolve similarly, particularly given its reliance upon the Java programming language. This raises the question: what are the best ways to package code into a reusable component? Or, perhaps more basic: what are the possibilities for making reusable components?

## Prerequisites

Understanding this chapter requires that you have read the core chapters, particularly the [one on JARs and library projects](#) [chap-library](#).

## Pick Up a JAR

A Java JAR is simplicity incarnate: a ZIP archive of classes compiled to bytecode. While the JAR as a packaging method is imperfect — dealing with dependencies can be no fun — it is still a very easy way to bundle Java logic into a discrete item that can be uploaded, downloaded, installed, integrated, and used.

Android introduces a seemingly vast number of challenges, though.

### The JAR Itself

Packaging up a set of Java code into a JAR is very straightforward, even if that Java code refers to Android APIs. Whether you use the `jar` command directly, the `<jar>` task in an Ant script, or the equivalent in Eclipse, you just package up the class files as you normally would.

For example, here is an Ant task that creates a JAR for an Android project:

```
<target name="jar" depends="compile">
  <jar
    destfile="bin/CWAC-MergeAdapter.jar"
    basedir="bin/classes"
  />
</target>
```

To create a project that targets a JAR file, just create a regular Android project (e.g., `android create project` or the Eclipse new-project wizard), but ignore the options to build an APK. Just compile the code and put it in the JAR.

Note that the JAR will contain Java class files, meaning Java bytecode. The reuser of your JAR will put your JAR into their project (e.g., in the `libs/` directory), and their project will convert your JAR'd classes into Dalvik bytecode as part of building their APK.

### Resources

The JAR can take care of your Java code. And if all you need is Java code, reuse via JAR file is extremely easy.

Android code often uses other things outside of Java code, and that is where the problems crop up. The most prominent of these “other things” are resources: layouts, bitmaps, menus, preferences, custom view attributes, etc.

Android projects expect these resources to be in the project's own `res/` directory, and there is no facility to get these resources from anywhere else. That causes some problems.

### Packaging and Installing

First, you are going to need to package up the resources you want to ship and to distribute them along with your JAR. You could try to package them in the JAR itself, or you could put the JAR and resources into some larger container, like a ZIP file.

The people reusing your code will need to not only add the JAR to their projects, but also unpack those shipped resources (in their respective resource sets) and put them in their projects as well.

### Naming

The act of unpacking those resources and putting them in a project leads to potential naming conflicts. If you have a layout named `main.xml` and the project already has a layout named `main.xml`, somebody loses.

Hence, when you write your reusable code, you will want to adopt a naming convention that “ensures” all your resource names are going to be unique. Of course, you have no true way of absolutely ensuring that they will be unique, but you can substantially increase your odds. One approach is to prefix all names with something distinctive for your project.

Note that the “names” will be filenames for file-based resources (layouts, drawables, etc.) and the values of `android:name` attributes for element-based resources (strings, dimensions, colors, etc.).

Also note that `android:id` values do not have to be unique, as Android is already set up to support the notion of multiple distinct uses of an ID.

### ID Lookup

Complicating matters further is that even if your build process generates an `R.java` file, the resource identifiers encoded in that file will be different in your project than in the reuser’s project. Hence, you cannot refer to resources via `R.` references, like you would in a regular Android application.

If all your resources have simple integer identifiers, you can use the `getIdentifier()` method on the `Resources` class to convert between a string representation of the resource identifier and the actual identifier itself. This uses

reflection, and so is not fast. You should strongly consider caching these values to minimize the number of reflection calls.

However, at least one type of resource does not have a simple integer resource identifier — custom view attributes. `R.styleable.foo` is an `int[]`, not an `int`. `getIdentifier()` will only work with an integer resource identifier. Your alternative is to do the reflection directly, or find some existing code that will handle that for you, so you can get at the `int[]` that you need.

### Customizing and Overriding

Bear in mind that the reuser of your project may wish to change some things. Perhaps your bitmaps clash with their desired color scheme. Perhaps you did not ship string resources in all desired translations. Perhaps your context menu needs some more items.

There are two ways you can support such modifications. One is to tell the reusers to modify their copy of the resources they unpacked into their projects. This has the advantage of not requiring any particular code changes on your part. However, it may make support more difficult — perhaps some of the modifications they make accidentally break things, and you may have a tough time answering questions about a modified code base.

The alternative is for you to support setters, custom view attributes, or similar means for reusers to supply their own resource identifiers for you to use. Where they give you one, use it; where they do not, use the resource you shipped. This adds to your project's code but may offer a cleaner customization model for reusers.

### Assets

Assets — files in `assets/` in an Android project — will have some of the same issues as do resources:

1. You need to package and distribute those assets
2. Reusers need to unpack those assets into their projects
3. You have to take steps to prevent name collisions (e.g., use a directory in `assets/` likely to be unique to your project)
4. Potentially, reusers may want to use a different asset than the one you shipped

Since assets are accessed by a string name, rather than a generated resource ID, at least you do not have to worry about that particular issue, as you would with a raw resource.

### Manifest Entries

If your reusable code ships activities, services, content providers, or broadcast receivers, reusers of your code will need to add entries for your components in their `AndroidManifest.xml` file. Similarly, if you require certain permissions, or certain hardware features, you will have other manifest entries (e.g., `<uses-permission>`) that will be needed in a reusing project's manifest.

You can handle this by supplying a sample manifest and providing instructions for what pieces of it need to be merged into the reuser's own manifest.

### AIDL Interfaces

If you are shipping a `Service` in your JAR, and if that `Service` is supposed to allow remote access via AIDL, you will need to ship the AIDL file(s) with the JAR itself. Those files will be needed by consumers of the `Service`, even if the developer integrating the JAR itself might not need those files.

This pattern — a JAR containing a remote `Service` — is probably going to be unusual. More likely, a remote `Service` will be packaged as part of an application in an APK file, rather than via a JAR.

### Permissions

Your code may require certain Android permissions in order to succeed, such as needing `WAKE_LOCK` to use a `WakeLock`, or needing `INTERNET`, or whatever. Unfortunately, you cannot specify permissions in a JAR file, so you will need to make sure that reusers of your JAR correctly add the permissions you require, or find ways to gracefully degrade what you do when those permissions are missing.

You can see if the hosting project requested your permission by using `checkPermission()` on `PackageManager`:

```
int result=getPackageManager()  
.checkPermission("android.permission.WAKE_LOCK",
```

## REUSABLE COMPONENTS

---

```
getPackageName());  
  
if (PackageManager.PERMISSION_DENIED==result) {  
    // do something  
}
```

If it did not, what you do is up to the way your API is designed and how you want to handle such problems:

1. You could throw a `RuntimeException`. Since developers will encounter this problem during development, this should not harm their production application.
2. You could return `false` or `null` or some other “didn’t work” return value from a method. For example, you could design an API that allows developers to check if a certain feature is available, then return `false` from that method.
3. You could ignore the problem and let the Android-generated `RuntimeException` handle it. However, this may not be as friendly to your reusers as might throwing your own `RuntimeException`.
4. You could throw a regular checked exception if you prefer (e.g., a custom `PermissionMissingException`), though that requires extra `try/catch` blocks in the reuser’s code for what should only be a configuration error in their project’s manifest.

### Other Source Code

You may have Java source beyond the actual reusable classes themselves, such as sample code demonstrating how to reuse the JAR and related files. You will need to consider how you wish to distribute this code, as part of the actual component package (e.g., ZIP) or via separate means (e.g., git repository).

### Your API

Your reusable code should be exposing an API for reusing projects to call. Most times, if you are packaging code as a JAR, that API will be in the form of Java classes and methods.

### Public versus Non-Public

Those classes and methods will need to be public, as you want the reusing project to reside in its own Java package, not yours.

This means that your black-box test suite (if you have one) and sample code (if you offer any) really should be in separate Java packages as well, so you test and demonstrate the public API. Otherwise, you may accidentally access package-protected classes and methods.

### **Flexibility versus Maintainability**

As with any body of reusable code, you are going to have to consider how much you want to actually implement. The more features and options you provide, the more flexible your reusable code will be for reusers. However, the more features and options you provide, the more complex your reusable code becomes, increasing maintainability costs over time.

This is particularly important when it comes to the public API. Ideally, your public API expands in future releases but does not eliminate or alter the API that came before it. Otherwise, when you ship an updated JAR, your reusers' projects will break, making them unhappy with you and your code.

### **Documentation**

If you are expecting people to reuse your code, you are going to have to tell them how to do that. Usually, these sorts of packages ship documentation with them, sometimes a clone of what is available online. That way, developers can choose the local or hosted edition of the documentation as they wish.

Note that generated documentation (e.g., Javadocs) may still need to be shipped or otherwise supplied to reusers, if you are not providing the source code in the package. Without the source code, reusers cannot regenerate the Javadocs.

### **Licensing**

Your reusable code should be accompanied by adequate licensing information.

### **Your License**

The first license you should worry about is your own. Is your component open source? If so, you will want to ship a license file containing those terms. If your component is not open source, make sure there is a license agreement shipped with the component that lets the reuser know the terms of use.



Bear in mind that not all of your code necessarily has to have the same license. For example, you might have a proprietary license for the component itself, but have sample code be licensed under Apache License 2.0 for easy copy-and-paste.

### Third-Party License Impacts

You may need to include licenses for third party libraries that you have to ship along with your own JAR. Obviously, those licenses would need to give you redistribution rights — otherwise, you cannot ship those libraries in the first place.

Sometimes, the third party licenses will impact your project more directly, such as:

1. Incorporating a GPL library may require your project to be licensed under the same license
2. Adding support for Facebook data may require you to limit your API or require reusers to supply API access keys, since you probably do not have rights to redistribute Facebook data

## A Private Library

The “r6” version of the Android SDK introduced the “library project”. This offers a form of reuse, to share a chunk of code between projects. It is specifically aimed at developers or teams creating multiple applications from the same code base. Perhaps the most popular occurrence of this pattern is the “paid/free” application pair: two applications, one offered for free, one with richer functionality that requires a payment. Via a library project, the common portions of those two applications can be consolidated, even if those “common portions” include things like resources.

The library project support is [integrated into Eclipse](#), though you can create [library projects for use via Ant](#) as well.

### Creating a Library Project

An Android library project, in many respects, looks like a regular Android project. It has source code and resources. It has a manifest. It supports third-party JAR files (e.g., `libs/`).

What it does not do, though, is build an APK file. Instead, it represents a basket of programming assets that the Android build tools know how to blend in with a regular Android projects.

To create a library project in Eclipse, start by creating a normal Android project. Then, in the project properties window (e.g., right-click on the project and choose Properties), in the Android area, check the “Is Library” checkbox. Click [Apply], and you are done.

To create a library project for use with Ant, you can use the `android create lib-project` command. This has the net effect of putting an `android.library=true` entry in your project’s `default.properties` file.

### Using a Library Project

Once you have a library project, you can attach it to a regular Android project, so the regular Android project has access to everything in the library.

To do this in Eclipse, go into the project properties window (e.g., right-click on the project and choose Properties). Click on the Android entry in the list on the left, then click the [Add] button in the Library area. This will let you browse to the directory where your library project resides. You can add multiple libraries and control their ordering with the [Up] and [Down] buttons, or remove a library with the [Remove] button.

For developing using Ant, you can use `android update lib-project` command. This adds an entry like `android.library.reference.1=...` to your project’s `default.properties` file, where `...` is the relative path to your library project. You can add several such libraries, controlling their ordering via the numeric suffix at the end of each property name (e.g., 1 in the previous example).

Now, if you build the main project, the Android build tools will:

1. Include the `src/` directories of the main project and all of the libraries in the source being compiled.
2. Include all of the resources of the projects, with the caveat that if more than one project defines the same resource (e.g., `res/layout/main.xml`), the highest priority project’s resource is included. The main project is top priority, and the priority of the remainder are determined by their order as defined in Eclipse or `default.properties`.

This means you can safely reference R. constants (e.g., `R.layout.main`) in your library source code, as at compile time it will use the value from the main project's generated R class(es).

### Limitations of Library Projects

While library projects are useful for code organization and reuse, they do have their limits, such as:

1. As noted above, if more than one project (main plus libraries) defines the same resource, the higher-priority project's copy gets used. Generally, that is a good thing, as it means that the main project can replace resources defined by a library (e.g., change icons). However, it does mean that two libraries might collide. It is important to keep your resource names distinct.
2. While you can define entries in the manifest file for a library, at present, they do not appear to be used.
3. AIDL files defined in a library will not be picked up by the main project.
4. While resources from libraries are put into the main project's APK, assets defined in a library's `assets/` directory are not.
5. One library cannot depend on another library. You can either produce or consume a library, but not both.

# The Role of Scripting Languages

---

A scripting language, for the purpose of this book, has two characteristics:

1. It is interpreted from source and so does not require any sort of compilation step
2. It cannot (presently) be used to create a full-fledged Android application without at least some form of custom Java-based stub, and probably much more than that

In this part of the book, we will look at scripting languages on Android and what you can accomplish with them, despite any limitations inherent in their collective definition.

## Prerequisites

Understanding this chapter requires that you have read the core chapters of this book.

## All Grown Up

Interpreted languages have been a part of the programming landscape for decades. The language most associated with the desktop computer revolution — BASIC — was originally an interpreted language. However, the advent of MS-DOS and the IBM PC (and clones) led developers in the direction of C for “serious programming”, for reasons of speed. While interpreted languages continued to evolve, they tended to be described as “scripting” languages, used to glue other applications together. Perl, Python, and the like were not considered “serious” contenders for application development.

The follow-on revolution, for the Internet, changed all of that. Most interactive Web sites were written as CGI scripts using these “toy” languages, Perl first and foremost. Even in environments where Perl was unpopular, such as Windows, Web applications were still written using scripting languages, such as VBScript in Active Server Pages (ASP). While some firms developed Web applications using C/C++, scripting languages ruled the roost. That remains to this day, where you are far more likely to find people writing Web applications in PHP or Ruby than you will find them writing in C or C++. The most likely compiled language for Web development — Java — is still technically an interpreted language, albeit not usually considered a scripting language.

Nowadays, writing major components of an application using a scripting language is not terribly surprising. While this is still most common with Web applications, you can find scripting languages used in the browser (JavaScript), games (Lua), virtual worlds (LSL), and so on. Even though these languages execute more slowly than their C/C++ counterparts, they offer much greater flexibility, and faster CPUs make the performance of scripts less critical.

### Following the Script

Scripting languages are not built into Android, beyond the JavaScript interpreter in the WebKit Web browser. Despite this, there is quite a bit of interest in scripting on Android, and the biggest reasons for this come down to experience and comfort level.

### Your Expertise

Perhaps you have spent your entire career writing Python scripts, or you cut your teeth on Perl CGI programs, or you have gotten seriously into Ruby development.

Maybe you used Java in previous jobs and hate it with the fiery passion of a thousand suns.

Regardless of the cause, your expertise may lie outside the traditional Android realm of Java-based development. Perhaps you would never touch Android if you had to write in Java, or maybe you feel you would just be significantly more productive in some other language. How much that productivity gain is real versus “in your head” is immaterial — if you want to develop in some other language, you owe it to yourself to try.

### Your Users' Expertise

Maybe you are looking to create a program where not only you can write scripts, but so can your users. This might be a utility, or a game, or rulesets for email management, or whatever.

In that case, you need:

1. Something interpreted, so you can execute what the user types in
2. Something embeddable, so your larger application (typically written in Java, of course) is capable of executing those scripts
3. Something your users will be comfortable using for scripting

The last criterion is perhaps the toughest, as non-developers typically have limited experience in writing scripts in any language, let alone one that runs on Android. Perhaps the most popular such language is Basic, in the form of VBA and VBScript on Windows... but there are no interpreters for those languages for Android at this time.

### Crowd-Developing

Perhaps your users will not only be entering scripts for their own benefit, but for others' benefit as well.

Many platforms have been improved by power users and amateur developers alike. Browser users gain from those writing GreaseMonkey scripts. Bloggers benefit from those writing WordPress themes. And so on.

To facilitate this sort of work, not only do you need an interpreted, embeddable, user-familiar scripting environment, but you need some means for users to publish their scripts and download the scripts of others. Fortunately, with Android having near-continuous connectivity, your challenge will lie more on organizing and hosting the scripts, more so than getting them on and off of devices.

### Going Off-Script

Scripting languages on Android have their fair share of issues. It is safe to say that while Android does not prohibit the use of scripting languages, its architecture does not exactly go out of its way to make them easy to use, either.

### Security

For a scripting language to do much that is interesting, it is going to need some amount of privileges. A script cannot access the Internet unless its process has that right. A script cannot modify the user's contacts unless its process has that right. And so on.

For scripts you write, so long as those scripts cannot be modified readily by malware authors, security is whatever you define it to be. If your script-based application needs Internet access, so be it.

For scripts your users write, things get a bit more challenging, since permissions cannot be modified on the fly by applications. Many interpreters will tend to request (or otherwise have access to) permissions that are broader than any individual user might need, because those permissions are needed by somebody. However, the risk is still minimal to the user, so long as they are careful with the scripts they write.

For scripts your users might download, written by others, security becomes a big problem. If the interpreter has a wide range of permissions, downloaded scripts can easily host malware that exploits those permissions for nefarious ends. An interpreter with both Internet access and the right to read the user's contacts means that any script the user might download and run could copy the user's contact data and send it to spammers or identity thieves.

### Performance

Java, as interpreted by the Dalvik virtual machine, is reasonably fast, particularly on Android 2.2 and newer versions. C/C++, through the NDK, is far faster.

Scripting languages are a mixed bag.

Some scripting languages for Android have interpreters that are implemented in C code. Those interpreters' performance is partly a function of how well they were written and ported over to the chipsets Android runs on. However, if those interpreters expose Android APIs to the language, that can add considerable overhead. For example, the Scripting Layer for Android (SL4A) makes Android APIs available to scripting languages via a tiny built-in Java Web server and a Web service API. While convenient for language integration, converting simple Java calls into Web service calls slows things down quite a bit.

Some scripting languages have interpreters that themselves are written in Java and run on the virtual machine. Those are likely to perform worse on an Android device than when they are run on a desktop or server, simply because of the performance differences between the standard Java VMs and the Dalvik VM. However, they will have quicker access to the Java class libraries that make up much of Android than will C-based interpreters.

### **Cross-Platform Compatibility**

Most of the scripting languages for Android are ports from versions that run across multiple platforms. This is one of their big benefits – that is where you and your users may have gained experience with those languages. However, just as, say, Perl and Python run a bit differently on Windows than on Linux or OS X, there will be some differences in how those languages run on Android. The Android operating system is not a traditional Linux environment, and so file paths, environment variables, available pre-installed programs, and the like will not be the same. Some of those may, in turn, impact how the scripting languages operate. You may need to make some modification to any existing scripts for those languages that you attempt to run on Android.

### **Maturity... On Android**

Some scripting languages that have been ported to Android are rather old, like Perl and Python. Others are old and somewhat abandoned for traditional development, like BeanShell. Yet others are fairly new to the programming scene altogether, like JRuby.

However, none of them have a long track record on Android, simply because Android itself has not been around very long. This has several implications:

1. There is more likely to be bugs in newer ports of a language than older ports
2. Fewer people will have experience in supporting these languages on Android (compared to supporting them on Linux, for example)
3. The number of production applications built using these languages on Android is minuscule compared to their use on more traditional environments





# The Scripting Layer for Android

---

When it comes to scripting languages on Android, the first stop should always be the [Scripting Layer for Android](#) (SL4A). Led by Damon Kohler, this project is rather popular, both among hardcore Android developers and those people looking to automate a bit more of their Android experience.

## Prerequisites

Understanding this chapter requires that you have read the core chapters of this book.

## The Role of SL4A

What started as an experiment to get Python and Lua going on Android, back in late 2008, turned into a more serious endeavor in June 2009, when the Android Scripting Environment (now called the Scripting Layer for Android, or SL4A) was announced on the [Google Open Source blog](#) and the Google Code site for it was established. Since then, SL4A has been a magnet for people interested in getting their favorite language working on Android or advancing its support.

## On-Device Development

Historically, the primary role of SL4A was as a tool to allow people to put together scripts, often written on the device itself, to take care of various chores. This appealed to developers who were looking for something lightweight compared to the Android SDK and Java. For those used to tinkering with scripts on other mobile Linux platforms (e.g., the Nokia N800 running Maemo), SL4A promised a similar sort of capability.

Over time, SL4A's scope in this area has grown, including preliminary support for SL4A scripts packaged as APK files, much like an Android application written in Java or any of the alternative frameworks described in this book.

## Getting Started with SL4A

SL4A is a bit more difficult to install than is the average Android application, due to the various interpreters it uses and their respective sizes. That being said, none of the steps involved with getting SL4A set up are terribly difficult, and most are just part of the application itself.

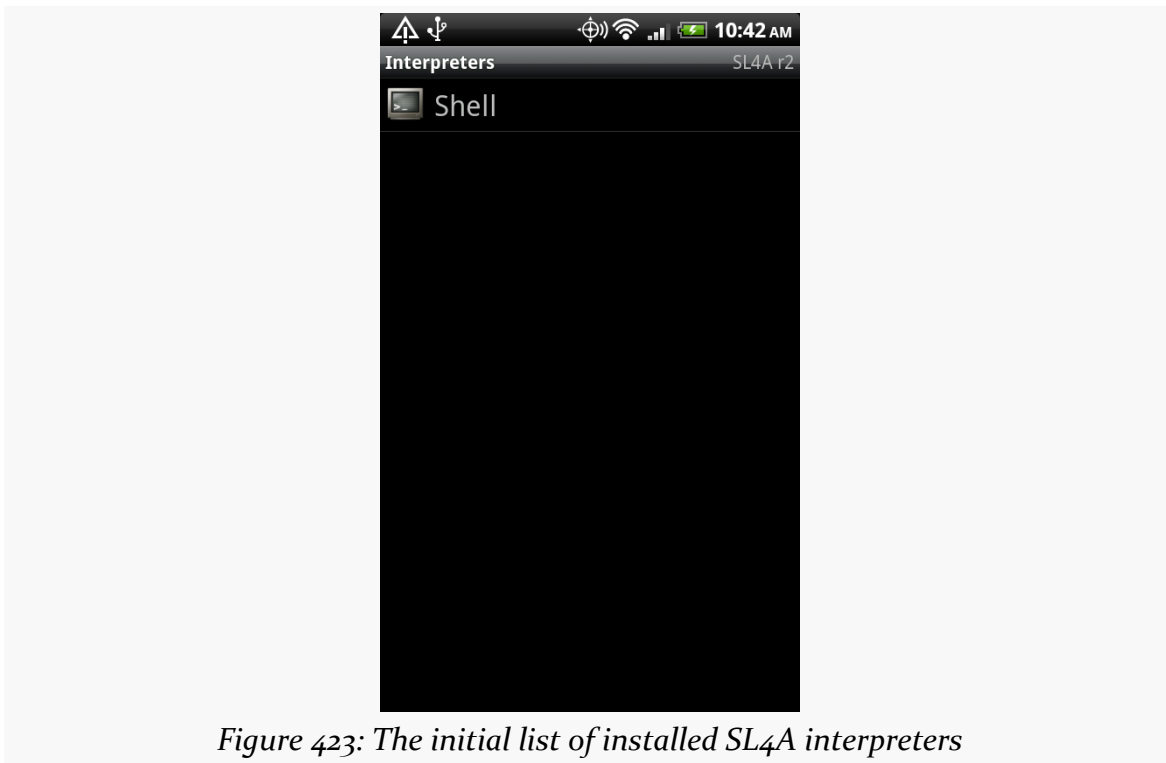
### Installing SL4A

At the time of this writing, SL4A is not distributed via the Android Market. Instead, you can download it to your device off of the [SL4A Web site](#). Perhaps the easiest way to do that is to scan the QR code on the SL4A home page using [Barcode Scanner](#) or a similar utility.

### Installing Interpreters

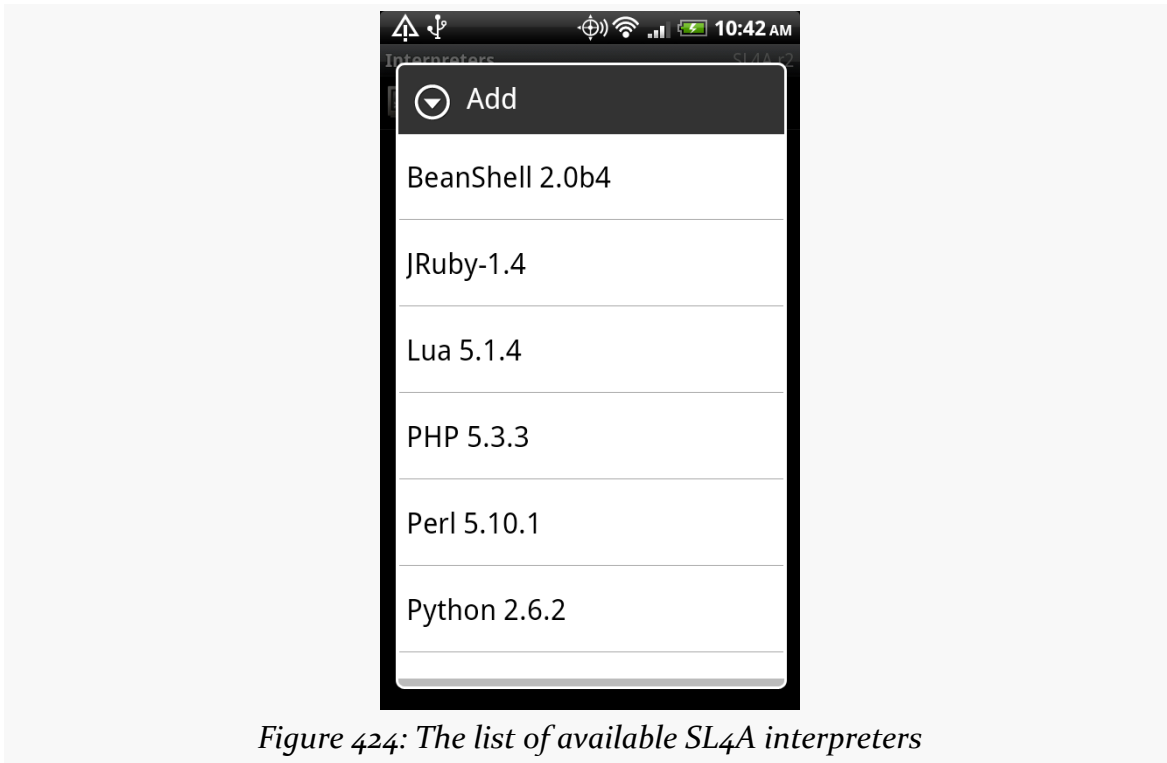
When you first install SL4A, the only available scripting language is for shell scripts, as that is built into Android itself. If you want to work with other interpreters, you will need to download those. That is why the base SL4A download is so small (~200KB) — most of the smarts are separate downloads, largely due to size.

To add interpreters, launch SL4A from the launcher, then choose View > Interpreters from the option menu. You will be presented with the (presently short) list of installed interpreters:



*Figure 423: The initial list of installed SL4A interpreters*

Then, to install additional interpreters, choose Add from the option menu. You will be given a roster of SL4A-compatible interpreters to choose from:



*Figure 424: The list of available SL4A interpreters*

Click on one of the interpreters, and this will trigger the download of an APK file for that specific interpreter. Slide down the notification drawer and click on that APK file to continue the installation process. When the APK itself is installed, open up that interpreter (e.g., click the “Open” button when the install is done). That will bring up an activity to let you download the rest of the interpreter binaries:



*Figure 425: Downloading the Python SL4A interpreter, continued*

Click the Install button, and SL4A will download and install the interpreter's component parts:



*Figure 426: Downloading the Python SL4A interpreter*

This may take one or several downloads, depending on the interpreter. When done, and after a few progress dialogs' worth of unpacking, the interpreter will appear in the list of interpreters:



*Figure 427: The updated list of installed SL4A interpreters*

Note that the interpreters will be installed on your device's "external storage" (typically some flavor of SD card), due to their size. You will find an SL4A/ directory on that card with the interpreters and scripts.

### Running Supplied Scripts

Back on the Scripts activity (e.g., what you see when you launch SL4A from the launcher), you will be presented with a list of the available scripts. Initially, these will be ones that shipped with the interpreters, as examples for how to write SL4A scripts in that language:



## THE SCRIPTING LAYER FOR ANDROID

---

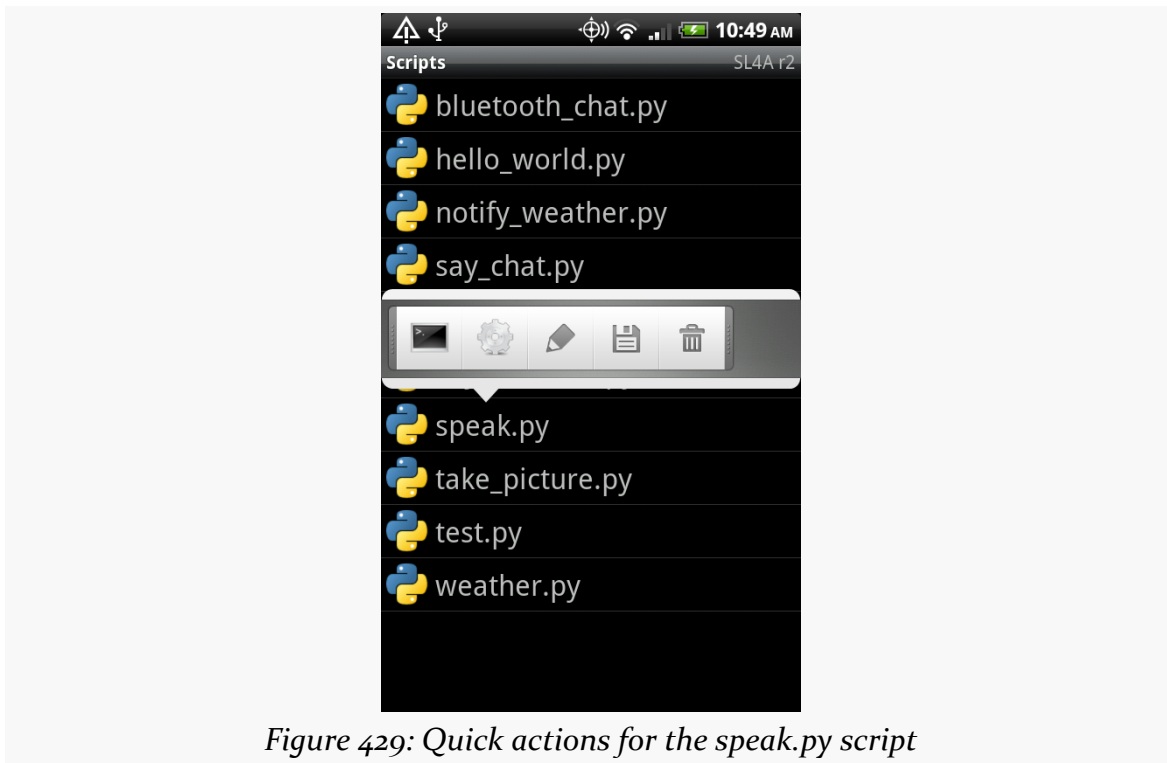


*Figure 428: The list of SL4A scripts*

Tapping on any of these scripts will bring up a “quick actions” balloon:

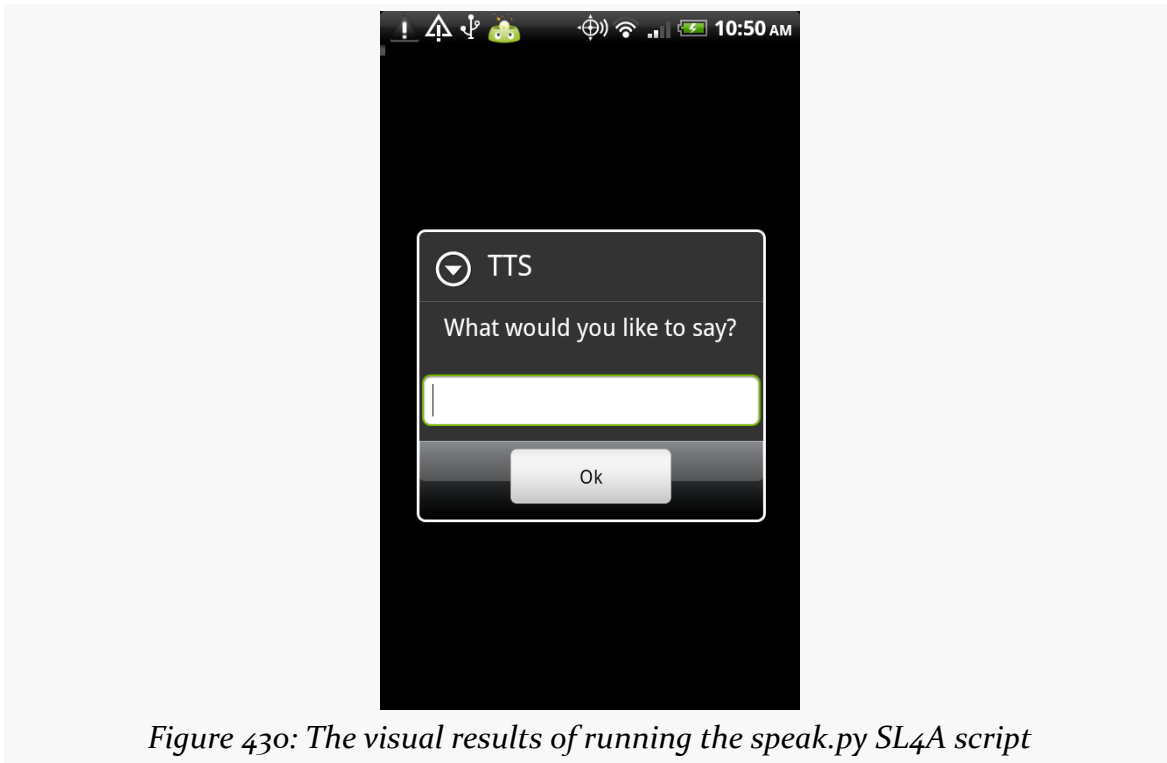
## THE SCRIPTING LAYER FOR ANDROID

---



*Figure 429: Quick actions for the speak.py script*

Click the little shell icon to run it, showing its terminal output along the way:



*Figure 430: The visual results of running the `speak.py` SL4A script*

## Writing SL4A Scripts

While the scripts supplied with the interpreters are... entertaining, they only scratch the surface of what an SL4A script can accomplish. Of course, to go beyond what is there, you will need to start writing some scripts.

### Editing Options

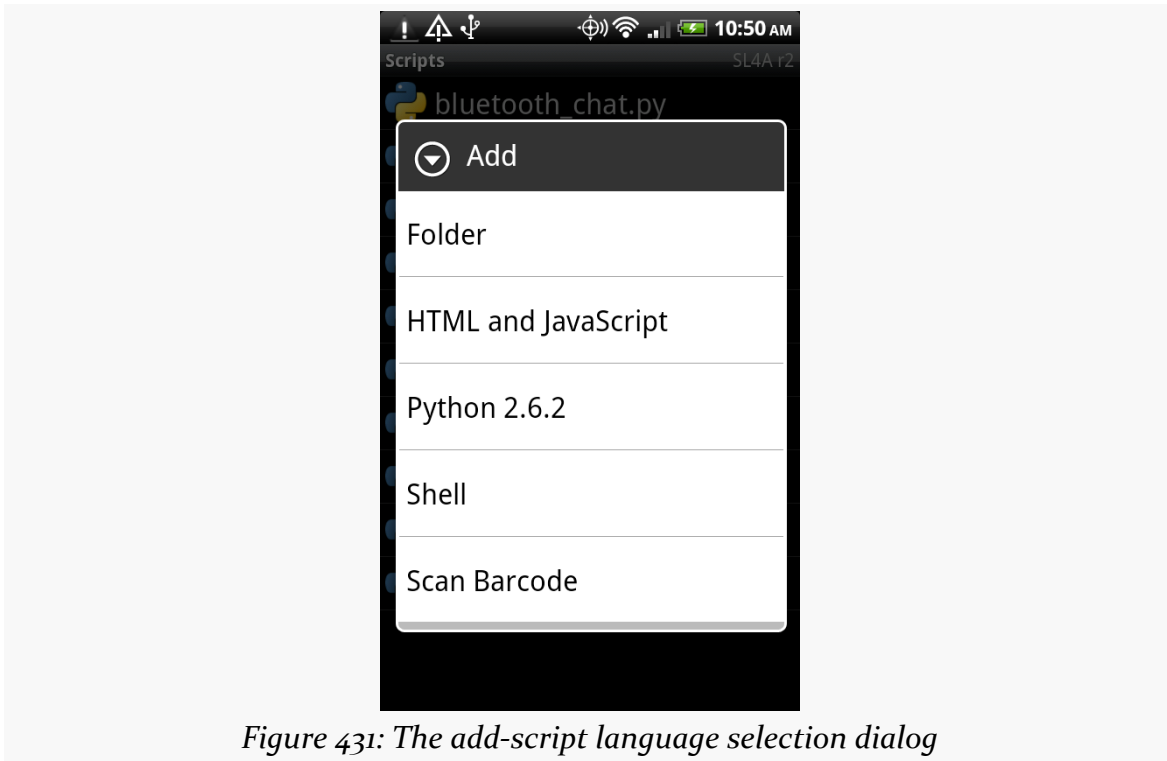
Since scripts are stored on your SD card (or whatever the “external storage” is for your device), you can create scripts using some other computer — one with fancy things like “mice” and “ergonomic keyboards” — and transfer it over via USB, like you would transfer over an MP3 file. This eases typing, but it will make for an awkward development cycle, since your computer and the Android device cannot both have access to the SD card simultaneously. The mount/unmount process may get a bit annoying. On the other hand, this is a great way to transfer over a script you obtained from somebody else.

## THE SCRIPTING LAYER FOR ANDROID

---

Another option is to edit your scripts on the device. SL4A has a built in script editor designed for this purpose. Of course, the screen may be a bit small and the keyboard may be a bit... soft, but this is a great answer for small scripts.

To add a new script, from the Scripts activity, choose Add from the option menu. This will bring up a roster of available scripting languages and other items (e.g., add a folder):



*Figure 431: The add-script language selection dialog*

(the “Scan Barcode” option gives you an easy route to install a third-party script, one encoded in a QR code)

Tap the language you want, and you will be taken into the script editor:



*Figure 432: The script editor*

The field at the top is for the script name, and the large text area at the bottom is for the script itself. A file extension and boilerplate code will be supplied for you automatically.

In fact, that boilerplate code is rather important, as you will see momentarily.

To edit an existing script, long-tap on the script in the list and choose Edit from the context menu.

To save your changes to a new or existing script, choose the Save option from the script editor option menu. You can also “Save and Run” to test the script immediately.

### Calling Into Android

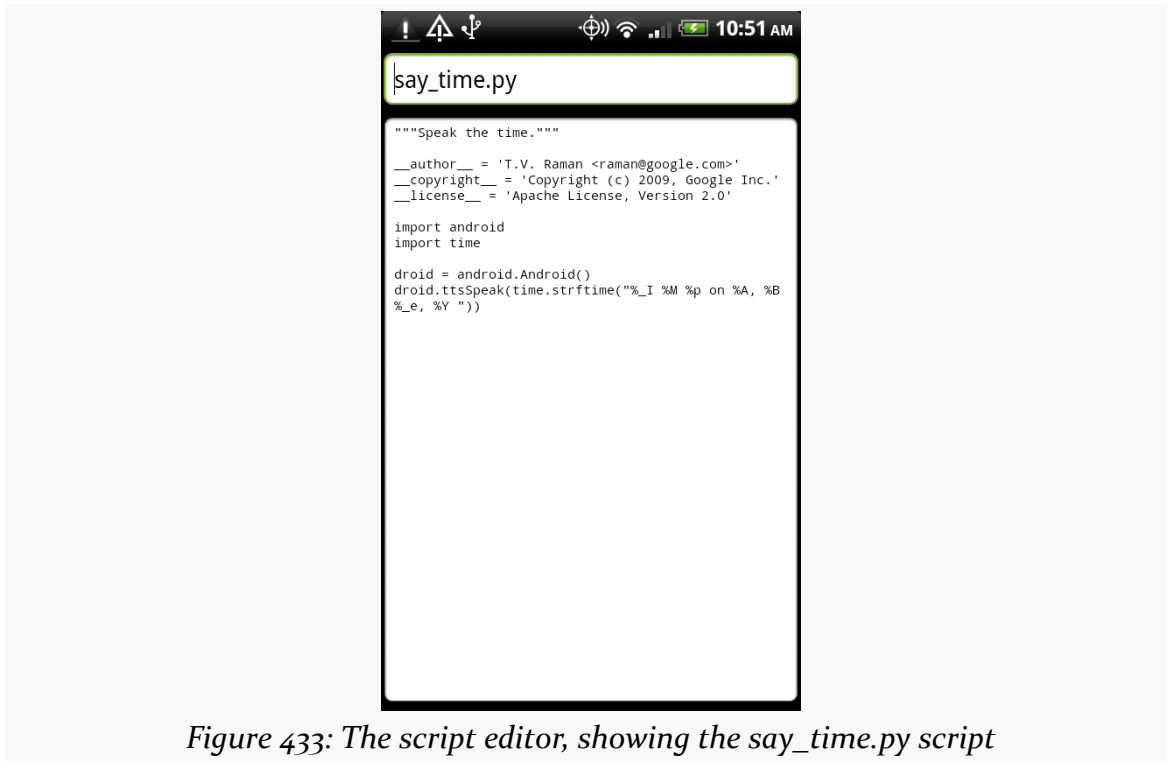
In the real world, Perl knows nothing about Android. Neither does Python, BeanShell, or most of the other scripting languages available for SL4A. This would be rather limiting, as most of what you would want a script to do will have to deal with the device to some level: collect input, get a location, say some text using speech synthesis, dial the phone, etc.

## THE SCRIPTING LAYER FOR ANDROID

---

Fortunately, SL4A has a solution, one of those “so crazy, it just might work” sorts of solutions: SL4A has a built-in RPC server. While implementing a server on a smartphone is not something one ordinarily does, it provides an ingenious bridge from the scripting language to the device itself.

Each scripting language is given a local object proxy that works with the RPC server. For example, here is a Python script that speaks the current time:



*Figure 433: The script editor, showing the say\_time.py script*

The `import android` and `droid=android.Android()` statements establish a connection between the Python interpreter and the SL4A RPC server. From that point, the `droid` object is available for use to access Android capabilities — in this case, speaking a message.

Python does not strictly realize that it is accessing local functionality. It simply makes RPC calls, ones that just so happen to be fulfilled on the device rather than via some remote RPC server accessed over the Internet.

### Browsing the API

Therefore, SL4A effectively exposes an API to each of its scripting languages, via this RPC bridge. While the API is not huge, it accomplishes a lot and is ever-growing.

If you are editing scripts on the device, you can browse the API by choosing the API Browser option menu from the script editor. This brings up a list of available methods on your RPC proxy (e.g., droid) that you can call:



*Figure 434: The script editor's API browser*

Tapping on any item in the list will “unfold” it to provide more details, such as the parameter list. Long-tapping on an item brings up a context menu where you can:

1. insert a template call to the method into your script at the cursor position
2. “prompt” you for the parameter values for the method, then insert the completed method call into your script

It is also possible to [browse the API](#) in a regular Web browser, if you are developing scripts off-device.

## Running SL4A Scripts

Scripts are only useful if you run them, of course. We have seen two options for running scripts: tapping on them in the scripts list, or choosing “Save & Run” from the script editor. Those are not your only options, however.

### Background

If you long-tap on a script in the script list, you will see a context menu option to “Start in Background”. As the name suggests, this kicks off the script in the background. Rather than seeing the terminal window for the script, the script just runs. A notification will appear in the status bar, with the SL4A icon, indicating that the RPC server is in operation and that script(s) may be running.

### Shortcuts

Rather than have to open up SL4A every time, you can set up shortcuts on your home screen to run individual scripts. Just long-tap on the home screen background and choose Shortcuts from the context menu, then Scripts from the available shortcuts. This brings up the scripts list, but this time, when you choose a script, you are presented with a quick actions balloon for how to start it: in a terminal or in the background:





*Figure 435: Configuring an SL4A shortcut*

Choose one, and at this point, a shortcut, with the interpreter's icon and the name of the script, will appear on your home screen. Tapping it runs the script.

### Other Alternatives

Users of Locale — an application designed to trigger events at certain times or when you get to certain locations — can trigger SL4A scripts in addition to invoking standard built-in tools.

In addition, there is [preliminary support](#) in SL4A for packaging scripts as APK files for wider distribution.

### Potential Issues

As the SL4A Web site indicates, SL4A is “alpha-quality”. It is not without warts. How much those warts are an issue for you, in terms of crafting and running utility scripts, is up to you.

### Security... From Scripts

SL4A itself holds a long list of Android permissions, including:

1. The ability to read your contact data
2. The ability to call phone numbers and place SMS messages
3. Access to your location
4. Access to your received SMS/MMS messages
5. Bluetooth access
6. Internet access
7. The ability to write to the SD card
8. The ability to record audio and take pictures
9. The ability to keep your device awake
10. The ability to retrieve the list of running applications and restart other applications
11. And so on

Hence, its scripts — via the RPC-based API — can perform all of those actions. For example, a script you download from a third party could read all your contacts and send that information to a spammer. Hence, you should only run scripts that you trust, since SL4A effectively “wires open” many aspects of Android’s standard security protections.

### Security... From Other Apps

Originally, the on-device Web service supplying the RPC-based API was wide open. Any program that could find the port could connect to that Web service and invoke operations. That would not necessarily be all that bad... except that the Web service runs in its own process with its own permissions, and it may have permissions that other applications lack (e.g., right to access the Internet or to read contacts). Given that, malware could use SL4A to do things that it, by itself, could not do, allowing it to sneak onto more devices.

SL4A now uses a token-based authentication mechanism for using the Web service, to help close this loophole. In principle, only SL4A scripts should be able to use the RPC server.



# JVM Scripting Languages

---

The Java virtual machine (JVM) is a remarkably flexible engine. While it was originally developed purely for Java, it has spawned its own family of languages, just as Microsoft's CIL supports multiple languages for the Windows platform. Some languages targeting the JVM as a runtime will work on Android, since the regular Java VM and Android's Dalvik VM are so similar.

## Prerequisites

Understanding this chapter requires that you have read the core chapters of this book. Some of the sample code demonstrates JUnit test cases, so reading [the chapter on unit testing](#) may be useful.

## Languages on Languages

Except for the handful of early language interpreters and compilers hand-constructed in machine code, every programming language is built atop earlier ones. C and C++ are built atop assembly language. Many other languages, such as Java itself, are built atop C/C++.

Hence, it should not come as much of a surprise that an environment as popular as Java has spawned another generation of languages whose implementations are in Java.

There are a few flavors of these languages. Some, like Scala and Clojure, are compiled languages whose compilers created JVM bytecodes, no different than would a Java compiler. These do not strictly qualify as a “scripting language”, however, since they typically compile their source code to bytecode ahead of time.

Some Java-based scripting languages use fairly simple interpreters. These interpreters convert scripting code into parsed representations (frequently so-called “abstract syntax trees”, or ASTs), then execute the scripts from their parsed forms. Most scripting languages at least start here, and some, like BeanShell, stick with this implementation.

Other scripting languages try to bridge the gap between a purely interpreted language and a compiled one like Scala or Clojure. These languages turn the parsed scripting code into JVM bytecode, effectively implementing their own just-in-time compiler (JIT). Since many Java runtimes themselves have a JIT to turn bytecode into machine code (“opcode”), languages with their own JIT can significantly outperform their purely-interpreted counterparts. JRuby and Rhino are two languages that have taken this approach.

## A Brief History of JVM Scripting

Back in the beginning, the only way to write for the JVM was in Java itself. However, since writing language interpreters is a common pastime, it did not take long for people to start implementing interpreters in Java. These had their niche audiences, but there was only modest interest in the early days — interpreters made Java applets too large to download, for example.

Things got a bit more interesting in 1999, when IBM [released](#) the Bean Scripting Framework (BSF). This offered a uniform API for scripting engines, meaning that a hosting Java application could write to the BSF API, then plug in arbitrary interpreters at runtime. It was even possible, with a bit of extra work, to allow new interpreters to be downloaded and used on demand, rather than having to be pre-installed with the application. BSF also standardized how to inject Java objects into the scripting engines themselves, for access by the scripts. This allowed scripts to work with the host application’s objects, such as allowing scripts to manipulate the contents of the [jEdit](#) text editor.

This spurred interest in scripting. In addition to some IBM languages (e.g., [NetREXX](#)) supporting BSF natively, other languages, like [BeanShell](#), created BSF adapters to allow their languages to participate in the BSF space. On the consumer side, various Web frameworks started supporting BSF scripting for dynamic Web content generation, and so forth.

Interest was high enough that Apache took over stewardship of [BSF](#) in 2003. Shortly thereafter, Sun and others started work on [JSR-223](#), which added the `javax.script`

framework to Java 6. The `javax.script` framework advanced the BSF concept and standardized it as part of Java itself.

At this point, most JVM scripting languages that are currently maintained support `javax.script` integration, and may also support integration with the older BSF API as well.

Android does not include `javax.script` as part of its subset of the Java SE class library from the Apache Harmony project. This certainly does not preclude integrating scripting languages into Android applications, but it does raise the degree of difficulty a bit.

## Limitations

Of course, JVM scripting languages do not necessarily work on Android without issue. There may be some work to get a JVM language going on Android, above and beyond the [challenges for scripting languages](#) in general on Android.

## Android SDK Limits

Android is not Java SE, or Java ME, or even Java EE. While Android has many standard Java classes, it does not have a class library that matches any traditional pattern. As such, languages built assuming Java SE, for example, may have some dependency issues.

For languages where you have access to the source code, removing these dependencies may be relatively straightforward, particularly if they are ancillary to the operation of the language itself. For example, the language may come with miniature Swing IDEs, support for scripted servlets, or other capabilities that are not particularly relevant on Android and can be excised from the source code.

## Wrong Bytecode

Android runs Dalvik bytecode, not Java bytecode. The conversion from Java bytecode to Dalvik bytecode happens at compile time. However, the conversion tool is rather finicky — it wants bytecode from Sun/Oracle's Java 1.5 or 1.6, nothing else. This can cause some problems:

1. You may encounter a JAR that is old enough to have been compiled with Java 1.4.2

2. You may encounter JARs compiled using other compilers, such as the GNU Compiler for Java (GCJ), common on Linux distributions
3. Eventually, when Java 7 ships, there may be bytecode differences that preclude Java 7-compiled JARs from working with Android
4. Languages that have their own JIT compilers will have problems, because their JIT compilers will be generating Java bytecodes, not Dalvik bytecodes, meaning that the JIT facility needs to be rewritten or disabled

Again, if you have the source code, recompiling on an Android-friendly Java compiler should be a simple process.

### Age

The heyday of some JVM languages is in the past. As such, you may find that support for some languages will be limited, simply because few people are still interested in them. Finding people interested in those languages on Android — the cross-section of two niches — may be even more of a problem.

## SL4A and JVM Languages

SL4A supports three JVM languages today:

1. BeanShell
2. JRuby
3. Rhino (JavaScript)

You can use those within your SL4A environment no different than you can any other scripting language (e.g., Perl, Python, PHP). Hence, if what you are looking for is to create your own personal scripts, or writing small applications, SL4A saves you a lot of hassle. If there is a JVM scripting language you like but is not supported by SL4A, adding support for new interpreters within SL4A is fairly straightforward, though the APIs may change as SL4A is undergoing a fairly frequent set of revisions.

## Embedding JVM Languages

While SL4A will drive end users towards writing their own scripts or miniature applications using JVM languages, another use of these languages is for embedding in a full Android application. Scripting may accelerate development, if the developers are more comfortable with the scripted language than with Java. Also, if

the scripts are able to be modified or expanded by users, an ecosystem may emerge for user-contributed scripts.

### Architecture for Embedding

Embedding a scripting language is not something to be undertaken lightly, even on a desktop or server application. Mobile devices running Android will have similar issues.

#### Asynchronous

One potential problem is that a script may take too long to execute. Android's architecture assume that work triggered by buttons, menus, and the like will either happen very quickly or will be done on background threads. Particularly for user-generated scripts, the script execution time is unknowable in advance — it might be a few milliseconds, or it might be several seconds. Hence, any implementation of a scripting extension for an Android application needs to consider executing all scripts in a background thread. This, of course, raises its own challenges for reflecting those scripts' results on-screen, since GUI updates cannot be done on a background thread.

#### Security

Scripts in Android inherit the security restrictions of the process that runs the script. If an application has the right to access the Internet, so will any scripts run in that application's process. If an application has the right to read the user's contacts, so will any scripts run in that application's process. And so on. If the scripts in question are created by the application's authors, this is not a big deal — the rest of the application has those same permissions, after all. But, if the application supports user-authored scripts, it raises the potential of malware hijacking the application to do things that the malware itself would otherwise lack the rights to do.

#### Inside the InterpreterService

One way to solve both of those problems is to isolate the scripting language in a self-contained low-permission APK — “sandboxing” the interpreter so the scripts it executes are less able to cause harm. This APK could also arrange to have the interpreter execute its scripts on a background thread. An even better implementation would allow the embedding application to decide whether or not



the “sandbox” is important — applications with a controlled source of scripts may not need the extra security or the implementation headaches it causes.

With that in mind, let us take a look at the [JVM/InterpreterService](#) sample project, one possible implementation of the strategy described above.

### The Interpreter Interface

The InterpreterService can support an arbitrary number of interpreters, via a common interface. This interface provides a simplified API for having an interpreter execute a script and return a result:

```
package com.commonware.abj.interp;

import android.os.Bundle;

public interface I_Interpreter {
    Bundle executeScript(Bundle input);
}
```

As you can see, it is *very* simplified, offering just a single `executeScript()` method. That method accepts a `Bundle` (a key-value store akin to a Java `HashMap`) as a parameter — that `Bundle` will need to contain the script and any other objects needed to execute the script.

The interpreter will return another `Bundle` from `executeScript()`, containing whatever data it wants the script’s requester to have access to.

For example, here is the implementation of `EchoInterpreter`, which just returns the same `Bundle` that was passed in:

```
package com.commonware.abj.interp;

import android.os.Bundle;

public class EchoInterpreter implements I_Interpreter {
    public Bundle executeScript(Bundle input) {
        return(input);
    }
}
```

A somewhat more elaborate sample is the `SQLiteInterpreter`:

```
package com.commonware.abj.interp;

import android.database.Cursor;
```

## JVM SCRIPTING LANGUAGES

---

```
import android.database.sqlite.SQLiteDatabase;
import android.os.Bundle;

public class SQLiteInterpreter implements I_Interpreter {
    public Bundle executeScript(Bundle input) {
        Bundle result=new Bundle(input);
        String script=input.getString(InterpreterService.SCRIPT);

        if (script!=null) {
            SQLiteDatabase db=SQLiteDatabase.create(null);
            Cursor c=db.rawQuery(script, null);

            c.moveToFirst();

            for (int i=0;i<c.getColumnCount();i++) {
                result.putString(c.getColumnName(i), c.getString(i));
            }

            c.close();
            db.close();
        }

        return(result);
    }
}
```

This class accepts a script, in the form of a SQLite database query. It extracts the script from the Bundle, using a pre-defined key (InterpreterService.SCRIPT). Assuming there is such a script, it creates an empty in-memory database and executes the SQLite query against that database.

The results come back in the form of a Cursor — itself a key-value store. SQLiteInterpreter takes those results and pours them into a Bundle to be returned.

The Bundle being returned starts from a copy of the input Bundle, so the script requester can embed in the input Bundle any identifiers it needs to determine how to handle the results from executing this script.

SQLiteInterpreter is not terribly flexible, but you can use it for simple numeric and string calculations, such as the following script:

```
SELECT 1+2 AS result, 'foo' AS other_result, 3*8 AS third_result;
```

This would return a Bundle containing a key of result with a value of 3, a key of other\_result with a value of foo, and a key of third\_result with a value of 24.

Of course, it would be nice to support more compelling interpreters, and we will examine a pair of those later in this chapter.

### Loading Interpreters and Executing Scripts

Of course, having a nice clean interface to the interpreters does nothing in terms of actually executing them on a background thread, let alone sandboxing them. The `InterpreterService` class itself handles that.

`InterpreterService` is an `IntentService`, which automatically routes incoming `Intent` objects (from calls to `startService()`) to a background thread via a call to `onHandleIntent()`. `IntentService` will queue up `Intent` objects if needed, and `IntentService` even automatically shuts down if there is no more work to be done.

Here is the implementation of `onHandleIntent()` from `InterpreterService`:

```
@Override
protected void onHandleIntent(Intent intent) {
    String action=intent.getAction();
    I_Interpreter interpreter=interpreters.get(action);

    if (interpreter==null) {
        try {
            interpreter=(I_Interpreter)Class.forName(action).newInstance();
            interpreters.put(action, interpreter);
        }
        catch (Throwable t) {
            Log.e("InterpreterService", "Error creating interpreter", t);
        }
    }

    if (interpreter==null) {
        failure(intent, "Could not create interpreter: "+intent.getAction());
    }
    else {
        try {
            success(intent,
interpreter.executeScript(intent.getBundleExtra(BUNDLE)));
        }
        catch (Throwable t) {
            Log.e("InterpreterService", "Error executing script", t);

            try {
                failure(intent, t);
            }
            catch (Throwable t2) {
                Log.e("InterpreterService",
                    "Error returning exception to client",
                    t2);
            }
        }
    }
}
```

```
}  
  }  
}  }
```

We keep a cache of interpreters, since initializing their engines may take some time. That cache is keyed by the interpreter’s class name, and that key comes in to the service by way of the action on the Intent that was used to start the service. In other words, the script requester tells us, by way of the Intent used in `startService()`, which interpreter to use.

Those interpreters are created using reflection. This way, `InterpreterService` has no compile-time knowledge of any given interpreter class. Interpreters can come and go, but `InterpreterService` remains the same.

Assuming an interpreter was found (either cached or newly created), we have it execute the script, with the input `Bundle` coming from an “extra” on the Intent. Methods named `success()` and `failure()` are then responsible for getting the results to the script requester... as will be seen in the next section.

### Delivering Results

Script requesters can get the results of the script back — in the form of the interpreter’s output `Bundle` — in one of two ways.

One option is a private broadcast Intent. This is a broadcast Intent where the broadcast is limited to be delivered only to a specific package, not to any potential broadcast receiver on the device.

The other option is to supply a `PendingIntent` that will be sent with the results. This could be used by an `Activity` and `createPendingIntent()` to have control routed to its `onActivityResult()` method. Or, an arbitrary `PendingIntent` could be created, to start another activity, for example.

The implementations of `success()` and `failure()` in `InterpreterService` simply build up an Intent containing the results to be delivered:

```
private void success(Intent intent, Bundle result) {  
    Intent data=new Intent();  
  
    data.putExtras(result);  
    data.putExtra(RESULT_CODE, SUCCESS);  
}
```

## JVM SCRIPTING LANGUAGES

---

```
    send(intent, data);
}

private void failure(Intent intent, String message) {
    Intent data=new Intent();

    data.putExtra(ERROR, message);
    data.putExtra(RESULT_CODE, FAILURE);

    send(intent, data);
}

private void failure(Intent intent, Throwable t) {
    Intent data=new Intent();

    data.putExtra(ERROR, t.getMessage());
    data.putExtra	TRACE, getStackTrace(t));
    data.putExtra(RESULT_CODE, FAILURE);

    send(intent, data);
}
```

These, in turn, delegate the actual sending logic to a `send()` method that delivers the result Intent via a private broadcast or a `PendingIntent`, as indicated by the script requester:

```
private void send(Intent intent, Intent data) {
    String broadcast=intent.getStringExtra(BROADCAST_ACTION);

    if (broadcast==null) {
        PendingIntent pi=(PendingIntent)intent.getParcelableExtra(PENDING_RESULT);

        if (pi!=null) {
            try {
                pi.send(this, Activity.RESULT_OK, data);
            }
            catch (PendingIntent.CanceledException e) {
                // no-op -- client must be gone
            }
        }
    }
    else {
        data.setPackage(intent.getStringExtra(BROADCAST_PACKAGE));
        data.setAction(broadcast);

        sendBroadcast(data);
    }
}
```

### Packaging the InterpreterService

There are three steps for integrating InterpreterService into an application.

First, you need to decide what APK the InterpreterService goes in – the main one for the application (no sandbox) or a separate low-permission one (sandbox).

Second, you need to decide what interpreters you wish to support, writing I\_Interpreter implementations and getting the interpreters' JARs into the project's libs/ directory.

Third, you need to add the source code for InterpreterService along with a suitable <service> entry in AndroidManifest.xml. This entry will need to support <intent-filter> elements for each scripting language you are supporting, such as:

```
<service
  android:name=".InterpreterService"
  android:exported="false">
  <intent-filter>
    <action android:name="com.commonware.abj.interp.EchoInterpreter"/>
  </intent-filter>
  <intent-filter>
    <action android:name="com.commonware.abj.interp.SQLiteInterpreter"/>
  </intent-filter>
  <intent-filter>
    <action android:name="com.commonware.abj.interp.BshInterpreter"/>
  </intent-filter>
  <intent-filter>
    <action android:name="com.commonware.abj.interp.RhinoInterpreter"/>
  </intent-filter>
</service>
```

From there, it is a matter of adding in appropriate startService() calls to your application wherever you want to execute a script, and processing the results you get back.

### Using the InterpreterService

To use the InterpreterService, you need to first determine which I\_Interpreter engine you are using, as that forms the action for the Intent to be used with the InterpreterService. Create an Intent with that action, then add in an InterpreterService.BUNDLE extra for the script and other data to be supplied to the interpreter. Also, you can add an InterpreterService.BROADCAST\_ACTION, to be used by InterpreterService to send results back to you via a broadcast Intent.

Finally, call `startService()` on the Intent, and the results will be delivered to you asynchronously.

For example, here is a test method from the `EchoInterpreterTests` test case:

```
package com.commonware.abj.interp;

import android.os.Bundle;

public class EchoInterpreterTests extends InterpreterTestCase {
    protected String getInterpreterName() {
        return("com.commonware.abj.interp.EchoInterpreter");
    }

    public void testNoInput() {
        Bundle results=execServiceTest(new Bundle());

        assertNotNull(results);
        assertEquals(results.size(), 0);
    }

    public void testWithSomeInputJustForGrins() {
        Bundle input=new Bundle();

        input.putString("this", "is a value");

        Bundle results=execServiceTest(input);

        assertNotNull(results);
        assertEquals(results.getString("this"), "is a value");
    }
}
```

The echo “interpreter” simply echoes the input Bundle into the output. The `execServiceTest()` method is inherited from the `InterpreterTestCase` base class:

```
protected Bundle execServiceTest(Bundle input) {
    Intent i=new Intent(getInterpreterName());

    i.putExtra(InterpreterService.BUNDLE, input);
    i.putExtra(InterpreterService.BROADCAST_ACTION, ACTION);

    getContext().startService(i);

    try {
        latch.await(5000, TimeUnit.MILLISECONDS);
    }
    catch (InterruptedException e) {
        // just keep rollin'
    }
}
```

```
return(results);  
}
```

The `execServiceTest()` method uses a `CountDownLatch` to wait on the interpreter to do its work before proceeding (or 5000 milliseconds, whichever comes first). The broadcast Intent containing the results, registered to watch for `com.commonware.abj.interp.InterpreterTestCase` broadcasts, stuffs the output Bundle in a results data member and drops the latch, allowing the main test thread to continue.

### BeanShell on Android

What if Java itself were a scripting language? What if you could just execute a snippet of Java code, outside of any class or method? What if you could still import classes, call static methods on classes, create new objects, as well?

That was what BeanShell offered, back in its heyday. And, since BeanShell does not use sophisticated tricks with its interpreter – like JIT compilation of scripting code — BeanShell is fairly easy to integrate into Android.

### What is BeanShell?

[BeanShell](#) is Java on Java.

With BeanShell, you can write scripts in loose Java syntax. Here, “loose” means:

1. In addition to writing classes, you can execute Java statements outside of classes, in a classic imperative or scripting style
2. Data types are optional for variables
3. Not every language feature is supported, particularly things like annotations that did not arrive until Java 1.5
4. Etc.

BeanShell was originally developed in the late 1990’s by Pat Niemeyer. It enjoyed a fair amount of success, even being considered as a standard interpreter to ship with Java ([JSR-274](#)). However, shortly thereafter, BeanShell lost momentum, and it is no longer being actively maintained. That being said, it works quite nicely on Android... once a few minor packaging issues are taken care of.



### Getting BeanShell Working on Android

BeanShell has two main problems when it comes to Android:

- The publicly-downloadable JAR was compiled for Java 1.4.2, and Android requires Java 5 or newer
- The source code includes various things, like a Swing-based GUI and a servlet, that have no real place in an Android app and require classes that Android lacks

Fortunately, with BeanShell being open source, it is easy enough to overcome these challenges. You could download the source into an Android library project, then remove the classes that are not necessary (e.g., the servlet), and use that library project in your main application. Or, you could use an Android project for creating a JAR file that was compiled against the Android class library, so you are certain everything is supported.

However, the easiest answer is to use SL4A's BeanShell JAR, since they have solved those problems already. The JAR can be found in the [SL4A source code repository](#), though you will probably need to check out the project using Mercurial, since JARs cannot readily be downloaded from the Google Code Web site.

### Integrating BeanShell

The BeanShell engine is found in the `bsh.Interpreter` class. Wrapping one of these in an `I_Interpreter` interface, for use with `InterpreterService`, is fairly simple:

```
package com.commonware.abj.interp;

import android.os.Bundle;
import bsh.Interpreter;

public class BshInterpreter implements I_Interpreter {
    public Bundle executeScript(Bundle input) {
        Interpreter i=new Interpreter();
        Bundle output=new Bundle(input);
        String script=input.getString(InterpreterService.SCRIPT);

        if (script != null) {
            try {
                i.set(InterpreterService.BUNDLE, input);
                i.set(InterpreterService.RESULT, output);

                Object eval_result=i.eval(script);
```

```
        output.putString("result", eval_result.toString());
    }
    catch (Throwable t) {
        output.putString("error", t.getMessage());
    }
}

return(output);
}
```

BeanShell interpreters are fairly inexpensive objects, so we create a fresh Interpreter for each script, so one script cannot somehow access results from prior scripts. After setting up the output Bundle and extracting the script from the input Bundle, we inject both Bundle objects into BeanShell itself, where they can be accessed like global variables, named `_bundle` and `_result`.

At this point, we evaluate the script, using the `eval()` method on the Interpreter object. If all goes well, we convert the object returned by the script into a String and tuck it into the output Bundle, alongside anything else the script may have put into the Bundle. If there is a problem, such as a syntax error in the script, we put the error message into the output Bundle.

So long as the InterpreterService has an `<intent-filter>` for the `com.commonware.abj.interp.BshInterpreter` action, and so long as we have a BeanShell JAR in the project's `libs/` directory, InterpreterService is now capable of executing BeanShell scripts as needed.

With our inherited `execServiceTest()` method handling invoking the InterpreterService and waiting for responses, we can “simply” put our script as the `InterpreterService.SCRIPT` value in the input Bundle, and see what we get out. The first test script returns a simple value; the second test script directly calls methods on the output Bundle to return its results.

### Rhino on Android

JavaScript arrived on the language scene hot on the heels of Java itself. The name was chosen for marketing purposes more so than for any technical reason. Java and JavaScript had little to do with one another, other than both adding interactivity to Web browsers. And while Java has largely faded from mainstream browser usage, JavaScript has become more and more of a force on the browser, and even now on Web servers.

And, along the way, the Mozilla project put JavaScript on Java and gave us Rhino.

### What is Rhino?

If BeanShell is Java in Java, [Rhino](#) is JavaScript in Java.

As part of Netscape's failed "Javagator" attempt to create a Web browser in Java, they created a JavaScript interpreter for Java, code-named Rhino after the cover of O'Reilly Media's [JavaScript: The Definitive Guide](#). Eventually, Rhino was made available to the Mozilla Foundation, which has continued maintaining it. At the present time, Rhino implements JavaScript 1.7, so it does not support the latest and greatest JavaScript capabilities, but it is still fairly full-featured.

Interest in Rhino has ticked upwards, courtesy of interest in using JavaScript in places other than Web browsers, such as server-side frameworks. And, of course, it works nicely with Android.

### Getting Rhino Working on Android

Similar to BeanShell, Rhino has a few minor source-level incompatibilities with Android. However, these can be readily pruned out, leaving you with a still-functional JavaScript interpreter. However, once again, it is easiest to use [SL4A's Rhino JAR](#), since all that work is done for you.

### Integrating Rhino

Putting an I\_Interpreter facade on Rhino is incrementally more difficult than it is for BeanShell, but not by that much:

```
package com.commonsware.abj.interp;

import android.os.Bundle;
import org.mozilla.javascript.*;

public class RhinoInterpreter implements I_Interpreter {
    public Bundle executeScript(Bundle input) {
        String script=input.getString(InterpreterService.SCRIPT);
        Bundle output=new Bundle(input);

        if (script != null) {
            Context ctxt=Context.enter();

            try {
                ctxt.setOptimizationLevel(-1);
```

## JVM SCRIPTING LANGUAGES

---

```
Scriptable scope=ctxt.initStandardObjects();
Object jsBundle=Context.javaToJS(input, scope);
ScriptableObject.putProperty(scope, InterpreterService.BUNDLE,
                             jsBundle);

jsBundle=Context.javaToJS(output, scope);
ScriptableObject.putProperty(scope, InterpreterService.RESULT,
                             jsBundle);

String result=
    Context.toString(ctxt.evaluateString(scope, script,
                                         "<script>", 1, null));

    output.putString("result", result);
}
finally {
    Context.exit();
}
}

return(output);
}
```

As with BshInterpreter, RhinoInterpreter sets up the output Bundle and extracts the script from the input Bundle. Assuming there is a script, RhinoInterpreter then sets up a Rhino Context object, which is roughly analogous to the BeanShell Interpreter object. One key difference is that you need to clean up the Context, by calling a static `exit()` method on the Context class, whereas with a BeanShell Interpreter, you just let garbage collection deal with it.

Rhino has a JIT compiler, one that unfortunately will not work with Android, since it generates Java bytecode, not Dalvik bytecode. However, Rhino lets you turn that off, by calling `setOptimizationLevel()` on the Context object with a value of `-1` (meaning, in effect, disable all optimizations).

After that, we:

1. Create a language scope for our script and inject standard JavaScript global objects into that scope
2. Wrap our two Bundle objects with JavaScript proxies via calls to `javaToJS()`, then injecting those objects into the scope as

`_bundle` and `_result` via `putProperty()` calls

1. Execute the script via a call to `evaluateString()` on the Context object, converting the resulting object into a String and pouring it into the output Bundle

If our `InterpreterService` has an `<intent-filter>` for the `com.commonware.abj.interp.RhinoInterpreter` action, and so long as we have a Rhino JAR in the project's `libs/` directory, `InterpreterService` can now invoke JavaScript.

## Other JVM Scripting Languages

As mentioned previously, there are many languages that, themselves, are implemented in Java and can be ported to Android, with varying degrees of difficulty. Many of these languages are fairly esoteric. Some, like JRuby, have evolved to the point where they transcend a simple “scripting language” on Android.

However, there are two other languages worth mentioning, as they are fairly well-known in Java circles: Groovy and Jython.

### Groovy

[Groovy](#) is perhaps the most popular Java-based language that does not have its roots in some other previous language (Java, JavaScript, Python, etc.). Designed in some respects to be a “better Java than Java”, Groovy gives you access to Java classes while allowing you to write scripts with dynamic typing, closures, and so forth. Groovy has an extensive community, complete with a fair number of Groovy-specific libraries and frameworks, plus some books on the market.

At the time of this writing, it does not appear that Groovy has been successfully ported to work on Android, though.

### Jython

[Jython](#) is an implementation of a Python language interpreter in Java. It has been around for quite some time, and gives you Python syntax with access to standard Java classes where needed. While the Jython community is not as well-organized as that of Groovy, there are plenty of books covering the use of Jython.

Jython's momentum has flagged a bit in recent months, in part due to Sun's waning interest in the technology and the departure of Sun employees from the project.

## JVM SCRIPTING LANGUAGES

---

One [attempt](#) to get Jython working with Android has been shut down, with people steered towards SL4A. It is unclear if others will make subsequent attempts.



# JUnit and Android

---

Presumably, you will want to test your code, beyond just playing around with it yourself by hand.

To that end, Android includes the JUnit test framework in the SDK, along with special test classes that will help you build test cases that exercise Android components, like activities and services. Even better, Android has “gone the extra mile” and can pre-generate your test harness for you, to make it easier for you to add in your own tests.

## Prerequisites

Understanding this chapter requires that you have read the core chapters of this book.

This chapter also assumes you have some familiarity with JUnit, though you certainly do not need to be an expert. You can learn more about JUnit at the [JUnit site](#), from various books, and from the [JUnit Yahoo forum](#).

## You Get What They Give You

An Android test project is complete set of Android project artifacts: manifest, source directories, resources, etc. Much of its structure is identical to a regular project. In fact, the generated test project is all ready to go, other than not having any tests. For example, the [Testing/JUnit](#) project has a tests/ subdirectory containing a test project set up to test various facets of one of our “show a list of 25 nonsense words” samples.

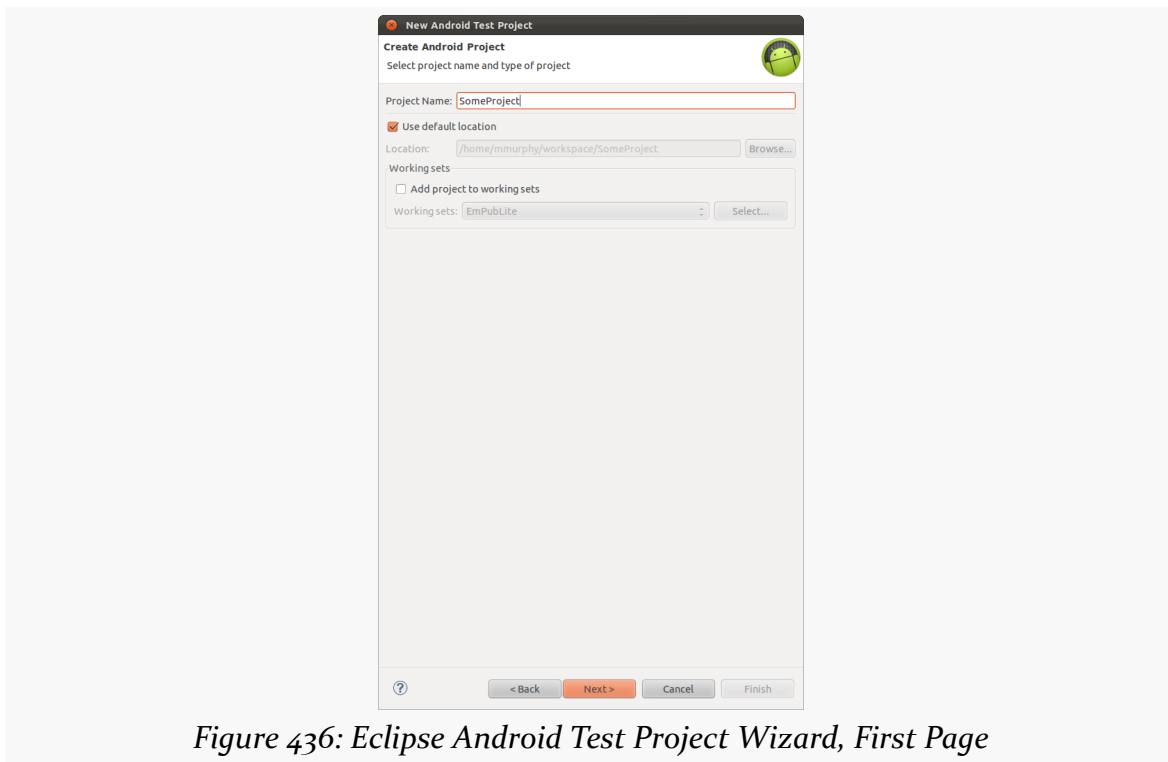


To create one of these test projects, you can either use Eclipse or the command line, as is the case with regular Android projects.

### Eclipse

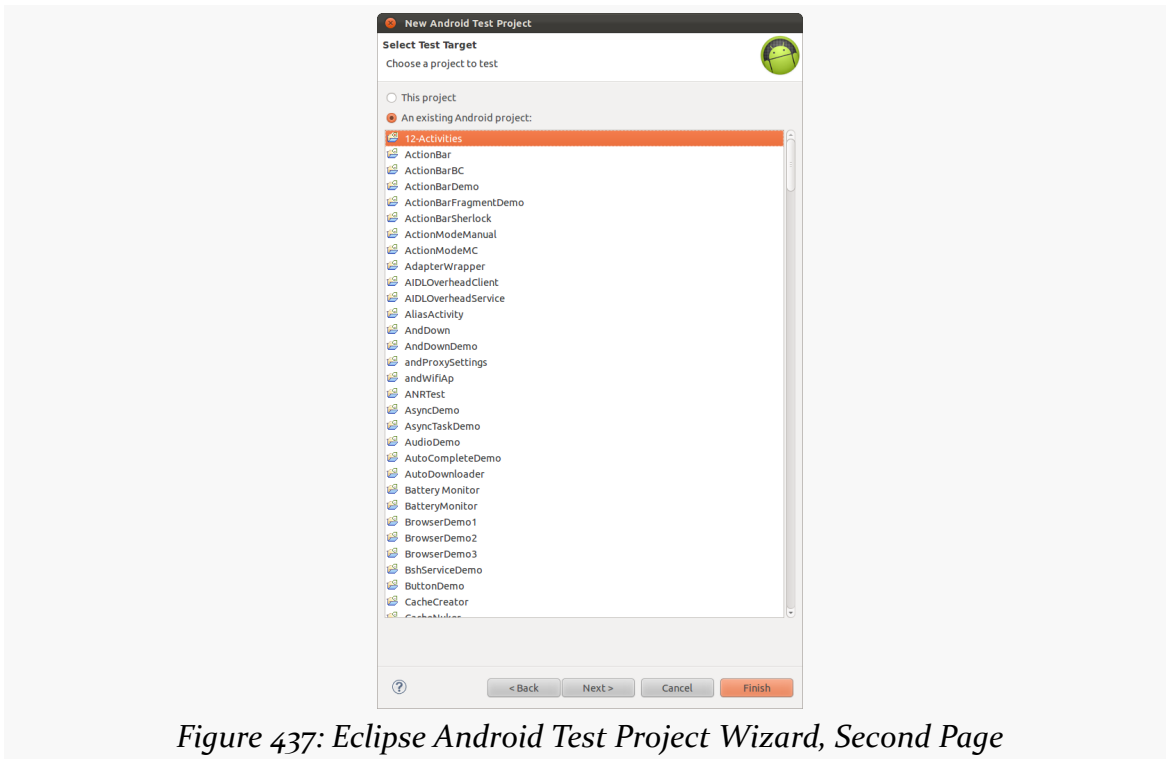
In the standard Eclipse new-project dialog (File > New > Project), choose “Android Test Project”.

The first page of the wizard will ask for your Eclipse settings, such as the project name:



*Figure 436: Eclipse Android Test Project Wizard, First Page*

The second page of the wizard has you pick from one of your Android projects the one that you wish to test:



*Figure 437: Eclipse Android Test Project Wizard, Second Page*

The last page of the wizard lets you specify the build target, which will be based on the build target of the project you specified in the second page:

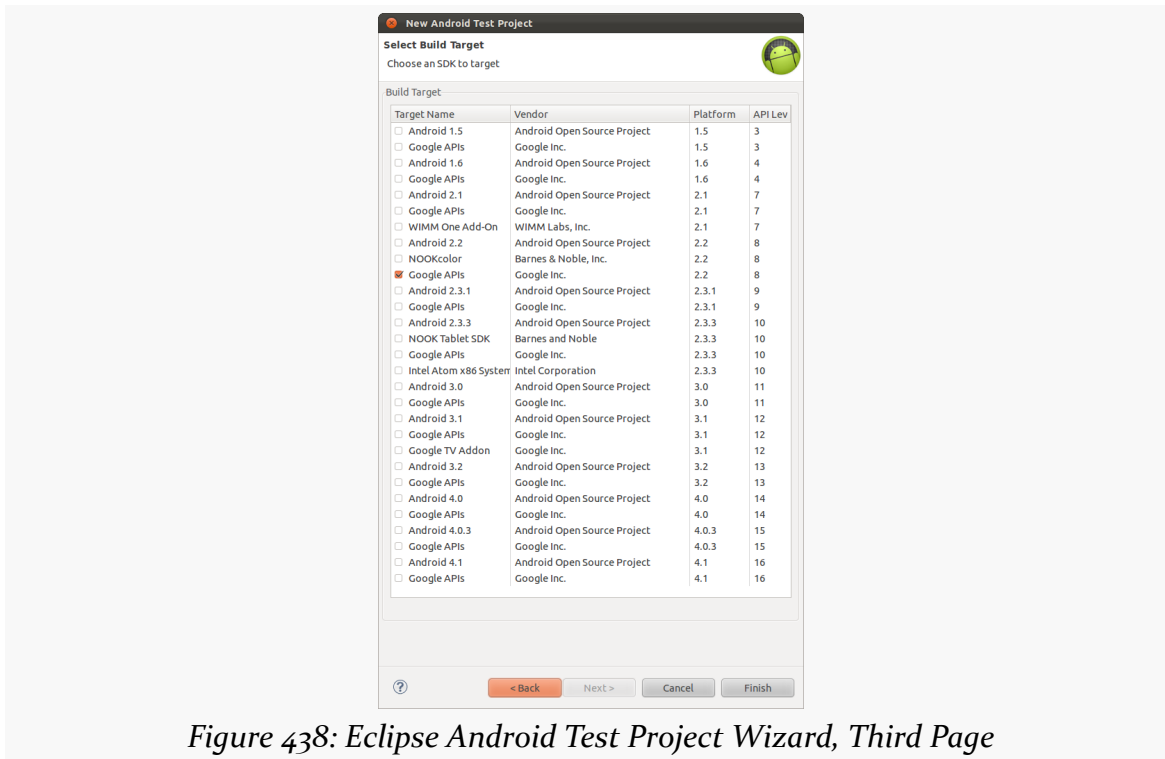


Figure 438: Eclipse Android Test Project Wizard, Third Page

## Command Line

From the command line, you use `android create project` to create a regular Android project. To create a project designed to test another project — what we will call a “test project” — you use the `android create test-project` command. From Eclipse, you can create a test project using the appropriate wizard. You will need to tell it which project to test, where you want the test project to reside, etc.

## Your Test Cases

A JUnit test project is made up of one (or potentially more) test suites, each comprising one (or usually more) test cases. A test case is a class, containing a series of test methods, designed to test some specific functionality. When a test case is run, JUnit:

- Creates an instance of the test case class
- Calls `setUp()`, where you can do any preparatory work
- Calls one of your test methods
- Calls `tearDown()` for post-test cleanup work

- Repeats the above steps for each test method

Hence, you need to write a series of test cases with test methods, and optionally `setUp()` and `tearDown()` as you see fit.

### POJTCs (Plain Old JUnit Test Cases)

For tests that have nothing much to do with Android, you can use the standard JUnit `TestCase` base class. This works the same as JUnit would outside of Android, and is useful for testing business logic on POJOs (plain old Java objects) and the like.

For example, here is a test case that is, well, silly:

```
package com.commonware.android.abf.test;

import junit.framework.TestCase;

public class SillyTest extends TestCase {
    protected void setUp() throws Exception {
        super.setUp();

        // do initialization here, run on every test method
    }

    protected void tearDown() throws Exception {
        // do termination here, run on every test method

        super.tearDown();
    }

    public void testNonsense() {
        assertTrue(1==1);
    }
}
```

All we have is a single test method — `testNonsense()` that validates that `1` really does equal `1`. Fortunately, this test usually succeeds. Our `TestCase` subclass (`SillyTest`) also implements `setUp()` and `tearDown()` for illustration purposes, as there is little preparation needed for our rigorous and demanding test method.

### ActivityInstrumentationTestCase2

While ordinary JUnit tests are certainly helpful, they are still fairly limited, since much of your application logic may be tied up in activities, services, and the like.

To that end, Android has a series of `TestCase` subclasses that you can extend designed specifically to assist in testing these sorts of components.

The one most people focus on is `ActivityInstrumentationTestCase2`. As the name suggests, this class will run your activity for you, giving you access to the `Activity` object itself. You can then:

1. Access your widgets
2. Invoke public and package-private methods (more on this below)
3. Simulate key events

Here are the steps to making use of `ActivityInstrumentationTestCase2`:

- Extend the class to create your own implementation. Since `ActivityInstrumentationTestCase2` is a generic, you need to supply the name of the activity being tested:

```
ActivityInstrumentationTestCase2<ActionBarFragmentActivity>
```

- In the constructor, when you chain to the superclass, supply the activity class itself.
- In `setUp()`, use `getActivity()` to get your hands on your `Activity` object, already typecast to the proper type (e.g., `ActionBarFragmentActivity`) courtesy of our generic. You can also at this time access any widgets, since the activity is up and running by this point.
- If needed, clean up stuff in `tearDown()`, no different than with any other JUnit test case.
- Implement test methods to exercise your activity.

For example, here is a short test case that exercises `ActionBarFragmentActivity`:

```
package com.commonware.android.abf.test;

import android.test.ActivityInstrumentationTestCase2;
import android.widget.ListView;
import com.commonware.android.abf.ActionBarFragmentActivity;

public class DemoActivityTest
    extends ActivityInstrumentationTestCase2<ActionBarFragmentActivity> {
    private ListView list=null;

    public DemoActivityTest() {
        super(ActionBarFragmentActivity.class);
    }

    @Override
```

```
protected void setUp() throws Exception {
    super.setUp();

    ActionBarFragmentActivity activity=getActivity();

    list=(ListView)activity.findViewById(android.R.id.list);
}

public void testListCount() {
    assertTrue(list.getAdapter().getCount()==25);
}
}
```

In `setUp()`, we get access to the `ListView` that makes up the bulk of our UI, so we have access to that widget in any test method. In `testListCount()`, we check our `ListAdapter` in the `ListView` to make sure we have all 25 of our nonsense words at the outset. This is fairly trivial and non-interactive. However, you could use methods like `sendKeys()` to simulate user input, to drive changes in your UI, so you can confirm the results worked as expected.

If you are looking at your emulator or device while this test is running, you will actually see the activity launched on-screen. `ActivityInstrumentationTestCase2` creates a true running copy of the activity. This means you get access to everything you need; on the other hand, it does mean that the test case runs slowly, since the activity needs to be created and destroyed for each test method in the test case. If your activity does a lot on startup and/or shutdown, this may make running your tests a bit sluggish.

Note that our `ActivityInstrumentationTestCase2` resides in a different package than the Activity it is testing. This restricts us to pure black-box testing. If, however, we elected to put the test case in the same package as the activity, we could also call any package-private methods, for a test that is closer to white-box in style. At runtime, the contents of both your regular application and the test application are combined into a single process in a single copy of the Dalvik VM, which is why your test code can access your application classes.

### AndroidTestCase

For tests that only need access to your application resources, you can skip some of the overhead of `ActivityInstrumentationTestCase2` and use `AndroidTestCase`. In `AndroidTestCase`, you are given a `Context` and not much more, so anything you can reach from a `Context` is testable, but individual activities or services are not.

While this may seem somewhat useless, bear in mind that a lot of the static testing of your activities will come in the form of testing the layout: are the widgets identified properly, are they positioned properly, does the focus work, etc. As it turns out, none of that actually needs an Activity object — so long as you can get the inflated View hierarchy, you can perform those sorts of tests.

Similarly, if you need to test business objects, but because they come from a database you need a Context for use with SQLiteOpenHelper, you could test those with an AndroidTestCase.

Here is a sample AndroidTestCase:

```
package com.commonware.android.abf.test;

import android.test.AndroidTestCase;
import android.view.LayoutInflater;
import android.view.View;
import android.view.ViewGroup;
import com.commonware.android.abf.R;

public class DemoContextTest extends AndroidTestCase {
    private View field=null;
    private ViewGroup root=null;

    @Override
    protected void setUp() throws Exception {
        super.setUp();

        LayoutInflater inflater=LayoutInflater.from(getContext());

        root=(ViewGroup)inflater.inflate(R.layout.add, null);
        root.measure(800, 480);
        root.layout(0, 0, 800, 480);

        field=root.findViewById(R.id.title);
    }

    public void testExists() {
        assertNotNull(field);
    }

    public void testPosition() {
        assertTrue(field.getTop() == 6);
        assertTrue(field.getLeft() > 0);
    }
}
```

Here, we manually inflate the contents of the res/layout/add.xml resource, and lay them out as if they were really in an activity, via calls to measure() and layout() to

simulate a WVGA800 display. At that point, we can start testing the widgets inside of that layout, from simple assertions to confirm that they exist, to testing their size and position.

### Other Test Cases

Android also offers various other test case base classes designed to assist in testing Android components, such as:

1. `ServiceTestCase`, used for testing services, as you might expect given the name
2. `ActivityUnitTestCase`, a `TestCase` that creates the Activity (like `ActivityInstrumentationTestCase`), but does not fully connect it to the environment, so you can supply a mock Context, a mock Application, and other mock objects to test out various scenarios
3. `ApplicationTestCase`, for testing custom Application subclasses

### Your Test Suite

You will want to organize your test cases into one or more test suites. Many test projects have a single suite. However, elaborate test projects may have different suites for different situations, each representing some subset of the total roster of test cases defined in the project.

The simplest way to set up a test suite is to use Android's built-in `TestSuiteBuilder` class, that pulls in a series of test cases based upon package name, such as the `FullSuite` class in our sample test project:

```
package com.commonware.android.abf.test;

import android.test.suitebuilder.TestSuiteBuilder;
import junit.framework.Test;
import junit.framework.TestSuite;

public class FullSuite extends TestSuite {
    public static Test suite() {
        return(new TestSuiteBuilder(FullSuite.class)
            .includeAllPackagesUnderHere()
            .build());
    }
}
```



Here, we are telling Android to find everything in this package (and sub-packages, if there were any) that implements `TestCase` and include it in the suite. Hence, organizing multiple suites would be a matter of organizing their test cases into separate packages and creating `TestSuite` classes per package.

## Running Your Tests

As with most things in Android, you can either use Eclipse or the command line to run your test suites.

### Eclipse

You run a test project in Android the same way that you run a regular project. However, when you get the “Run As” dialog, choose “Android JUnit Test”. However, if you have a single `TestCase` class selected in your Package Explorer, Android can run just that single test case, rather than the full thing — again, choose “Android JUnit Test” in the “Run As” dialog:



*Figure 439: Eclipse “Run As” Dialog for JUnit Test*

The results will be displayed in a JUnit view added to your Eclipse workspace, showing the successful and failed tests:

## JUNIT AND ANDROID

---

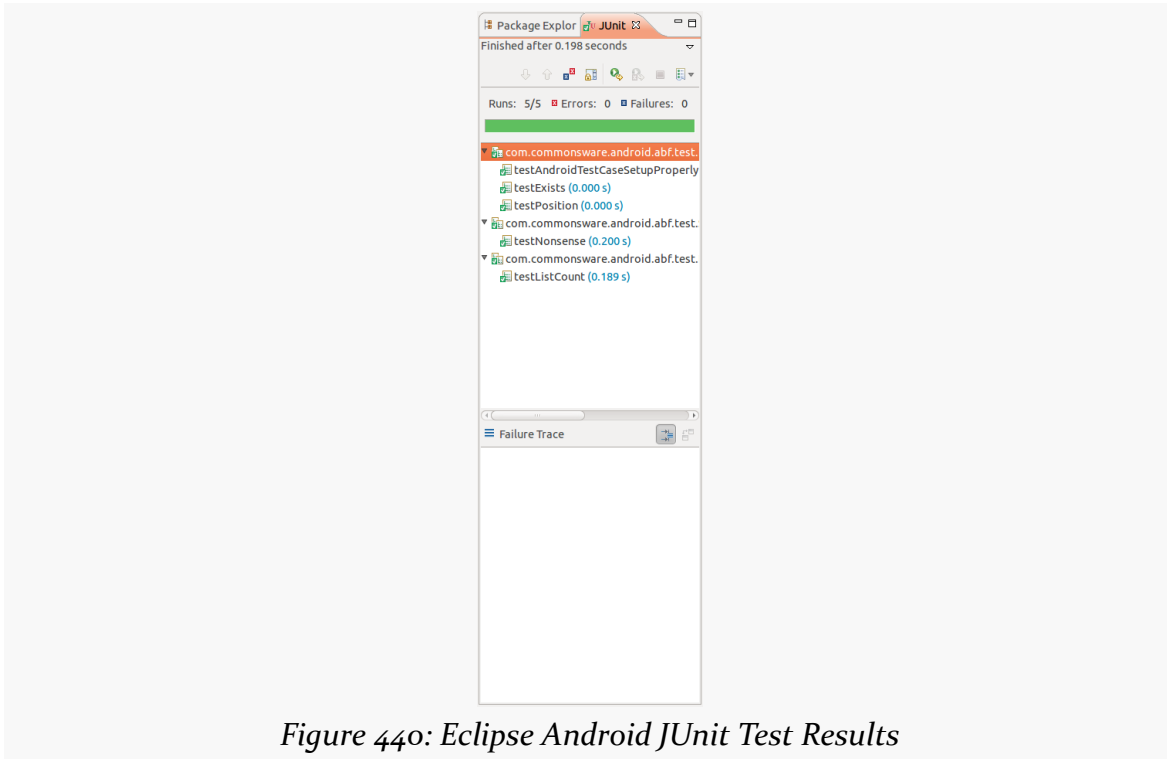


Figure 440: Eclipse Android JUnit Test Results

### Command Line

Android ships with a very rudimentary console JUnit runner, called `InstrumentationTestRunner`. Since this class resides in the Android environment (emulator or device), you need to invoke the runner to run your tests on the emulator or device itself. To do this, you can run `ant test` from a console. You should see results akin to:

```
test:
[echo] Running tests ...
[exec]
[exec] com.commonware.android.abf.test.DemoActivityTest:.
[exec] com.commonware.android.abf.test.DemoContextTest:...
[exec] com.commonware.android.abf.test.SillyTest:.
[exec] Test results for InstrumentationTestRunner=.....
[exec] Time: 0.173
[exec]
[exec] OK (5 tests)
[exec]
```



# **MonkeyRunner and the Test Monkey**

Many GUI environments have some means or another of “fuzz” or “bash” testing, where some test driver executes a bunch of random input, in hopes of catching errors (e.g., missing validation logic). Android offers the Test Monkey for this.

Many GUI environments have some means or another of scripting GUI events from outside the application itself, to simulate button clicks or touch events. Android offers MonkeyRunner for this.

As the names suggest, there is a bit of commonality in their implementation. And, as you might expect, there is a bit of commonality in their coverage in this book — we will examine both MonkeyRunner and the Test Monkey in this chapter.

## **Prerequisites**

Understanding this chapter requires that you have read the core chapters of this book.

## **MonkeyRunner**

MonkeyRunner is a means of creating test suites for Android applications based off of scripted UI input. Rather than write a series of JUnit test cases or the like, you create Jython (JVM implementation of Python) scripts that run commands to install apps, execute GUI events, and take screenshots of results.

### Writing a MonkeyRunner Script

The primary object you will work with in a MonkeyRunner script is a `MonkeyDevice`, which represents your connection to the device or emulator that you are testing. You obtain a `MonkeyDevice` by calling `waitForConnection()` on `MonkeyRunner`; this will return once it has established a connection.

From there, `MonkeyDevice` lets you send events to the device or emulator:

- `installPackage()` allows you to install an APK from your development machine, and `removePackage()` allows you to get rid of it
- `startActivity()` and `broadcastIntent()` allow you to start up components of your app
- `press()` to simulate key events, including QWERTY keys, standard device keys like BACK, D-pad/trackball events, and anything else represented by a standard Android `KeyEvent`
- `type()` to simulate entering a whole string, as a simplification over calling `press()` once per letter
- `touch()` and `drag()` let you simulate touch events
- and so on

The biggest limitation is in getting data out of the device, to determine if your test worked successfully. Your options are:

- `takeSnapshot()`, which will capture a screenshot that you can save to disk, compare with other screenshots, etc.
- `shell()` executes `adb shell` commands, returning any results
- ...and that's about it

Unlike [JUnit-based testing](#), you have no visibility into the activity beyond what appears on the screen — you cannot inspect widgets, call methods, or the like.

For example, here is a script that installs an app, runs an activity from it, and presses the down button on the D-pad three times:

```
from com.android.monkeyrunner import MonkeyRunner, MonkeyDevice

device = MonkeyRunner.waitForConnection()
device.installPackage('bin/JUnitDemo.apk')
device.startActivity(component='com.commonware.android.abf/
com.commonware.android.abf.ActionBarFragmentActivity')
device.press('KEYCODE_DPAD_DOWN', MonkeyDevice.DOWN_AND_UP)
device.press('KEYCODE_DPAD_DOWN', MonkeyDevice.DOWN_AND_UP)
```

```
device.press('KEYCODE_DPAD_DOWN', MonkeyDevice.DOWN_AND_UP)
# result = device.takeSnapshot()
# result.writeToFile('tests/monkey_sample_shots/test1.png', 'png')
```

### Executing MonkeyRunner

To execute your MonkeyRunner script, have your device or emulator set up at a likely starting point (e.g., home screen), then execute the `monkeyrunner` command, passing it the path to your script (e.g., `monkeyrunner monkey_sample.py`). You will see the script executing on the screen of your device or emulator, and your console will contain whatever output you might emit from your test script itself. For example, you might take screenshots, compare them against a master copy (using methods on `MonkeyImage` to help with this), and emit warnings if they differ unexpectedly.

### Monkeying Around

Independent from the JUnit system and MonkeyRunner is the Test Monkey (referred to here as “the Monkey” for short).

The Monkey is a test program that simulates random user input. It is designed for “bash testing”, confirming that no matter what the user does, the application will not crash. The application may have odd results — random input entered into a Twitter client may, indeed, post that random input to Twitter. The Monkey does not test to make sure that results of random input make sense; it only tests to make sure random input does not blow up the program.

You can run the Monkey by setting up your initial starting point (e.g., the main activity in your application) on your device or emulator, then running a command like this:

```
adb shell monkey -p com.commonware.android.abf -v --throttle
100 600
```

(substituting the package name of a project on your device or emulator for `com.commonware.android.abf`)

Working from right to left, we are asking for 600 simulated events, throttled to run every 100 milliseconds. We want to see a list of the invoked events (`-v`) and we want to throw out any event that might cause the Monkey to leave our application, as determined by the application’s package (`-p com.commonware.android.abf`).

## MONKEYRUNNER AND THE TEST MONKEY

---

The Monkey will simulate keypresses (both QWERTY and specialized hardware keys, like the volume controls), D-pad/trackball moves, and sliding the keyboard open or closed. Note that the latter may cause your emulator some confusion, as the emulator itself does not itself actually rotate, so you may end up with your screen appearing in landscape while the emulator is still, itself, portrait. Just rotate the emulator a couple of times (e.g., <Ctrl>-<F12>) to clear up the problem.

For playing with a Monkey, the above command works fine. However, if you want to regularly test your application this way, you may need some measure of repeatability. After all, the particular set of input events that trigger your crash may not come up all that often, and without that repeatable scenario, it will be difficult to repair the bug, let alone test that the repair worked.

To deal with this, the Monkey offers the `-s` switch, where you provide a seed for the random number generator. By default, the Monkey creates its own seed, giving totally random results. If you supply the seed, while the sequence of events is random, it is random for that seed — repeatedly using the same seed will give you the same events. If you can arrange to detect a crash and know what seed was used to create that crash, you may well be able to reproduce the crash.

There are many more Monkey options, to control the mix of event types, to generate profiling reports as tests are run, and so on. The [Monkey documentation](#) in the SDK's Developer's Guide covers all of that and more.

# Advanced Emulator Capabilities

---

The Android emulator, at its core, is not that complex. Once you have one or more Android virtual devices (AVDs) defined, using them is a matter of launching the emulator and installing your app upon it. With Eclipse, those two steps can even be combined — Eclipse will automatically start an emulator instance if one is needed.

However, there is much more to the Android emulator. This chapter will explore various advanced features of the emulator and how you can use them.

## Prerequisites

Understanding this chapter requires that you have read the core chapters of this book.

## x86 Images

Normally, the Android emulator emulates a device with an ARM-based CPU. That matches with most Android devices available to users today. However, most developers are developing on an x86-based development machine, not one powered by ARM. As a result, the normal Android emulator has to convert ARM instructions to x86 instructions before executing them, slowing down performance.

Some versions of the Android emulator, though, have an x86 version as well. Where available, these *can* run much more quickly than will their ARM counterparts on an x86 development machine.

The emphasis on *can* is that your development machine must have things set up properly first. Linux users need KVM, while Mac and Windows users need the “Intel



## ADVANCED EMULATOR CAPABILITIES

Hardware Accelerated Execution Manager” (available from the SDK Manager). The latter must be manually installed once downloaded — please consult [the Android tools documentation](#) for details.

Also, this only works for certain CPU architectures, ones that support virtualization in hardware:

- Intel Virtualization Technology (VT, VT-x, vmx) extensions
- AMD Virtualization (AMD-V, SVM) extensions (Linux only)

Those virtualization extensions must also be enabled in your device’s BIOS, and other OS-specific modifications may be required.

### Android 4.0.3

An x86 image for Android 4.0.3 is available from your SDK Manager:

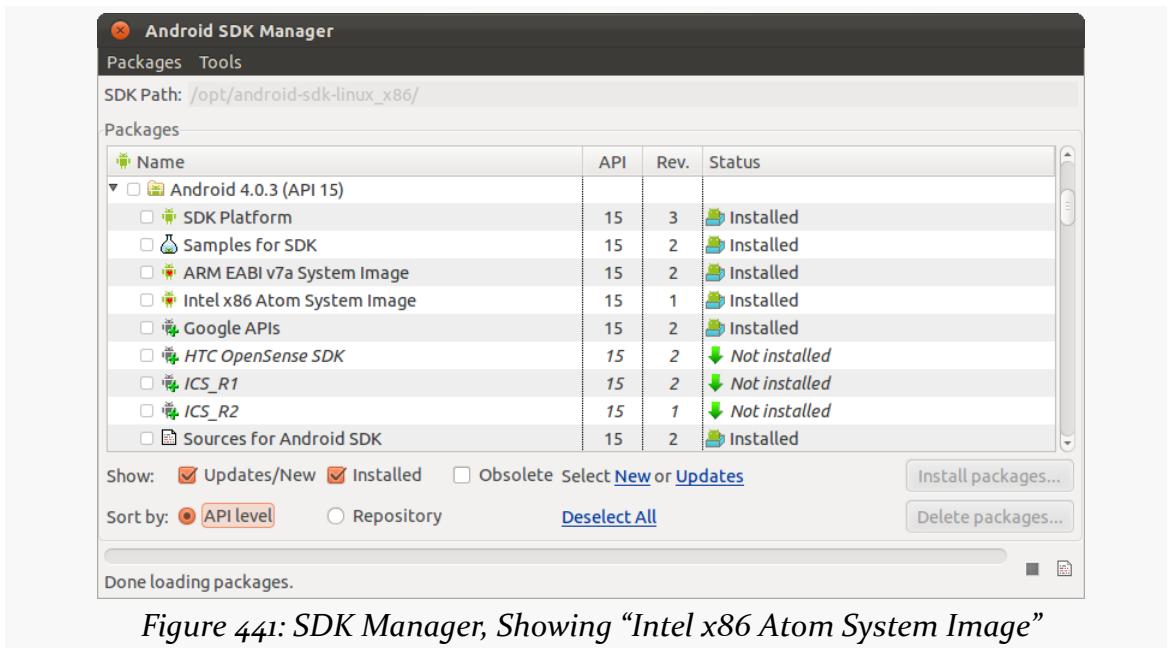


Figure 441: SDK Manager, Showing “Intel x86 Atom System Image”

When you download that, the next time you choose API Level 15 for an AVD, you will have an option of CPU architecture:

## ADVANCED EMULATOR CAPABILITIES

---

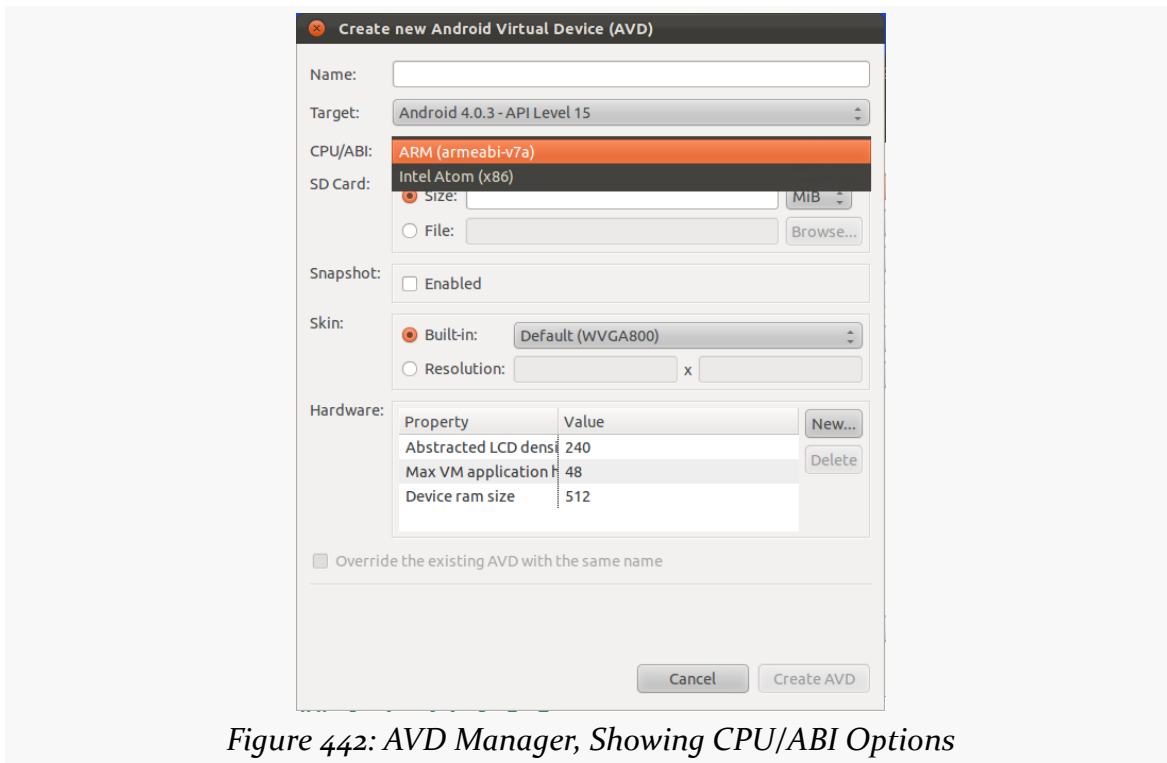


Figure 442: AVD Manager, Showing CPU/ABI Options

Note that this only works for the plain Android API Level 15 AVD, not the one containing Google Maps, which is only available for ARM at this time.

### Android 2.3.3

An x86 image for Android 2.3.3 is also available from your SDK Manager, though with a slightly different entry:

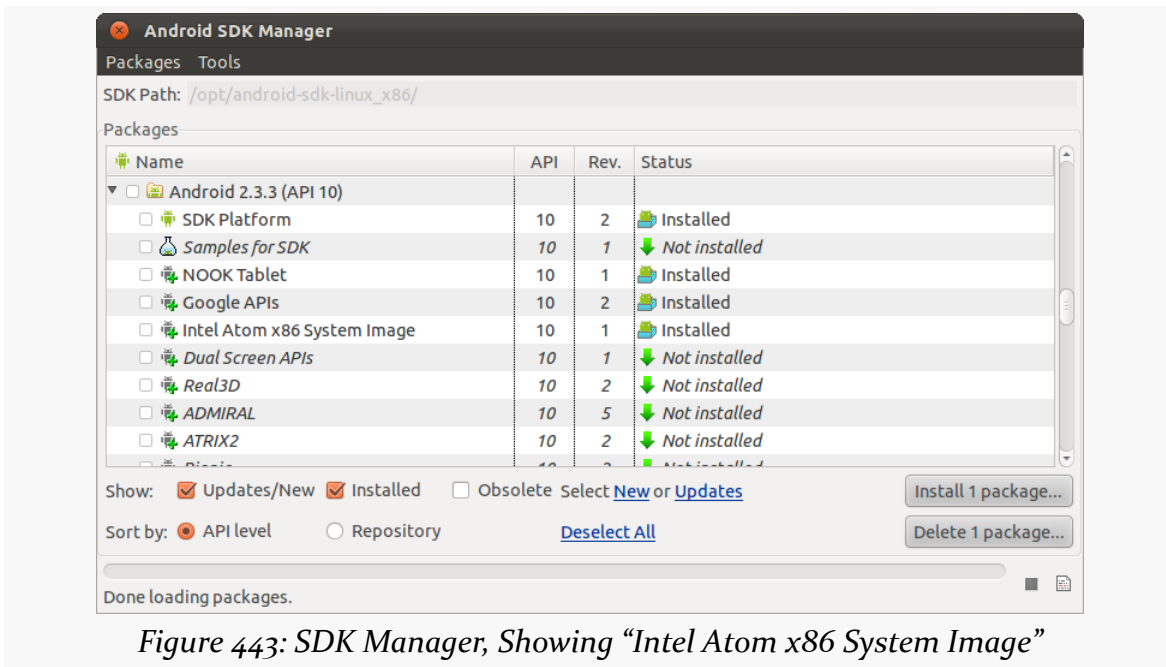


Figure 443: SDK Manager, Showing “Intel Atom x86 System Image”

This shows up as a separate target in your AVD Manager (“Intel Atom x86 System Image”), rather than a CPU/ABI value that you toggle.

## Hardware Graphics Acceleration

The other way to speed up the emulator is to have it use the graphic card or GPU of your development machine to accelerate the graphics rendering of the emulator window. By default, the emulator will use software-based rendering, without the GPU, which is slow in general and worse when running an ARM-based image.

To try using GPU emulation, for an AVD (new or existing), click the “New...” button to the right of the list of hardware options in the AVD configuration editor:

## ADVANCED EMULATOR CAPABILITIES

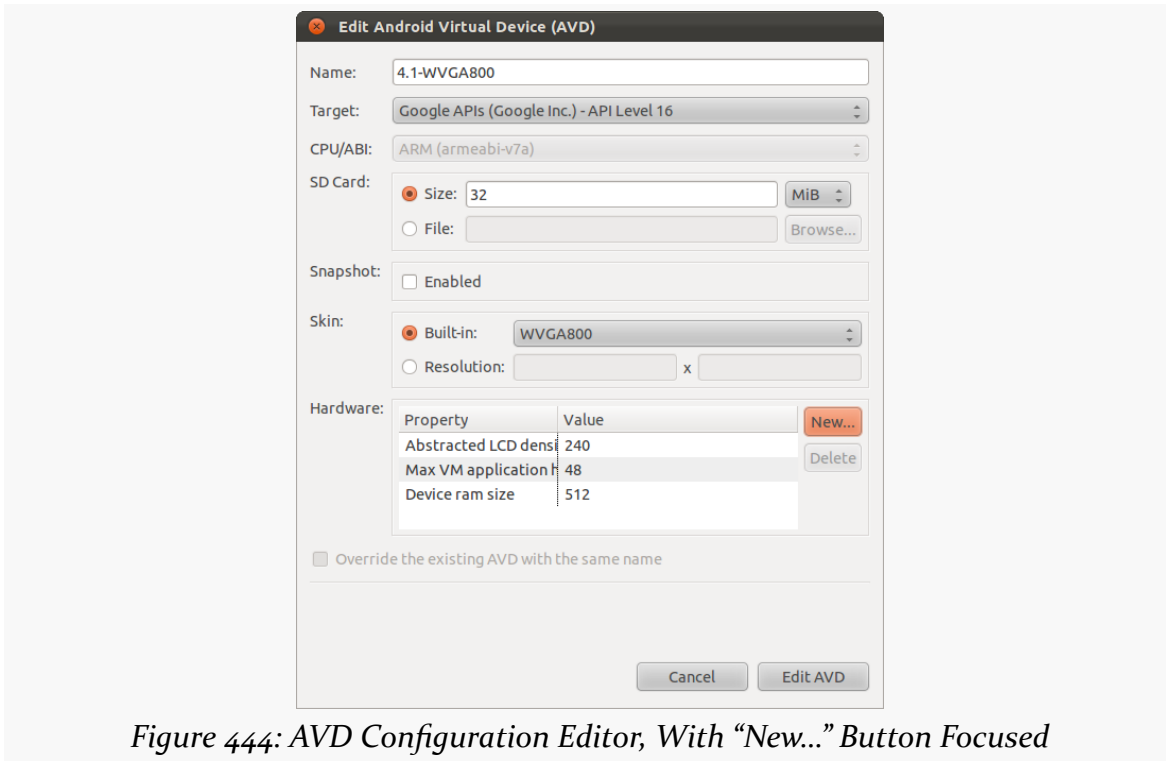


Figure 444: AVD Configuration Editor, With “New...” Button Focused

In the dialog that appears, choose “GPU Emulation” in the drop-down:

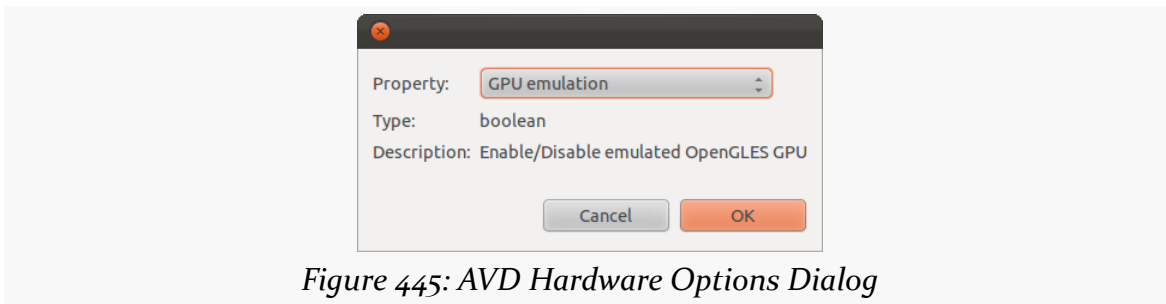


Figure 445: AVD Hardware Options Dialog

Then click OK, which will add “GPU Emulation” to the table:

## ADVANCED EMULATOR CAPABILITIES

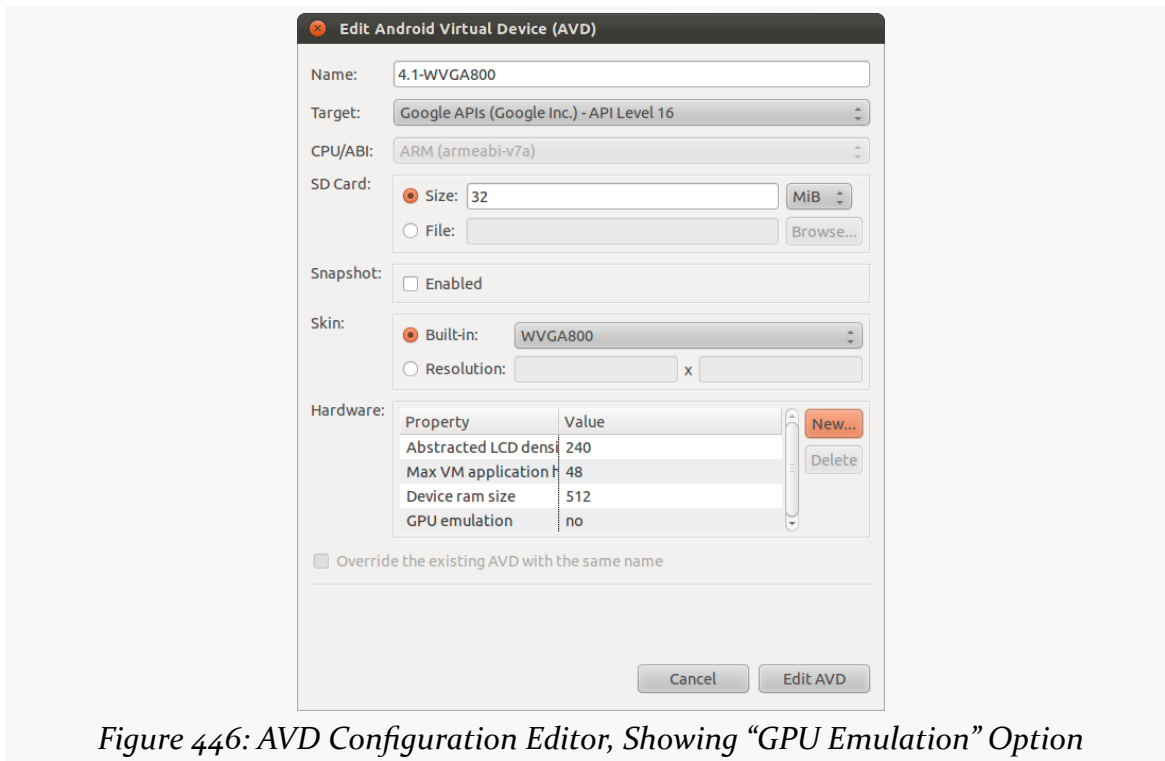


Figure 446: AVD Configuration Editor, Showing “GPU Emulation” Option

If it has “no” as the corresponding value — and it should by default — click on the “no” to display a drop-down where you can toggle it to “yes”.

Also, you need to make sure that the “Enabled” checkbox in the Snapshot group box is unchecked.

Whether this will work or not for you will depend in part upon your graphics drivers of your development machine.

## Keyboard Behavior

The Android emulator can emulate devices that have, or do not have, an physical keyboard. Most Android devices do not have a physical keyboard, and so the emulator is set up to behave the same. However, this means that typing on your development machine’s keyboard will not work in EditText widgets and the like — you have to tap out what you want to type on the on-screen keyboard.

If you wish to switch your emulator to emulate a device with a physical keyboard — either “for realz” or just to simplify working with the emulator on your development

machine — click that “New...” button next to the list of hardware options, as described in the preceding section. Choose “Keyboard support” from the drop-down, click OK, and toggle the value for that hardware option to “yes”.

## Navigation Button Behavior

Similarly, the emulator can emulate devices that either have or do not have off-screen navigation buttons, notably HOME, BACK, and MENU. The “Hardware Back/Home keys” hardware option controls this — add this via the “New...” button adjacent to the list of hardware options, as described in the preceding two sections. Set it to “yes” to emulate a device with off-screen buttons (e.g., a Nexus S), or “no” to emulate a device without off-screen buttons (e.g., a Galaxy Nexus). On phone-sized emulator screens, this controls whether or not the navigation bar appears at the bottom, intruding into your available screen space.

## Headless Operation

Sometimes, you want an emulator without a GUI. Typically, this is used for continuous integration or some other server-based testing solution — you use the “headless” emulator to run tests, even on a machine that lacks any GUI capability.

To do this, you will need to run the emulator from the command-line. Run `emulator -no-window -avd ...`, where ... is the name of your AVD (e.g., the value in the left column of the list of AVDs in the AVD Manager). To test this first in normal mode, run the command without the `-no-window` switch.

The simplest solution to get rid of the emulator instance is to kill its process.

There are many other [command-line switches for the emulator](#) that you may wish to investigate. While most of these have UI analogues in the AVD Manager, the switches would be necessary to replicate some of those for headless operation.



# Using Lint

---

As C/C++ developers are well aware, `lint` is not merely something that collects in pockets and belly buttons.

`lint` is a long-standing C/C++ utility that points out issues in a code base that are not errors or warnings, but are still indicative of a likely flaw in the code. After all, what might be legal from a syntax standpoint may still be a bug when used.

The Android tools now have their own equivalent tool, Lint, integrated into Eclipse and available from the command line, for reporting similar sorts of issues with an Android project's Java code, resources, and manifest.

## Prerequisites

Understanding this chapter requires that you have read the core chapters of this book.

## What It Is

Lint can be best described as “a pest, but a good pest”.

Normally, what stops you from building your app are compiler errors: bad Java syntax, malformed XML resource files, and the like. At the command line, these stop an in-progress build and dump error messages to the console. In Eclipse, these result in red “X” notations on the files in the Package Explorer, and frequently result in red squiggle lines underneath the offending Java or XML when viewed in an editor. You also may get yellow squiggle lines for warnings — things the compiler will allow but the compiler thinks may be a problem.



## USING LINT

However, there are many things that might be syntactically valid but are not a good idea from an Android standpoint. For example, if you specify a minimum SDK version of API Level 8, and you try using a class that only exists on API Level 11, that's a problem if you are not handling it correctly and avoiding this class on the older-yet-supported devices. Yet, if your build target is API Level 11 or higher, it is perfectly valid syntax and would compile just fine.

Lint is designed to encapsulate rules that transcend syntax, to add more errors and warnings that reflect good Android practices beyond simple validity.

## When It Runs

By default, in Eclipse, Lint will run when you save a file and when you export an APK (e.g., to distribute in production). You can also force a full Lint run in Eclipse at any point by clicking its toolbar button (looks like a green checkmark in a box), or by right-clicking over a project and choosing Android Tools > Run Lint from the context menu. In addition to giving you classic Eclipse error and warning markers in the files, there is also a “Lint Warnings” view showing a table of all the errors and warnings in one place:

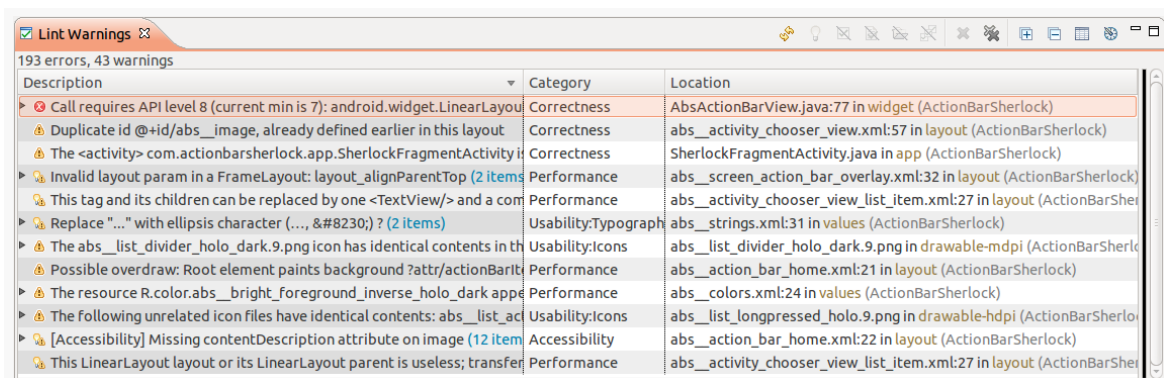


Figure 447: Eclipse Lint Warnings View

To run Lint from the command line, just run `lint`, passing it the path to some directory. If the directory is an Android project directory, `lint` will dump the errors and warnings to the console. If the directory is not an Android project directory, `lint` will sweep all subdirectories to find any Android projects, then report those projects' errors and warnings.

```
$ lint .
```

```
Scanning .:
```

## USING LINT

---

```
.....
Scanning . (Phase 2): ..
res/drawable/eject.png: Warning: The resource R.drawable.eject appears to be
unused [UnusedResources]
res/values/strings.xml:3: Warning: The resource R.string.app_name appears to be
unused [UnusedResources]
  <string name="app_name">AudioDemo</string>
  ^
res/drawable-hdpi: Warning: Missing the following drawables in drawable-hdpi:
cw.png (found in drawable-mdpi) [IconDensities]
res: Warning: Missing density variation folders in res: drawable-xhdpi
[IconMissingDensityFolder]
res/layout/main.xml:13: Warning: [Accessibility] Missing contentDescription
attribute on image [ContentDescription]
  <ImageButton android:id="@+id/play"
  ^
res/layout/main.xml:35: Warning: [Accessibility] Missing contentDescription
attribute on image [ContentDescription]
  <ImageButton android:id="@+id/pause"
  ^
res/layout/main.xml:56: Warning: [Accessibility] Missing contentDescription
attribute on image [ContentDescription]
  <ImageButton android:id="@+id/stop"
  ^
res/layout/main.xml:21: Warning: [I18N] Hardcoded string "Play", should use
@string resource [HardcodedText]
  android:text="Play"
  ^
res/layout/main.xml:42: Warning: [I18N] Hardcoded string "Pause", should use
@string resource [HardcodedText]
  android:text="Pause"
  ^
res/layout/main.xml:63: Warning: [I18N] Hardcoded string "Stop", should use
@string resource [HardcodedText]
  android:text="Stop"
  ^
0 errors, 10 warnings
```

However, frequently it is more convenient as a developer to have the command-line lint generate an HTML report, instead of dumping everything just to the console. To do that, use the `--html` switch, passing a path to the report file to be generated. For local use, that is all you need. If you wish to host the report somewhere, also add the `--url` switch, indicating where the report will live on a Web server (e.g., your continuous integration server). For example, this command runs lint in the current working directory, generating a `/tmp/lint.html` file (plus a `/tmp/lint_files/` directory of images and CSS files), mapping the URLs to work on a specific base URL:

```
lint --html /tmp/lint.html --url .=http://misc.commonsware.com/lint
```

This report [can be viewed in your Web browser](#) to see what the output looks like.

## What to Fix

Inside of Eclipse, some of the Lint warnings and errors come with “quick fixes”, which you can bring up via <Ctrl>-<1>. For example:

- Errors related to accessing classes or methods higher than your `minSdkVersion` have “quick fixes” to add the `@TargetApi` annotation to the class or method containing your code
- Warnings related to hard-coded strings in layouts or the manifest have “quick fixes” to convert those strings into string resources

All warnings and errors will have “quick fixes” to suppress that warning or error in the future, by adding notations to the file to that effect.

## What to Configure

You have some measure of control over Lint’s behavior. The exact means of doing so varies significantly depending upon whether you are using Eclipse or running Lint from the command line.

### Eclipse

In Eclipse, you can configure Lint’s behavior via Eclipse’s Preferences dialog. Go into Android > Lint Error Checking to see your available options:

## USING LINT

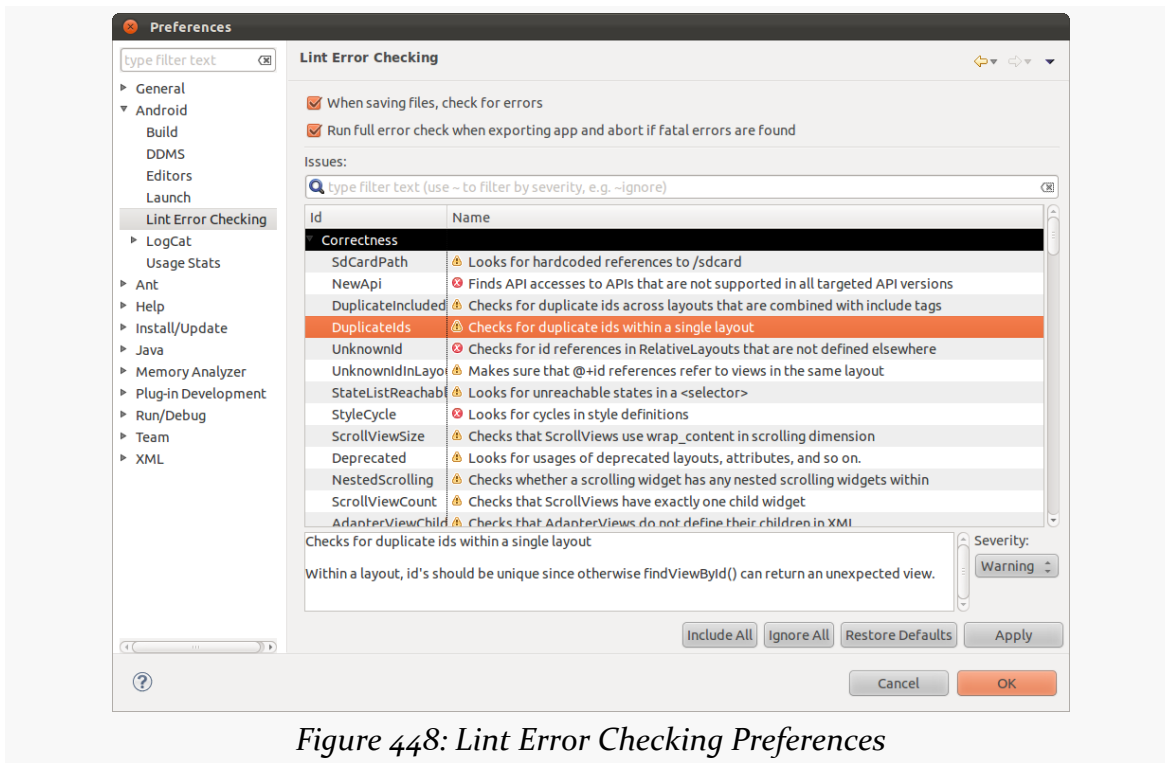


Figure 448: Lint Error Checking Preferences

In addition to configuring the automatic Lint checks (e.g., on each file save), you can change some details about the specific checks that Lint makes:

- the severity of the issue, usually set to Warning or Error
- whether the specific issue should be ignored rather than executed

To change Lint behavior on a per-project basis, go into the project properties, click on the “Android Lint Preferences” category, and you will see a similar table of issues, which you can configure for this specific project.

Also, from the “Lint Warnings” view, you can elect to suppress certain warnings, either for the entire workspace, the entire project, or for the specific file in which the warning is being presented.

### Command Line

One way to suppress issues from the command line is to add the `--disable` switch, listing the issues (or categories of issues) to skip. You can use the `--list` switch to see what checks are available:

## USING LINT

---

```
$ lint --list
Valid issue categories:
  Correctness
  Correctness:Messages
  Security
  Performance
  Usability:Typography
  Usability:Icons
  Usability
  Accessibility
  Internationalization

Valid issue id's:
"ContentDescription": Ensures that image widgets provide a contentDescription
"FloatMath": Suggests replacing java.lang.Math calls with
  android.util.FloatMath to avoid conversions
"FieldGetter": Suggests replacing uses of getters with direct field access
  within a class
"SdCardPath": Looks for hardcoded references to /sdcard
"NewApi": Finds API accesses to APIs that are not supported in all targeted
  API versions
"DuplicateIncludedIds": Checks for duplicate ids across layouts that are
  combined with include tags
"DuplicateIds": Checks for duplicate ids within a single layout
"UnknownId": Checks for id references in RelativeLayouts that are not defined
  elsewhere
...
```

(where the ... is simply a truncation of the list shown here, which is very long)

If, for example, you wanted to run lint and skip all performance issues, you could use `lint --disable Performance`. If you are uncertain what a particular issue means, the `--show` switch can dump details about the issue:

```
$ lint --show FieldGetter
FieldGetter
-----
Summary: Suggests replacing uses of getters with direct field access within a
class

Priority: 4 / 10
Severity: Warning
Category: Performance
NOTE: This issue is disabled by default!
You can enable it by adding --enable FieldGetter

Accessing a field within the class that defines a getter for that field is at
least 3 times faster than calling the getter. For simple getters that do
nothing other than return the field, you might want to just reference the
local field directly instead.
```

## USING LINT

---

More information: [http://developer.android.com/guide/practices/design/performance.html#internal\\_get\\_set](http://developer.android.com/guide/practices/design/performance.html#internal_get_set)

Another option is to create a `lint.xml` file, in the root directory of your project, containing information about which particular issues should be suppressed for that project. The benefit here is that you can configure suppression at a finer granularity, blocking issues for certain files or directories and allowing them for others. The sample `lint.xml` from [the Lint documentation](#) looks like this:

```
<?xml version="1.0" encoding="UTF-8"?>
<lint>
  <!-- Disable the given check in this project -->
  <issue id="IconMissingDensityFolder" severity="ignore" />

  <!-- Ignore the ObsoleteLayoutParam issue in the given files -->
  <issue id="ObsoleteLayoutParam">
    <ignore path="res/layout/activation.xml" />
    <ignore path="res/layout-xlarge/activation.xml" />
  </issue>

  <!-- Ignore the UselessLeaf issue in the given file -->
  <issue id="UselessLeaf">
    <ignore path="res/layout/main.xml" />
  </issue>

  <!-- Change the severity of hardcoded strings to "error" -->
  <issue id="HardcodedText" severity="error" />
</lint>
```

You can also have a similar `lint.xml` file that you use outside of any project, by passing in the `--config` switch pointing to it.



# Using Hierarchy View

---

Android comes with a Hierarchy View tool, designed to help you visualize your layouts as they are seen in a running activity in a running emulator. So, for example, you can determine how much space a certain widget is taking up, or try to find where a widget is hiding that does not appear on the screen.

## Prerequisites

Understanding this chapter requires that you have read the core chapters of this book.

## Launching Hierarchy View

To use the Hierarchy View, you first need to fire up your emulator, install your application, launch your activity, and navigate to the spot you wish to examine. Note that you cannot use Hierarchy View with a production Android device [without some help](#).

To launch Hierarchy View, you have two options:

1. From Eclipse, open the Hierarchy View perspective
2. From the command line, run the `monitor` program to bring up the Android Device Monitor, choose Window > Open Perspective from the main menu, and open Hierarchy View



## USING HIERARCHY VIEW

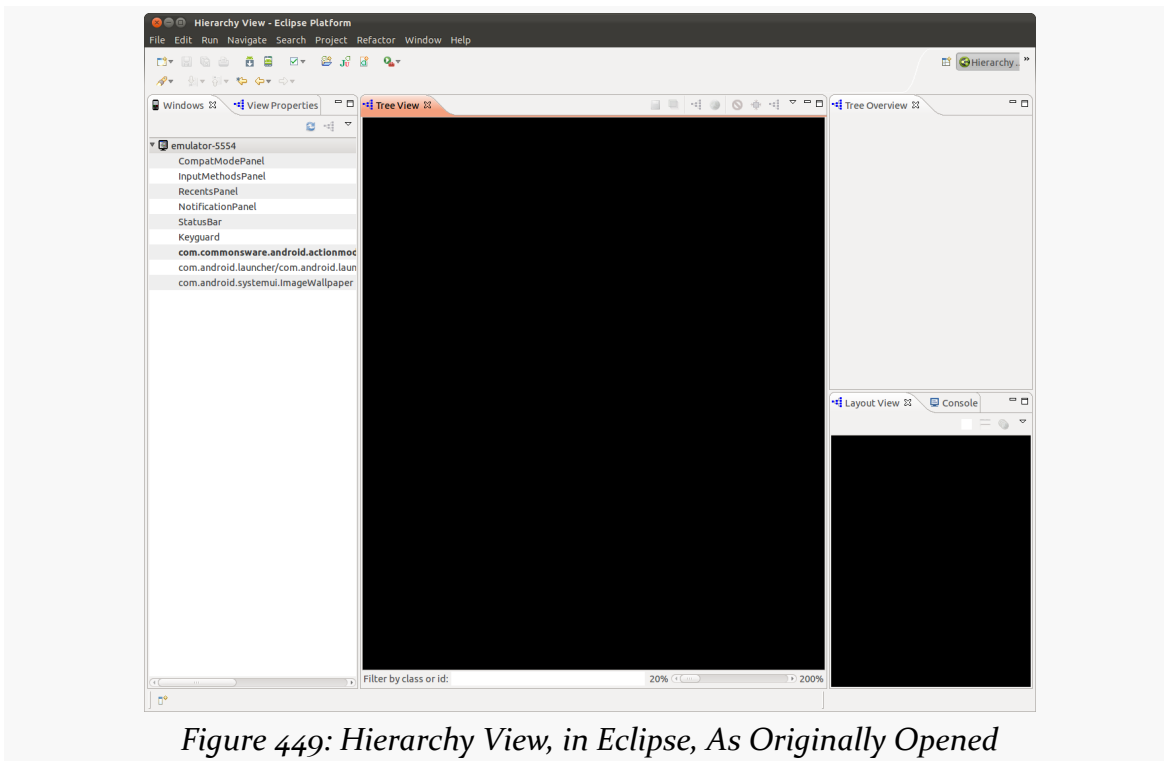


Figure 449: Hierarchy View, in Eclipse, As Originally Opened

The roots of the tree-table on the left show the emulator instances presently running on your development machine. The leaves represent applications running on that particular emulator. Your activity will be identified by application package and class (e.g., `com.commonsware.android.files/...`).

### Viewing the View Hierarchy

Where things get interesting, though, is when you double-click on your activity in the tree-table. After a few seconds, the details spring into, er, view:

## USING HIERARCHY VIEW

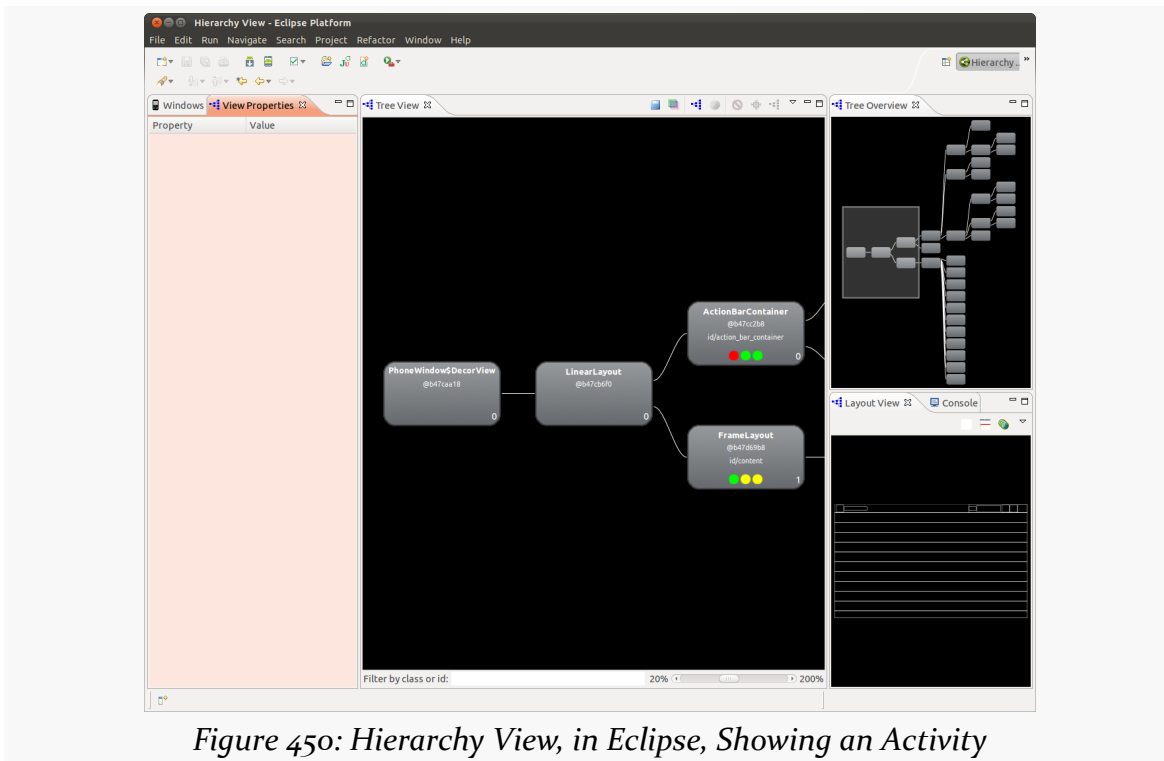


Figure 450: Hierarchy View, in Eclipse, Showing an Activity

The main area of the Layout View shows a tree of the various widgets and stuff that make up your activity, starting from the overall system window and driving down into the individual UI widgets that users are supposed to interact with. This includes both widgets and containers defined by your application and others that are supplied by the system, including the title bar.

Clicking on one of the views adds more information to this perspective:

## USING HIERARCHY VIEW

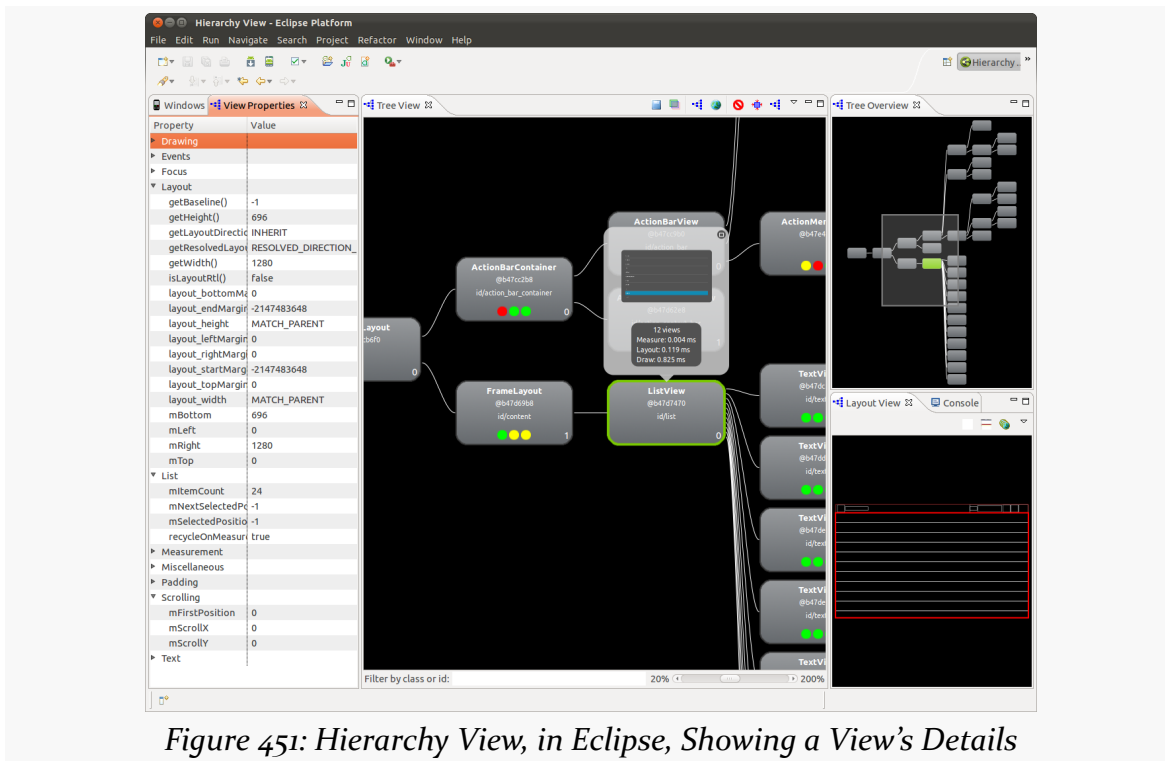


Figure 451: Hierarchy View, in Eclipse, Showing a View's Details

Now, we get:

- In the left region of the Viewer, we see the properties of the selected widget or container, in its own tree-table.
- In the Tree View in the middle, the selected widget or container has a pop-up bubble with what that particular View looks like on the screen, along with some performance timing data.
- In the Tree Overview in the upper-right portion of the tool, our selected View is highlighted in green.
- In the Layout View in the lower-right portion of the tool, our selected View is highlighted in red in the wireframe.

From the toolbar above the Tree View, you can:

- Save the tree diagram as a PNG file
- Save the UI as a Photoshop PSD file, with different layers for the different widgets and containers
- Force the UI to repaint in the emulator or re-load the hierarchy, in case you have made changes to a database or to the app's contents and need a fresh diagram

### ViewServer

One major limitation of Hierarchy View is that it only works with the emulator by default. There is no means for it to pull information from random activities running on production hardware.

However, Romain Guy, one of the core Android engineers, has published [a ViewServer open-source component](#) that gets around this limitation.

If you add the ViewServer source code to your project, and register your activities as they are created (and remove them when they are destroyed), you will be able to use Hierarchy View with them. However, this is a bit dangerous on a production app, so you should strongly consider using `BuildConfig.DEBUG` to only enable this logic in debug builds.

Blending in the `BuildConfig.DEBUG` concept with Mr. Guy's supplied sample usage, we get something like this:

```
public class MyActivity extends Activity {
    public void onCreate(Bundle savedInstanceState) {
        super.onCreate(savedInstanceState);

        // Set content view, etc.

        if (BuildConfig.DEBUG) ViewServer.get(this).addWindow(this);
    }

    public void onDestroy() {
        if (BuildConfig.DEBUG) ViewServer.get(this).removeWindow(this);

        super.onDestroy();
    }

    public void onResume() {
        super.onResume();

        if (BuildConfig.DEBUG) ViewServer.get(this).setFocusedWindow(this);
    }
}
```

Also note that ViewServer requires that your application hold the `INTERNET` permission, which you may already have requested for other reasons.



# Using DDMS

---

Another tool in the Android developer’s arsenal is the Dalvik Debug Monitor Service (DDMS). This is a “Swiss army knife”, allowing you to do everything from browse log files, update the GPS location provided by emulator, simulate incoming calls and messages, and browse the on-emulator storage to push and pull files.

We have already seen the use of DDMS [for viewing your logs via the LogCat view](#). This chapter will explore a few other uses of DDMS beyond LogCat.

## Prerequisites

Understanding this chapter requires that you have read the core chapters of this book, particularly [the chapter on using LogCat](#).

While not strictly a prerequisite, you will find detailed coverage of other features of DDMS in [the chapter on memory leak analysis using MAT](#) and [the chapter on measuring bandwidth consumption](#).

## Starting DDMS

As a reminder, to launch DDMS, you have two options:

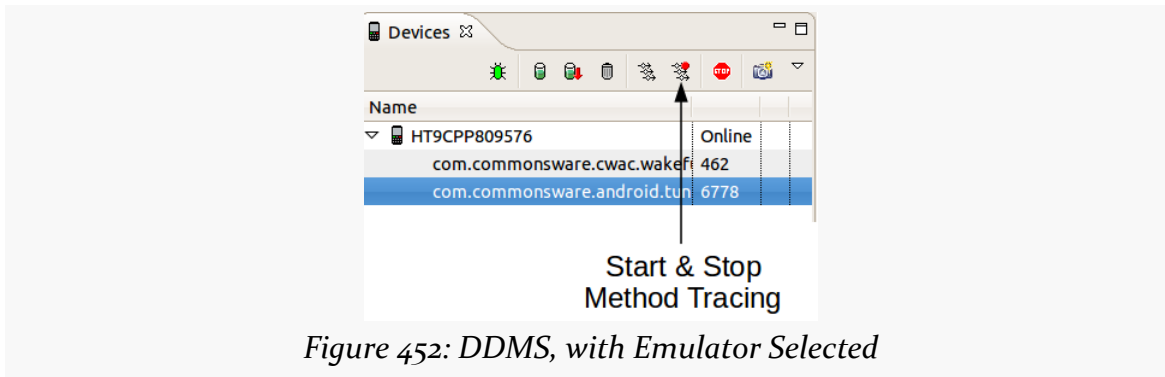
1. From Eclipse, choose the DDMS perspective
2. From the command line, run the `monitor` program to bring up the Android Device Monitor — the DDMS perspective should appear by default

---

## USING DDMS

---

DDMS will initially display a tree of emulators and devices and the running programs on each. Clicking on an emulator or device allows you to use the rest of the tools to work that that specific Android environment.



## File Push and Pull

The File Explorer view in DDMS allows you to upload and download files from your selected device or emulator. The view shows a typical file explorer-type tree of available folders and files on your selected device or emulator, which you can navigate as you would similar sorts of explorers you have no doubt seen elsewhere.

The toolbar above the view gives you three choices, once you have a folder or file selected:

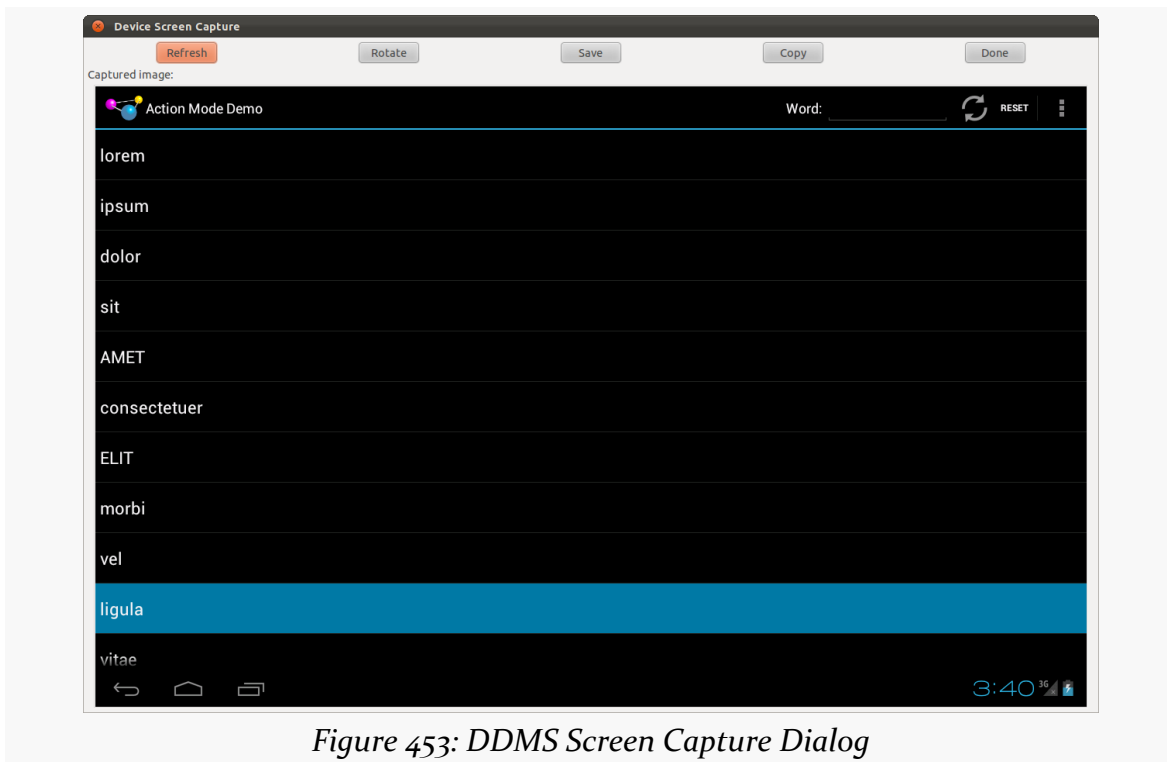
- Push a file to the device, either into a selected folder or to replace a selected file
- Pull a file from the device to your development machine
- Delete a selected file

There are a few caveats to this:

1. You cannot pull or delete a folder.
2. You cannot create directories through this tool. You will either need to use `adb shell` or create them from within your application.
3. While you can putter through most of the files on an emulator, you can access very little outside of `/mnt/sdcard` on an actual device, due to Android security restrictions.

## Screenshots

To take a screenshot of the Android emulator or device, click on the camera icon in the toolbar in the Devices view. This will bring up a dialog box containing an image of the current screen:



*Figure 453: DDMS Screen Capture Dialog*

From here, you can click “Save” to save the image as a PNG file somewhere on your development machine, “Refresh” to update the image based on the current state of the emulator or device, “Rotate” to change the orientation of the screenshot, or “Done” to close the dialog.

## Location Updates

To use DDMS to supply location updates to your application, the first thing you must do is have your application use the GPS LocationProvider, as that is the one that DDMS is set to update.



## USING DDMS

Then, in the Emulator Control view, you will see a Location Controls section. Here, you will find a smaller tabbed pane with three options for specifying locations: Manual, GPX, and KML:

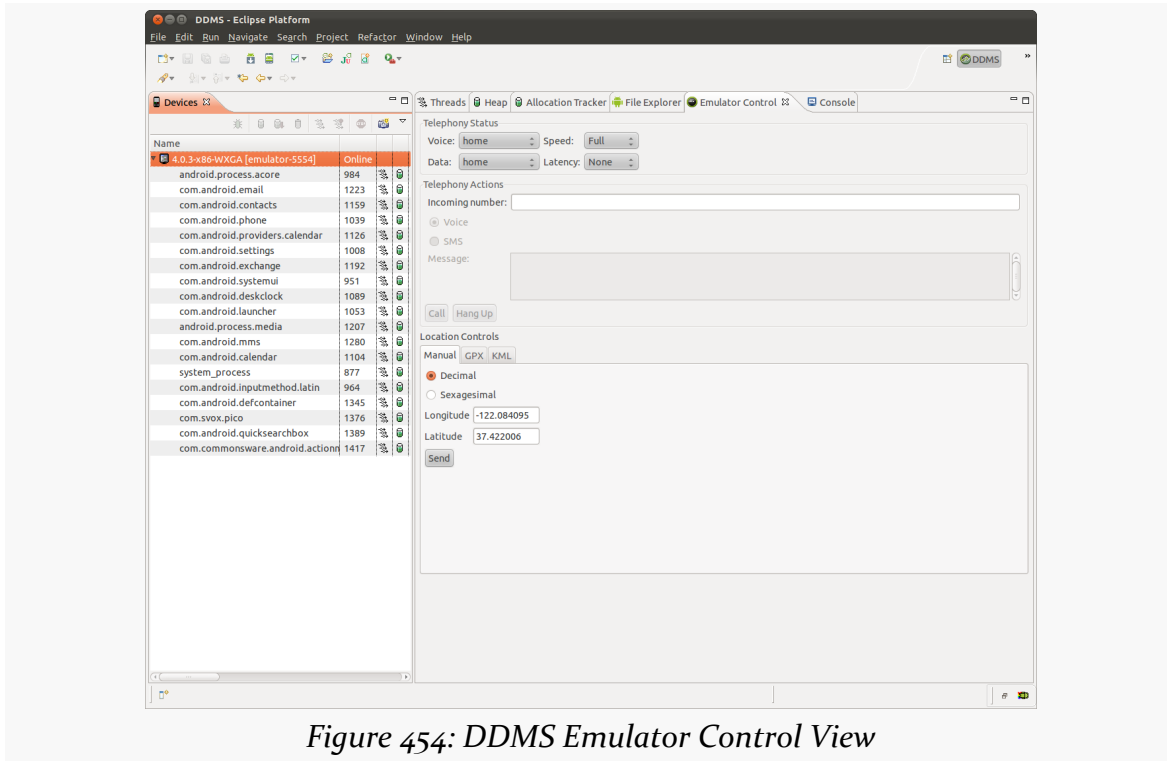


Figure 454: DDMS Emulator Control View

The Manual tab is fairly self-explanatory: provide a longitude and latitude, in decimal degrees, and click the Send button to submit that location to the emulator. The emulator, in turn will notify any location listeners of the new position. The fields are pre-populated with the longitude and latitude of a building on Ampitheater Parkway, in Mountain View, CA, USA.

Note that you cannot simulate GPS on a device this way, only on an emulator.

## Placing Calls and Messages

If you want to simulate incoming calls or SMS messages to the Android emulator, DDMS can handle that as well.

On the Emulator Control view, above the Location Controls group, is the Telephony Actions group.

## USING DDMS

---

To simulate an incoming call, fill in a phone number, choose the Voice radio button, and click Call. At that point, the emulator will show the incoming call, allowing you to accept it (via the green phone button) or reject it (via the red phone button):

To simulate in an incoming text message, fill in a phone number, choose the SMS radio button, enter a message in the provided text area, and click Send. The text message will then be delivered to the emulator as if it came in over the air.

Note that you cannot simulate SMSes on a device this way, only on an emulator. |



# Signing Your App

---

Perhaps the most important step in preparing your application for production distribution is signing it with a production signing key. While mistakes here may not be immediately apparent, they can have significant long-term impacts, particularly when it comes time for you to distribute an update.

## Prerequisites

Understanding this chapter requires that you have read the core chapters of this book.

## Role of Code Signing

There are many reasons why Android wants you to sign your application with a production key. Here are perhaps the top three:

- It will help distinguish your production applications from debug versions of the same applications
- Multiple applications signed with the same key can access each other's private files, if they are set up to use a shared user ID in their manifests
- You can only update an application if it has a signature from the same digital certificate

The latter one is the most important for you, if you plan on offering updates of your application. If you sign version 1.0 of your application with one key, and you sign version 2.0 of your application with another key, version 2.0 will not install over top version 1.0 — it will fail with a certificate-match error.

### What Happens In Debug Mode

Of course, you may be wondering how you got this far in life without worrying about keys and certificates and signatures (unless you are using Google Maps, in which case you experienced a bit of this when you got your API key).

The Android build process, whether through Ant or Eclipse, creates a debug key for you automatically. That key is automatically applied when you create a debug version of your application (e.g., `ant debug` or `ant install`). This all happens behind the scenes, so it is very possible for you to go through weeks and months of development and not encounter this problem.

In fact, the most likely place where you might encounter this problem is in a distributed development environment, such as an open source project. There, you might have encountered problem #3 from the previous section, where a debug application compiled by one team member cannot install over the debug application from another team member, since they do not share a common debug key. You may have run into similar problems just on your own if you use multiple development machines (e.g., a desktop in the home office and a notebook for when you are on the road delivering Android developer training).

So, developing in debug mode is easy. It is mostly when you move to production that things get a bit more interesting.

### Creating a Production Signing Key

To create a production signing key, you will need to use `keytool`. This comes with the Java SDK, and so it should be available to you already.

The `keytool` utility manages the contents of a “keystore”, which can contain one or more keys. Each “keystore” has a password for the store itself, and keys can also have their own individual passwords. You will need to supply these passwords later on when signing an application with the key.

Here is an example of running `keytool`:

```
mmurphy@opti755:~$ keytool -genkey -v -keystore cw-release.keystore -alias cw-re  
lease -keyalg RSA -validity 10000
```

*Figure 455: Running keytool*

## SIGNING YOUR APP

---

The parameters used here are:

1. `-genkey`, to indicate we want to create a new key
2. `-v`, to be verbose about the key creation process
3. `-keystore`, to indicate what keystore we are manipulating (`cw-release.keystore`), which will be created if it does not already exist
4. `-alias`, to indicate what human-readable name we want to give the key (`cw-release`)
5. `-keyalg`, to indicate what public-key encryption algorithm to be using for this key (RSA)
6. `-validity`, to indicate how long this key should be valid, where 10,000 days or more is recommended

The length of the validity is important. Once your key expires, you can no longer use it for signing new applications, which means once the key expires, you cannot update existing Android applications. 10,000 days, presumably, is beyond the expected lifespan of this signing mechanism. Also, the Play Store requires your key to be valid beyond October 22, 2033.

If you run the above command, you will be prompted for a number of pieces of information. If you have ever created an SSL certificate, the prompts will be familiar:

```
mmurphy@opti755:~$ keytool -genkey -v -keystore cw-release.keystore -alias cw-re
lease -keyalg RSA -validity 10000
Enter keystore password:
Re-enter new password:
What is your first and last name?
[Unknown]: Mark Murphy
What is the name of your organizational unit?
[Unknown]:
What is the name of your organization?
[Unknown]: CommonsWare, LLC
What is the name of your City or Locality?
[Unknown]:
What is the name of your State or Province?
[Unknown]: PA
What is the two-letter country code for this unit?
[Unknown]: US
Is CN=Mark Murphy, OU=Unknown, O="CommonsWare, LLC", L=Unknown, ST=PA, C=US corr
ect?
[no]: yes

Generating 1,024 bit RSA key pair and self-signed certificate (SHA1withRSA) with
a validity of 10,000 days
for: CN=Mark Murphy, OU=Unknown, O="CommonsWare, LLC", L=Unknown, ST=PA,
C=US
Enter key password for <cw-release>
(RETURN if same as keystore password):
Re-enter new password:
[Storing cw-release.keystore]
mmurphy@opti755:~$
```

*Figure 456: Results of running keytool*

---

## SIGNING YOUR APP

---

You will note that this is a self-signed certificate — you do not have to purchase a certificate from Verisign or anyone. These keys are for creating immutable identity, but are not for creating confirmed identity. In other words, these certificates do not prove you are such-and-so person, but can prove that the same key signed two different APKs.

In theory, you only need to do the above steps once per business.

### Signing with the Production Key

To sign an application with a production key, you must first create an unsigned version of the APK. By default (e.g., `ant debug`), you get an APK signed with the debug key. Instead, specifically build a release version (e.g., `ant release`), which should give you an `-unsigned.apk` file in your project's `bin/` directory.

Next, to apply the key, you will use the `jarsigner` tool. Like `keytool`, `jarsigner` comes with the Java SDK, and so you should already have it on your development machine.

Here is an example of running `jarsigner`:

```
mmurphy@opti755:~/stuff/CommonsWare/projects/vidtry$ jarsigner -verbose -keystore  
e ~/cw-release.keystore bin/vidtry-unsigned.apk cw-release
```

*Figure 457: Running jarsigner*

In this case, the parameters supplied are:

1. `-verbose`, to explain what is going on as the program runs
2. `-keystore`, to indicate where the keystore that contains the production key resides (`~/cw-release.keystore`)
3. the path to the APK to sign (`bin/vidtry-unsigned.apk`)
4. the alias of the key in the keystore to apply (`cw-release`)

At this point, `jarsigner` will prompt you for the keystore's password (and the key's password if you supplied a distinct password for it to `keytool`), then it will apply the signature:

## SIGNING YOUR APP

---

```
mmurphy@opti755:~/stuff/CommonsWare/projects/vidtry$ jarsigner -verbose -keystore
e ~/cw-release.keystore bin/vidtry-unsigned.apk cw-release
Enter Passphrase for keystore:
adding: META-INF/MANIFEST.MF
adding: META-INF/CW-RELEA.SF
adding: META-INF/CW-RELEA.RSA
signing: res/drawable/btn_media_player.9.png
signing: res/drawable/btn_media_player_disabled.9.png
signing: res/drawable/btn_media_player_disabled_selected.9.png
signing: res/drawable/btn_media_player_pressed.9.png
signing: res/drawable/btn_media_player_selected.9.png
signing: res/drawable/ic_media_pause.png
signing: res/drawable/ic_media_play.png
signing: res/drawable/media_button_background.xml
signing: res/layout/main.xml
signing: AndroidManifest.xml
signing: resources.arsc
signing: classes.dex
mmurphy@opti755:~/stuff/CommonsWare/projects/vidtry$
```

*Figure 458: Results of running jarsigner*

Next, you should test the signature by `jarsigner -verify -verbose -certs` on the same APK file, which now has a signature. You will get output akin to:

```
1090 Sat Aug 08 13:56:38 EDT 2009 META-INF/MANIFEST.MF
    1211 Sat Aug 08 13:56:38 EDT 2009 META-INF/CW-RELEA.SF
    946 Sat Aug 08 13:56:38 EDT 2009 META-INF/CW-RELEA.RSA
sm    1683 Sat Aug 08 13:54:46 EDT 2009
res/drawable/btn_media_player.9.png

    X.509, CN=Mark Murphy, OU=Unknown, O="CommonsWare, LLC",
L=Unknown, ST=PA, C=US
    [certificate is valid from 8/8/09 1:49 PM to 12/24/36 12:49 PM]

sm    743 Sat Aug 08 13:54:46 EDT 2009
res/drawable/btn_media_player_disabled.9.png

    X.509, CN=Mark Murphy, OU=Unknown, O="CommonsWare, LLC",
L=Unknown, ST=PA, C=US
    [certificate is valid from 8/8/09 1:49 PM to 12/24/36 12:49 PM]

sm    1030 Sat Aug 08 13:54:46 EDT 2009
res/drawable/btn_media_player_disabled_selected.9.png

    X.509, CN=Mark Murphy, OU=Unknown, O="CommonsWare, LLC",
L=Unknown, ST=PA, C=US
    [certificate is valid from 8/8/09 1:49 PM to 12/24/36 12:49 PM]

sm    1220 Sat Aug 08 13:54:46 EDT 2009
res/drawable/btn_media_player_pressed.9.png

    X.509, CN=Mark Murphy, OU=Unknown, O="CommonsWare, LLC",
L=Unknown, ST=PA, C=US
    [certificate is valid from 8/8/09 1:49 PM to 12/24/36 12:49 PM]

sm    1471 Sat Aug 08 13:54:46 EDT 2009
res/drawable/btn_media_player_selected.9.png
```



## SIGNING YOUR APP

---

X.509, CN=Mark Murphy, OU=Unknown, O="CommonsWare, LLC",  
L=Unknown, ST=PA, C=US  
[certificate is valid from 8/8/09 1:49 PM to 12/24/36 12:49 PM]

sm 576 Sat Aug 08 13:54:46 EDT 2009  
res/drawable/ic\_media\_pause.png

X.509, CN=Mark Murphy, OU=Unknown, O="CommonsWare, LLC",  
L=Unknown, ST=PA, C=US  
[certificate is valid from 8/8/09 1:49 PM to 12/24/36 12:49 PM]

sm 938 Sat Aug 08 13:54:46 EDT 2009  
res/drawable/ic\_media\_play.png

X.509, CN=Mark Murphy, OU=Unknown, O="CommonsWare, LLC",  
L=Unknown, ST=PA, C=US  
[certificate is valid from 8/8/09 1:49 PM to 12/24/36 12:49 PM]

sm 1176 Sat Aug 08 13:54:46 EDT 2009  
res/drawable/media\_button\_background.xml

X.509, CN=Mark Murphy, OU=Unknown, O="CommonsWare, LLC",  
L=Unknown, ST=PA, C=US  
[certificate is valid from 8/8/09 1:49 PM to 12/24/36 12:49 PM]

sm 2668 Sat Aug 08 13:54:46 EDT 2009 res/layout/main.xml

X.509, CN=Mark Murphy, OU=Unknown, O="CommonsWare, LLC",  
L=Unknown, ST=PA, C=US  
[certificate is valid from 8/8/09 1:49 PM to 12/24/36 12:49 PM]

sm 1368 Sat Aug 08 13:54:46 EDT 2009 AndroidManifest.xml

X.509, CN=Mark Murphy, OU=Unknown, O="CommonsWare, LLC",  
L=Unknown, ST=PA, C=US  
[certificate is valid from 8/8/09 1:49 PM to 12/24/36 12:49 PM]

sm 2888 Sat Aug 08 13:54:46 EDT 2009 resources.arsc

X.509, CN=Mark Murphy, OU=Unknown, O="CommonsWare, LLC",  
L=Unknown, ST=PA, C=US  
[certificate is valid from 8/8/09 1:49 PM to 12/24/36 12:49 PM]

sm 16860 Sat Aug 08 13:54:46 EDT 2009 classes.dex

X.509, CN=Mark Murphy, OU=Unknown, O="CommonsWare, LLC",  
L=Unknown, ST=PA, C=US  
[certificate is valid from 8/8/09 1:49 PM to 12/24/36 12:49 PM]

s = signature was verified  
m = entry is listed in manifest  
k = at least one certificate was found in keystore

---

## SIGNING YOUR APP

---

```
i = at least one certificate was found in identity scope
jar verified.
```

In particular, you want to make sure that the name of the key is what you expect and is not “Android Debug”, which would indicate the APK was signed with the debug key instead of the production key.

At this point, you should also rename the APK, at least to remove the now-erroneous -unsigned portion of the filename.

Now, you have a production-signed APK, ready for distribution... or, hopefully, ready for more testing, *then* distribution.

### Two Types of Key Security

There are two facets to securing your production key that you need to think about:

- You need to make sure nobody steals your production keystore and its password. If somebody does, they could publish replacement versions of your applications — since they are signed with the same key, Android will assume the replacements are legitimate.
- You need to make sure you do not lose your production keystore and its password. Otherwise, even *you* will be unable to publish replacement versions of your applications.

For solo developers, the latter scenario is more probable. There already have been cases where developers had to rebuild their development machine and wound up with new keys, locking themselves out from updating their own applications. As with everything involving computers, having a solid backup regimen is highly recommended.

For teams, the former scenario may be more likely. If more than one person needs to be able to sign the application, the production keystore will need to be shared, possibly even stored in the revision control system for the project. The more people who have access to the keystore, the more likely it is somebody will wind up doing something evil with it. This is particularly true for projects with public revision control systems, such as open source projects — developers might not think of the implications of putting the production keystore out for people to access.

### Related Keys

Switching from debug to production keys may have additional ramifications for your application.

For example, if you are integrating Google Maps, you no doubt obtained a Maps API key to use with your application. As it turns out, you most likely got an API that corresponds to your debug signing key. For production, you will need a different Maps API key, one that corresponds to your production signing key.

This will likely be a significant pain for you, because the Maps API key goes in the source code, meaning the source code is now dependent upon how it is being signed. You may wish to apply some automation to this, such as building custom Ant tasks that switches between debug and production Maps API keys in your source code depending on how you are building the project.

In principle, the same concept may extend to other keys for other Android development add-ons, though none are known at this time.

# Distribution

---

It is entirely possible that the user base for your app consists solely of yourself.

However, in most cases, you are going to be giving your app to others, free or for some sort of fee.

This chapter outlines things you will need to think about when distributing your app.

## Prerequisites

Understanding this chapter requires that you have read the core chapters of this book, particularly the chapter on [signing your app](#).

## Get Ready To Go To Market

While being able to sign your application reliably with a production key is necessary for publishing a production application, it is not sufficient. Particularly for the Play Store, there are other things you must do, or should do, as part of getting ready to release your application.

## Versioning

You need to supply `android:versionCode` and `android:versionName` attributes in your `<manifest>` element in your `AndroidManifest.xml` file. The value of `android:versionName` is what users and prospective users will see in terms of the label associated with your application version (e.g., “1.0.1”, “System V”, “Loquacious Llama”). More important, though, is the value of `android:versionCode`, which needs

to be an integer increasing with each release — that is how Android tells whether some edition of your APK is an upgrade over what the user currently has.

### Package Name

You also need to make sure that your package name — as denoted by the package attribute of the root `<manifest>` element — is going to be unique. If somebody tries downloading your application onto their device, and some other application is already installed with that same package name, your application will fail to install.

Since the manifest's package name also provides the base Java package for your project, and since you hopefully named your Java packages with something based off of a domain name you own or something else demonstrably unique, this should not cause a huge problem.

Also, bear in mind that your package name must be unique across all applications on the Play Store, should you choose to distribute that way.

### Icon and Label

Your `<application>` element needs to specify `android:icon` and `android:name` attributes, to supply the name and icon that will be associated with the application in the My Applications list on the device and related screens. Your activities will inherit the icon if they do not specify icons of their own.

If you have graphic design skills, the Android developer site has [guidelines](#) for creating icons that will match other icons in the system.

### Logging

In production, try to minimize unnecessary logging, particularly at low logging levels (e.g., debug). Remember that even if Android does not actually log the information, whatever processing is involved in making the `Log.d()` call will still be done, unless you arrange to skip the processing somehow. You could outright delete the extraneous logging calls, or wrap them in an `if()` test:

```
if (BuildConfig.DEBUG) {  
    Log.d(TAG, "This is what happened");  
}
```

## DISTRIBUTION

---

Here, `BuildConfig.DEBUG` is a `public static final boolean` value, supplied by Android, that indicates whether you are building for debug or production. Whether you adjust the definition by hand or by automating the build process is up to you. But, when `BuildConfig.DEBUG` is `false`, any work that would have been done to build up the actual `Log` invocation will be skipped, saving CPU cycles and battery life.

Conversely, error logs become even more important in production. Sometimes, you have difficult reproducing bugs “in the lab” and only encounter them on customer devices. Being able to get stack traces from those devices could make a major difference in your ability to get the bug fixed rapidly.

First, in addition to your regular exception handlers, consider catching everything those handlers miss, notably runtime exceptions:

```
Thread.setDefaultUncaughtExceptionHandler(onBlooeey);
```

This will route all uncaught exceptions to an `onBlooeey` handler:

```
private Thread.UncaughtExceptionHandler onBlooeey=  
    new Thread.UncaughtExceptionHandler() {  
        public void uncaughtException(Thread thread, Throwable ex) {  
            Log.e(TAG, "Uncaught exception", ex);  
        }  
    };
```

There, you can log it, raise a dialog if appropriate, etc.

Then, offer some means to get your logs off the device and to you, via email or a Web service. Some Android analytics firms, like [Flurry](#), offer exception stack trace collection as part of their service. There are also open source projects that support this feature, such as [ACRA](#).

## Testing

As always, testing, particularly acceptance testing, is important.

Bear in mind that the act of creating the production signed version of your application could introduce errors, such as having the wrong Google Maps API key. Hence, it is important to do user-level testing of your application after you sign, not just before you sign, in case the act of signing messed things up. After all, what you are shipping to those users is the production signed edition — you do not want your users tripping over obvious flaws.

## DISTRIBUTION

---

As you head towards production, also consider testing in as many distinct environments as possible, such as:

1. Trying more than one device, particularly if you can get devices with different display sizes
2. If you rely on the Internet, try your application with WiFi, with 3G, with EDGE/2G, and with the Internet unavailable
3. If you rely on GPS, try your application with GPS disabled, GPS enabled and working, and GPS enabled but not available (e.g., underground)

## EULA

End-user license agreements — EULAs — are those long bits of legal prose you are supposed to read and accept before using an application, Web site, or other protected item. Whether EULAs are enforceable in your jurisdiction is between you and your qualified legal counsel to determine.

In fact, many developers, particularly of free or open source applications, specifically elect not to put a EULA in their applications, considering them annoying, pointless, or otherwise bad.

However, the Play Store developer distribution agreement has one particular clause that might steer you towards having a EULA:

You agree that if you use the Market to distribute Products, you will protect the privacy and legal rights of users. If the users provide you with, or your Product accesses or uses, user names, passwords, or other login information or personal information, you must make the users aware that the information will be available to your Product, and you must provide legally adequate privacy notice and protection for those users... But if the user has opted into a separate agreement with you that allows you or your Product to store or use personal or sensitive information directly related to your Product (not including other products or applications) then the terms of that separate agreement will govern your use of such information.

Hence, if you are concerned about being bound by what Google thinks appropriate privacy is, you may wish to consider a EULA just to replace their terms with your own.

Unfortunately, having a EULA on a mobile device is particularly annoying to users, because EULAs tend to be long and screens tend to be short.

## DISTRIBUTION

---

Again, please seek professional legal assistance on issues regarding EULAs.





# Issues with Speed

---

Mobile devices are never fast enough. Either they are slow in general (e.g., slow CPU) or they are slow for particular operations (e.g., advanced game graphics).

What you do not want is for your application to be unnecessarily slow, where the user determines what is and is not “necessary”. Your opinion of what is “necessary”, alas, is of secondary importance.

This part of the book will focus on speed, including how you can measure and reduce lag in your applications. First, though, let’s take a look at some of the specific issues surrounding speed.

## Prerequisites

Understanding this chapter requires that you have read the core chapters and understand how Android apps are set up and operate.

## Getting Things Done

In some cases, you simply cannot seem to get the work done that you want to accomplish. Your database query seems slow. Your encryption algorithm seems slow. Your image processing logic seems slow. And so on.

The limits of the device will certainly make this more of a problem than it might otherwise be. Even a current-era dual-core device will be slow compared to your average notebook or desktop. Also, this sort of speed issue is pervasive throughout computing, with decades of experience to help developers learn how to write leaner code.

This part of the book will aim to help you identify where the problem spots are, so you know what needs optimization, and then some Android-specific techniques for trying to improve matters.

### Your UI Seems... Janky

Sometimes, the speed would be less of an issue for the user, if it was not freezing the UI or otherwise making it appear sluggish and “[janky](#)”.

The Android widget framework operates in a single-threaded mode. All UI changes — from setting the text of a `TextView` to handling scrolling of a `GridView` — are processed as events on an event queue by the main application thread. That same thread is used for most UI callbacks, including activity lifecycle methods (e.g., `onCreate()`) and UI event methods (e.g., `onClick()` of a `Button`, `getView()` of an `Adapter`). Any time you take in those methods on the main application thread tie up that thread, preventing it from processing other GUI events or dispatching user input. For example, if your `getView()` processing in an `Adapter` takes too long, scrolling a `ListView` may appear slow compared to other `ListView` widgets in other applications.

Your objective is to identify where things are slow and move them into background operations. Some of this has been advised since the early days of Android, such as moving all network I/O to background threads. Some of this has arisen more recently, such as the move to use the “loader” framework to help you get data from data stores in the background for populating your UI.

This part of the book will point out ways for you to find out where you may be doing unfortunate things on the main application thread and techniques for getting that work handled by a background thread, or possibly eliminated outright.

### Not Far Enough in the Background

Sometimes, even work you are trying to do in the background will seem to impact the foreground.

For example, you might think that your `Service` is automatically in the background. An `IntentService` does indeed use a background thread for processing commands via `onHandleIntent()`. However, all lifecycle methods of any `Service`, including `onStartCommand()`, are called on the main application thread. Hence, any time you take in those lifecycle methods will steal time away from GUI processing for the

main application thread. The same holds true for `onReceive()` of a `BroadcastReceiver` and all the main methods of a `ContentProvider` (e.g., `query()`).

Even your background threads may not be sufficiently in the background. A process runs with a certain priority, using Linux process management APIs, based upon its state (e.g., if there is an activity in the foreground, it runs at a higher priority than if the process solely hosts some service). This will help to cap the CPU utilization of the background work, but only to a point. Similarly, threads that you fork — directly or via something like `IntentService` — may run at default priority rather than a lower priority. Even with lower priorities for the thread or process, every CPU instruction executed in the background is one clock tick that cannot be utilized by the foreground.

This part of the book will help you identify where you are taking lots of time on various threads and will help you manually manage priorities to help minimize the foreground impact of those threads, in addition to helping you reduce the amount of work those threads have to do.

## Playing with Speed

Games, more so than most other applications, are highly speed-dependent. Everyone is seeking the “holy grail” of 60 frames per second (FPS) necessary for smooth animated effects. Not achieving that frame rate overall may mean the application will not appear quite as smooth; sporadically falling below that frame rate will result in jerky animation effects, much like the “janky” UIs in a non-game Android application.

For example, a classic problem with Android game development is garbage collection (GC). Only since the Gingerbread release of Android is the garbage collector concurrent, meaning that it runs in tandem with application code on a parallel thread. Historically, the Android garbage collector was a “stop the world” implementation, that would freeze the game long enough for a bit of GC work to be done before the game could continue. This behavior pretty much guaranteed sporadic failures to maintain a consistent frame rate. This caused game developers to have to take particular steps to avoid generating any garbage, such as maintaining its own object pools, to minimize or eliminate garbage collection pauses.

This book does not focus much on specific issues related to game development, though many of the techniques outlined here will be relevant for game developers.



# Finding CPU Bottlenecks

---

CPU issues tend to manifest themselves in three ways:

- The user has a bad experience when using your app directly — scrolling is sluggish, activities take too long to display, etc.
- The user has a bad experience when your app is running in the background, such as having slower frame rates on their favorite game because you are doing something complex in a service
- The user has poor battery performance, driven by your excessive CPU utilization

Regardless of how the issue appears to the user, in the end, it is a matter of you using too much CPU time. That could be simply because your application is written to be constantly active (e.g., you have an everlasting service that uses `TimerTask` to wake up every second and do something). There is little anyone can do to help that short of totally rethinking the app's architecture (e.g., switch to `AlarmManager` and allow the user to configure the polling period).

However, in many cases, the problem is that you are using algorithms – yours or ones built into Android — that simply take too long when used improperly. This chapter will help you identify these bottlenecks, so you know what portions of your code need to be optimized in general or apply the techniques described in later chapters of this part of the book.

## Prerequisites

Understanding this chapter requires that you have read the core chapters and understand how Android apps are set up and operate. Reading [the introductory chapter to this trail](#) is also a good idea.

# Traceview

The #1 tool in your toolbox for finding out where bottlenecks are occurring in your application is Traceview. This is available both within the Eclipse environment — though not as a separate perspective — and as a standalone tool.

## What Is Traceview?

Traceview is Android's take on a method profiler. Profilers have existed for most other platforms, in one form or fashion, dating back to the mainframe days.

Technically, the profiling in Android is performed by the Dalvik virtual machine, under the direction of either DDMS or requests from your application code. Dalvik will write the “trace data” (call graphs showing methods, what they call, and the amount of time in each) to a file on external storage of the device or emulator. Traceview then views these trace files in a GUI, allowing you to visualize “hot spots”, drill down to find where the time is being taken, and so forth.

At the time of this writing, Traceview is designed for use on single-core devices. Results on multi-core devices may be difficult to interpret.

## Collecting Trace Data

Hence, the first step for finding where your CPU bottlenecks lie comes in the form of collecting trace data, to analyze with Traceview. As mentioned, there are two approaches for requesting trace data be logged: using the Debug class, and using DDMS.

### Debug Class

If you know what chunk of code you want to profile, one way to arrange for the profile is to call `startMethodTracing()` on the Debug class. This takes the name of a trace file as a parameter and will begin recording all activity to that file, stored in the root of your external storage. You need to call `stopMethodTracing()` at some point to stop the trace — failing to do so will leave you with a corrupt trace file in the end.

Note that your application will need the `WRITE_EXTERNAL_STORAGE` permission for this to work. If your application does not normally need this permission, make yourself a note to remove it before you ship the production edition of your product, as there is no sense asking for any more permissions than you absolutely need. Also,

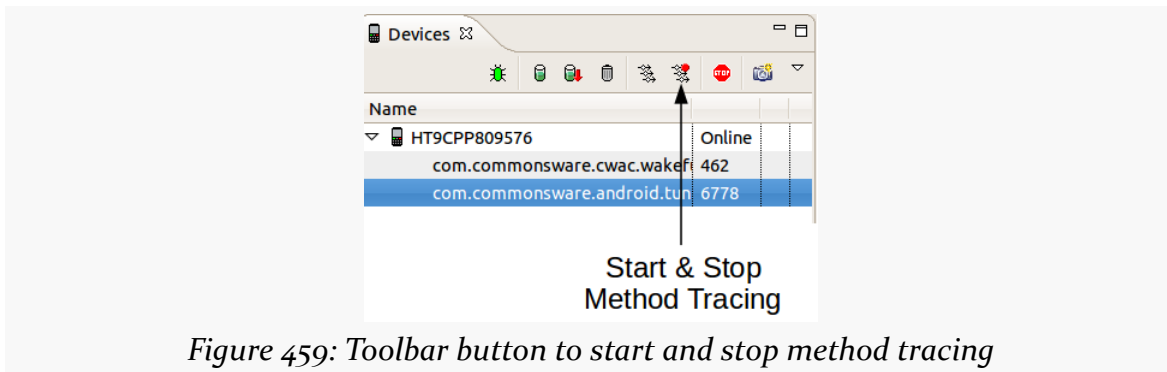
## FINDING CPU BOTTLENECKS

---

your device or emulator will need enough external storage to hold the file, which can get very large for long traces — 100MB a minute is well within reason.

### DDMS

Alternatively, you can initiate tracing via a toolbar button in DDMS. In both the DDMS perspective in Eclipse and the standalone DDMS, there is a button in the toolbar above the tree-table of devices and processes that toggles tracing on and off:



*Figure 459: Toolbar button to start and stop method tracing*

On Android 2.1 and earlier, this will write the trace out to a file on external storage, much as `startMethodTracing()` does. Hence, your application will need `WRITE_EXTERNAL_STORAGE` in this case, plus have enough external storage space to hold the file.

On Android 2.2 and newer, though, this data is written straight to the development machine, bypassing external storage. This means you do not need to worry about permissions or free space on your external storage. Hence, unless your problem only exists on Android 2.1 and earlier, you may find it easier to do your Traceview work on a newer Android device or emulator image. The file will wind up in your development machine's temporary directory (e.g., `/tmp` on Linux).

### Performance While Tracing

Writing out each method invocation to a trace file adds significant overhead to your application. Run times can easily double or more. Hence, absolute times while tracing is enabled are largely meaningless — instead, as you analyze the data in Traceview, the goal is to examine relative times (i.e., such-and-so method takes up X% of the CPU time shown in the trace).



## FINDING CPU BOTTLENECKS

Also, running Traceview disables the JIT engine in Dalvik, further harming performance. Notably, this will not affect any native code you have added via the NDK, so an application run in Traceview will give you unusual results (much worse Java performance, more normal native performance).

### Displaying Trace Data

Given that we have collected a trace file with data, the next step is to open up Traceview on that file. Depending on how you collected the file, Traceview may appear “automagically”, or it may require you to manually start it up and point it to the trace file.

### Eclipse/DDMS

If you used the DDMS perspective in Eclipse to record the trace data, the Debug perspective in Eclipse will automatically open up when you stop the tracing, showing you a Traceview tool:

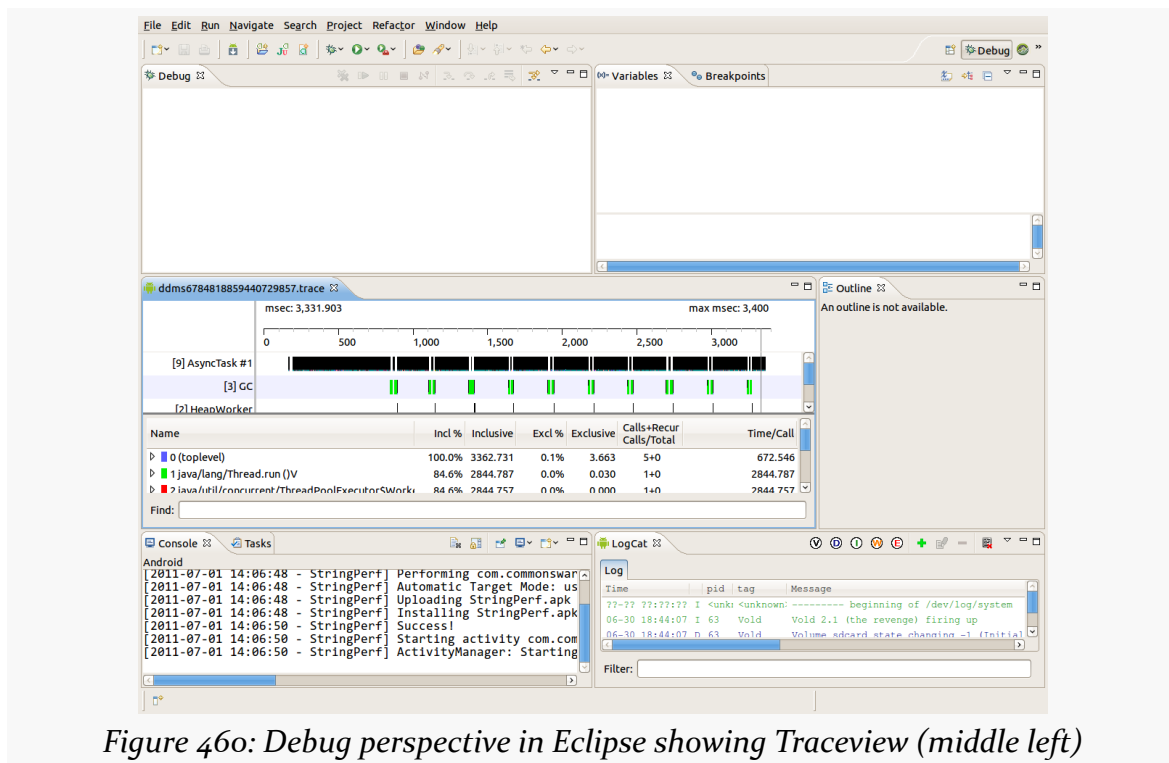


Figure 460: Debug perspective in Eclipse showing Traceview (middle left)

### Standalone Traceview

If you used standalone DDMS and run a trace on Android 2.2 and up, it will automatically launch in the standalone Traceview utility.

If your trace file wound up on external storage on your device or emulator, you will need to download it to your development machine, whether using the File Manager within DDMS, or via the `adb pull` command. Once on your development machine, you can view it in the standalone Traceview tool using the `traceview` command:

```
traceview <path-to-trace-file>
```

Or, you can import the file into your Eclipse project, then double-click on it in the Project Explorer to view it in the Traceview tool.

### Interpreting Trace Data

Of course, the challenge is in making sense of what Traceview is trying to present.

For example, a classic performance bug in Java development is using string concatenation:

```
package com.commonware.android.traceview;

import android.view.View;
import android.widget.TextView;

public class StringConcatActivity extends BaseActivity {
    StringConcatTask createTask(TextView msg, View v) {
        return(new StringConcatTask(msg, v));
    }

    class StringConcatTask extends BaseTask {
        StringConcatTask(TextView msg, View v) {
            super(msg, v);
        }

        protected String doTest() {
            String result="This is a string";

            result+=" -- that varies --";
            result+=" and also has ";
            result+=String.valueOf(4);
            result+=" hyphens in it";

            return(result);
        }
    }
}
```

## FINDING CPU BOTTLENECKS

```
}  
}  
}
```

Here is a Traceview screen showing that code executed 100,000 times, as packaged in a StringPerfConcat activity in the [Tuning/Traceview](#) sample project:

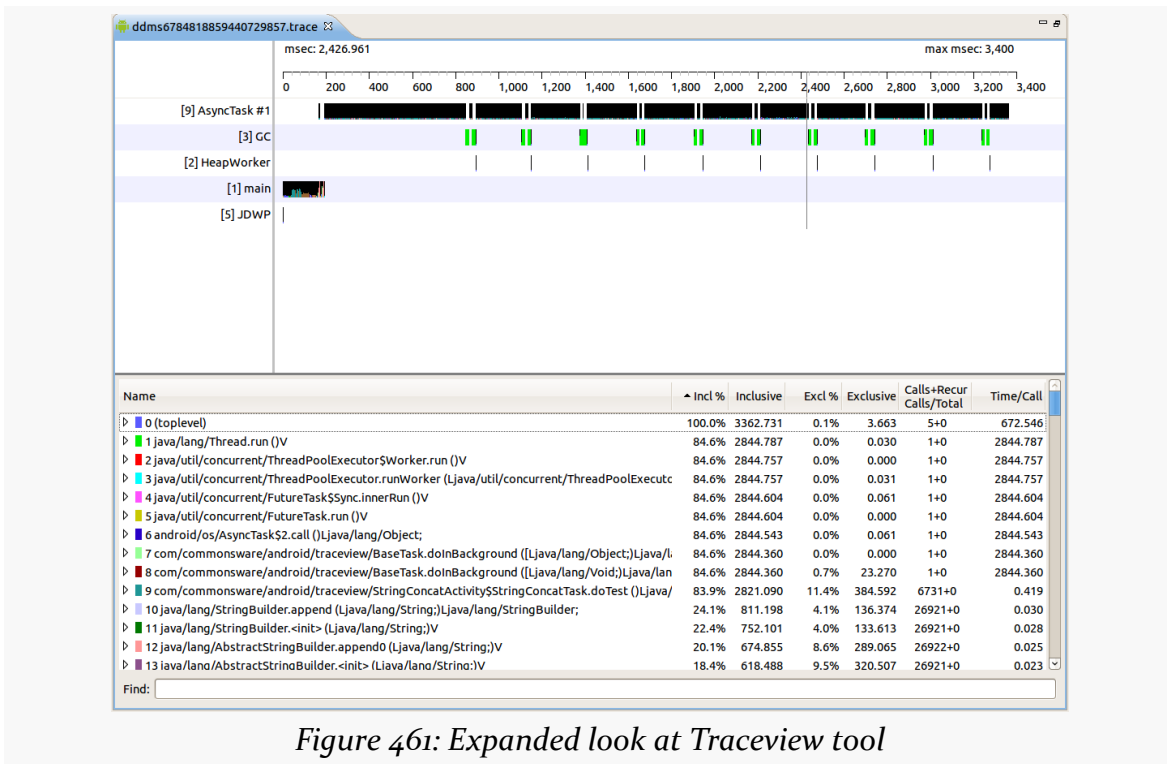


Figure 461: Expanded look at Traceview tool

The bars in the top portion of the display show different threads in the running application, in a timeline fashion, with time running from left to right. The “main” bar shows the main application thread, spending most of its time initializing the activity. The GC and HeapWorker threads are involved in garbage collection, popping in from time to time to collect garbage during 100,000 iterations of the above algorithm. Those 100,000 iterations are run in an AsyncTask, so we do not encounter an application-not-responding (ANR) dialog, and that is the “AsyncTask #1” thread at the top of the diagram.

## FINDING CPU BOTTLENECKS

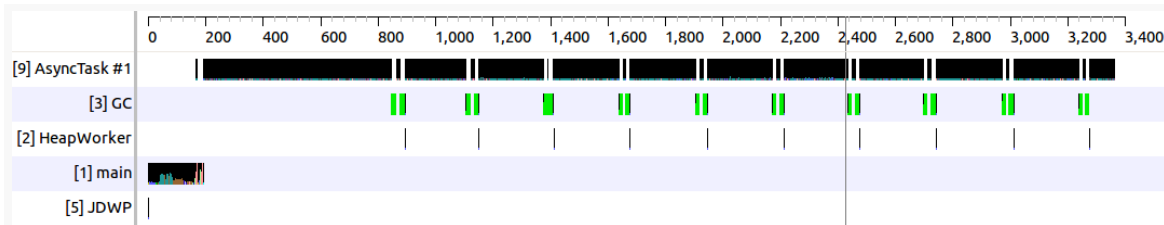


Figure 462: Zoomed in look at the TraceView thread timelines

You will notice that the horizontal timeline bars are not contiguous – there are gaps. In fact, if you were to combine all of the timelines into one, the “holes” in most of the rows would be filled by time in another row. This is illustrating that there is only one core on most Android device CPUs (these images were taken from a test run on a single-core Nexus One). We think of AsyncTask as moving work to the background, but it is important to remember that it still is consuming CPU time, even if the background thread means that we are not tying up the main application thread.

The bottom half of the display shows what methods are taking up all of the time, inclusively, in descending order. By “inclusively”, Traceview means “code executed in this method and any methods it invokes”. Hence, the top “100.0%” line shows the entry point to the whole application, and the next line shows where the AsyncTask’s background thread is being forked, and so on.

Typically, you want to find lines that reference your code. In this case, lines 7–9 are from the `com.commonware` package. Let’s focus on those:

7	com/commonware/android/traceview/BaseTask.doInBackground ((Ljava/lang/Object;)Ljava/l	84.6%	2844.360	0.0%	0.000	1+0	2844.360
8	com/commonware/android/traceview/BaseTask.doInBackground ((Ljava/lang/void;)Ljava/lan	84.6%	2844.360	0.7%	23.270	1+0	2844.360
9	com/commonware/android/traceview/StringConcatActivity\$StringConcatTask.doTest ()Ljava/	83.9%	2821.090	11.4%	384.592	6731+0	0.419

Figure 463: Sample application method calls in Traceview

On their own, these lines are not especially informative. However, if we fold open the bottom row, using the arrow indicator on the left, we can drill down into what is going on inside that particular method, which happens to be the algorithm shown earlier in this section:

## FINDING CPU BOTTLENECKS

Name	▲ Incl %	Inclusive	Excl %	Exclusive	Calls+Recur Calls/Total	Time/Call
8 com/commonsware/android/traceview/BaseTask.doinBackground ([Ljava/lang/Void;)Ljava/lang/	84.6%	2844.360	0.7%	23.270	1+0	2844.360
9 com/commonsware/android/traceview/StringConcatActivity\$stringConcatTask.doTest ()Ljava/	83.9%	2821.090	11.4%	384.592	6731+0	0.419
Parents						
Children						
self		13.6%		384.592		
10 java/lang/StringBuilder.append (Ljava/lang/String;)Ljava/lang/StringBuilder;		28.8%		811.167	26920/26921	
11 java/lang/StringBuilder.<init> (Ljava/lang/String;)V		26.7%		752.101	26921/26921	
14 java/lang/StringBuilder.toString ()Ljava/lang/String;		18.4%		520.177	26920/26921	
18 java/lang/String.valueOf (Ljava/lang/Object;)Ljava/lang/String;		7.5%		210.788	26921/26921	
22 java/lang/String.valueOf (I)Ljava/lang/String;		5.0%		142.051	6730/6730	
113 dalvik/system/VMDebug.startClassPrep (I)V		0.0%		0.214	2/25	

Figure 464: Drilling down in Traceview

The “self” line refers to code that is directly executed in the method, not involving a nested method call, such as variable declarations and returning values. We see the `valueOf()` calls, along with three rows showing references to `StringBuilder`. On the surface, that may seem odd, considering that we are not referring to `StringBuilder` in the source code.

It turns out that the `javac` compiler replaces string concatenation with `append()` calls on a `StringBuilder`, created on the fly for that specific concatenation. So, of the 83.9% of the time taken up in the entire run by the `doTest()` method, 26.7% is taken up by creating these temporary `StringBuilder` objects, 28.8% is consumed by calling `append()` on the `StringBuilder`, and another 18.4% is used by calling `toString()` to get the resulting `String` out of the `StringBuilder`.

This suggests an optimization: we could create our own `StringBuilder` and use it for concatenating the text, thereby saving us creating a few temporary ones and calling `toString()` extra times:

```
package com.commonsware.android.traceview;

import android.view.View;
import android.widget.TextView;

public class StringBuilderActivity extends BaseActivity {
    StringBuilderTask createTask(TextView msg, View v) {
        return(new StringBuilderTask(msg, v));
    }

    class StringBuilderTask extends BaseTask {
        StringBuilderTask(TextView msg, View v) {
            super(msg, v);
        }

        protected String doTest() {
            StringBuilder result=new StringBuilder("This is a string");
```

## FINDING CPU BOTTLENECKS

```
    result.append(" -- that varies --");
    result.append(" and also has ");
    result.append(String.valueOf(4));
    result.append(" hyphens in it");

    return(result.toString());
  }
}
```

This implementation of the algorithm runs about twice as fast as the first.

The “Exclusive” and “Excl %” columns show how much time is taken in an individual method itself, not including any children. If you sort on that, you see the specific local spots where time is being taken up. For example, here is a Traceview roster from testing the second algorithm shown above (the `StringPerfBuilder` activity):

Name	Incl %	Inclusive	▲ Excl %	Exclusive	Calls+Recur Calls/Total	Time/Call
▶ 11 java/lang/AbstractStringBuilder.append0 (Ljava/lang/String;)V	42.2%	1437.766	16.6%	564.832	48805+0	0.029
▶ 12 java/lang/String._getChars (II)C)V	15.7%	533.731	10.6%	360.757	61006+0	0.009
▶ 13 dalvik/system/VMDebug.startGC ()V	10.2%	347.656	10.2%	347.656	11+0	31.605
▶ 9 com/commonsware/android/traceview/StringBuilderActivity\$StringBuilderTask.doTest ()Ljava/	83.1%	2830.446	8.6%	291.807	12201+0	0.232
▶ 15 java/lang/AbstractStringBuilder.enlargeBuffer ()V	10.1%	342.959	7.7%	263.821	24401+0	0.014
▶ 18 java/lang/System.arraycopy (Ljava/lang/Object;ILjava/lang/Object;II)V	7.4%	252.688	7.4%	252.688	85509+0	0.003
▶ 10 java/lang/StringBuilder.append (Ljava/lang/String;)Ljava/lang/StringBuilder;	49.5%	1685.716	7.3%	247.981	48804+0	0.035
▶ 16 java/lang/AbstractStringBuilder.<init> (Ljava/lang/String;)V	8.4%	285.216	4.3%	147.095	12201+0	0.023
▶ 24 java/lang/String.length ()I	3.9%	134.395	3.9%	134.395	61018+0	0.002
▶ 21 java/lang/AbstractStringBuilder.toString ()Ljava/lang/String;	5.1%	174.300	3.8%	129.444	12201+0	0.014
▶ 32 java/lang/IntegralToString.convertInt (Ljava/lang/AbstractStringBuilder;I)Ljava/lang/String;	2.0%	69.758	2.0%	69.727	12202+0	0.006
▶ 23 java/lang/IntegralToString.intToString ()Ljava/lang/String;	4.0%	137.850	2.0%	68.123	12201+0	0.011
▶ 17 java/lang/String.valueOf ()Ljava/lang/String;	7.9%	267.410	2.0%	66.429	12201+0	0.022
▶ 19 java/lang/StringBuilder.toString ()Ljava/lang/String;	7.1%	240.708	2.0%	66.408	12201+0	0.020

*Figure 465: Traceview, sorted by exclusive time*

We see that the top three culprits are all Android/Dalvik methods, which we cannot optimize. Instead, the fact that they are taking up so much time is indicative of the fact that we are calling them a lot, also in evidence by the `Calls/Total` column. You can examine the parents of a call to see where those calls come from, to see if you can change upstream code to result in fewer such calls:

## FINDING CPU BOTTLENECKS

Name	Incl %	Inclusive	Excl %	Exclusive	Calls+Recur Calls/Total	Time/Call
11 java/lang/AbstractStringBuilder.append0 (Ljava/lang/String;)V	42.2%	1437.766	16.6%	564.832	48805+0	0.029
Parents						
10 java/lang/StringBuilder.append (Ljava/lang/String;)Ljava/lang/StringBuilder;	100.0%	1437.735			48804/48805	
32 java/lang/IntegralToString.convertInt (Ljava/lang/AbstractStringBuilder;)Ljava/lang/Strii	0.0%	0.031			1/48805	
Children						

Figure 466: Traceview, showing parents of a method call

Here, we can see that all those `append0()` calls are triggered by calls to `append()` on the `StringBuilder`, which is not terribly surprising.

You can also zoom in to take a very narrow look at the data. Simply click-drag a bar in the timeline to select a region to zoom into. The timeline will switch to show just that range of milliseconds and the calls that take place there:

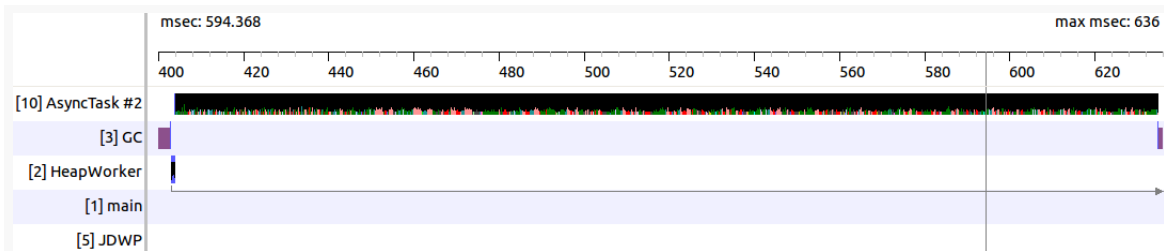
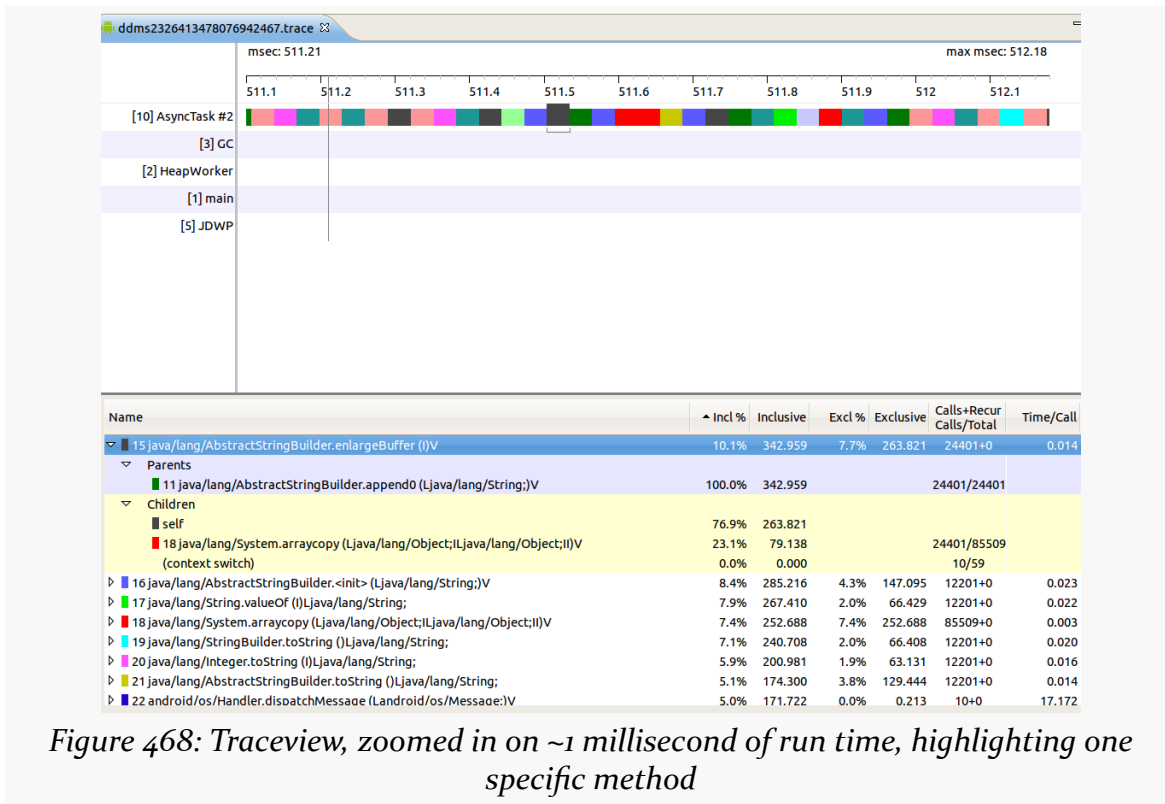


Figure 467: Traceview, zoomed in on ~230 milliseconds of run time

If you zoom in far enough, you will start seeing solid blocks of color, corresponding to the color-coded methods in the table of results on the bottom half of the screen. You can tap on any block of color to bring up that specific method in the table:

## FINDING CPU BOTTLENECKS



Zooming back out, though, is somewhat of a pain. If you drag the timeline itself (not one of the bars, but the “meter stick” showing the milliseconds) from left to right, you will zoom out. Do this enough times, and you can return approximately to the original state.

## Other General CPU Measurement Techniques

While Traceview is great for narrowing down a general performance issue to a specific portion of code, it does assume that you know approximately where the problem is, or that you even have a problem in the first place. There are other approaches to help you identify if and (roughly) where you have problems, which you can then attack with Traceview to try to refine.

### Logging

Traceview can be useful, if you have a rough idea of where your performance problem lies and need to narrow it down further. If you have a large and complicated application, though, trying to sift through all of it in Traceview may be difficult.



## FINDING CPU BOTTLENECKS

---

However, there is nothing stopping you from using good old-fashioned logging to get a rough idea of where your problems lie, for further analysis via Traceview. Just sprinkle your code with `Log.d()` calls, logging `SystemClock.uptimeMillis()` with an appropriate label to identify where you were at that moment in time. “Eyeballing” the LogCat output can illustrate areas where unexpected delays are occurring — the areas in which you can focus more time using Traceview.

A useful utility class for this is `TimingLogger`, in the `android.util` package. It will collect a series of “splits” and can dump them to LogCat along with the overall time between the creation of the `TimingLogger` object and the corresponding `dumpToLog()` method call. Note, though, that this will only log to LogCat when you call `dumpToLog()` — all of the calls to `split()` to record intermediate times have their results buffered until `dumpToLog()` is called. Also note that logging needs to be set to `VERBOSE` for this information to actually be logged — use the command `adb shell setprop log.tag.LOG_TAG VERBOSE`, substituting your log tag (supplied to the `TimingLogger` constructor) for `LOG_TAG`.

### FPS Calculations

Sometimes, it may not even be strictly obvious how bad the problem is. For example, consider scrolling a `ListView`. Some performance issues, like sporadic “hiccups” in the scrolling, will be visually apparent. However, absent those, it may be difficult to determine whether your particular `ListView` is behaving more slowly than you would expect.

A classic measurement for games is frames per second (FPS). Game developers aim for a high FPS value — 60 FPS is considered to be fairly smooth, for example. However, this sort of calculation can only really be done for applications that are continuously drawing — such as [Romain Guy’s WindowBackground sample application](#). Ordinary Android widget-based UIs are only drawing based upon user interaction or, possibly, upon background updates to data. In other words, if the UI will not even be trying to draw 60 times in a second, trying to measure FPS to get 60 FPS is pointless.

You may be able to achieve similar results, though, simply by logging how long it takes to, say, fling a list (use `setOnScrollListener()` and watch for `SCROLL_STATE_FLING` and other events).

# UI “Jank” Measurement

A user interface is considered “janky” if it stutters or otherwise fails to operate smoothly, particularly during animated effects like scrolling. Sometimes, janky behavior is obvious to all. Sometimes, janky behavior is only noticeable to those sensitive to small hiccups in the UI.

This section will outline what “jank” is and how to determine, concretely, if your UI suffers from it.

## What, Exactly, is Jank?

Prior to Android 4.0, it was difficult to come up with a concrete definition of jank. In effect, we were stuck with [“I know it when I see it”](#) ad-hoc analysis, rather than being able to rely on concrete measurements.

Project Butter changed that.

Android 4.0 ties all graphic operations to a 60 frames-per-second “vsync” frequency. If everything is working smoothly, your UI will update 60 times per second, uniformly (versus varying amounts of times between changes).

The converse is also true: if everything is not working smoothly, your UI will not update 60 times per second. This is the source of the term “dropped frames”: when the time came around for an update, you were not ready, and that frame was skipped.

There are two main ways in which you will drop a frame:

1. You spend too much time on the main application thread, preventing Android from processing your requested UI updates in a timely fashion
2. Your UI changes are too complex to be rendered before time runs out for the current frame, causing your changes to spill over into the next frame

Each frame is ~16ms in duration on-screen (1/60th of a second). Hence, if we cause per-frame work to exceed 16ms, we will skip, or “drop”, a frame.

So, what we need is some way to determine if our code is actually delivering frames on time.

### Using gfxinfo

To determine if our problem is in the actual rendering of our UI updates, we can use the GPU profiling feature added in Android 4.2.

### Enabling Developer Options

To toggle on GPU profiling, you will need to be able to get to the Developer Options portion of your Settings app. If you see this — typically towards the bottom of the list on the initial Settings screen — just tap on the entry.

If, however, Developer Options is missing, then you will need to use the super-secret trick for enabling Developer Options:

1. Tap on “About Phone”, “About Tablet”, or the equivalent at the bottom of your Settings list
2. Tap on the “Build Number” entry seven times in succession
3. Press BACK, and “Developer Options” should now be in the list

### Toggling on GPU Profiling

There are two checkboxes in Developer Options that need to be checked for GPU profiling to be enabled.

The first is “Force GPU rendering”, in the Drawing section. As the name suggests, this will force your application to use the GPU for drawing, even if your application may have requested that hardware acceleration be disabled. Since most applications do not force hardware acceleration to be disabled, this checkbox probably will have no real effect on your app. Note that if you disabled hardware acceleration due to specific rendering problems, this checkbox will probably cause those rendering artifacts to re-appear during your testing.

The second is “Profile GPU rendering”, in the Monitoring section. This will cause the device to keep track of graphics performance on a per-process basis, in a way that we can dump later on.

## FINDING CPU BOTTLENECKS

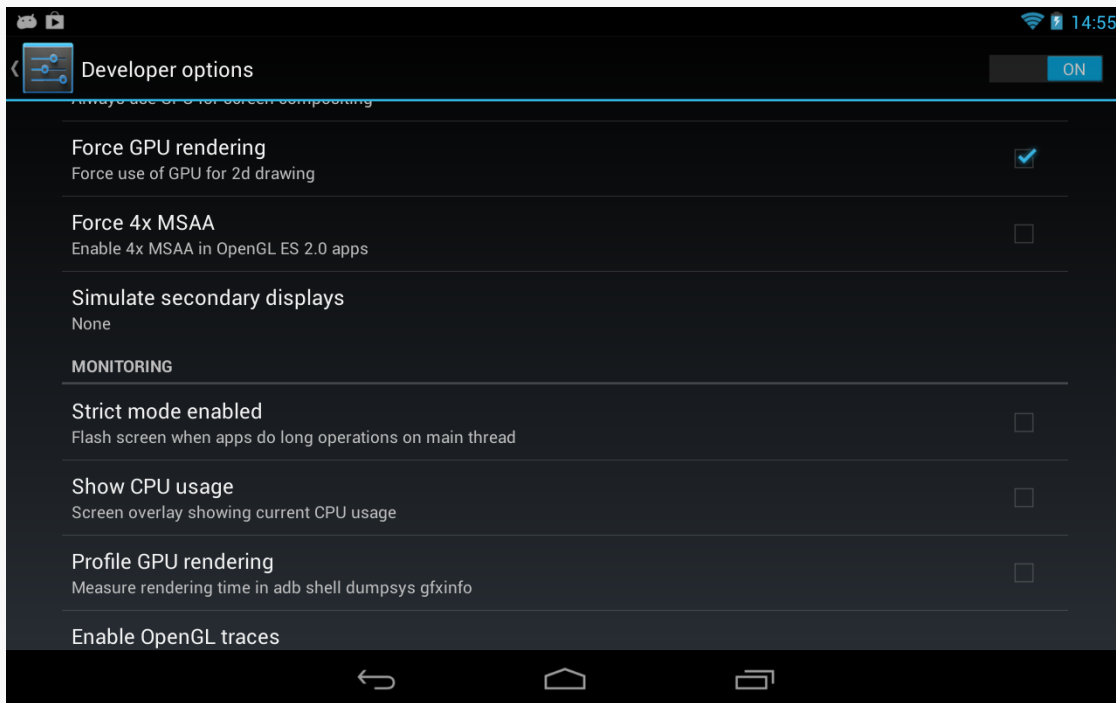


Figure 469: Developer Options, Showing “Force GPU rendering” and “Profile GPU rendering”

If your app was already running, you will need to get rid of its process (e.g., via swiping it off the recent-tasks list) after you check the “Profile GPU rendering” checkbox. At the present time, whether or not this profiling takes effect is determined at process startup time and is not changed on the fly when you toggle the checkbox. Besides, as noted above, starting with a fresh process should give you more accurate results.

### Collecting Data

At this point, you can run your app and conduct your specific test, whether manually or via instrumentation (e.g., a targeted [JUnit test suite](#)).

When complete, run `adb shell dumpsys gfxinfo ...` in a terminal window, where ... is replaced by the package name of your app (e.g., `com.commonware.android.anim.threepane`). This will dump a fair amount of information to the terminal display:

```
mmurphy@xps15:~$ adb shell dumpsys gfxinfo
com.commonware.android.anim.threepane
```

## FINDING CPU BOTTLENECKS

---

Applications Graphics Acceleration Info:  
Uptime: 482460 Realtime: 482454

\*\* Graphics info for pid 3469 [com.commonware.android.anim.threepane] \*\*

Recent DisplayList operations  
Save  
ClipRect  
Translate  
DrawText  
RestoreToCount  
DrawDisplayList  
Save  
ClipRect  
Translate  
DrawText  
RestoreToCount  
DrawDisplayList  
DrawPatch  
Save  
ClipRect  
Translate  
DrawText  
RestoreToCount  
DrawDisplayList  
Save  
ClipRect  
Translate  
DrawText  
RestoreToCount  
DrawDisplayList  
Save  
ClipRect  
Translate  
DrawText  
RestoreToCount  
DrawDisplayList  
Save  
ClipRect  
Translate  
DrawText  
RestoreToCount  
DrawDisplayList  
Save  
ClipRect  
Translate  
DrawText  
RestoreToCount  
DrawDisplayList  
Save  
ClipRect  
Translate  
DrawText  
RestoreToCount

## FINDING CPU BOTTLENECKS

```
DrawPatch
RestoreToCount
```

Caches:

Current memory usage / total memory usage (bytes):

```
TextureCache      1078032 / 25165824
LayerCache        7864320 / 16777216
GradientCache     0 / 524288
PathCache         0 / 4194304
CircleShapeCache  0 / 1048576
OvalShapeCache    0 / 1048576
RoundRectShapeCache 0 / 1048576
RectShapeCache    0 / 1048576
ArcShapeCache     0 / 1048576
TextDropShadowCache 0 / 2097152
FontRenderer 0    262144 / 262144
```

Other:

```
FboCache          3 / 16
PatchCache        89 / 512
```

Total memory usage:

9204496 bytes, 8.78 MB

Profile data in ms:

```
com.commonware.android.anim.threepane/
com.commonware.android.anim.threepane.MainActivity/
android.view.ViewRootImpl@4131e788
Draw Process Execute
14.45 59.67 10.44
10.91 1.06 1.20
1.73 12.80 1.19
1.45 0.64 0.94
2.15 0.47 0.57
0.79 0.50 0.60
2.23 0.49 0.73
1.56 0.57 0.52
6.14 0.47 1.92
0.84 0.53 0.59
1.58 0.52 0.60
1.46 0.55 0.54
1.74 0.75 0.68
1.74 0.61 0.61
1.05 0.62 1.00
1.05 0.71 1.28
1.29 0.50 0.56
2.22 0.60 0.75
0.90 0.65 1.42
1.70 0.86 0.61
0.81 1.07 0.93
6.66 2.35 0.98
0.93 5.18 0.73
0.34 1.24 0.51
0.45 1.28 0.46
1.85 4.38 1.45
```

## FINDING CPU BOTTLENECKS

---

1.32	3.15	1.03
1.50	3.16	0.98
1.42	3.00	1.00
0.90	2.94	1.00
0.69	2.36	1.15
1.08	2.72	0.86
1.49	4.22	1.49
0.97	2.91	0.91
0.89	3.05	0.90
1.36	3.02	1.07
1.12	2.95	0.95
1.63	3.47	1.02
0.96	2.95	0.98
2.75	5.55	1.83
2.11	1.47	0.51
0.44	1.50	0.48
0.67	1.46	0.51
2.07	3.93	3.13
0.71	4.36	1.93
1.75	3.31	1.15
2.39	1.79	1.02
0.96	1.71	0.81
0.57	1.70	0.73
1.88	1.81	0.58
0.59	1.72	0.55
2.28	3.74	1.72
2.66	0.84	0.70
0.64	0.82	0.64
0.30	0.80	0.62
1.78	0.70	0.63
7.20	2.35	1.04
0.49	0.21	0.50
9.99	0.26	0.54
4.28	0.23	0.66
0.04	0.26	1.94
3.55	0.52	0.66
4.56	0.59	0.62
5.38	0.33	0.68
4.44	0.33	0.65
4.35	0.30	0.73
3.76	0.27	0.60
3.72	0.30	0.64
3.75	0.26	0.58
4.79	0.33	0.75
4.68	0.33	0.85
3.00	0.22	0.53
2.44	0.26	0.83
14.87	0.69	1.59
8.68	0.96	1.96
3.44	0.47	0.96
3.73	0.22	0.65
3.06	0.72	0.65
3.86	0.35	1.13
3.32	0.26	0.57

## FINDING CPU BOTTLENECKS

---

```
3.21 0.26 0.62
3.84 0.26 0.60
4.85 0.33 0.72
4.16 0.32 0.70
3.96 0.30 0.69
2.60 0.82 0.66
8.72 0.47 0.69
0.49 0.31 1.50
0.46 0.28 0.77
7.54 3.66 0.90
7.50 0.27 0.71
0.06 0.32 2.37
6.07 0.28 0.97
3.68 0.27 0.52
6.39 5.86 4.48
4.66 0.29 1.28
0.05 0.26 11.86
8.87 12.64 1.25
3.32 0.26 0.58
6.22 4.77 1.26
3.49 0.31 0.86
11.32 10.49 1.26
10.27 15.09 1.78
12.50 1.34 2.53
7.66 4.74 0.58
0.03 0.24 0.32
4.43 0.30 0.56
9.75 2.94 1.68
17.93 0.47 0.56
3.81 0.35 1.04
0.20 2.84 2.72
10.06 0.28 0.92
5.74 0.72 1.92
0.07 0.87 0.53
2.05 0.95 2.03
```

View hierarchy:

```
com.commonware.android.anim.threepane/
com.commonware.android.anim.threepane.MainActivity/
android.view.ViewRootImpl@4131e788
  50 views, 4.48 kB of display lists, 115 frames rendered
```

```
Total ViewRootImpl: 1
Total Views:          50
Total DisplayList:   4.48 kB
```

We will discuss what this means in just a bit.



### Disabling GPU Profiling

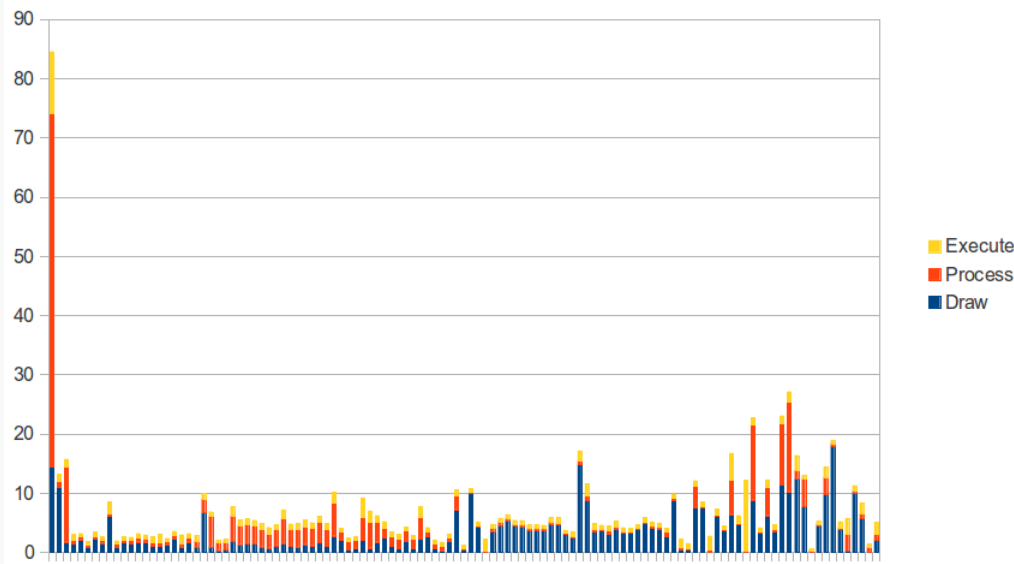
When you are done with your test, it is a good idea to undo the settings changes you made, at least “Profile GPU rendering”. That way, the act of collecting this data does not itself add overhead to unrelated tests in the future.

### Analyzing the Results

The key bit for our performance analysis is that long table labeled “Profile data in ms:”. This reports, for a series of UI requests, how much time is spent:

- drawing your UI changes (e.g., `onDraw()` calls to various widgets and containers)
- processing the low-level drawing commands created via the draw phase, to create the contents of the frame
- executing the frame, sending it to the compositor to display on the screen

One way to interpret this table is to paste it into your favorite spreadsheet program, then use that program to draw a stacked column chart of the data. You can [download a spreadsheet](#) in ODS format (for use with LibreOffice, OpenOffice, or other tools that can handle that format) that contains the above table along with a stacked column chart:



*Figure 470: gfxinfo Output, In Stacked Column Chart*

## FINDING CPU BOTTLENECKS

---

What you are looking for are columns that come close to, or exceed, the 16ms mark, with milliseconds on the Y axis. As you can see, many operations towards the end of the table are near or above 16ms, indicating that we are probably dropping some frames.

### Using systrace

Another way we could determine whether or not we are dropping frames is to use systrace to collect system-level tracing information about the entire device, including our app.

systrace is a very powerful tool, one that 20 or 30 people on the planet truly understand, due to cryptic output and limited documentation. Using gfxinfo for detecting dropped frames is simple by comparison. On the other hand, systrace works for Android 4.1 and higher, versus the Android 4.2 requirement of gfxinfo.

Using systrace involves collecting a trace, which is saved in the form of an HTML file. The HTML file is then used to determine what went on during the period of the trace itself.

### Enabling and Collecting a Trace: Command-Line

The original means of using systrace was from the command line. There is a systrace.py Python script located in the `tools/systrace/` directory of your SDK installation. If you have a Python interpreter (e.g., your development machine does not run Windows), you can use this approach.

To indicate what specific bits of information to collect, on Android 4.2 and higher, you can tap the “Enable traces” entry in the Monitoring section of the Developer Options page in Settings. This displays a multi-select dialog of the possible major categories of information that systrace should collect:

## FINDING CPU BOTTLENECKS

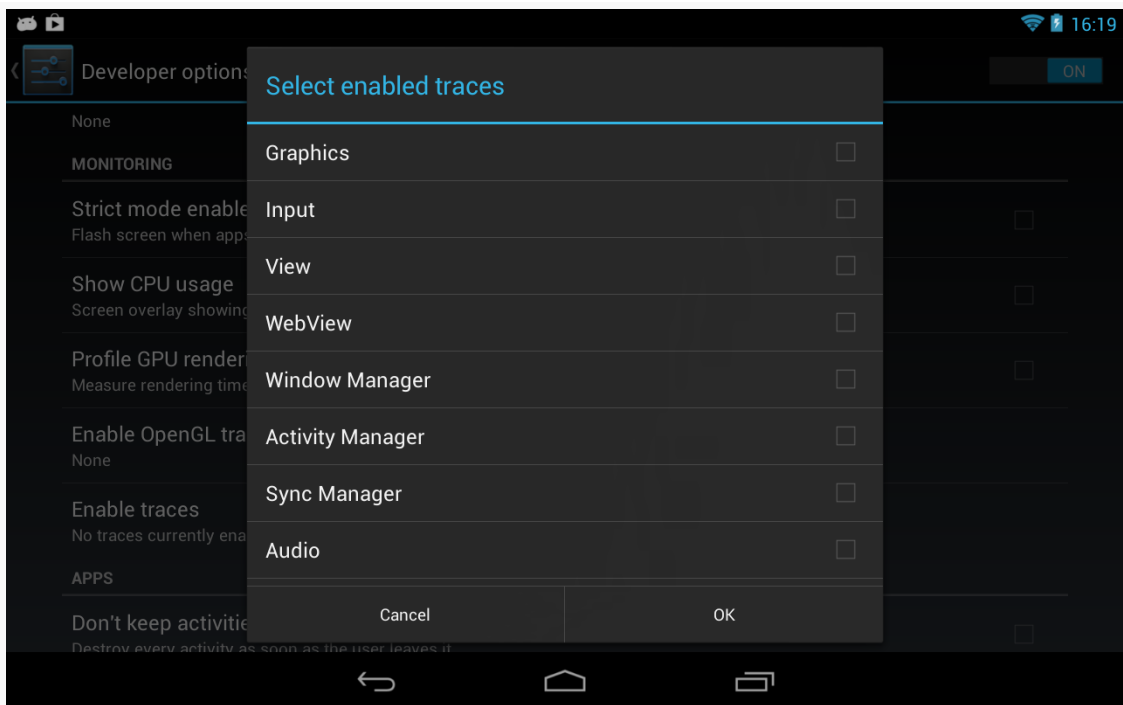


Figure 471: “Enable traces” In Settings

Alternatively, when you run the `systrace.py` script, you can include the `--set-tags` switch, with a comma-delimited list of specific traces (“tags”) that you want to collect. The list of available tag names can be found in [the developer documentation](#).

For detecting “jank”, you will want the Graphics and View traces enabled, which equates to `--set-tags gfx,view`.

To actually collect the trace, you run the `systrace.py` script, optionally with `--set-tags` or other command-line switches:

```
python systrace.py --set-tags gfx,view
```

By default, this will collect trace data for five seconds. While that seems short, bear in mind that this will result in a large HTML file (a few MB). You can use the `-t` switch to specify a different time period in seconds, if you wish.

The resulting HTML file will be written as `trace.html` in the current working directory, or in whatever location you specify using the `-o` switch.

---

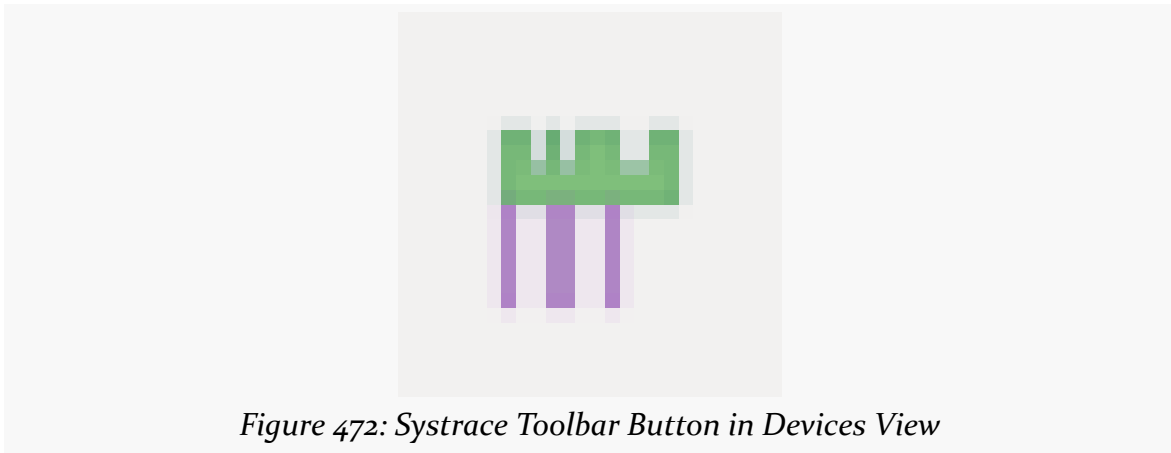
## FINDING CPU BOTTLENECKS

---

Once you run the script, quickly go to your device and run your test scenario, as the trace starts immediately upon running the script.

### Enabling and Collecting a Trace: Eclipse

The current version of the ADT plugin for Eclipse also allows you to collect a trace using `systrace`. There is a “Capture system wide trace using `systrace`” button in the toolbar in the Devices view, typically found in the DDMS perspective:



Tapping that toolbar button brings up a dialog that allows you to configure the trace you wish to collect, with checkboxes and fields replacing the variety of command-line switches you might use manually with `systrace.py`:

## FINDING CPU BOTTLENECKS

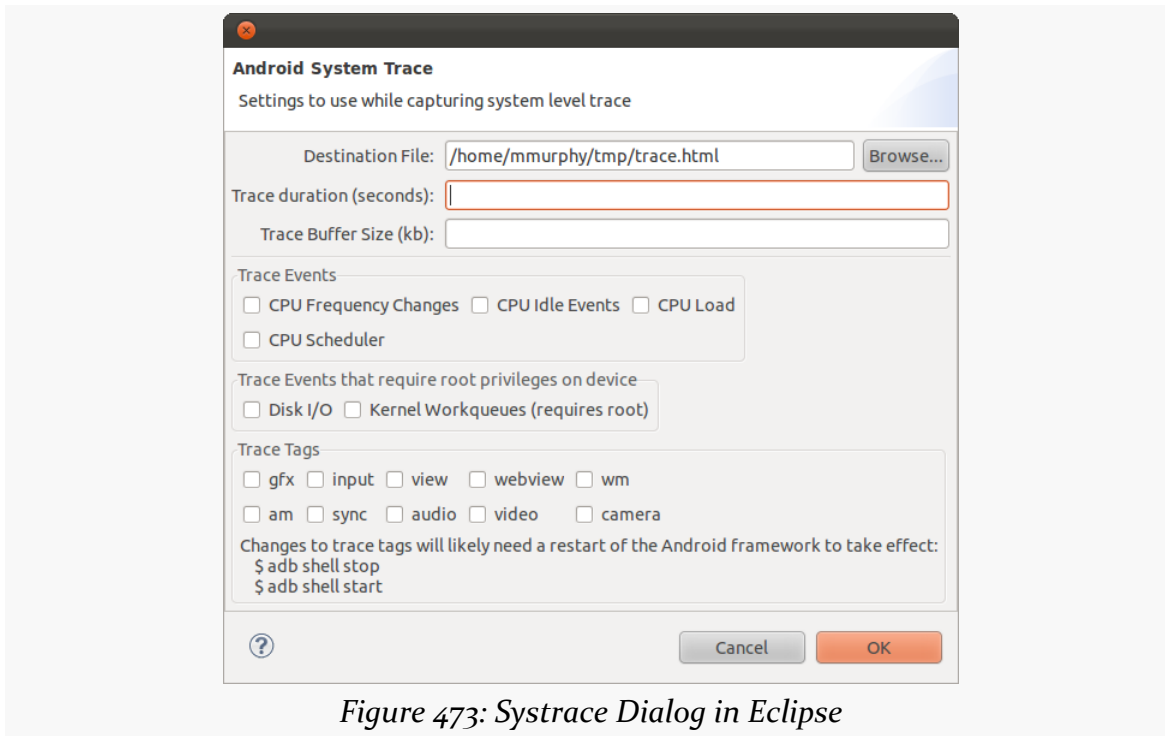


Figure 473: Systrace Dialog in Eclipse

Notable settings that you will wish to tailor include:

- Where the trace will be written (by default, as `trace.html` in your home or user directory)
- The duration of the trace (by default, 10 seconds, as opposed to 5 seconds for running `systrace.py` from the command line)
- Which trace tags you wish to use — for detecting jank, you want the `gfx` and `view` tags

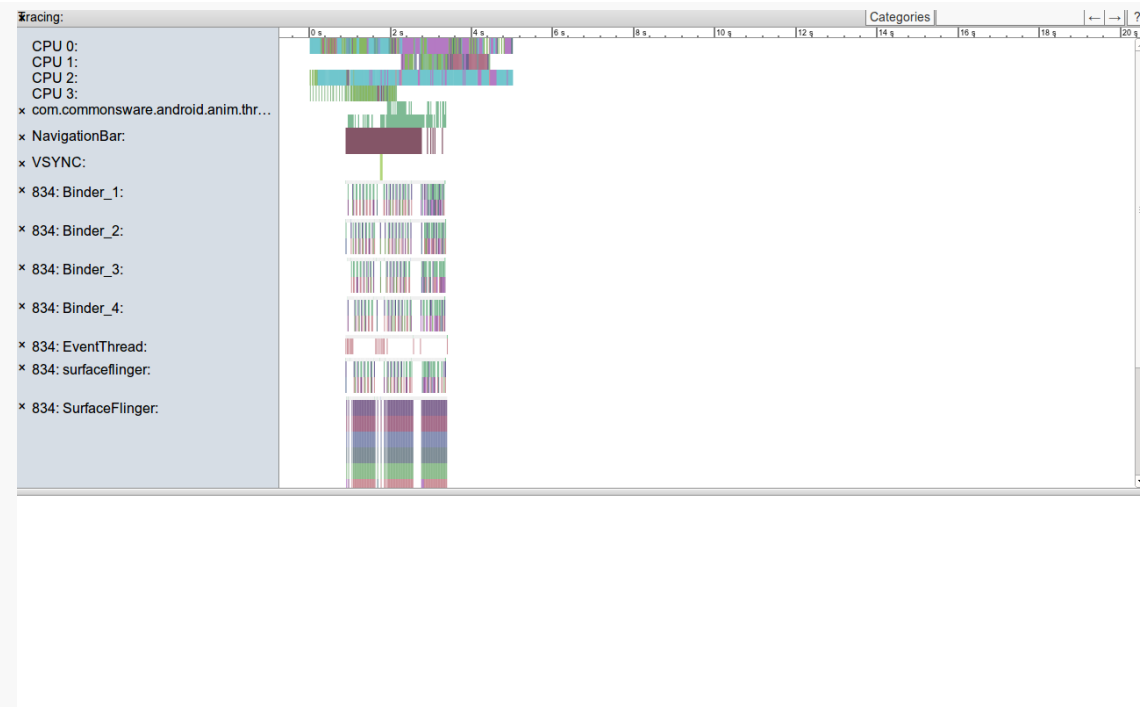
Clicking OK will then initiate the trace collection, at which point you will want to go to your test device and run through your test scenario.

### Viewing and Interpreting the Results

What you get as output is an HTML file that can be viewed in any modern browser, though you will tend to want to use a development machine for this instead of, say, an Android tablet. That is because the navigation of the Web page is designed for use with a hardware QWERTY keyboard, which most Android devices lack.

## FINDING CPU BOTTLENECKS

You can find [a sample trace](#) from a Nexus 7 online, though note that the HTML is a bit large and may take a few seconds to download. Initially, you will see something like this:



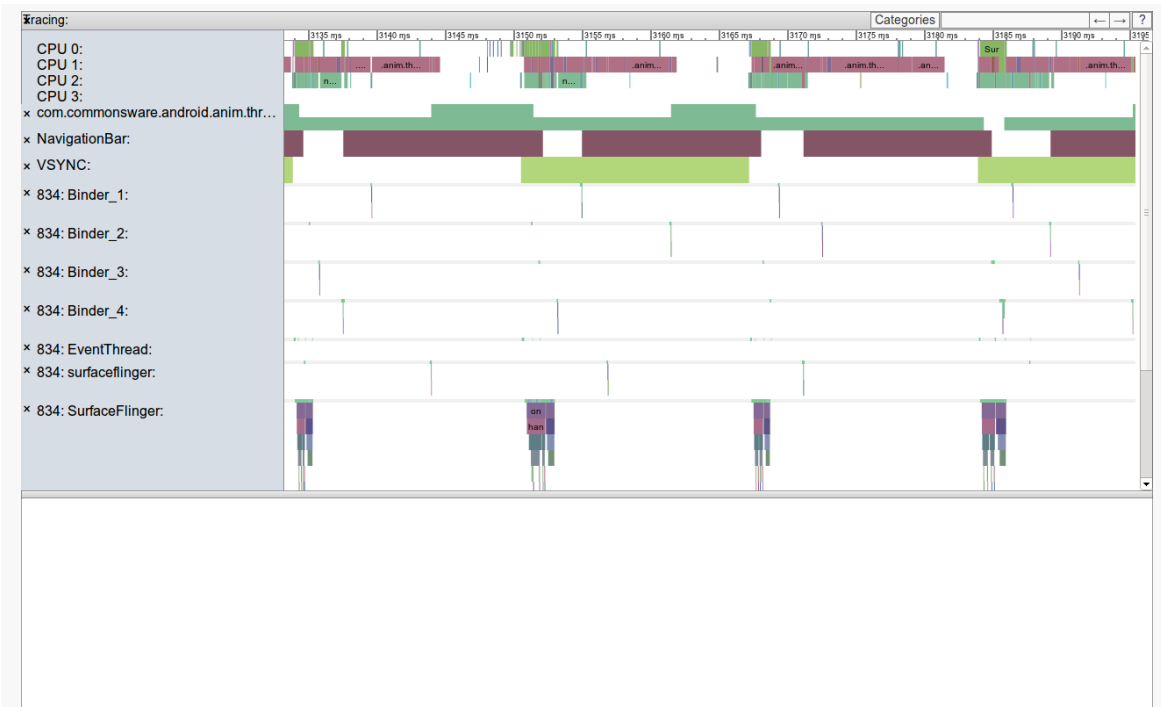
*Figure 474: Systrace Output, As Initially Viewed*

The left-hand sidebar represents various categories (or “slices” or “tags” or whatever) of data collected by systrace. The main area shows a timeline for the test, with rows corresponding to the sidebar entries for what was occurring at the various times for that particular category. The bottom pane will hold details that will appear when you click on various little blocks within that timeline.

Mostly, your navigation will use the W, A, S, and D keys, presumably chosen to make it appear as though you are playing a video game. Specifically:

- W will zoom in the timeline, while S will zoom out
- A and D will pane the timeline left and right

## FINDING CPU BOTTLENECKS



*Figure 475: Systrace Output, Zoomed In, Showing 3135ms to 3190ms*

Unfortunately, most of what is in here is not especially well documented. What we want are the `gfx` and `view` tags for our process. It turns out that those tags are displayed in a slice towards the bottom of this output (scroll down the top portion of the HTML using the scrollbar), here labeled “6797: [...]”, where 6797 happens to be our process ID and “[...]” hopefully means something to some Google engineer.

## FINDING CPU BOTTLENECKS

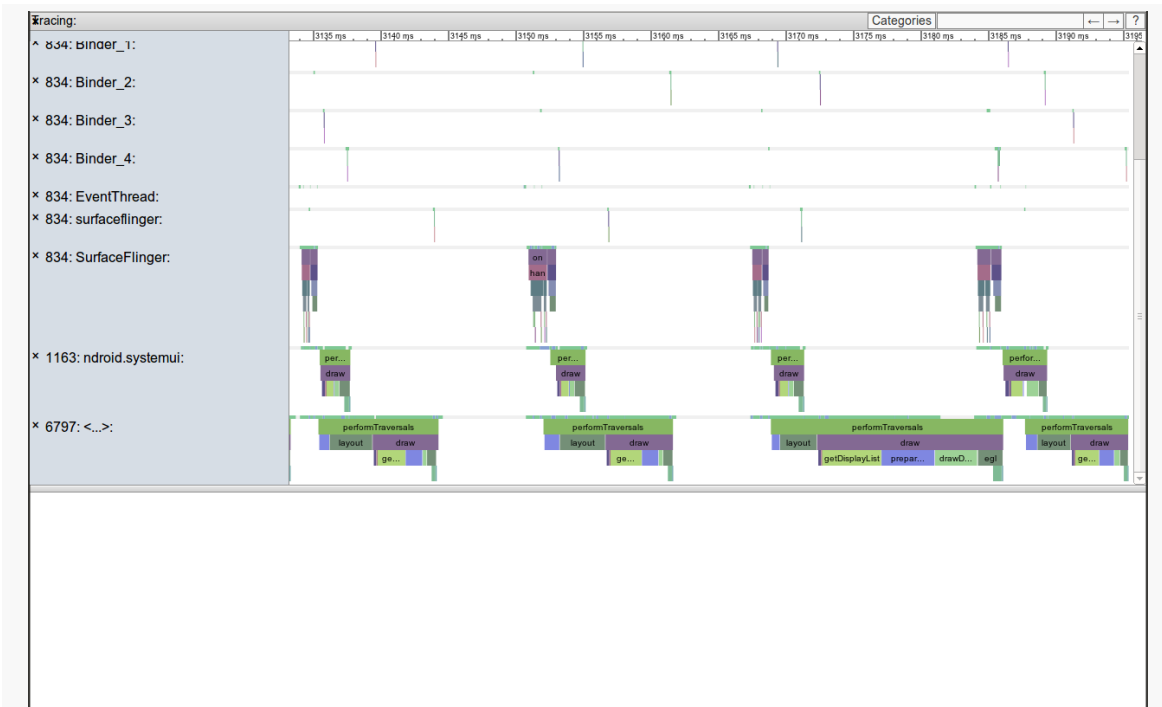


Figure 476: Systrace Output, Showing Semi-Relevant Information

In our gfx/view slice, we will see various blocks for different major operations in the rendering of our UI. Notably, you will see blocks labeled “performTraversals”, referring to the private performTraversals() method on ViewRootImpl. It turns out that performTraversals() wraps around all of the work shown in the three columns of our gfxinfo output: draw, process, and execute. The widths of the “performTraversals” blocks in the systrace output shows us how long each of those takes. What we want are nice, short blocks. Instead, panning through our trace, you will see several that are too long, such as the one running from 3168ms through 3186ms of the timeline. That is 18ms, which exceeds the 16ms of time we have for a frame, and so a frame will be dropped.





# Focus On: NDK

---

When Android was first released, many a developer wanted to run C/C++ code on it. There was little support for this, other than by distributing a binary executable and running it via a forked process. While this works, it is a bit cumbersome, and the process-based interface limits how cleanly your C/C++ code could interact with a Java-based UI. On top of all of that, the use of such binary executables is not well supported.

In June 2009, the core Android team released the Native Development Kit (NDK). This allows developers to write C/C++ for Android applications in a supported fashion, in the form of libraries linked to a hosting Java-based application via the Java Native Interface (JNI). This offers a wealth of opportunities for Android development, and this part of the book will explore how you can take advantage of the NDK to exploit those opportunities.

This chapter explains how to set up the NDK and apply it to your project. What it does not do is attempt to cover all possible uses of the NDK — game applications in particular have access to many frameworks, like OpenGL and OpenSL, that are beyond the scope of this book.

## Prerequisites

Understanding this chapter requires that you have read the core chapters and understand how Android apps are set up and operate. Reading [the introductory chapter to this trail](#) is also a good idea.

This chapter also assumes that you know C/C++ programming.

## The Role of the NDK

We start by examining Dalvik's primary limitation — speed. Next, we look at the reasons one might choose the NDK, speed among them. We wrap up with some reasons why the NDK may not be the right solution for every Android problem, despite its benefits.

### Dalvik: Secure, Yes; Speedy, Not So Much

Dalvik was written with security as a high priority. Android's security architecture is built around Linux's user model, with each application getting its own user ID. With each application's process running under its own user ID, one process cannot readily affect other processes, helping to contain any single security flaw in an Android application or subsystem. This requires a fair number of processes. However, phones have limited RAM, and the Android project wanted to offer Java-based development. Multiple processes hosting their own Java virtual machines simply could not fit in a phone. Dalvik's virtual machine is designed to address this, maximizing the amount of the virtual machine that can be shared securely between processes (e.g., via “copy-on-write”).

Of course, it is wonderful that Android has security so woven into the fabric of its implementation. However, inventing a new virtual machine required tradeoffs, and most of those are related to speed.

A fair amount of work has gone into making Java fast. Standard Java virtual machines do a remarkable job of optimizing applications on the fly, such that Java applications can perform at speeds near their C/C++ counterparts. This borders on the amazing and is a testament to the many engineers who put countless years into Java.

Dalvik, by comparison, is very young. Many of Java's performance optimization techniques — such as advanced garbage collection algorithms — simply have not been implemented to nearly the same level in Dalvik. This is not to say they will never exist, but it will take some time. Even then, though, there may be limits as to how fast Dalvik can operate, considering that it cannot “throw memory at the problem” to the extent Java can on the desktop or server.

If you need speed, Dalvik is not the answer today, and may not be the answer tomorrow, either.

### Going Native

Java-based Android development via Dalvik and the Android SDK is far and away the option with the best support from the core Android team. HTML5 application development is another option that was brought to you by the core Android development team. The third leg of the official Android development triad is the NDK, provided to developers to address some specific problems, outlined below.

### Speed

Far and away the biggest reason for using the NDK is speed, pure and simple. Writing in C/C++ for the device's CPU will be a major speed improvement over writing the same algorithms in Java, despite Android's just-in-time (JIT) compiler.

There is overhead in reaching out to the C/C++ code from a hosting Java application, and so for the best performance, you will want a coarse interface, without a lot of calls back and forth between Java and the native opcodes. This may require some redesign of what might otherwise be the “natural” way of writing the C/C++ code, or you may just have to settle for less of a speed improvement. Regardless, for many types of algorithms — from cryptography to game AI to video format conversions — using C/C++ with the NDK will make your application perform much better, to the point where it can enable applications to be successful that would be entirely too slow if written solely in Java.

Bear in mind, though, that much of what you think is Java code in your app really is native “under the covers”. Many of the built-in Android classes are thin shims over native implementations. Again, focus on applying the NDK where you are performing lots of work yourself in Java code that might benefit from the performance gains.

### Porting

You may already have some C/C++ code, written for another environment, that you would like to use with Android. That might be for a desktop application. That might be for another mobile platform, such as iOS, where C/C++ is an option. That might be for mobile platform, such as Symbian, where C/C++ is the conventional solution, rather than some other language. Regardless, so long as that code is itself relatively platform-independent, it should be usable on Android.

This may significantly streamline your ability to support multiple platforms for your application, even if down-to-the-metal speed is not really something you necessarily need. This may also allow you to reuse existing C/C++ code written by others, for image processing or scripting languages or anything else.

### Knowing Your Limits

Developers love silver bullets. Developers are forevermore seeking The One True Approach to development that will be problem-free. Sisyphus would approve, of course, as development always involves tradeoffs. So while the NDK's speed may make it tantalizing, it is not a solution for general Android application development, for several reasons, explored in this section.

### Android APIs

The biggest issue with the NDK is that you have very limited access to Android itself. There are a few libraries bundled with Android that you can leverage, and a few other APIs offered specifically to the NDK, such as the ability to render OpenGL 3D graphics. But, generally speaking, the NDK has no access to the Android SDK, except by way of objects made available to it from the hosting application via JNI.

As such, it is best to view the NDK as a way of speeding up particular pieces of an SDK application — game physics, audio processing, OCR, and the like. All of those are algorithms that need to run on Android devices with data obtained from Android, but otherwise are independent of Android itself.

### Cross-Platform Compatibility

While C/C++ *can* be written for cross-platform use, often it is not.

Sometimes, the disparity is one of APIs. Any time you use an API from a platform (e.g., iPhone) or a library (e.g., Qt) not available on Android, you introduce an incompatibility. This means that while a lot of your code — measured in terms of lines — may be fine for Android, there may be enough platform-specific bits woven throughout it that you would have a significant rewrite ahead of you to make it truly cross-platform.

Android itself, though, has a compatibility issue, in terms of CPUs. Android mostly runs on ARM devices today, since Android's initial focus was on smartphones, and ARM-powered smartphones at that. However, the focus on ARM will continue to

waver, particularly as Android moves into other devices where other CPU architectures are more prevalent, such as Atom or MIPS for set-top boxes. While your code may be written in a fashion that works on all those architectures, the binaries that code produces will be specific to one architecture. The NDK gives you additional assistance in managing that, so that your application can simultaneously support multiple architectures. Right now, the r6 version of the NDK is for ARM and x86.

### **Maturity**

The Dalvik VM is young. The NDK is younger still, debuting in mid-2009. Fewer developers have been using the NDK than have been using the SDK. The combination of age and usage gives the NDK a fairly short track record, meaning that there may be more NDK problems than are presently known.

### **Available Expertise**

If you are seeking outside assistance for your Android development efforts, there will be fewer people available to assist you with NDK development, compared to SDK development. The NDK is newer than the SDK, so many developers started with what was originally available. Many applications do not need the NDK, and so many developers will not have taken the time to learn how to use it. Furthermore, many Android developers may be far more fluent in Java than they are in C/C++, based on their own backgrounds, and so they would tend to stick with tools they are more comfortable with. To top it off, few books on Android development cover the NDK, though this is being incrementally improved, via books such as this one.

If you are looking for somebody with NDK experience, *ask for it* – do not assume that Android developers know the NDK nearly as well as they know the SDK.

## **NDK Installation and Project Setup**

The Android NDK is blissfully easy to install, in some ways even easier than is the Android SDK. Similarly, setting up an NDK-equipped project is rather straightforward. However, the documentation for the NDK is mostly a set of text files (OVERVIEW.TXT prominent among them). These are well-written but suffer from the limits of the plain-text form factor, plus are focused strictly on the NDK and not the larger issue of Android projects that use the NDK.

This chapter will fill in some of those gaps.

### Installing the NDK

As with the Android SDK, the [Android NDK comes in the form of a ZIP file](#), containing everything you need to build NDK-enabled Android applications. Hence, setting up the NDK is fairly trivial, particularly if you are developing on Linux.

### Prerequisites

You will need the GNU `make` and GNU `awk` packages installed. These may be part of your environment already. For example, in Ubuntu, run `sudo aptitude install make gawk`, or use the Synaptic Package Manager, to ensure you have these two packages.

While you can do NDK development directly on Linux or OS X, NDK development on Windows can only be done using the [Cygwin](#) environment. This gives you a Linux-style shell and Linux-style tools on a Windows PC. In addition to a base Cygwin 1.7 (or newer) installation, you will need the `make` and `gawk` Cygwin packages installed in Cygwin.

If you encounter difficulties with Cygwin, you may wish to consider whether running Linux in a virtualization environment (e.g., [VirtualBox](#)) might be a better solution for you.

### Download and Unpack

The Android NDK per-platform (Linux/OS X/Windows) ZIP files can be downloaded from the [NDK page](#) on the Android Developers site. These ZIP files are not small (~50MB each), because they contain the entire toolchain — that is why there are so few prerequisites.

You are welcome to unpack the ZIP file anywhere it makes sense on your development machine. However, putting it *inside* the Android SDK directory may not be a wise move — a peer directory would be a safer choice. You are welcome to rename the directory if you choose.

### Environment Variables

The NDK documentation will cite an NDK environment variable, set to point to the directory in which you unpacked the NDK. This is a documentation convention and does not appear to be required for actual use of the NDK, though it is not a bad idea.

You could also consider adding the NDK directory to your PATH, though that too is not required.

Bear in mind that you will be using the NDK tools from the command line, and so being able to conveniently reference this directory is reasonably important.

### Setting Up an NDK Project

At its core, an NDK-enhanced Android project is a regular Android project. You still need a manifest, layouts, Java source code, and all the other trappings of a regular Android application. The NDK simply enables you to add C/C++ code to that project and have it included in your builds, referenced from your Java code via the Java Native Interface (JNI).

The examples shown in this section are from the [JNI/WeakBench](#) sample project, which implements a pair of benchmarks in Java and C, to help demonstrate the performance differences between the environments.

### Writing Your C/C++ Code

The first step towards adding NDK code to your project is to create a `jni/` directory and place your C/C++ code inside of it. While there are ways to use a different base directory, it is unclear why you would need to. How you organize the code inside of `jni/` is up to you. C++ code should use `.cpp` as file extensions, though this too is configurable.

Your C/C++ code will be made up of two facets:

- The code doing the real work
- The code implementing your JNI interface

If you have never used JNI before, JNI uses naming conventions to tie functions in a C/C++ library to their corresponding hooks in the Java code.

For example, in the `WeakBench` project, you will find `jni/weakbench.c`:

```
#include <stdlib.h>
#include <math.h>
#include <jni.h>

typedef unsigned char boolean;
```



## FOCUS ON: NDK

---

```
static void nsieve(int m) {
    unsigned int count = 0, i, j;
    boolean * flags = (boolean *) malloc(m * sizeof(boolean));
    memset(flags, 1, m);

    for (i = 2; i < m; ++i)
        if (flags[i]) {
            ++count;
            for (j = i << 1; j < m; j += i)
                if (flags[j])
                    flags[j] = 0;
        }

    free(flags);
}

void
Java_com_commonware_android_tuning_weakbench_WeakBench_nsievenative( JNIEnv*
env,
                                                                    jobject
thiz )
{
    int i=0;
    for (i = 0; i < 3; i++)
        nsieve(10000 << (9-i));
}

double eval_A(int i, int j) { return 1.0/((i+j)*(i+j+1)/2+i+1); }

void eval_A_times_u(int N, const double u[], double Au[])
{
    int i,j;
    for(i=0;i<N;i++)
        {
            Au[i]=0;
            for(j=0;j<N;j++) Au[i]+=eval_A(i,j)*u[j];
        }
}

void eval_At_times_u(int N, const double u[], double Au[])
{
    int i,j;
    for(i=0;i<N;i++)
        {
            Au[i]=0;
            for(j=0;j<N;j++) Au[i]+=eval_A(j,i)*u[j];
        }
}

void eval_AtA_times_u(int N, const double u[], double AtAu[])
{ double v[N]; eval_A_times_u(N,u,v); eval_At_times_u(N,v,AtAu); }

void
```

## FOCUS ON: NDK

---

```
Java_com_commonsware_android_tuning_weakbench_WeakBench_specnative( JNIEnv* env,
                                                                    jobject
thiz )
{
    int i;
    int N = 1000;
    double u[N], v[N], vBv, vv;
    for(i=0; i<N; i++) u[i]=1;
    for(i=0; i<10; i++)
    {
        eval_AtA_times_u(N, u, v);
        eval_AtA_times_u(N, v, u);
    }
    vBv=vv=0;
    for(i=0; i<N; i++) { vBv+=u[i]*v[i]; vv+=v[i]*v[i]; }
}
```

Much of the code shown here comes from the [Great Language Benchmarks Game](#), specifically their nsieve and spectral-norm benchmarks. And, much of the code looks like normal C code.

Two functions, though, serve as JNI entry points:

- `Java_com_commonsware_abj_weakbench_WeakBench_nsievenative`
- `Java_com_commonsware_abj_weakbench_WeakBench_specnative`

As will be seen later in this section, these will map to `nsievenative()` and `specnative()` methods on a `com.commonsware.abj.weakbench.WeakBench` class. The Java class (with package) and method names are converted into a function call name, so JNI can identify the function at runtime.

The implementation of these methods do not make use of any Java objects, nor do they return anything — they just implement the benchmark.

## Writing Your Makefile(s)

To tell the NDK tools how to build your code, you will need one or two makefiles.

### Android.mk

This makefile will describe the “module” (library) that you are attempting to add to your Android project by way of the NDK. In it, you will specify the source files that should be compiled and linked into the module. This file, by default, resides in the root of your `jni/` directory.

## FOCUS ON: NDK

---

For example, here is `jni/Android.mk` from the WeakBench project:

```
LOCAL_PATH := $(call my-dir)

include $(CLEAR_VARS)

LOCAL_MODULE     := weakbench
LOCAL_SRC_FILES  := weakbench.c

include $(BUILD_SHARED_LIBRARY)
```

Here, we give the module a name (`weakbench`) and identify the source files that go into it (`weakbench.c`).

It is possible for you to have multiple `Android.mk` files, in multiple subdirectories of `jni/`, to create multiple modules. There is an `ANDROID-MK.TXT` file in the NDK documentation directory that provides more detail on how you can configure complex scenarios like this one.

### Application.mk

There is a separate, optional, makefile that you can have, `Application.mk`, in your `jni/` directory. This is where you can provide compile flags for the build process, which CPU architectures (ARM, x86, etc.) you wish to support, and so on. By default, if you do not have such a file, the NDK build tools will include all modules defined in your `Android.mk` file(s) in your project, compiled for a generic ARM target with software support for floating-point operations.

For basic NDK applications, skipping `Application.mk` is a reasonable choice. Complex projects, or ones specifically aiming to support other CPU architectures (e.g., ARM-v7 CPUs with hardware floating-point support), will need an `Application.mk` file.

The WeakBench project has a one-line `Application.mk` file:

```
APP_ABI := all
```

This tells Android that we want to build the JNI code for all supported CPU architectures. At the time of this writing, that is ARMv5, ARMv7, and x86.

## Building Your Library

Any time you modify your C/C++ code, or the makefiles, you will need to build your NDK library. To do that, from a command prompt in your project's root directory, run the `ndk-build` script found in the NDK's root directory. In other words, if you set up an NDK environment variable to point to where you have the NDK installed, execute `$NDK/ndk-build` from your project root.

This will compile and link your C/C++ code into a library (or conceivably several libraries, if you have a complex set of `Android.mk` files). These will wind up in your project's `libs/` directory, in subdirectories based on your CPU architectures indicated by your `Application.mk` file.

For example, if you run `$NDK/ndk-build` from the `WeakBench` project root, you will wind up with a `libs/armeabi/libweakbench.so` file. The `armeabi` portion is because that is the default CPU architecture that the NDK supports, and `WeakBench` did not change the defaults via an `Application.mk` file. The “`weakbench`” portion of `libweakbench.so` is because our `LOCAL_MODULE` value in our `Android.mk` file is `weakbench`. The `lib` prefix is automatically added by the build tools. The `.so` file extension is because our `Android.mk` file indicated that we are building a shared library (via the `BUILD_SHARED_LIBRARY` directive), and `.so` is the standard file extension for shared libraries in Linux (and, hence, Android).

Note that you will also wind up with similar `.so` files in `libs/armeabi-v7a/` and `libs/x86` for those architectures.

You are welcome to add this to your build process, such as adding it to your Ant build script, though it is not automatically included in the build process as defined by Android.

## Using Your Library Via JNI

Now that you have your base C/C++ code being successfully compiled by the NDK, you need to turn your attention towards crafting the bridge between the Dalvik VM and the C/C++ code, following in the conventions of the Java Native Interface (JNI).

This section, while explaining the various steps involved in using the JNI, is far from a complete treatise on the subject. If you are going to spend a lot of time working with JNI, you are encouraged to seek additional resources on this topic, such as [Core Java: Volume II](#), which has a chapter on JNI.

## FOCUS ON: NDK

---

We created two C functions for accessing benchmarks:

- `Java_com_commonsware_abj_weakbench_WeakBench_nsievenative`
- `Java_com_commonsware_abj_weakbench_WeakBench_specnative`

Those, in turn, need to be defined as static methods on a `com.commonsware.abj.weakbench.WeakBench` class. Moreover, these methods will need to have the `native` keyword, indicating that their implementation is not found in Java code, but in native C/C++ code. The naming convention of the C functions allows the Dalvik runtime to identify what function names should be used for those native method implementations.

However, that alone will be insufficient — we need to tell Dalvik where it can find the library in the first place. While naming conventions are good enough for the C function names, there is no corresponding naming convention for the library itself.

To do this, we use the `loadLibrary()` static method on the `System` class. A class implementing native methods should call `loadLibrary()` in a static block, so it is executed when the class is first referenced. For the NDK, all we need to do is supply the name we gave the library in the `Android.mk` file.

Here is the portion of the `WeakBench` class that has the native methods and the `loadLibrary()` call:

```
static {  
    System.loadLibrary("weakbench");  
}  
  
public native void nsievenative();  
public native void specnative();
```

Now, we can call our `nsievenative()` and `specnative()` methods on `WeakBench`, just as if they were regular Dalvik methods on a regular Dalvik class. The fact that they are really going off and invoking C functions is purely “implementation detail” that the consumers of those methods can be blissfully unaware of.

`WeakBench` itself is an `Activity`, invoking both Dalvik and native implementations of these two benchmarks. It uses a series of `AsyncTask` objects for executing the benchmarks on background threads, then updates `TextView` widgets in the UI to show the results:

```
package com.commonsware.android.tuning.weakbench;
```

## FOCUS ON: NDK

---

```
import android.app.Activity;
import android.os.AsyncTask;
import android.os.Bundle;
import android.os.SystemClock;
import android.widget.TextView;

public class WeakBench extends Activity {
    static {
        System.loadLibrary("weakbench");
    }

    public native void nsieve();
    public native void spec();

    @Override
    public void onCreate(Bundle savedInstanceState) {
        super.onCreate(savedInstanceState);
        setContentView(R.layout.main);

        new JavaSieveTask().execute();
    }

    /*
     * Code after this point is adapted from the Great Computer Language
     * Shootout. Copyrights are owned by whoever contributed this stuff,
     * or possibly the Shootout itself, since there isn't much information
     * on ownership there. Licensed under a modified BSD license.
     */

    private class JavaSieveTask extends AsyncTask<Void, Void, Void> {
        long start=0;
        TextView result=null;

        @Override
        protected void onPreExecute() {
            result=(TextView)findViewById(R.id.nsieve_java);

            result.setText("running...");
        }

        @Override
        protected Void doInBackground(Void... unused) {
            start=SystemClock.uptimeMillis();

            int n=9;
            int m=(1<<n)*10000;
            boolean[] flags=new boolean[m+1];

            nsieve(m, flags);

            m=(1<<n-1)*10000;
            nsieve(m, flags);

            m=(1<<n-2)*10000;
```

## FOCUS ON: NDK

---

```
    nsieve(m, flags);

    return(null);
}

@Override
protected void onPostExecute(Void unused) {
    long delta=SystemClock.uptimeMillis()-start;

    result.setText(String.valueOf(delta));
    new JavaSpecTask().execute();
}
}

private class JavaSpecTask extends AsyncTask<Void, Void, Void> {
    long start=0;
    TextView result=null;

    @Override
    protected void onPreExecute() {
        result=(TextView)findViewById(R.id.spec_java);

        result.setText("running...");
    }

    @Override
    protected Void doInBackground(Void... unused) {
        start=SystemClock.uptimeMillis();

        Approximate(1000);

        return(null);
    }

    @Override
    protected void onPostExecute(Void unused) {
        long delta=SystemClock.uptimeMillis()-start;

        result.setText(String.valueOf(delta));
        new JNISieveTask().execute();
    }
}

private class JNISieveTask extends AsyncTask<Void, Void, Void> {
    long start=0;
    TextView result=null;

    @Override
    protected void onPreExecute() {
        result=(TextView)findViewById(R.id.nsieve_jni);

        result.setText("running...");
    }
}
```

## FOCUS ON: NDK

---

```
@Override
protected Void doInBackground(Void... unused) {
    start=SystemClock.uptimeMillis();

    nsieveNative();

    return(null);
}

@Override
protected void onPostExecute(Void unused) {
    long delta=SystemClock.uptimeMillis()-start;

    result.setText(String.valueOf(delta));
    new JNISpecTask().execute();
}
}

private class JNISpecTask extends AsyncTask<Void, Void, Void> {
    long start=0;
    TextView result=null;

    @Override
    protected void onPreExecute() {
        result=(TextView)findViewById(R.id.spec_jni);

        result.setText("running...");
    }

    @Override
    protected Void doInBackground(Void... unused) {
        start=SystemClock.uptimeMillis();

        specNative();

        return(null);
    }

    @Override
    protected void onPostExecute(Void unused) {
        long delta=SystemClock.uptimeMillis()-start;

        result.setText(String.valueOf(delta));
    }
}

private static int nsieve(int m, boolean[] isPrime) {
    for (int i=2; i <= m; i++) isPrime[i] = true;
    int count = 0;

    for (int i=2; i <= m; i++) {
        if (isPrime[i]) {
            for (int k=i+i; k <= m; k+=i) isPrime[k] = false;
            count++;
        }
    }
}
```



```
    }
  }
  return count;
}

private final double Approximate(int n) {
  // create unit vector
  double[] u = new double[n];
  for (int i=0; i<n; i++) u[i] = 1;

  // 20 steps of the power method
  double[] v = new double[n];
  for (int i=0; i<n; i++) v[i] = 0;

  for (int i=0; i<10; i++) {
    MultiplyAtAv(n,u,v);
    MultiplyAtAv(n,v,u);
  }

  // B=AtA      A multiplied by A transposed
  // v.Bv / (v.v) eigenvalue of v
  double vBv = 0, vv = 0;
  for (int i=0; i<n; i++) {
    vBv += u[i]*v[i];
    vv += v[i]*v[i];
  }

  return Math.sqrt(vBv/vv);
}

/* return element i,j of infinite matrix A */
private final double A(int i, int j){
  return 1.0/((i+j)*(i+j+1)/2 +i+1);
}

/* multiply vector v by matrix A */
private final void MultiplyAv(int n, double[] v, double[] Av){
  for (int i=0; i<n; i++){
    Av[i] = 0;
    for (int j=0; j<n; j++) Av[i] += A(i,j)*v[j];
  }
}

/* multiply vector v by matrix A transposed */
private final void MultiplyAtv(int n, double[] v, double[] Atv){
  for (int i=0; i<n; i++){
    Atv[i] = 0;
    for (int j=0; j<n; j++) Atv[i] += A(j,i)*v[j];
  }
}

/* multiply vector v by matrix A and then by matrix A transposed */
private final void MultiplyAtAv(int n, double[] v, double[] AtAv){
```

```
double[] u = new double[n];
MultiplyAv(n,v,u);
MultiplyAtv(n,u,AtAv);
}
}
```

As with our C implementations of the benchmarks, the Java source code is derived from the [Great Language Benchmarks Game](#).

## Building and Deploying Your Project

Given that you have done all of this, the rest is perfectly normal – you build and deploy your Android project no differently than if you did not have any C/C++ code. Your native library is embedded in your APK file, so you do not have to worry about distributing it separately.

However, bear in mind that the more architectures you choose, the more .so files there are and the bigger your app will be. For tiny bits of C/C++ code, like the code in this app, this increase in file size will not be very noticeable. However, it may be something to keep in mind for more elaborate NDK applications.



# Improving CPU Performance in Java

---

Knowing that you have CPU-related issues in your app is one thing — doing something about it is the next challenge. In some respects, tuning an Android application is a “one-off” job, tied to the particulars of the application and what it is trying to accomplish. That being said, this chapter will outline some general-purpose ways of boosting performance that may counter issues that you are running into.

## Prerequisites

Understanding this chapter requires that you have read the core chapters and understand how Android apps are set up and operate. Reading [the introductory chapter to this trail](#) is also a good idea.

## Reduce CPU Utilization

One class of CPU-related problems come from purely sluggish code. These are the sorts of things you will see in Traceview, for example – methods or branches of code that seem to take an inordinately long time. These are also some of the most difficult to have general solutions for, as often times it comes down to what the application is trying to accomplish. However, the following sections provide suggestions for consuming fewer CPU instructions while getting the same work done.

These are presented in no particular order.

### Standard Java Optimizations

Most of your algorithm fixes will be standard Java optimizations, no different than have been used by Java projects over the past decade and change. This section outlines a few of them. For more, consider reading *Effective Java* by Joshua Bloch or *Java Performance Tuning* by Jack Shirazi.

### Avoid Excessive Synchronization

Few objects in `java.*` namespaces are intrinsically thread-safe, outside of `java.util.concurrent`. Typically, you need to perform your own synchronization if multiple threads will be accessing non-thread-safe objects. However, sometimes, Java classes have synchronization that you neither expect nor need. Synchronization adds unnecessary overhead.

The classic example here is `StringBuffer` and `StringBuilder`. `StringBuffer` was part of Java from early on, and, for whatever reason, was written to be thread-safe — two threads that append to the buffer will not cause any problems. However, most of the time, you are only using the `StringBuffer` from one thread, meaning all that synchronization overhead is a waste. Later on, Java added `StringBuilder`, with the same basic set of methods as has `StringBuffer`, but without the synchronization.

Similarly, in your own code, only synchronize where it is really needed. Do not toss the `synchronized` keyword around randomly, or use concurrent collections that will only be used by one thread, etc.

### Avoid Floating-Point Math

The first generation of Android devices lacked a floating-point coprocessor on the ARM CPU package. As a result, floating-point math speed was atrocious. That is why the Google Maps add-on for Android uses `GeoPoint`, with latitude and longitude in integer microdegrees, rather than the standard Android `Location` class, which uses Java double variables holding decimal degrees.

While later Android devices do have floating-point coprocessor support, that does not mean that floating-point math is now as fast as integer math. If you find that your code is spending lots of time on floating-point calculations, consider whether a change in units would allow you to replace the floating-point calculations with integer equivalents. For example, microdegrees for latitude and longitude provide

adequate granularity for most maps, yet allow Google Maps to do all of its calculations in integers.

Similarly, consider whether the full decimal accuracy of floating-point values is really needed. While it may be physically possible to perform distance calculations in meters with accuracy to a few decimal points, for example, in many cases the user will not need that degree of accuracy. If so, perhaps changing to fixed-point (integer) math can boost your performance.

### **Don't Assume Built-In Algorithms are Best**

Years upon years of work has gone into the implementation of various algorithms that underlie Java methods, like searching for substrings inside of strings.

Somewhat less work has gone into the implementation of the Apache Harmony versions of those methods, simply because the project is younger, and it is a modified version of the Harmony implementation that you will find in Android. While the core Android team has made many improvements to the original Harmony implementation, those improvements may be for optimizations that do not fit your needs (e.g., optimizing to reduce memory consumption at the expense of CPU time).

But beyond that, there are [dozens of string-matching algorithms](#), some of which may be better for you depending on the string being searched and the string being searched for. Hence, you may wish to consider applying your own searching algorithm rather than relying on the built-in one, to boost performance. And, this same concept may hold for other algorithms as well (e.g., sorting).

Of course, this will also increase the complexity of your application, with long-term impacts in terms of maintenance cost. Hence, do not assume the built-in algorithms are the worst, either — optimize those algorithms that Traceview or logging suggest are where you are spending too much time.

### **Support Hardware-Accelerated Graphics**

An easy “win” is to add `android:hardwareAccelerated="true"` to your `<application>` element in the manifest. This toggles on hardware acceleration for 2D graphics, including much of the stock widget framework. For maximum backwards compatibility, this hardware acceleration is off, but adding the aforementioned attribute will enable it for all activities in your application.

Note that this is only available starting with Android 3.0. It is safe to have the attribute in the manifest for older Android devices, as they simply will ignore your request.

You also should test your application thoroughly after enabling hardware acceleration, to make sure there are no unexpected issues. For ordinary widget-based applications, you should encounter no problems. Games or other applications that do their own drawing might have issues. If you find that some of your code runs into problems, you can override hardware acceleration on a per-activity basis by putting the `android:hardwareAccelerated` on `<activity>` elements in the manifest.

### Minimize IPC

Calling a method on an object in your own process is fairly inexpensive. The overhead of the method invocation is fairly minuscule, and so the time involved is simply however long it takes for that method to do its work.

Invoking behaviors in another process, via inter-process communication (IPC), is considerably more expensive. Your request has to be converted into a byte array (e.g., via the `Parcelable` interface), made available to the other process, converted back into a regular request, then executed. This adds substantial CPU overhead.

There are three basic flavors of IPC in Android:

1. “Directly” invoking a third-party application’s service’s AIDL-published interface, to which you bound with `bindService()`
2. Performing operations on a content provider that is not part of your application (i.e., supplied by the OS or a third-party application)
3. Performing other operations that, under the covers, trigger IPC

### Remote Bound Service

Using a remote service is fairly obvious when you do it — it is difficult to mistake copying the AIDL into your project and such. The proxy object generated from the AIDL converts all your method calls on the interface into IPC operations, and this is relatively expensive.

If you are exposing a service via AIDL, design your API to be coarse-grained. Do not require the client to make 1,000 method invocations to accomplish something that can be done in 1 via slightly more complex arguments and return values.

## IMPROVING CPU PERFORMANCE IN JAVA

---

If you are consuming a remote service, try not to get into situations where you have to make lots of calls in a tight loop, or per row of a scrolled `AdapterView`, or anything else where the overhead may become troublesome.

For example, in the [CPU-Java/AIDLOverhead](#) sample project, you will find a pair of projects implementing the same do-nothing method in equivalent services. One uses AIDL and is bound to remotely from a separate client application; the other is a local service in the client application itself. The client then calls the do-nothing method 1 million times for each of the two services. On average, on a Samsung Galaxy Tab 10.1, 1 million calls takes around 170 seconds for the remote service, while it takes around 170 *milliseconds* for the local service. Hence, the overhead of an individual remote method invocation is small (~170 microseconds), but doing lots of them in a loop, or as the user flings a `ListView`, might become noticeable.

### Remote Content Provider

Using a content provider can be somewhat less obvious of a problem. Using `ContentResolver` or `managedQuery()` or a `CursorLoader` looks the same whether it is your own content provider or someone else's. However, you know what content providers you wrote; anything else is probably running in another process.

As with remote services, try to aggregate operations with remote content providers, such as:

1. Use `bulkInsert()` rather than lots of individual `insert()` calls
2. Try to avoid calling `update()` or `delete()` in a tight loop – instead, if the content provider supports it, use a more complex “WHERE clause” to update or delete everything at once
3. Try to get all your data back in few queries, rather than lots of little ones... though this can then cause you issues in terms of memory consumption

### Remote OS Operation

The content provider scenario is really a subset of the broader case where you request that Android do something for you and winds up performing IPC as part of that.

Sometimes, this is going to be obvious. If you are sending commands to a third-party service via `startService()`, by definition, this will involve IPC, since the third-party



service will run in a third-party process. Try to avoid calling `startService()` lots of times in close succession.

However, there are plenty of cases that are less obvious:

1. All requests to `startActivity()`, `startService()`, and `sendBroadcast()` involve IPC, as it is a separate OS process that does the real work
2. Registering and unregistering a `BroadcastReceiver` (e.g., `registerReceiver()`) involves IPC
3. All of the “system services”, such as `LocationManager`, are really rich interfaces to an AIDL-defined remote service, and so most operations on these system services require IPC

Once again, your objective should be to minimize calls that involve IPC, particularly where you are making those calls frequently in close succession, such as in a loop. For example, frequently calling `getLastKnownLocation()` will be expensive, as that involves IPC to a system process.

### Android-Specific Java Optimizations

The way that the Dalvik VM was implemented and operates is subtly different than a traditional Java VM. Therefore, there are some optimizations that are more important on Android than you might find in regular desktop or server Java.

The Android developer documentation has [a roster of such optimizations](#). Some of the highlights include:

1. Getters and setters, while perhaps useful for encapsulation, are significantly slower than direct field access. For simpler cases, such as `ViewHolder` objects for optimizing an `Adapter`, consider skipping the accessor methods and just use the fields directly.
2. Some popular method calls are replaced by hand-created assembler instructions rather than code generated via the JIT compiler. `indexOf()` on `String` and `arraycopy()` on `System` are two cited examples. These will run much faster than anything you might create yourself in Java.

### Reduce Time on the Main Application Thread

Another class of CPU-related problem is when your code may be efficient, but it is occurring on the main application thread, causing your UI to react sluggishly. You

might have tuned your decryption algorithm as best as is mathematically possible, but it may be that decrypting data on the main application thread simply takes too much time. Or, perhaps `StrictMode` complained about some disk or network I/O that you are performing on the main application thread.

The following sections recap some commonly-seen patterns for moving work off the main application thread, plus a few newer options that you may have missed.

### Generate Less Garbage

Most developers think of having too many allocations as being solely an issue of heap space. That certainly has an impact, and depending on the nature of the allocations (e.g., bitmaps), it may be the dominant issue.

However, garbage has impacts from a CPU standpoint as well. Every object you create causes its constructor to be executed. Every object that is garbage-collected requires CPU time both to find the object in the heap and to actually clean it up (e.g., execute the finalizer, if any).

Worse still, on older versions of Android (e.g., Android 2.2 and down), the garbage collector interrupts the entire process to do its work, so the more garbage you generate, the more times you “stop the world”. Game developers have had to deal with this since Android’s inception. To maintain a 60 FPS refresh rate, you cannot afford *any* garbage collections on older devices, as a single GC run could easily take more than the ~16ms you have per drawing pass.

As a result of all of this, game developers have had to carefully manage their own object pools, pre-allocating a bunch of objects before game play begins, then using and recycling those objects themselves, only allowing them to become garbage after game play ends.

Most non-game Android applications may not have to go to quite that extreme across the board. However, there are cases where excessive allocation may cause you difficulty. For example, avoiding creating too much garbage is one aspect of view recycling with `AdapterView`, which is covered in greater detail [in the next section](#).

If Traceview indicates that you are spending a lot of time in garbage collection, pay attention to your loops or things that may be invoked many times in rapid succession (e.g., accessing data from a custom `Cursor` implementation that is tied to a `CursorAdapter`). These are the most likely places where your own code might be creating lots of extra objects that are not needed. Examining the heap to see what is

all being created (and eventually garbage collected) will be covered in [an upcoming chapter of the book](#).

### View Recycling

Perhaps the best-covered Android-specific optimization is view recycling with `AdapterView`.

In a nutshell, if you are extending `BaseAdapter`, or if you are overriding `getView()` in another adapter, please make use of the `View` parameter supplied to `getView()` (referred to here as `convertView`). If `convertView` is not null, it is one of your previous `View` objects you returned from `getView()` before, being offered to you for recycling purposes. Using `convertView` saves you from inflating or manually constructing a fresh `View` every time the user scrolls, and both of those operations are relatively expensive.

If you have been ignoring `convertView` because you have more than one type of `View` that `getView()` returns, your `Adapter` should be overriding `getViewTypeCount()` and `getItemViewType()`. These will allow Android to maintain separate object pools for each type of row from your `Adapter`, so `getView()` is guaranteed to be passed a `convertView` that matches the row type you are trying to create.

A somewhat more advanced optimization — caching all those `findViewById()` lookups — is also possible once your row recycling is in place. Often referred to as “the holder pattern”, you do the `findViewById()` calls when you inflate a new row, then attach the `findViewById()` results to the row itself via some custom “holder” object and the `setTag()` method on `View`. When you recycle the row, you can get your “holder” back via `getTag()` and skip having to do the `findViewById()` calls again.

### Background Threads

Of course, the backbone of any strategy to move work off the main application thread is to use background threads, in one form or fashion. You will want to apply these in places where `StrictMode` complains about network or disk I/O, or places where `Traceview` or logging indicate that you are taking too much time on the main application thread during GUI processing (e.g., converting downloaded bitmap images into `Bitmap` objects via `BitmapFactory`).

Sometimes, you will manually dictate where work should be done in the background, either by forking threads yourself or by using `AsyncTask`. `AsyncTask` is a

nice framework, handling all of the inter-thread communication for you and neatly packaging up the work to be done in readily understood methods. However, `AsyncTask` does not fit every scenario — it is mostly designed for “transactional” work that is known to take a modest amount of time (milliseconds to seconds) then end. For cases where you need unbounded background processing, such as monitoring a socket for incoming data, forking your own thread will be the better approach.

Sometimes, you will use facilities supplied by Android to move work to the background. For example, many activities are backed by a `Cursor` obtained from a database or content provider. Classically, you would manage the cursor (via `startManagingCursor()`) or otherwise arrange to refresh that `Cursor` in `onResume()`, so when your activity returns to the foreground after having been gone for a while, you would have fresh data. However, this pattern tends to lead to database I/O on the main application thread, triggering complaints from `StrictMode`. Android 3.0 and the Android Compatibility Library offer a `Loader` framework designed to try to solve the core pattern of refreshing the data, while arranging for the work to be done asynchronously.

### Asynchronous BroadcastReceiver Operations

99.44% of the time (approximately) that Android calls your code in some sort of event handler, you are being called on the main application thread. This includes manifest-registered `BroadcastReceiver` components — `onReceive()` is called on the main application thread. So any work you do in `onReceive()` ties up that thread (possibly impacting an activity of yours in the foreground), and if you take more than 10 seconds, Android will terminate your `BroadcastReceiver` with extreme prejudice.

Classically, manifest-registered `BroadcastReceiver` components only live as long as the `onReceive()` call does, meaning you can do very little work in the `BroadcastReceiver` itself. The typical pattern is to have it send a command to a service via `startService()`, where the service “does the heavy lifting”.

Android 3.0 added a `goAsync()` method on `BroadcastReceiver` that can help a bit here. While under-documented, it tells Android that you need more time to complete the broadcast work, but that you can do that work on a background thread. This does not eliminate the 10-second rule, but it does mean that the `BroadcastReceiver` can do some amount of I/O without having to send a command to a service to do it while still not tying up the main application thread.

## IMPROVING CPU PERFORMANCE IN JAVA

---

The [CPU-Java/GoAsync](#) sample project demonstrates `goAsync()` in use, as the project name might suggest.

Our activity's layout consists of two `Button` widgets and an `EditText` widget:

```
<?xml version="1.0" encoding="utf-8"?>
<LinearLayout xmlns:android="http://schemas.android.com/apk/res/android"
    android:orientation="vertical" android:layout_width="fill_parent"
    android:layout_height="fill_parent">
    <EditText android:id="@+id/editText1" android:layout_width="match_parent"
        android:layout_height="wrap_content">
    </EditText>
    <Button android:layout_width="match_parent" android:id="@+id/button1"
        android:layout_height="wrap_content" android:text="@string/nonasync"
        android:onClick="sendNonAsync"></Button>
    <Button android:layout_width="match_parent" android:id="@+id/button2"
        android:layout_height="wrap_content" android:text="@string/async"
        android:onClick="sendAsync"></Button>
</LinearLayout>
```

The activity itself simply has `sendAsync()` and `sendNonAsync()` methods, each invoking `sendBroadcast()` to a different `BroadcastReceiver` implementation:

```
package com.commonware.android.tuning.goasync;

import android.app.Activity;
import android.content.Intent;
import android.os.Bundle;
import android.view.View;

public class GoAsyncActivity extends Activity {
    @Override
    public void onCreate(Bundle savedInstanceState) {
        super.onCreate(savedInstanceState);
        setContentView(R.layout.main);
    }

    public void sendAsync(View v) {
        sendBroadcast(new Intent(this, AsyncReceiver.class));
    }

    public void sendNonAsync(View v) {
        sendBroadcast(new Intent(this, NonAsyncReceiver.class));
    }
}
```

The `NonAsyncReceiver` simulates doing time-consuming work in `onReceive()` itself:

```
package com.commonware.android.tuning.goasync;

import android.content.BroadcastReceiver;
```

## IMPROVING CPU PERFORMANCE IN JAVA

---

```
import android.content.Context;
import android.content.Intent;
import android.os.SystemClock;

public class NonAsyncReceiver extends BroadcastReceiver {
    @Override
    public void onReceive(Context arg0, Intent arg1) {
        SystemClock.sleep(7000);
    }
}
```

Hence, if you click the “Send Non-Async Broadcast” button, not only will the button fail to return to its normal state for seven seconds, but the EditText will not respond to user input either.

The AsyncReceiver, though, uses `goAsync()`:

```
package com.commonware.android.tuning.goasync;

import android.content.BroadcastReceiver;
import android.content.Context;
import android.content.Intent;
import android.os.SystemClock;

public class AsyncReceiver extends BroadcastReceiver {
    @Override
    public void onReceive(Context context, Intent intent) {
        final BroadcastReceiver.PendingResult result=goAsync();

        (new Thread() {
            public void run() {
                SystemClock.sleep(7000);
                result.finish();
            }
        }).start();
    }
}
```

The `goAsync()` method returns a `PendingResult`, which supports a series of methods that you might ordinarily fire on the `BroadcastReceiver` itself (e.g., `abortBroadcast()`) but want to do on a background thread. You need your background thread to have access to the `PendingResult` — in this case, via a `final` local variable. When you are done with your work, call `finish()` on the `PendingResult`.

If you click the “Send Async Broadcast” button, even though we are still sleeping for 7 seconds, we are doing so on a background thread, and so our user interface is still responsive.

### Saving SharedPreferences

The classic way to save `SharedPreferences.Editor` changes was via a call to `commit()`. This writes the preference information to an XML file on whatever thread you are on — another hidden source of disk I/O you might be doing on the main application thread.

If you are on API Level 9, and you are willing to blindly try saving the changes, use the new `apply()` method on `SharedPreferences.Editor`, which works asynchronously.

If you need to support older versions of Android, or you really want the boolean return value from `commit()`, consider doing the `commit()` call in an `AsyncTask` or background thread.

And, of course, to support both of these, you will need to employ tricks like conditional class loading. You can see that used for saving `SharedPreferences` in the [CPU-Java/PrefsPersist](#) sample project. The activity reads in a preference, puts the current value on the screen, then updates the preference with the help of an `AbstractPrefsPersistStrategy` class and its `persist()` method:

```
package com.commonware.android.tuning.prefs;

import android.app.Activity;
import android.content.SharedPreferences;
import android.os.Bundle;
import android.preference.PreferenceManager;
import android.widget.TextView;

public class PrefsPersistActivity extends Activity {
    private static final String KEY="counter";

    @Override
    public void onCreate(Bundle savedInstanceState) {
        super.onCreate(savedInstanceState);
        setContentView(R.layout.main);

        SharedPreferences prefs=
            PreferenceManager.getDefaultSharedPreferences(this);
        int counter=prefs.getInt(KEY, 0);

        ((TextView)findViewById(R.id.value)).setText(String.valueOf(counter));

        AbstractPrefsPersistStrategy.persist(prefs.edit().putInt(KEY, counter+1));
    }
}
```

## IMPROVING CPU PERFORMANCE IN JAVA

---

AbstractPrefsPersistStrategy is an abstract base class that will hold a strategy implementation, depending on Android version. On pre-Honeycomb builds, it uses an implementation that forks a background thread to perform the commit():

```
package com.commonware.android.tuning.prefs;

import android.content.SharedPreferences;
import android.os.Build;

abstract public class AbstractPrefsPersistStrategy {
    abstract void persistAsync(SharedPreferences.Editor editor);

    private static final AbstractPrefsPersistStrategy INSTANCE=initImpl();

    public static void persist(SharedPreferences.Editor editor) {
        INSTANCE.persistAsync(editor);
    }

    private static AbstractPrefsPersistStrategy initImpl() {
        int sdk=new Integer(Build.VERSION.SDK).intValue();

        if (sdk<Build.VERSION_CODES.HONEYCOMB) {
            return(new CommitAsyncStrategy());
        }

        return(new ApplyStrategy());
    }

    static class CommitAsyncStrategy extends AbstractPrefsPersistStrategy {
        @Override
        void persistAsync(final SharedPreferences.Editor editor) {
            (new Thread() {
                @Override
                public void run() {
                    editor.commit();
                }
            }).start();
        }
    }
}
```

On Honeycomb and higher, it uses a separate strategy class that uses the new apply() method:

```
package com.commonware.android.tuning.prefs;

import android.content.SharedPreferences.Editor;

public class ApplyStrategy extends AbstractPrefsPersistStrategy {

    @Override
    void persistAsync(Editor editor) {
```



```
    editor.apply();  
  }  
}
```

By separating the Honeycomb-specific code out into a separate class, we can avoid loading it on older devices and encountering the dreaded `VerifyError`.

Whether using the built-in `apply()` method is worth dealing with multiple strategies, versus simply calling `commit()` on a background thread, is up to you.

## Improve Throughput and Responsiveness

Being efficient and doing work on the proper thread may still not be enough. It could be that your work is not consuming excessive CPU time, but is taking too long in “wall clock time” (e.g., the user sits waiting too long at a `ProgressDialog`). Or, it could be that your work, while efficient and in the background, is causing difficulty for foreground operations.

The following sections outline some common problems and solutions in this area.

### Minimize Disk Writes

Earlier in this book, we emphasized moving disk writes off to background threads.

Even better is to get rid of some of the disk writes entirely.

A big culprit here comes in the form of database operations. By default, each `insert()`, `update()`, or `delete()`, or any `execSQL()` invocation that modifies data, will occur in its own transaction. Each transaction involves a set of disk writes. Many times, this is not a problem. But, if you are doing a lot of these – such as importing records from a CSV file — hundreds or thousands of transactions will mean thousands of individual disk writes, and that can take some time. You may wish to wrap those operations in your own transaction, using methods like `beginTransaction()`, simply to reduce the number of transactions and, therefore, disk writes.

If you are doing your own disk I/O beyond databases, you may encounter similar sorts of issues. Overall, it is better to do a few larger writes than lots of little ones.

### Set Thread Priority

Threads you fork, by default, run at a default priority: `THREAD_PRIORITY_DEFAULT` as defined on the `Process` class. This is a lower priority than the main application thread (`THREAD_PRIORITY_DISPLAY`).

Threads you use via `AsyncTask` run at a lower priority (`THREAD_PRIORITY_BACKGROUND`). If you fork your own threads, then, you might wish to consider moving them to a lower priority as well, to affect how much time they get compared to the main application thread. You can do this via `setThreadPriority()` on the `Process` class.

The lowest possible priority, `THREAD_PRIORITY_LOWEST`, is described as “only for those who really, really don’t want to run if anything else is happening”. You might use this for “idle-time processing”, but bear in mind that the thread will be paused a lot to allow other threads to run.

Lower-priority threads will help ensure that your background work does not affect your foreground UI. Processes themselves are put in a lower-priority class as they move to the background (e.g., you have no activities visible), which further reduces the amount of CPU time you will be using at any given moment.

Also, note that `IntentService` uses a thread at default (*not* background) priority — you may wish to drop the priority of this thread to something that will be lower than your main application thread, to minimize how much CPU time the `IntentService` steals from your UI.

### Do the Work Some Other Time

Just because you could do the work now does not mean you should do the work now. Perhaps a better answer is to do the work later, or do part of the work now and part of the work later.

For example, suppose that you have your own database of points of interest for your custom map application. Periodically, you publish a new database on your Web site, which your Android app should download. Odds are decent that the user is not in desperate need for this new database right away. In fact, the CPU time and disk I/O time to download and save the database might incrementally interfere with the foreground application, despite your best efforts.

## IMPROVING CPU PERFORMANCE IN JAVA

---

In this case, not only should you check for and download the database when the user is unlikely to be using the device (e.g., before dawn), but you should check whether the screen is on via `isScreenOn()` on `PowerManager`, and delay the work to sometime when the screen is off. For example, you could have `AlarmManager` set up to have your code check for updates every 24 hours at 4am. If, at 4am, the screen is on, your code could skip the download and wait until tomorrow, or skip the download and add a one-shot alarm to wake you up in 30 minutes, in hopes that the user will no longer be using the device.

At the same time, you may wish to consider having a “refresh” menu choice somewhere, for when the user specifically wants you to go get the update (if available) *now*, for whatever reason.

# Finding and Eliminating Jank

---

A user interface is considered “janky” if it stutters or otherwise fails to operate smoothly, particularly during animated effects like scrolling. Finding and eliminating the causes of janky behavior (“jank”) is part science, part art, and part throwing darts at a dartboard.

This chapter will outline some techniques for identifying and removing jank from a user interface. The steps shown here originated in [a blog post by Google’s Romain Guy](#), with a few additional twists and turns due to the different nature of the particular case being studied. Mr. Guy’s blog post is essential reading for all advanced Android developers, and the author is deeply indebted to Mr. Guy for his work in this area.

## Prerequisites

The only hard prerequisite for this chapter is having read the core chapters and [the chapter on finding CPU bottlenecks](#).

That being said, having read [the chapter on animators](#) would help understand portions of this chapter a bit better.

## The Case: ThreePaneDemoBC

In [the chapter on animators](#), we examined an implementation of the Gmail-style three-pane layout with animated transitions (a.k.a., “[The Three-Fragment Problem](#)”). The implementation shown there originated with [a StackOverflow question](#) with the solution presented in this book offered as [an answer](#).

[A commenter on that answer](#) pointed out that he detected some stutter, even on decent hardware.

This chapter reviews the steps that were taken to determine if we really are doing things incorrectly, what specifically we are doing wrong, and what can be done to fix it.

### Are We Janky?

In the eyes of this book's author, the three-pane implementation presented in the chapter on animators was perfectly reasonable on good hardware.

There are two lessons to take from this:

1. It is better to come up with an objective definition for “jank” and test to see if your code meets that definition at various points
2. The author of this book is very tolerant of janky user interfaces

The results shown in [the chapter on CPU measurement](#) for the `gfxinfo` and `systrace` tools comes from the three-pane demo code. The `gfxinfo` and the `systrace` results both point to the three-pane demo spending too much time doing work and therefore dropping some number of frames. This lines up with the visual report, and indicates that we have some work to do to try to improve matters.

### Finding the Source of the Jank

Just because we know that we are janky does not mean that we have any idea what to do about it. We need to conduct some further analysis to determine where, exactly, our jank is coming from.

#### Traceview

One thing that we can do to help further refine the source of our trouble is to use Traceview. As outlined in [the section on Traceview](#), Traceview reports how many calls were made of various methods in our code (and in the framework code) and how much time was spent there.

Here are some of the results from a Traceview run on the three-pane demo on a Nexus 7:

## FINDING AND ELIMINATING JANK

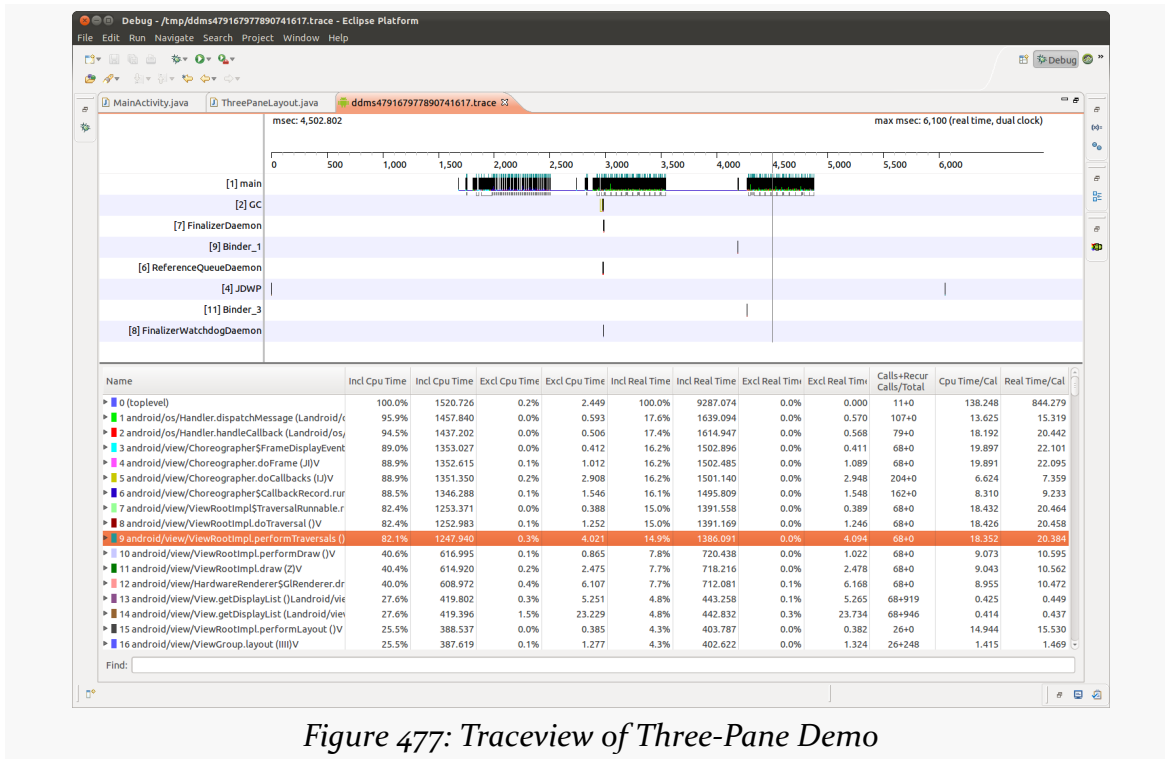


Figure 477: Traceview of Three-Pane Demo

We see that 88.9% of our CPU time is spent in `doFrame()` on `Choreographer` and the calls triggered from it. `doFrame()` is a private method which, as the name suggests, performs the drawing, processing, and executing of a single frame's worth of rendering. More importantly, we see that `doFrame()` was called 68 times during our test run, meaning that our UI changed 68 times during the ~3 seconds of activity during our trace.

Further down the table, we see that `layout()` on `ViewGroup` was called 26 times directly (and 248 more times via recursion), contributing about 25% of the time consumed by `doFrame()`. Since `layout()` is called on less than half of the `doFrame()` calls, the time consumed by `layout()` makes up a fairly significant portion of the `doFrame()` time during those 26 frames.

More importantly, `layout()` is something that we trigger. It implies that we have made some change to our UI content that requires a layout pass of some `ViewGroup`.

Having a layout pass on occasion is perfectly normal, particularly in response to user input. A `layout()` might be triggered by the user tapping on a row in one of our `ListView`s, for example. But we are not doing 26 user input events in our test —

all we are doing is tapping one time each on a pair of `ListView` rows, then pressing the BACK button. This implies that something else in our code is causing `layout()` to be needed.

Unfortunately, at this point, Traceview does not help much, because the calls to `layout()` are asynchronous with respect to our own code, so it will not be all that obvious where the extra calls are coming from. This is where we need some expert help, as we will see [later in this chapter](#).

### Overdraw

Another common source of jank is overdraw. Overdraw refers to the act of painting the same pixel several times, due to overlapping components. For example:

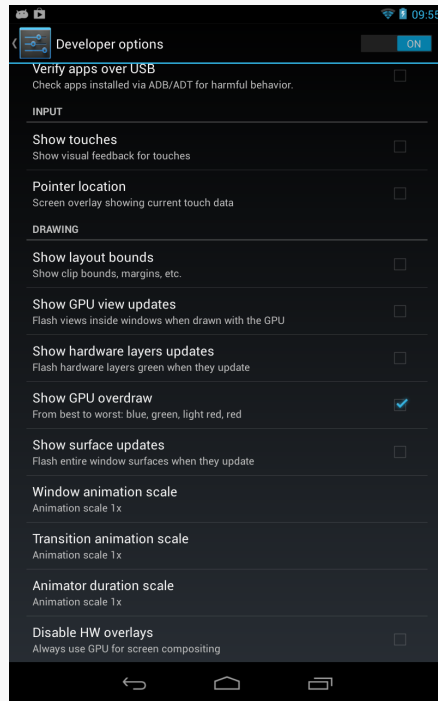
- The activity window itself has a background
- You have a container that fills the activity's content, such as a `ListView`, which has a background
- You have children in that container with backgrounds (row), who have their own children with backgrounds and, eventually, content (widgets like `ImageView` and `TextView`)

Places where there is overlap, the OS might set the color of a pixel several times per frame, wasting time.

The easiest way to track down overdraw is to use the “Show GPU overdraw” option in the Developer Options portion of the Settings app:

## FINDING AND ELIMINATING JANK

---



*Figure 478: Nexus 7 Developer Options, with “Show GPU overdraw”*

This option is only available on Android 4.2 and higher.

When you enable this option, then restart your app’s process (if it was already running), Android will shade pixels that are overdrawn:

- Blue for pixels that are drawn twice
- Green for pixels that are drawn three times
- Pink for pixels that are drawn four times
- Red for pixels that are drawn five or more times

In short: pink and red are bad. Green and blue are OK, though if you have large patches of either shade, you might consider trying to see if there’s a way to get rid of the overdraw.

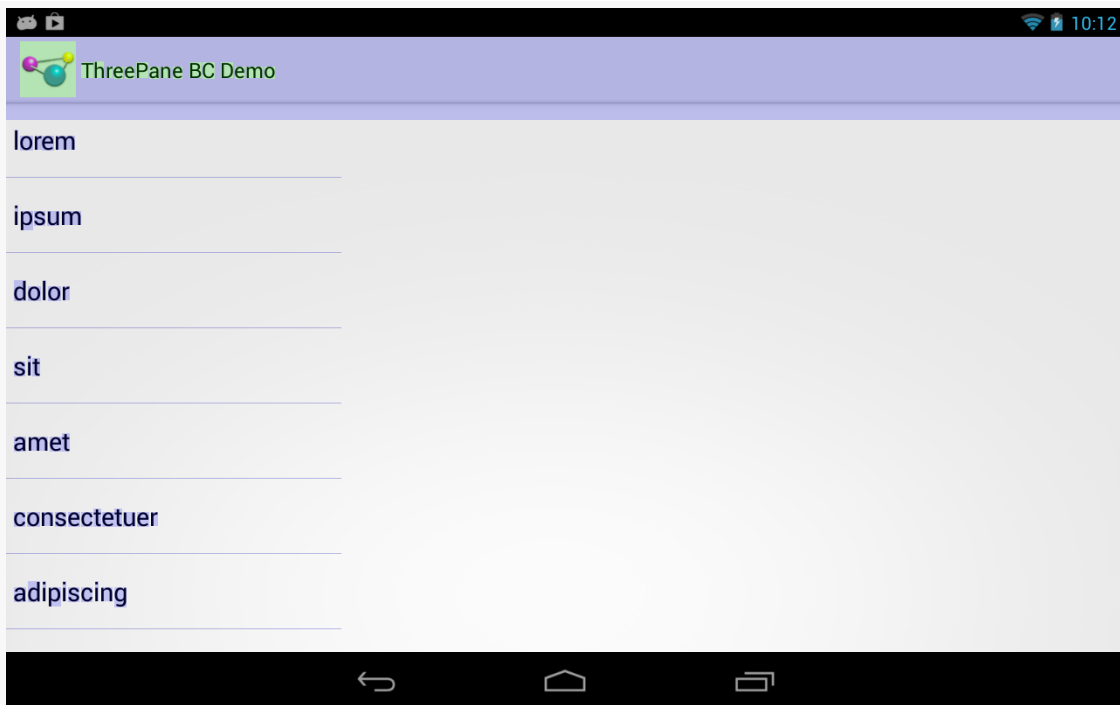
Of course, the fact that these are shades applied to existing pixel colors may make it a bit difficult to tell exactly where the overdraw is occurring. For example, a red portion of your UI might be red from overdraw... or it might be red because you made it red. Temporarily changing your color scheme to something else (e.g., yellow) will help distinguish what is overdraw and what is just the natural UI coloration.



## FINDING AND ELIMINATING JANK

---

If you enable this option on a Nexus 7 and run the three-pane demo, you will see very little blue or green (beyond the normal blue of the activated state of our ListView rows), and virtually no red:



*Figure 479: Three-Pane Demo, As Initially Launched, Showing Overdraw*

## FINDING AND ELIMINATING JANK



Figure 480: Three-Pane Demo, Left and Middle Panes, Showing Overdraw

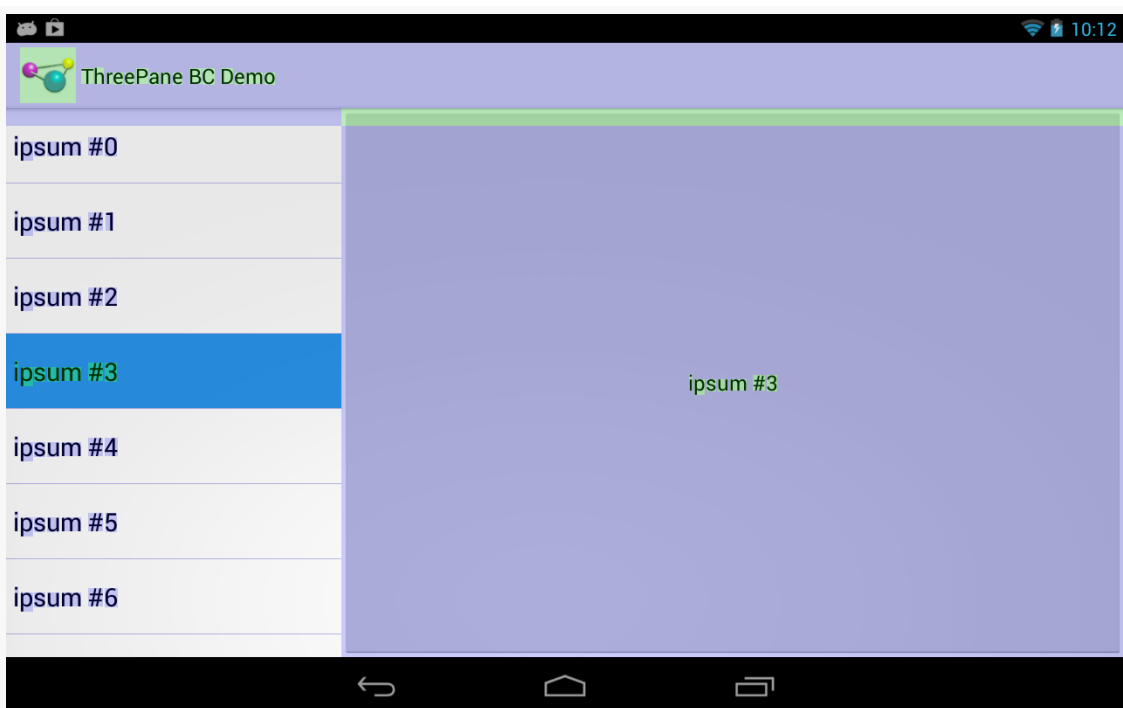


Figure 481: Three-Pane Demo, Middle and Right Panes, Showing Overdraw

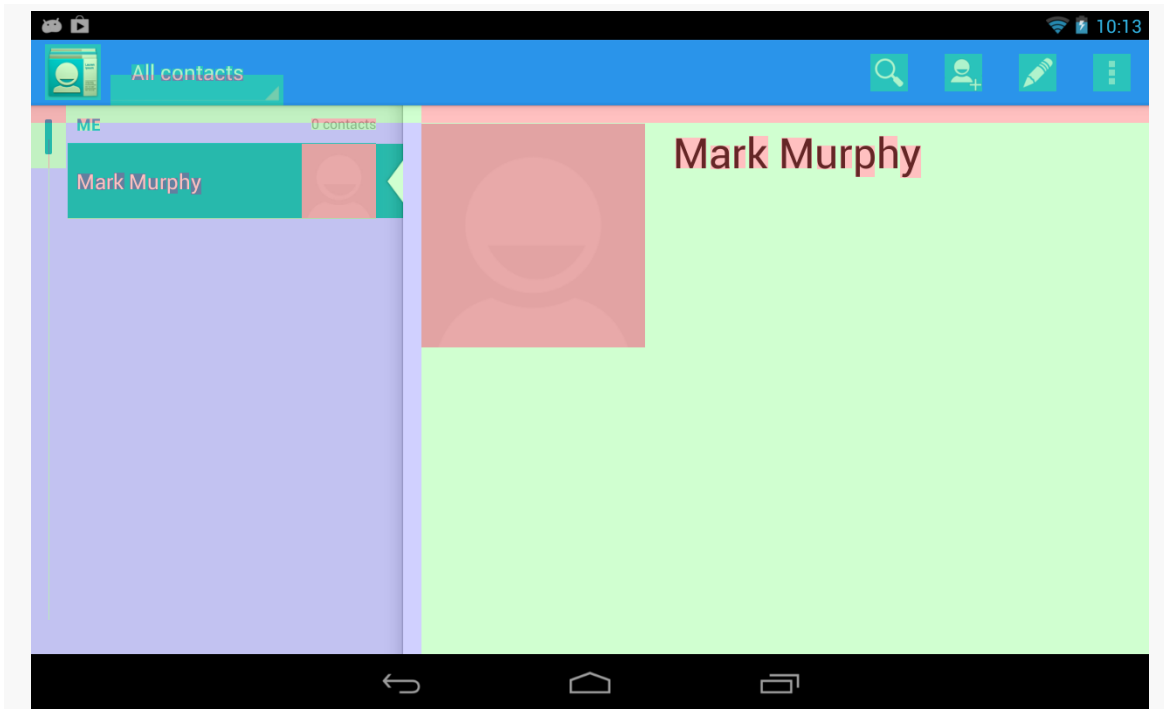
## FINDING AND ELIMINATING JANK



Figure 482: Three-Pane Demo, Left and Middle Panes Via BACK, Showing Overdraw

On the other hand, bringing up the Contacts app on the same Nexus 7 shows significantly more overdraw:

## FINDING AND ELIMINATING JANK



*Figure 483: Contacts App, Showing Overdraw*

The good news is that our app is not suffering performance problems due to overdraw.

The bad news is that the Contacts app is.

The good news is that if you are reading this, you are probably not responsible for maintaining the Contacts app.

The Contacts app's major problems come from the contact photos, or placeholders as seen here. Either the `ImageView` has a background, or the `ImageView` fills some container with a background. For example, the `ImageView` might be in some container with a background to provide a bevel effect around the image. Making the portion of the background that is behind the `ImageView` be transparent will eliminate the overdraw.

Note: some GPU architectures can automatically fix overdraw in select places, while others cannot. Notably, the Tegra 3 cannot. Hence, the Tegra 3 is a good test platform for using this overdraw-detection feature of Android.

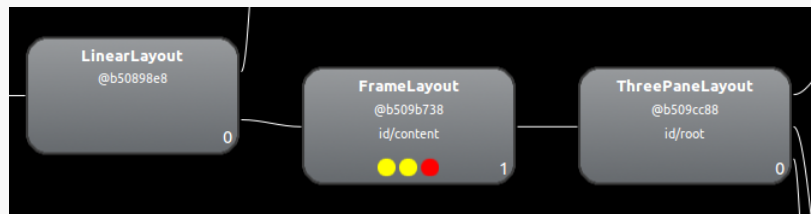
### Extraneous Views

Another related source of jank is having too many extraneous views. Each widget and container contributes to the cost of drawing the overall UI, so having extraneous views adds overhead.

Perhaps the most common scenario for extraneous views is the single-child container. If a container will only ever hold one child, perhaps you can get rid of that container. Not only will this speed up execution at runtime, but it can help [avoid running out of stack space](#).

One likely way to find these extraneous views is to bring up your user interface [in Hierarchy View on an emulator](#) (or possibly on a device by [using ViewServer](#)). In particular, single-child containers are fairly obvious — look for bubbles that have just one child bubble on the right.

There are two such cases in the UI for our three-pane demo, though neither are our fault.

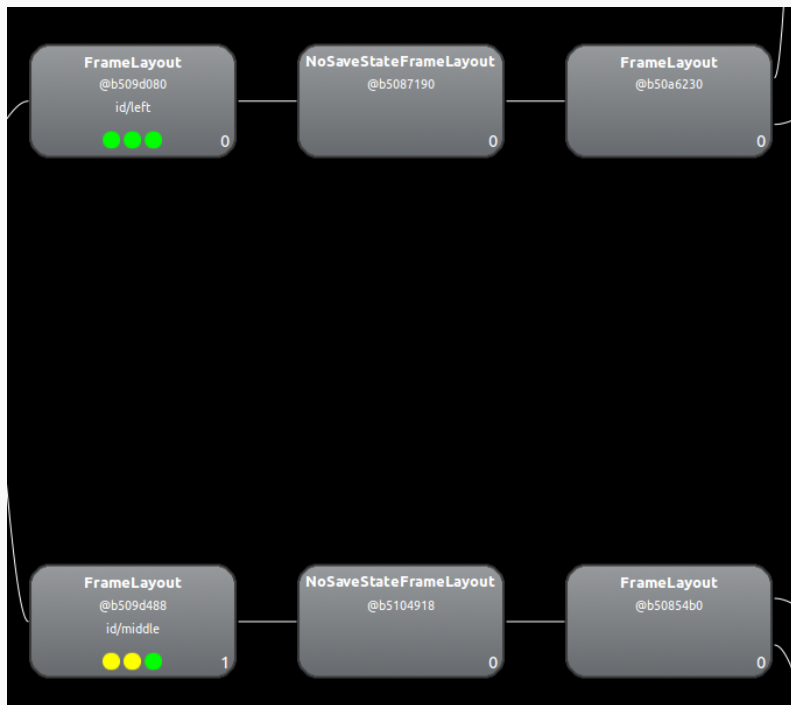


*Figure 484: Single-Child FrameLayout in Three-Pane Demo, from Hierarchy View*

Here, we have a `FrameLayout` holding onto just one child, our `ThreePaneLayout` custom view. We set up `ThreePaneLayout` as being our activity's content view. The “content view” of an activity is poured into a `FrameLayout`, supplied by the Android framework — that is the `FrameLayout` seen in Hierarchy View. We have no good way to get rid of this `FrameLayout`. Fortunately, `FrameLayout` is a very cheap container, in terms of runtime execution speed.

## FINDING AND ELIMINATING JANK

---



*Figure 485: More Single-Child Containers in Three-Pane Demo, from Hierarchy View*

Here, we see that our left and middle FrameLayout containers, for our left and middle panes, each contain one child, a NoSaveStateFrameLayout, which in turn each hold one child, a FrameLayout. These containers are added by ListFragment, not directly by our code. A ListFragment is surprisingly complex, adding several widgets and containers beyond the ListView itself:

## FINDING AND ELIMINATING JANK

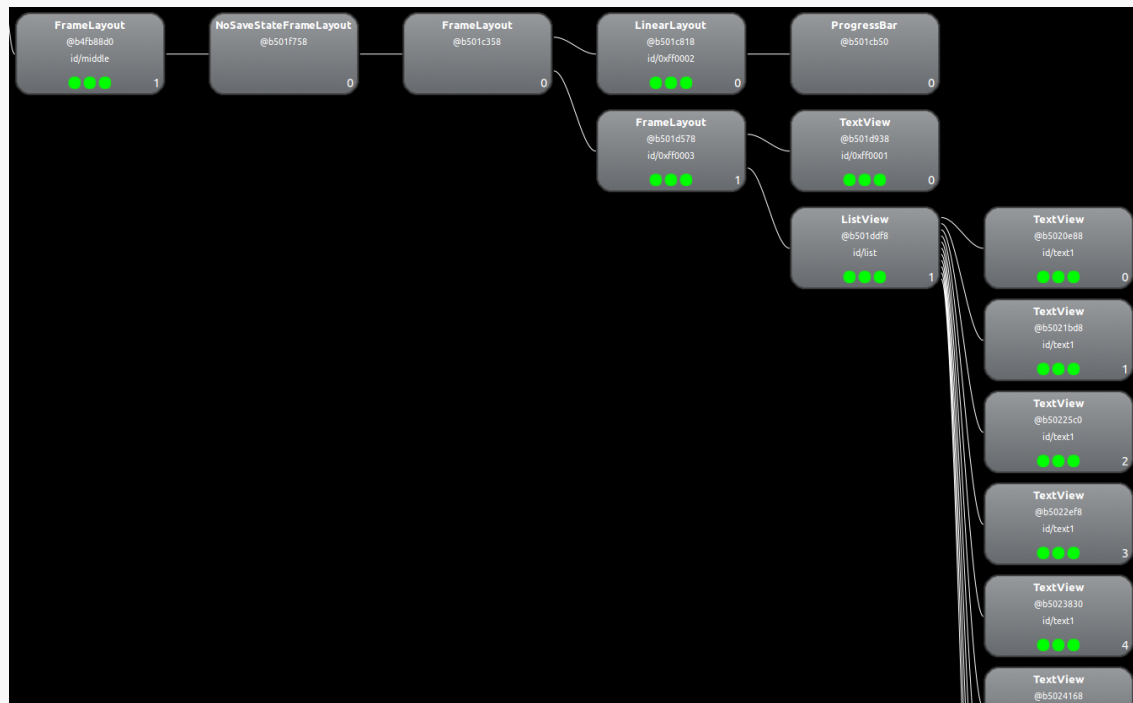


Figure 486: Contents of a ListFragment, from Hierarchy View

Short of writing our own fragment for holding a `ListView`, there is nothing we can do about these extraneous views.

### Conclusion: Too Many `layout()` Calls?

Given that overdraw does not seem to be a problem and that we have few extraneous views under our control, it would seem that perhaps we should return our attention to the extra `layout()` calls. While trying to get rid of the `ListFragment` extraneous views would make those `layout()` calls incrementally cheaper, we will get more value by getting rid of the unnecessary calls in the first place, if indeed they are unnecessary.

### Where Things Went Wrong

Of course, it doesn't hurt to call in an expert, to try to confirm exactly what is going on.

Chet Haase — Google engineer on Android, [celebrated book author](#), and part-time comedian – [chimed in with an answer](#) to a StackOverflow question about this

## FINDING AND ELIMINATING JANK

---

three-pane animation, asked by the person who commented about the dropped frames on the original StackOverflow question.

The key statement from his answer was:

Sliding things around is fine (translationX/Y), fading things in/out is good (alpha), but actually laying things out on every frame? Just say no.

Specifically, he is referring to our use of `ObjectAnimator` to change the width of the middle pane as we show and hide the right pane. Each time we change the width of the middle pane, we trigger a `layout()` call, to reposition the child widgets within that pane as needed. Our animations are adding ~20 `layout()` calls, introducing overhead that is pushing us over the per-frame limit on the Nexus 7.

## Removing the Jank

To remove the jank, we need to remove the `ObjectAnimator` changing the width of the middle pane on the fly. You can see the results of this in the [Jank/ThreePaneBC](#) sample app.

Now, our `showLeft()` and `hideLeft()` methods immediately change the width of the middle pane, rather than arranging its animation:

```
public void hideLeft() {
    if (leftWidth == -1) {
        leftWidth=left.getWidth();
        middleWidthNormal=middle.getWidth();
        resetWidget(left, leftWidth);
        resetWidget(middle, middleWidthNormal);
        resetWidget(right, middleWidthNormal);
        requestLayout();
    }

    translateWidgets(-1 * leftWidth, left, middle, right);
    setMiddleWidth(leftWidth);
}

public void showLeft() {
    translateWidgets(leftWidth, left, middle, right);
    setMiddleWidth(middleWidthNormal);
}

private void setMiddleWidth(int value) {
    middle.getLayoutParams().width=value;
    requestLayout();
}
```

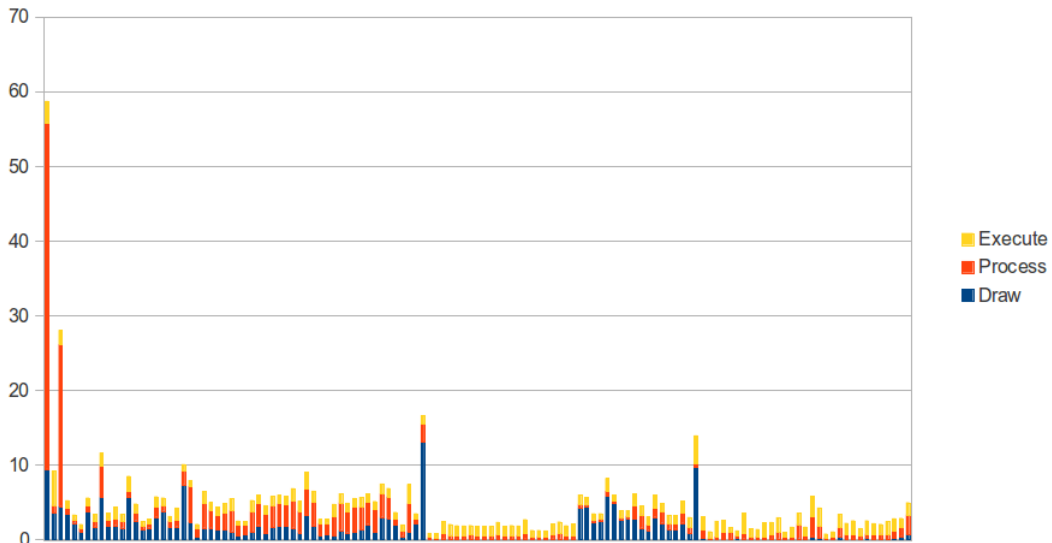


## FINDING AND ELIMINATING JANK

---

This does not provide nearly as good of a UI as the original. There are probably ways to improve upon the revised jank-free implementation. Lacking that, it is up to you to decide if the amount of jank found in the original implementation is worth the improved animation or not.

What we can say is that the revised solution does reduce the jank, as seen in this `gfxinfo` output:



# Issues with Bandwidth

---

As anyone who owned an Apple Newton or Palm V PDA back in the 1990's knows, handheld devices have been around for quite some time. For a very long time, they were a niche product, associated with geeks, nerds, and the occasional business executive.

Internet access changed all of that.

Blackberry for enterprise messaging — an outgrowth of its original two-way paging approach — blazed part of the trail, but the concept “crossed the chasm” to ordinary people with the advent of the iPhone, Android devices, and similar equipment.

Therefore, it is not terribly surprising when Android developers want to add Internet capabilities to their apps. To the contrary, it is almost unusual when you encounter an app that does *not* want to use the Internet for something or another.

However, mobile Internet access inherits all of the classic problems of Internet access (e.g., “server not found”) and adds new and exciting challenges, all of which can leave a developer with an app that has performance issues.

## Prerequisites

Understanding this chapter requires that you have read the core chapters and understand how Android apps are set up and operate.

## You're Using Too Much of the Slow Stuff

To paraphrase America's Founding Fathers, "all Internet connections are not created equal".

One form of inequality is speed. Different classes of connection have different theoretical upper bounds. WiMAX and other "4G" connections are theoretically faster than 3G connections, which are theoretically faster than 2G or EDGE connections. WiFi — typically 802.11g in today's devices — is theoretically ridiculously fast though it is typically limited by the ISP connection, and ISP connections can run the gamut from really fast to merely good.

However, "theoretical" bounds tend to run afoul of reality. There are plenty of places where high-speed mobile data connections are non-existent, despite what the carriers' coverage maps claim. 2G mobile data works, but is not especially speedy. This layers on top of the typical Internet congestion issues, along with typically transitory problems (e.g., trying to get connectivity while attending a technology conference keynote presentation).

Hence, what runs quickly in the lab may run much more slowly in users' hands.

If you followed the instructions in previous chapters on CPU bottlenecks, the limited bandwidth will not cause your UI to become "janky", in that it will be responsive to touches and taps. However, poor connectivity will mean that you are simply slow to respond to user requests. For example, clicking the "check for new email" menu button has no immediate effect. If you feel that you need a splash screen or progress indicator to tell the user that "we are really checking for new email, honest", then you know that your Internet access is slower than is ideal.

Obviously, some of this is unavoidable. However, the objective of the chapters in this part of the book is to give you an idea of ways to reduce your bandwidth consumption, making those delays be that much less annoying for your users.

## You're Using Too Much of the Expensive Stuff

Mobile data tends to come with more strings attached than does WiFi.

In the US, it used to be that mobile data connections included unlimited usage. Now, at best, a mobile data plan has "unlimited" usage for a curious definition of the term "unlimited". More and more carriers are moving towards a hard cap — go above

the cap, and you either cannot use more bandwidth, have your speeds curtailed, or pay significantly for additional bandwidth.

Outside of the US, the “pay significantly for bandwidth” approach is fairly typical. So-called “metered” data plans simply charge you such-and-so per MB or GB of bandwidth.

And, to top it off, roaming almost always is a metered plan. So, a US resident traveling overseas, even with a SIM and phone that supports international usage, would pay a ridiculous sum for bandwidth. Stories of phone bills in the tens of thousands of dollars abound, where people simply used their phone as they normally would when they were outside of their home network.

Hence, if you use a fair bit of bandwidth, it would be really nice if you offered users means to consume less of it when they are on mobile data compared to WiFi (which is typically unmetered). You could elect to poll your server less frequently, for example, giving the users the ability to specify separate polling periods depending on which type of connection they have.

And, of course, there are other “costs” for using bandwidth besides direct monetary costs. For example, downloading data over a slower mobile data connection may consume more power than downloading the same data over WiFi — while the WiFi radio might consume additional power, the time difference might account for more power consumption, if the CPU could be powered down for the rest of that time.

These chapters will show you how you can react to changes in connectivity and approaches for how to use that information to reduce costs for the user.

## **You’re Using Too Much of Somebody Else’s Stuff**

It is easy for developers to think that they alone are using a user’s device. Alas, this is infrequently the case, particularly when it comes to background Internet access.

While your application is busily downloading stuff, some other application might be busily downloading stuff. In principle, this should not be an issue, as multiple applications can access the Internet simultaneously. However, bandwidth can become an issue. If you are in the background, and the other application is in the foreground, the user might notice that bandwidth is an issue. For example, users might be unhappy if your downloads are impeding their ability to watch streaming video, or play their favorite Android-based MMORPG, or whatever.

A polite Android application will test to see whether the foreground application is heavily using the Internet and will curtail its own Internet use while that is going on. This chapter will help you learn how to make that determination and how to respond.

### **You're Using Too Much... And There Is None**

Not only might location dictate how much bandwidth you have, but whether you have any bandwidth at all.

While some people think that the entire planet has connectivity, reality once again dictates otherwise. Major metropolitan areas have connectivity... at least, so long as the carriers have not melted down due to overuse, as AT&T tended to do during the early months of the iPhone Invasion. Outlying areas are much more hit-or-miss. Voice is sometimes a challenge, let alone data. And it only *seems* as though there is a Starbucks every 100 meters, which might actually provide blanket WiFi coverage.

Then, of course, there are planes (most do not offer in-flight WiFi at this time), international travel without an international-capable phone plan, and so on.

Some Android applications have the potential to still offer near-complete functionality despite this, with a bit of user assistance. For example, Google Maps for Android now has an offline caching feature, which will download data for a 10-mile radius from a given point, for use while the device is otherwise offline.

Here, the issue becomes less one of bandwidth (other than detecting that you have no connection) and more one of caching and storage. The space-related issues that these techniques can raise will be covered elsewhere in this book.

# Focus On: TrafficStats

---

To be able to have more intelligent code — code that can adapt to Internet activity on the device — Android offers the `TrafficStats` class. This class really is a gateway to a block of native code that reports on traffic usage for the entire device and per-application, for both received and transmitted data. This chapter will examine how you can access `TrafficStats` and interpret its data.

## Prerequisites

Understanding this chapter requires that you have read the core chapters and understand how Android apps are set up and operate.

## TrafficStats Basics

The `TrafficStats` class is not designed to be instantiated — you will not be invoking a constructor by calling `new TrafficStats()` or something like that. Rather, `TrafficStats` is merely a collection of static methods, mapped to native code, that provide access to point-in-time traffic values. No special permissions are needed to use any of these methods. Most of the methods were added in API Level 8 and therefore should be callable on most Android devices in use today.

## Device Statistics

If you are interested in overall traffic, you will probably care most about the `getTotalRxBytes()` and `getTotalTxBytes()` on `TrafficStats`. These methods return received and transmitted traffic, respectively, measured in bytes.

You also have:

1. `getTotalRxPackets()` and `getTotalTxPackets()`, if for your case measuring IP packets is a better measure than bytes
2. `getMobileRxBytes()` and `getMobileTxBytes()`, which return the traffic going over mobile data (also included in the total)
3. `getMobileRxPackets()` and `getMobileTxPackets()`, which are the packet counts for the mobile data connection

### Per-Application Statistics

Technically, `TrafficStats` does not provide per-application traffic statistics. Rather, it provides per-UID traffic statistics. In most cases, the UID (user ID) of an application is unique, and therefore per-UID statistics map to per-application statistics. However, it is possible for multiple applications to share a single UID (e.g., via the `android:sharedUserId` manifest attribute) — in this case, `TrafficStats` would appear to provide traffic data for all applications sharing that UID.

There are per-UID equivalents of the first four methods listed in the previous section, replacing “Total” with “Uid”. So, to find out overall traffic for an application, you could use `getUidRxBytes()` and `getUidTxBytes()`. However, these are the only two UID-specific methods that were implemented in API Level 8. Equivalents of the others (e.g., `getUidRxPackets()`) were added in API Level 12. API Level 12 also added some TCP-specific methods (e.g., `getUidTcpTxBytes()`). Note, though, that the mobile-only method are only available at the device level; there are no UID-specific versions of those methods.

### Interpreting the Results

You will get one of two types of return value from these methods.

In theory, you will get the value the method calls for (e.g., number of bytes, number of packets). The documentation does not state the time period for that value, so while it is possible that it is really “number of bytes since the device was booted”, we do not know that for certain. Hence, `TrafficStats` results should be used for comparison purposes, either comparing the same value over time or comparing multiple values at the same time. For example, to measure bandwidth consumption, you will need to record the `TrafficStats` values at one point in time, then again later — the difference between them represents the consumed bandwidth during that period of time.

In practice, while the “total” methods seem reliable, the per-UID methods often return -1. The official explanation for this is that the particular traffic metric is unavailable on that device, and this does explain some of the -1 values that are returned. For example, a Nexus One running Android 2.3 returns -1 for all the per-UID methods, while a Nexus S running Android 2.3 will return a positive value for *some* UIDs. It is unclear what the other -1 values mean. Two possible meanings are:

1. There has been no traffic of that type on that UID since boot, or
2. You do not have permission to know the traffic of that type on that UID

Hence, the per-UID values are a bit “hit or miss”, which you will need to take into account.

## Example: TrafficMonitor

To illustrate the use of `TrafficStats` methods and analysis, let us walk through the code associated with the [Bandwidth/TrafficMonitor](#) sample application. This is a simple activity that records a snapshot of the current traffic levels on startup, then again whenever you tap a button. On-screen, it will display the current value, previous value, and difference (“delta”) between them. In LogCat, it will dump the same information on a per-UID basis.

### TrafficRecord

It would have been nice if `TrafficStats` were indeed an object that you would instantiate, that captured the traffic values at that moment in time. Alas, that is not how it was written, so we need to do that ourselves. In the `TrafficMonitor` project, this job is delegated to a `TrafficRecord` class:

```
package com.commonware.android.tuning.traffic;

import android.net.TrafficStats;

class TrafficRecord {
    long tx=0;
    long rx=0;
    String tag=null;

    TrafficRecord() {
        tx=TrafficStats.getTotalTxBytes();
        rx=TrafficStats.getTotalRxBytes();
    }

    TrafficRecord(int uid, String tag) {
```



```
    tx=TrafficStats.getUidTxBytes(uid);
    rx=TrafficStats.getUidRxBytes(uid);
    this.tag=tag;
}
}
```

There are two separate constructors, one for the total case and one for the per-UID case. The total case just logs `getTotalRxBytes()` and `getTotalTxBytes()`, while the per-UID case uses `getUidRxBytes()` and `getUidTxBytes()`. The per-UID case also stores a “tag”, which is simply a `String` identifying the UID for this record — as you will see, `TrafficMonitor` uses this for a package name.

### TrafficSnapshot

An individual `TrafficRecord`, though, is insufficient to completely capture the traffic figures at a moment in time. We need a collection of `TrafficRecord` objects, one for the device (“total”) and one per running UID. The work to collect all of that is handled by a `TrafficSnapshot` class:

```
package com.commonware.android.tuning.traffic;

import java.util.HashMap;
import android.content.Context;
import android.content.pm.ApplicationInfo;

class TrafficSnapshot {
    TrafficRecord device=null;
    HashMap<Integer, TrafficRecord> apps=
        new HashMap<Integer, TrafficRecord>();

    TrafficSnapshot(Context ctxt) {
        device=new TrafficRecord();

        HashMap<Integer, String> appNames=new HashMap<Integer, String>();

        for (ApplicationInfo app :
            ctxt.getPackageManager().getInstalledApplications(0)) {
            appNames.put(app.uid, app.packageName);
        }

        for (Integer uid : appNames.keySet()) {
            apps.put(uid, new TrafficRecord(uid, appNames.get(uid)));
        }
    }
}
```

The constructor uses `PackageManager` to iterate over all installed applications and builds up a `HashMap`, mapping the UID to a `TrafficRecord` for that UID, tagged with

the application package name (e.g., `com.commonware.android.tuning.traffic`). It also creates one `TrafficRecord` for the device as a whole.

### TrafficMonitorActivity

`TrafficMonitorActivity` is what creates and uses `TrafficSnapshot` objects. This is a fairly conventional activity with a `TableLayout`-based UI:

```
<?xml version="1.0" encoding="utf-8"?>
<TableLayout xmlns:android="http://schemas.android.com/apk/res/android"
    android:id="@+id/table"
    android:layout_width="match_parent"
    android:layout_height="wrap_content">

    <Button
        android:onClick="takeSnapshot"
        android:text="Take Snapshot"/>

    <TableRow>

        <TextView
            android:layout_column="1"
            android:layout_gravity="right"
            android:text="@string/received"
            android:textSize="20sp"/>

        <TextView
            android:layout_gravity="right"
            android:text="@string/sent"
            android:textSize="20sp"/>
    </TableRow>

    <TableRow>

        <TextView
            android:layout_marginRight="@dimen/margin_right"
            android:gravity="right"
            android:text="@string/latest"
            android:textSize="20sp"
            android:textStyle="bold"/>

        <TextView
            android:id="@+id/latest_rx"
            android:layout_marginRight="@dimen/margin_right"
            android:gravity="right"
            android:textSize="20sp"/>

        <TextView
            android:id="@+id/latest_tx"
            android:gravity="right"
            android:textSize="20sp"/>
    </TableRow>
</TableLayout>
```

```
</TableRow>
<TableRow>
    <TextView
        android:layout_marginRight="@dimen/margin_right"
        android:gravity="right"
        android:text="@string/previous"
        android:textSize="20sp"
        android:textStyle="bold"/>
    <TextView
        android:id="@+id/previous_rx"
        android:layout_marginRight="@dimen/margin_right"
        android:gravity="right"
        android:textSize="20sp"/>
    <TextView
        android:id="@+id/previous_tx"
        android:gravity="right"
        android:textSize="20sp"/>
</TableRow>
<TableRow>
    <TextView
        android:layout_marginRight="@dimen/margin_right"
        android:gravity="right"
        android:text="@string/delta"
        android:textSize="20sp"
        android:textStyle="bold"/>
    <TextView
        android:id="@+id/delta_rx"
        android:layout_marginRight="@dimen/margin_right"
        android:gravity="right"
        android:textSize="20sp"/>
    <TextView
        android:id="@+id/delta_tx"
        android:gravity="right"
        android:textSize="20sp"/>
</TableRow>
</TableLayout>
```

The activity implementation consists of three methods. There is your typical `onCreate()` implementation, where we initialize the UI, get our hands on the `TextView` widgets for output, and take the initial snapshot:

```
@Override
public void onCreate(Bundle savedInstanceState) {
    super.onCreate(savedInstanceState);
```

## FOCUS ON: TRAFFICSTATS

---

```
setContentView(R.layout.main);

latest_rx=(TextView)findViewById(R.id.latest_rx);
latest_tx=(TextView)findViewById(R.id.latest_tx);
previous_rx=(TextView)findViewById(R.id.previous_rx);
previous_tx=(TextView)findViewById(R.id.previous_tx);
delta_rx=(TextView)findViewById(R.id.delta_rx);
delta_tx=(TextView)findViewById(R.id.delta_tx);

takeSnapshot(null);
}
```

The `takeSnapshot()` method creates a new `TrafficSnapshot` (held in a latest data member) after moving the last `TrafficSnapshot` to a previous data member. It then updates the `TextView` widgets for the latest data and, if the previous data member is not null, also for the previous snapshot and the difference between them. This alone is sufficient to update the UI, but we also want to log per-UID data to LogCat:

```
public void takeSnapshot(View v) {
    previous=latest;
    latest=new TrafficSnapshot(this);

    latest_rx.setText(String.valueOf(latest.device.rx));
    latest_tx.setText(String.valueOf(latest.device.tx));

    if (previous!=null) {
        previous_rx.setText(String.valueOf(previous.device.rx));
        previous_tx.setText(String.valueOf(previous.device.tx));

        delta_rx.setText(String.valueOf(latest.device.rx-previous.device.rx));
        delta_tx.setText(String.valueOf(latest.device.tx-previous.device.tx));
    }

    ArrayList<String> log=new ArrayList<String>();
    HashSet<Integer> intersection=new HashSet<Integer>(latest.apps.keySet());

    if (previous!=null) {
        intersection.retainAll(previous.apps.keySet());
    }

    for (Integer uid : intersection) {
        TrafficRecord latest_rec=latest.apps.get(uid);
        TrafficRecord previous_rec=
            (previous==null ? null : previous.apps.get(uid));

        emitLog(latest_rec.tag, latest_rec, previous_rec, log);
    }

    Collections.sort(log);

    for (String row : log) {
        Log.d("TrafficMonitor", row);
    }
}
```

## FOCUS ON: TRAFFICSTATS

---

```
}  
}
```

One possible problem with the snapshot system is that the process list may change between snapshots. One simple way to address this is to only log to LogCat data where the application's UID exists in both the previous and latest snapshots. Hence, `takeSnapshot()` uses a `HashSet` and `retainAll()` to determine which UIDs exist in both snapshots. For each of those, we call an `emitLog()` method to record the data to an `ArrayList`, which is then sorted and dumped to LogCat.

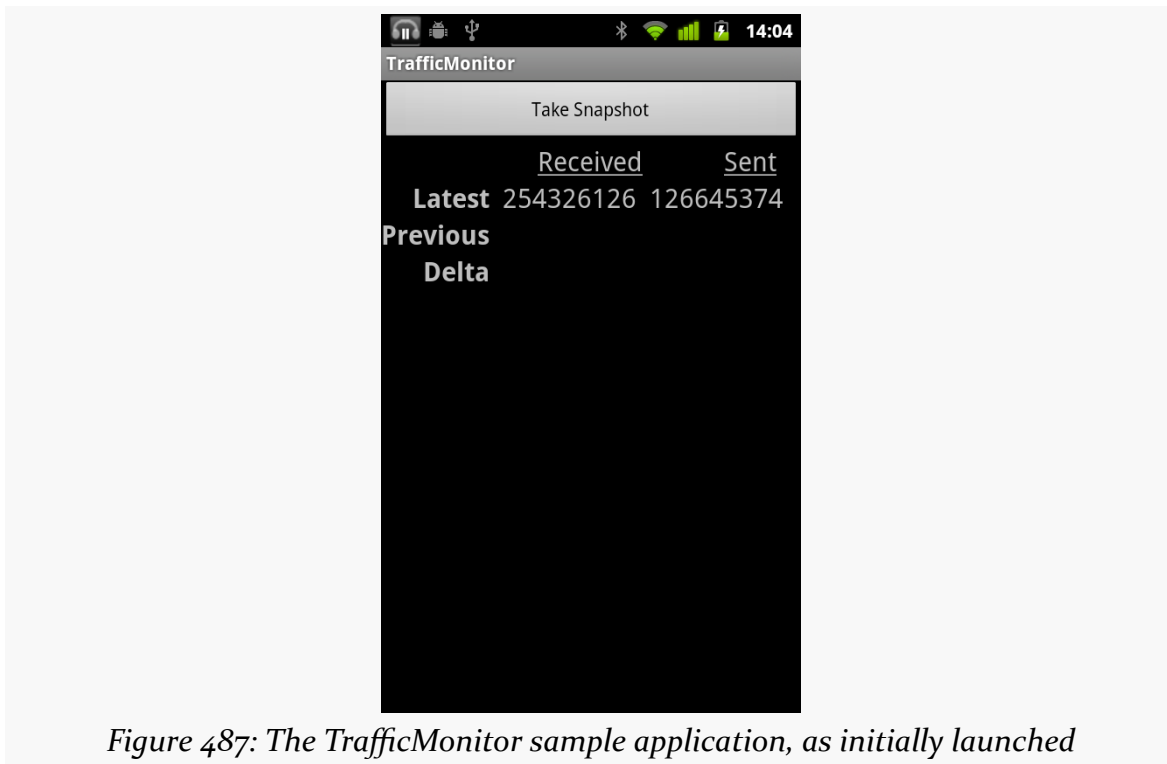
The `emitLog()` method builds up a line with the package name and bandwidth consumption information, assuming that there is bandwidth to report (i.e., we have a value other than -1):

```
private void emitLog(CharSequence name, TrafficRecord latest_rec,  
                    TrafficRecord previous_rec,  
                    ArrayList<String> rows) {  
    if (latest_rec.rx>-1 || latest_rec.tx>-1) {  
        StringBuilder buf=new StringBuilder(name);  
  
        buf.append("=");  
        buf.append(String.valueOf(latest_rec.rx));  
        buf.append(" received");  
  
        if (previous_rec!=null) {  
            buf.append(" (delta=");  
            buf.append(String.valueOf(latest_rec.rx-previous_rec.rx));  
            buf.append(")");  
        }  
  
        buf.append(", ");  
        buf.append(String.valueOf(latest_rec.tx));  
        buf.append(" sent");  
  
        if (previous_rec!=null) {  
            buf.append(" (delta=");  
            buf.append(String.valueOf(latest_rec.tx-previous_rec.tx));  
            buf.append(")");  
        }  
  
        rows.add(buf.toString());  
    }  
}
```

Since the lines created by `emitLog()` start with the package name, and since we are sorting those before dumping them to LogCat, they appear in LogCat in sorted order by package name.

## Using TrafficMonitor

Running the activity gives you the initial received and sent counts (in bytes):



*Figure 487: The TrafficMonitor sample application, as initially launched*

Tapping Take Snapshot grabs a second snapshot and compares the two:

## FOCUS ON: TRAFFICSTATS



Also, LogCat will show how much was used by various apps:

```
08-15 14:05:10.128: DEBUG/TrafficMonitor(10283):
com.amblingbooks.bookplayerpro=880 received (delta=0), 3200 sent (delta=0)
08-15 14:05:10.128: DEBUG/TrafficMonitor(10283): com.android.browser=19045241
received (delta=0), 2375847 sent (delta=0)
08-15 14:05:10.128: DEBUG/TrafficMonitor(10283):
com.android.providers.downloads=27884469 received (delta=0), 9126 sent (delta=0)
08-15 14:05:10.128: DEBUG/TrafficMonitor(10283):
com.android.providers.telephony=2328 received (delta=0), 4912 sent (delta=0)
08-15 14:05:10.128: DEBUG/TrafficMonitor(10283): com.android.vending=3271839
received (delta=0), 260626 sent (delta=0)
08-15 14:05:10.128: DEBUG/TrafficMonitor(10283): com.coair.mobile.android=887425
received (delta=0), 81366 sent (delta=0)
08-15 14:05:10.132: DEBUG/TrafficMonitor(10283):
com.commonware.android.browser1=262553 received (delta=0), 7286 sent (delta=0)
08-15 14:05:10.132: DEBUG/TrafficMonitor(10283): com.dropbox.android=6189833
received (delta=0), 4298 sent (delta=0)
08-15 14:05:10.132: DEBUG/TrafficMonitor(10283): com.evernote=3471398 received
(delta=0), 742178 sent (delta=0)
08-15 14:05:10.132: DEBUG/TrafficMonitor(10283):
com.google.android.apps.genie.geniewidget=358816 received (delta=0), 17775 sent
(delta=0)
08-15 14:05:10.132: DEBUG/TrafficMonitor(10283):
com.google.android.apps.googlevoice=103255 received (delta=0), 35559 sent
(delta=0)
```

## FOCUS ON: TRAFFICSTATS

---

```
08-15 14:05:10.132: DEBUG/TrafficMonitor(10283):
com.google.android.apps.maps=28440829 received (delta=0), 1230867 sent (delta=0)
08-15 14:05:10.132: DEBUG/TrafficMonitor(10283): com.google.android.backup=51320
received (delta=0), 49041 sent (delta=0)
08-15 14:05:10.132: DEBUG/TrafficMonitor(10283): com.google.android.gm=10915084
received (delta=0), 14428803 sent (delta=0)
08-15 14:05:10.132: DEBUG/TrafficMonitor(10283):
com.google.android.googlequicksearchbox=37817 received (delta=0), 12554 sent
(delta=0)
08-15 14:05:10.132: DEBUG/TrafficMonitor(10283):
com.google.android.syncadapters.contacts=1955990 received (delta=0), 714893 sent
(delta=0)
08-15 14:05:10.132: DEBUG/TrafficMonitor(10283):
com.google.android.voicesearch=67948 received (delta=0), 121908 sent (delta=0)
08-15 14:05:10.132: DEBUG/TrafficMonitor(10283): com.google.android.youtube=3128
received (delta=0), 2792 sent (delta=0)
08-15 14:05:10.132: DEBUG/TrafficMonitor(10283): com.howcast.android.app=2250407
received (delta=0), 26727 sent (delta=0)
08-15 14:05:10.132: DEBUG/TrafficMonitor(10283):
com.rememberthemilk.MobileRTM=6836605 received (delta=0), 2902904 sent (delta=0)
08-15 14:05:10.132: DEBUG/TrafficMonitor(10283): com.tripit=109499 received
(delta=0), 50060 sent (delta=0)
```

## Other Ways to Employ TrafficStats

Of course, there are more ways you could use TrafficStats than simply having an activity to report them on a button click. TrafficMonitor is merely a demonstration of using the class and providing a lightweight way to get value out of that data. Depending upon your application's operations, though, you may wish to consider using TrafficStats in other ways, in your production code or in your test suites.

### In Production

If your app is a bandwidth monitor, the need to use TrafficStats is obvious. However, even if your app does something else, you may wish to use TrafficStats to understand what is going on in terms of Internet access within your app or on the device as a whole.

For example, you might want to consider bandwidth consumption to be a metric worthy of including in the rest of the “analytics” you generate from your app. If you are using services like [Flurry](#) to monitor which activities get used and so on, you might consider also logging the amount of bandwidth your application consumes. This not only gives you much more “real world” data than you will be able to collect on your own, but it may give you ideas of how users are using your application beyond what the rest of your metrics are reporting.



Another possibility would be to include your app's bandwidth consumption in error logs reported via libraries like [ACRA](#). Just as device particulars can help identify certain bug report patterns, perhaps certain crashes of your app only occur when users are using a lot of bandwidth in your app, or using a lot of bandwidth elsewhere and perhaps choking your own app's Internet access.

The [chapter on bandwidth mitigation strategies](#) will also cover a number of uses of TrafficStats for real-time adjustment of your application logic.

### During Testing

You might consider adding TrafficStats-based bandwidth logging for your application in your test suites. While individual tests may or may not give you useful data, you may be able to draw trendlines over time to see if you are consuming more or less bandwidth than you used to. Take care to factor in that you may have changed the tests, in addition to changing the code that is being tested.

From a JUnit-based unit test suite, measuring bandwidth consumption is not especially hard. You can bake it into the `setUp()` and `tearDown()` methods of your test cases, either via inheritance or composition, and log the output to a file or LogCat.

From an external test engine, like [monkeyrunner](#) or [NativeDriver](#), recording bandwidth usage is more tricky, because your test code is not running on the device or emulator. You may have to include a `BroadcastReceiver` in your production code that will log bandwidth usage and trigger that code via the `am broadcast shell` command.

# Measuring Bandwidth Consumption

---

The first step towards addressing bandwidth concerns is to get a better picture of how much bandwidth you are actually consuming, when, and under what conditions. Only then will you be able to determine where your efforts need to be applied and whether those efforts are actually giving you positive results. This chapter will examine a handful of ways you can determine how much bandwidth you are really using in your application.

## Prerequisites

Understanding this chapter requires that you have read the core chapters and understand how Android apps are set up and operate.

## On-Device Measurement

Many times, you are best served by measuring your bandwidth consumption right on the device itself:

1. This is your only option for gathering bandwidth metrics from copies of your app in end users' hands, unless they invite you to their home or office and have you sniff on their personal network, which seems unlikely
2. This is your only option for gathering bandwidth metrics when you are using mobile data plans (e.g., 3G) instead of WiFi, since you probably do not control the wireless telecommunications infrastructure in your area
3. This is your simplest option for tying bandwidth metrics to events within your app or occurring on the device

4. This is your only option for using bandwidth metrics to adjust your application behavior in real time, in addition to using the metrics to learn how best to adjust your code in future updates to the app

Hence, in addition to perhaps other off-device techniques, you really should consider one of the on-device approaches outlined in the following sections.

### Yourself, via TrafficStats

The [preceding chapter](#) outlined how to use the `TrafficStats` class to collect metrics on the bandwidth consumed by applications (including yours) and for the device as a whole. This gives you the most flexibility, because you can write your own code to collect whatever portion of this data you need. It can address all of the bullets shown above, for example.

It is not perfect, though:

1. It requires you to write your own code, adding yet more work to your plate
2. Per-UID traffic data may or may not be available, depending upon the device

### Existing Android Applications

If you do not want to write code to use `TrafficStats`, there are various applications on the Play Store that can report that data to you, much along the lines of how `TrafficMonitor` does. Here are some notes about a few free ones tested by the author:

1. [Network Traffic Detail](#) (v. 1.3) works, but does not consider that bandwidth is only reported per UID, not per application. As a result, it reports the same traffic multiple times, one for each application sharing a UID.
2. [Traffic Monitor](#) (v. 2.4.2) advertises itself as an application, but does not put an icon in the launcher for it, forcing you to install an app widget instead in order to get to the actual application. While it reports device-level bandwidth, and it has a task manager, the task list does not report bandwidth for those tasks.
3. [Bandwidth Monitor](#) (v. 1.0.6) works and is perhaps incrementally easier to use than the other alternatives, though its touted bar chart of bandwidth consumption lacks any indicator of the value of the Y axis.

There are certainly others on the Market today and more will show up over time. For your own use, these sorts of apps may be very helpful. However, since you control

nothing over what is collected and how (and, in the case of some, even when it is collected), it may be difficult for you to get a solid grasp on where your code is consuming bandwidth this way.

There are also various apps that provide more in the way of packet-sniffing capability. However, these require you to root your phone and run the app with root privileges.

## Off-Device Measurement

The biggest limitation of `TrafficStats` is that it only gives you gross metrics: numbers of bytes, packets, and so on. Sometimes, that is not enough to help you understand why those bytes, packets, and so on are actually being sent or received. Sometimes, it would be nice to understand the traffic in more detail, from the ports and IP addresses to perhaps the actual data being transmitted. For obvious security reasons, this is not something an ordinary Android SDK application can do. However, there are techniques for accomplishing this, mostly for use over WiFi in your own home or office network. Some of these are outlined in the following sections.

### Wireshark

[Wireshark](#), formerly known as Ethereal, is perhaps the world's leading open source network traffic analyzer and packet inspector. Using it, you can learn in great detail what is going on with your local network. And, Android provides additional options for you to leverage Wireshark to make sense of application behavior. Wireshark is available for Linux, OS X, and Windows.

There is a lightly-documented `-tcpdump` switch available on the Android emulator. If you launch the emulator from the command line with that switch (plus `-avd` to identify the AVD file you want to use), all network access is dumped to your specified log file. You can then load that data into Wireshark for analysis, via File|Open from the main menu.

For example, here is a screenshot of Wireshark examining data from such an emulator dump file, in which the emulator was used to conduct a Google search:

## MEASURING BANDWIDTH CONSUMPTION

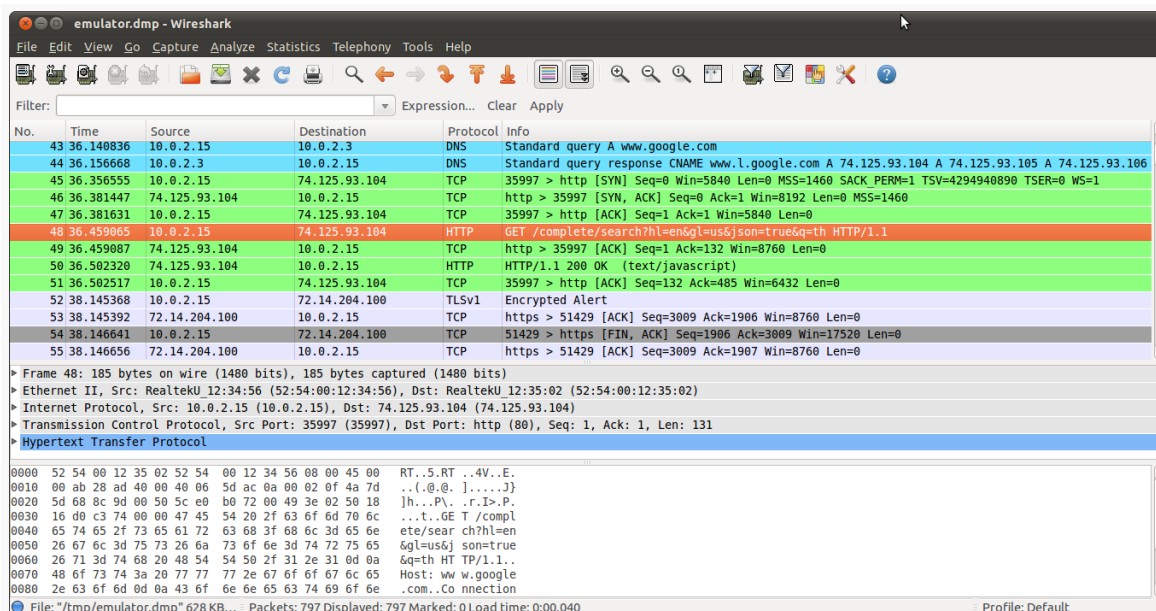


Figure 489: Wireshark examining captured emulator packets

This screenshot shows an HTTP request in the highlighted line in the list, with the hex and ASCII contents of the request shown in the bottom pane.

In terms of using Wireshark to monitor traffic from actual hardware, that is indubitably possible. However, WiFi packet collection is a tricky process with Wireshark, being very dependent upon operating system and possibly even the WiFi adapter chipset. You also get much lower-level information, making it a bit more challenging to figure out what is going on. Attempting to cover all of this is well beyond the scope of this book and the author's Wireshark expertise.

## Networking Hardware

Sophisticated firewalls sometimes have packet tracing/sniffing capability. In this case, "sophisticated" does not necessarily mean "expensive", as open source router/firewall distributions, like OpenWrt, can be used for this sort of work. In this case, the router captures the packets and, in many cases, routes them to Wireshark for analysis. Some might offer on-board analysis (e.g., Web interface to packet capture logs).

This is particularly useful on a Windows wireless network. Wireshark has limits, imposed by Windows, that cause some problems when trying to capture WiFi

packets. By offloading the packet capture to networking hardware, those limits can be bypassed.

### Tactical Measurement in DDMS

TrafficStats is great for measuring gross bandwidth consumption over some period of time. However, it requires coding, logging, and your own analysis mechanism.

Another approach is to use the new Network Statistics view available as part of DDMS. This view will report, in real time, what your receiving and transmitting bandwidth usage is, in the form of a line chart. This tool was added to the r17 edition of the Android tools.

To use this view, you will need a device running Android 4.0.3 or higher. It does not work with the emulator or older devices, unfortunately.

If you have such a device though, when you run your app on it, you can:

- Open the Network Statistics view in Eclipse (or the equivalent in the standalone monitor tool)
- Run your app and get it ready for testing
- Click on your debuggable process in the Devices view
- Choose a refresh speed for the line chart (100ms, 250ms, or 500ms) in the Network Statistics view
- Click the Start button adjacent to the speed drop-down
- Do something in your app to trigger network I/O
- Click the Stop button to freeze the updates to the line chart

What you will get, out of the box, is something like this:

## MEASURING BANDWIDTH CONSUMPTION

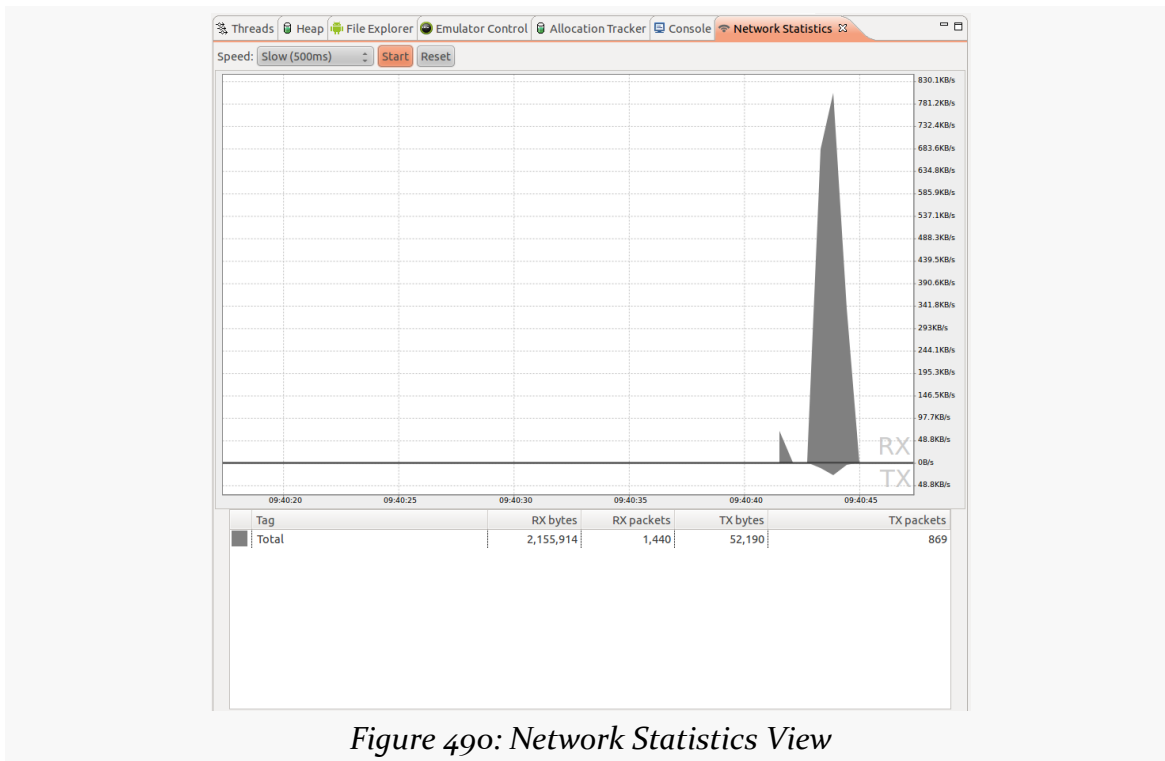


Figure 490: Network Statistics View

This particular output came from a run of the `DownloadItYourself` demo app from earlier in the book. The table at the bottom shows the total amount of bandwidth consumed during the test run, and the line chart at the top helps to illustrate when we consumed that bandwidth. Received bandwidth appears above the baseline; transmitted bandwidth appears below the baseline.

For fairly simple cases, this is all you will need. If, however, you have lots of things going on, you might want to track individual bits of network I/O. Android supports a tagging concept that will help with this, allowing you to associate a tag with the current thread.

In most cases, if you are using higher-level libraries like `URLConnection` or `HttpClient`, you would use `setThreadStatsTag()`, a static method added to `TrafficStats` in API Level 14. You supply an integer “tag”, which will be associated with network I/O performed on that tag from those libraries. If you are working with raw sockets, you will also need to use `tagSocket()` and `untagSocket()` to associate the work for that socket with the tag for the current thread.

This will then give you a much more detailed set of output, showing not only total network I/O but per-tag network I/O:

## MEASURING BANDWIDTH CONSUMPTION

---

![[Network Statistics Detailed View (image courtesy of Android Open Source Project)]](Screenshot-Dalvik Debug Monitor-1.png)

Clicking the Reset button, to the right of the Start button, clears the graph and table, to give you fresh results for your next test.





# Being Smarter About Bandwidth

---

Given that you are [collecting metrics about bandwidth consumption](#), you can now start to determine ways to reduce that consumption. You may be able to permanently reduce that consumption (at least on a per-operation basis). You may be able to shunt that consumption to times or networks that the user prefers. This chapter reviews a variety of means of accomplishing these ends.

## Prerequisites

Understanding this chapter requires that you have read the core chapters and understand how Android apps are set up and operate, particularly the [chapter on Internet access](#).

## Bandwidth Savings

The best way to reduce bandwidth consumption is to consume less bandwidth.

(in other breaking news, water is wet)

In recent years, developers have been able to be relatively profligate in their use of bandwidth, pretty much assuming everyone has an unlimited high-speed Internet connection to their desktop or notebook and the desktop or Web apps in use on them. However, those of us who lived through the early days of the Internet remember far too well the challenges that dial-up modem accounts would present to users (and perhaps ourselves). Even today, as Web apps try to “scale to the Moon and back”, bandwidth savings becomes important not so much for the end user, but for the Web app host, so its own bandwidth is not swamped as its user base grows.

Fortunately, widespread development problems tend to bring rise to a variety of solutions — a variant on the “many eyes make bugs shallow” collaborative development phenomenon. Hence, there are any number of tried-and-true techniques for reducing bandwidth consumption that have had use in Web apps and elsewhere. Many of these are valid for native Android apps as well, and a few of them are profiled in the following sections.

### Classic HTTP Solutions

Trying to get lots of data to fit on a narrow pipe — whether that pipe is on the user’s end or the provider’s end — has long been a struggle in Web development. Fortunately, there are a number of ways you can leverage HTTP intelligently to reduce your bandwidth consumption.

### GZip Encoding

By default, HTTP requests and response are uncompressed. However, you can enable GZip encoding and thereby request that the server compress its response, which is then decompressed on the client. This trades off CPU for bandwidth savings and therefore needs to be done judiciously.

Enabling GZip compression is a two-step process:

- Adding the `Accept-Encoding: gzip` header to the HTTP request
- Determine if the response was compressed and, if so, decompressing it

Bear in mind that the Web server may or may not honor your GZip request, for whatever reason (e.g., response is too small to make it worthwhile).

For example, using the `HttpClient` library in Android, you could add the header on the request:

```
HttpGet get=new HttpGet(url);
get.addHeader("Accept-Encoding", "gzip");
// rest of configuration here, if any
// execute the request given an HttpClient object named client
HttpResponse response=client.execute(get);
```

Then, you can check the response and get a valid `InputStream` for either the compressed or the not-compressed cases:

## BEING SMARTER ABOUT BANDWIDTH

---

```
// assumes HttpResponse response as in above code snippet

InputStream stream=response.getEntity().getContent();
Header enc=response.getFirstHeader("Content-Encoding");

if (enc!=null && enc.getValue().equalsIgnoreCase("gzip")) {
    stream=new GZIPInputStream(stream);
}

// at this point, stream will work for either encoding
```

Equivalents exist for using `URLConnection`, if you prefer to use that HTTP API in Android.

### If-Modified-Since / If-None-Match

Of course, avoiding a download offers near-100% compression. If you are caching data, you can take advantage of HTTP headers to try to skip downloads that are the same content as what you already have, specifically `If-Modified-Since` and `If-None-Match`.

An HTTP response can contain either a `Last-Modified` header or an `ETag` header. The former will contain a timestamp and the latter will contain some opaque value. You can store this information with the cached copy of the data (e.g., in a database table). Later on, when you want to ensure you have the latest version of that file, your HTTP GET request can include an `If-Modified-Since` header (with the cached `Last-Modified` value) or an `If-None-Match` header (with the cached `ETag` value). In either case, the server should return either a 304 response, indicating that your cached copy is up to date, or a 200 response with the updated data. As a result, you avoid the download entirely (other than HTTP headers) when you do not need the updated data.

For example, using `HttpClient`, you can check for the existence of an `ETag` header in an HTTP response:

```
HttpGet get=new HttpGet(url);

// execute the request given an HttpClient object named client
HttpResponse response=client.execute(get);
Header etag=response.getFirstHeader("ETag");

if (etag!=null) {
    // cache this
}

// process the download
```

On subsequent requests, you can add the If-None-Match header and handle both cases:

```
HttpGet get=new HttpGet(url);

get.addHeader("If-None-Match", etag);

// execute the request given an HttpClient object named client
HttpResponse response=client.execute(get);
int sc=response.getStatusLine().getStatusCode();

if (sc!=HttpStatus.SC_NOT_MODIFIED) {
    // cache invalid, so process the download and, perhaps, grab fresh
    ETag
}
```

Using Last-Modified and If-Modified-Since is mostly a matter of switching headers. And, once again, there are equivalent ways to use these headers with `URLConnection`.

### Binary Payloads

While XML and JSON are relatively easy for humans to read, that very characteristic means they tend to be bloated in terms of bandwidth consumption. There are a variety of tools, such as Google's [Protocol Buffers](#) and Apache's [Thrift](#), that allow you to create and parse binary data structures in a cross-platform fashion. These might allow you to transfer the same data that you would in XML or JSON in less space. As a side benefit, parsing the binary responses is likely to be faster than parsing XML or JSON. Both of these tools involve the creation of an IDL-type file to describe the data structure, then offer code generators to create Java classes (or equivalents for other languages) that can read and write such structures, converting them into platform-neutral on-the-wire byte arrays as needed.

### Minification

If you are loading JavaScript or CSS into a `WebView`, you should consider standard tricks for compressing those scripts, collectively referred to as "[minification](#)". These techniques eliminate all unnecessary whitespace and such from the files, rename variables to be short, and otherwise create a syntactically-identical script that takes up a fraction of the space. There are services like [box.js](#) that can even aggregate several scripts into one file and minify them, to further reduce HTTP overhead.

### Push versus Poll

Another way to consume less bandwidth is to only make the requests when it is needed. For example, if you are writing an email client, the way to use the least bandwidth is to download new messages only when they exist, rather than frequently polling for messages.

Off the cuff, this may seem counter-intuitive. After all, how can we know whether or not there are any messages if we are not polling for them?

The answer is to use a low-bandwidth push mechanism. The quintessential example of this is GCM, the Google Cloud Messaging system, available for Android 2.2 and newer. This service from Google allows your application to subscribe to push notifications sent out by your server. Those notifications are delivered asynchronously to the device by way of Google's own servers, using a long-lived socket connection. All you do is register a `BroadcastReceiver` to receive the notifications and do something with them.

For example, Remember the Milk — a task management Web site and set of mobile apps — uses GCM to alert the device of task changes you make through the Web site. Rather than the Remember the Milk app having to constantly poll to see if tasks were added, changed, or deleted, the app simply waits for GCM events.

You could create your own push mechanism, perhaps using a `WebSocket` or Comet-style long-poll technique. The downside is that you will need a service in memory all of the time to manage the socket and thread that monitors it. If you only need this while your service is in memory for other reasons, that is fine. However, keeping a service in memory 24x7 has its own set of issues, not the least of which is that users will tend to smack it down using a “task killer” or the Manage Services screen in the Settings app.

### Thumbnails and Tiles

A general rule of thumb is: don't download it until you really need it.

Sometimes, you do not know if you really need a particular item until something happens in the UI. Take a `ListView` displaying thumbnails of album covers for a music app. Assuming the album covers are not stored locally, you will need to download them for display. However, which covers you need varies based upon scrolling. Downloading a high-resolution album cover that might get tossed in a

matter of milliseconds (after an expensive rescale to fit a thumbnail-sized space) is a waste of bandwidth.

In this case, either the album covers are something you control on the server side, or they are not. If they are, you can have the server prepare thumbnails of the covers, stored at a spot that the app can know about (e.g., `.../cover.jpg` it is `.../thumbnail.jpg`). The app can then download thumbnails on the fly and only grab the full-resolution cover if needed (e.g., user clicks on the album to bring up a detail screen). If you do not control the album covers, this option might still be available to you if you can run your own server for the purposes of generating such thumbnails.

You can see a similar effect with the map tiles in Google Maps. When zooming out, the existing map tiles are scaled down, with placeholders (the gridlines) for the remaining spots, until the tiles for those spots are downloaded. When zooming in, the existing map tiles are scaled up with a slight blurring effect, to give the user some immediate feedback while the full set of more-detailed tiles is downloaded. And, if the user pans, you once again get placeholders while the tiles for the newly uncovered areas are downloaded. In this fashion, Google Maps is able to minimize bandwidth consumption by giving users partial results immediately and back-filling in the final results only when needed. This same sort of approach may be useful with your own imagery.

### Collaborative Bandwidth

For some common services, perhaps sharing is the best option to reduce bandwidth usage.

For example, consider Twitter. It is entirely possible that a user might have multiple applications all polling and downloading the user's timeline:

1. A built-in Twitter app that the user does not like, but cannot uninstall
2. A regular Twitter app that the user employs for normal stuff
3. A separate Twitter app widget, because the other Twitter apps on the device either lack an app widget or the user does not like it
4. Yet another application that uses Twitter as one of several data sources (e.g., monitoring for references to certain keywords, such as a company name, across multiple social networks)

In an ideal world, all of these apps would use one common engine that handles collecting the tweets and making them available — securely — to the other

applications. This would dramatically cut bandwidth by eliminating redundant polling.

If your data source is used by other applications, consider reaching out to those developers and creating a common engine, perhaps using a `ContentProvider` for data sharing, an `IntentService` or sync provider for collecting the data, plus common activities for preferences. Distribute the code to all of the development teams as an Android library project. Ship these components disabled in your manifest, enabling them if you cannot find another implementation on the device, indicating that you are the only one of this “application family” installed. If you do find another implementation, use that one instead of your own. There are certainly issues to be dealt with here (e.g., what if the user uninstalls the app that the others are depending upon), but it is worth considering for shared development costs as well as shared bandwidth.

## Bandwidth Shaping

Sometimes, you have no ability to reduce the bandwidth itself. Perhaps you do not control both ends of the communications pipeline. Perhaps the data you are trying to exchange is already compressed (e.g., downloading an MP4 video). Perhaps some of the techniques in the preceding section were unavailable to you (e.g., cannot route data through third-party servers like Google’s for C2DM).

There still may be ways for you to help your users, by shaping your bandwidth use. Rather than just blindly doing whatever you want whenever you want, you learn what the *user* wants and what *other applications* want and tailor your bandwidth use on the fly to match those needs. The following sections outline some ways of achieving this.

### Driven by Preferences

If you are consuming enough bandwidth that this chapter is relevant to you, you probably are consuming enough bandwidth that you should be asking the user how best to consume that bandwidth. After all, they are the one paying the price — in time as well as money – for that consumption.

The following sections present some possible strategies for preference-based bandwidth shaping.



### Budgets

One strategy is for the user to give you a budget (e.g., 20MB/day) and for you to stick within that budget.

Collecting the budget is fairly easy — just use `SharedPreferences`. Either use a `ListPreference` with likely budget value or an `EditTextPreference` and a bit of validation for a free-form budget amount.

Next, you will need to have some idea how much bandwidth any given network operation will consume. For some things, this might be an estimate based on your experiments as a developer, or perhaps it is based on historical averages for this user and type of operation. For example, a “podcatcher” (feed reader designed to download podcast episodes) should have some idea how big a given RSS or Atom feed download should be. In some cases, it might be worthwhile to get a better estimate — for example, the podcatcher might use an HTTP HEAD request to determine the size of the MP3 or OGG file before deciding whether to download it.

Then, you need to be keeping track of your budget. This could be a simple flat file with the initial `TrafficStats` bandwidth values for your process. Re-initialize that file on the first network operation of the day (or whatever period you chose for your budget). Before doing another network operation, compare the current `TrafficStats` values with the initial ones and see how close you are to the budget. If the new network operation will exceed the budget, skip the operation, perhaps putting it in a work queue to perform in the next budget. You might even hold a reserve for certain types of operations. For example, the podcatcher might ensure there is at least 10% of the budget available for downloading the feeds, even if it means putting a podcast on the queue for download tomorrow. That way, you can present to the user the latest podcast information, with icons indicating which are downloaded and which are queued for download — the user might be able to then request to override the budget and download something on demand.

For devices that lack per-UID `TrafficStats` support, you will have to “fake it” a bit. Use your own calculations of how much bandwidth each operation consumes and track that information, even if you wind up missing out on some bytes here or there.

### Connectivity

If the user might not care how much bandwidth you consume, so long as it is unmetered bandwidth, you might include a `CheckBoxPreference` to indicate if large network operations should be limited to WiFi and avoid mobile data.

You could then use `ConnectivityManager` and `getActiveNetworkInfo()` to see what connection you have before performing a network operation. If it is a background operation (e.g., the podcatcher checking for new podcasts every hour), if the network is not the desired one, you can skip the operation or put it on a work queue for re-trying later. If it is a foreground operation (e.g., the user clicked a “refresh” menu choice), you could pop up a confirmation `AlertDialog` to warn the user that they are on mobile data — perhaps this time they are interested in doing the operation anyway.

Another approach for handling the background operations is to register a `BroadcastReceiver` for the `CONNECTIVITY_ACTION` broadcast (defined on `ConnectivityManager`). If the connectivity switches to mobile data, cancel your outstanding `AlarmManager` alarms; if connectivity switches to WiFi, re-enable those alarms.

Of course, you should also consider monitoring the background data setting — the global Settings checkbox indicating whether background network operations are allowed. On `ConnectivityManager`, `getBackgroundDataSetting()` tells you the state of this checkbox, and `ACTION_BACKGROUND_DATA_SETTING_CHANGED` allows you to set up a `BroadcastReceiver` to watch for changes in its state.

### Windows

If your user is less concerned about the bandwidth or the network, but does care about the time of day (e.g., does not want your application consuming significant bandwidth when they might be getting a VOIP call), you could offer preferences for that as well. Cook up a `TimePreference` and use that to collect start and stop times for the high-bandwidth window. Then, set up alarms with `AlarmManager` for those points in time. The alarm for the start time of the window sets up a third alarm with your regular polling interval. The alarm for the stop time of the window cancels the polling interval alarm.

### Driven by Other Usage

If your network I/O is part of a foreground application, one presumes that you are the most important thing in the user's life right now. Or, at least, the most important thing on the user's phone right now. Hence, what other applications might want to do with the Internet connection is not a major concern.

If, however, your network I/O is part of a background operation, it might be nice to try to avoid doing things that might upset the user. If the user is watching streaming video or is on a VOIP call or otherwise is aware of bandwidth changes, the bandwidth you use might impact the user in ways that the user will not appreciate very much. This is unlikely to be a big problem for small operations (e.g., downloading a 1KB JSON file), but larger operations (e.g., downloading a 5MB podcast) might be more noticeable.

You can use `TrafficStats` to help here. Before doing the actual network I/O, grab the current traffic data, wait a couple of seconds, and compare the latest to the previous values. If little to no bandwidth was consumed during that period, assume it is safe and go ahead and do your work. If, however, a bunch of bandwidth was consumed, you might want to consider:

1. Skipping this polling cycle and trying again later, or
2. Adding a one-off alarm using `set()` on `AlarmManager` to give you control again in a minute, with the current traffic data packaged as an extra on the `Intent`, so you can make a decision after a bigger sample size of bandwidth consumption, or
3. Adding an entry in a persistent work queue, so you know later on to try again if bandwidth contention has improved

You could try to get more sophisticated, by using `ActivityManager` and the per-UID values from `TrafficStats` to see if it is a foreground application that is the one consuming the bandwidth. It is unclear how reliable this will be, both in determining who is consuming the bandwidth (again, per-UID traffic is not available on many devices) and in avoid user angst. It may be simpler just to assume the worst and side-step your I/O until the other apps have quieted down.

### Avoiding Metered Connections

Android 4.1 (a.k.a., Jelly Bean) added `isActiveNetworkMetered()` as a method on `ConnectivityManager`. In principle, this will return `true` if Android thinks that the

## BEING SMARTER ABOUT BANDWIDTH

---

current data connection may involve bandwidth charges. You can examine this value and steer your bandwidth consumption accordingly.



# Issues with Memory

---

RAM. Developers nowadays are used to having lots of it, and a virtual machine capable of using as much of it as exists (and more, given swap files and page files).

“Graybeards” — like the author of this book — distinctly remember a time when we had 16KB of RAM and were happy for it. Such graybeards would also appreciate it if you would get off their respective lawns.

Android comes somewhere in the middle. We have orders of magnitude more RAM than, say, the TRS-80 Model III. We do not have nearly as much RAM as does the modern notebook, let alone a Web server. As such, it is easy to run out of RAM if you do not take sufficient care.

This part of the book examines memory-related issues. These are not to be confused with any memory-related issues inherent to graybeards.

## Prerequisites

Understanding this chapter requires that you have read the core chapters and understand how Android apps are set up and operate, particularly the [chapter on Android’s process model](#).

## You Are in a Heap of Trouble

When we think of “memory” and Java-style programming, the primary form of memory is the heap. The heap holds all of our Java objects – from an Activity to a widget to a String.

Traditional Java applications have an initial heap size determined by the virtual machine, possibly configured via command-line options when the program was run. Traditional Java applications can also request additional memory from the OS, up to some maximum, also configurable.

Android applications have the same basic structure, with very limited configurability and much lower maximums than you might expect.

Older Android devices, particularly those with HVGA screens like the T-Mobile G1, tend to have a maximum of 16MB of heap space. Newer Android phones with higher-resolution screens might have 24MB (Motorola DROID) or 32MB (Nexus One) of heap space. Tablets might have 48MB of heap space.

This heap limit can be problematic. For example, each widget or layout manager instance takes around 1KB of heap space. This is why `AdapterView` provides the hooks for view recycling — we cannot have a `ListView` with literally thousands of row views without potentially running out of heap.

API Level 11+ supports applications requesting a “large heap”. This is for applications that specifically need tons of RAM, such as an image editor to be used on a tablet. This is not for applications that run out of heap due to leaks or sloppy programming. Bear in mind that users will feel effects from large-heap applications, in that their other applications will be kicked out of memory more quickly, possibly irritating them. Also, garbage collection on large-heap applications runs more slowly, consuming more CPU time. To enable the large heap, add `android:largeHeap="true"` to the `<application>` element of your manifest. You can call `getLargeMemoryClass()` on `ActivityManager` to learn how large your “large heap” actually is.

## Warning: Contains Graphic Images

However, the most likely culprit for `OutOfMemoryError` messages are bitmaps. Bitmaps take up a remarkable amount of heap space. Developers often look at the size of a JPEG file and think that “oh, well, that’s only a handful of KB”, without taking into account:

1. the fact that most image formats, like JPEG and PNG, are compressed, and Android needs the uncompressed image to know what to draw
2. the fact that each pixel may take up several bytes (2 bytes per pixel for `RGB_565`, 3 bytes per pixel for `RGB_888`)

3. what matters is the resolution of the bitmap in its original form, as much (if not more) than the size in which it will be rendered – an 800x480 image displayed in an 80x48 Imageview still consumes 800x480 worth of pixel data
4. there are an awful lot of pixels in an image — 800 times 480 is 384,000

Android can make some optimizations, such as only loading in one copy of a Drawable resource no matter how many times you render it. However, in general, each bitmap you load takes a decent sized chunk of your heap, and too many bitmaps means not enough heap. It is not unheard of for an application to have more than half of its heap space tied up in various bitmap images.

Compounding this problem is that bitmap memory, before Honeycomb, was difficult to measure. In the actual Dalvik heap, a Bitmap would need ~80 bytes or so, regardless of image size. The actual pixel data was held in “native heap”, the space that a C/C++ program would obtain via calls to `malloc()`. While this space was still subtracted from the available heap space, many diagnostic programs — such as MAT, to be examined in the next chapter — will not know about it. Android 3.0 (code-named “Honeycomb”) moved the pixel data into the Dalvik heap, which will improve our ability to find and deal with memory leaks or overuse of bitmaps.

This part of the book will cover techniques to identify where you might be leaking memory and what is consuming all of your heap space if you are running out of it. We will also examine ways to avoid such leaks and be more efficient in your memory consumption, particularly with bitmaps.

## In Too Deep (on the Stack)

Heap, however, is not the only possible source of memory errors. It is also possible to get an `StackOverflowError`, indicating that you have run out of stack space (or possibly that the [leading Android developer support resource](#) is down for maintenance).

In stack-based programming languages like Java, each time you call a method, some stack space is consumed. While method parameters are objects that live on the heap, the parameter references are stored on the stack, as is information about the method being invoked. References to local data members to the method or blocks inside of it are also stored on the stack.

Since these references only take up ~4 bytes each, you would think it might take a minor eternity to run out of stack space. However, the main application thread in



your Android application has an 8KB stack, which means you can run out of stack space with only a couple of thousand objects on it.

Even still, it would take hundreds and hundreds of nested method invocations to put a couple of thousand objects onto the stack. In normal programming, you might only encounter this with a runaway bit of recursion, in which case no amount of stack would save you.

However, Android GUIs are fairly stack-driven. You can run out of stack space if your UI becomes too complex. More specifically, you might run out of stack space if your view hierarchy — from the root container of the Android window to the widgets inside of the containers inside of your rows inside of your `ListView` inside of your `TabHost` — gets too deep. A depth of 15 or so makes you very likely to run out of stack space somewhere along the line. So if you get the stack-space exception and the stack trace seems to be all in Android UI rendering code, your view hierarchy is probably too complex. In this part of the book, we will examine how to measure your view hierarchy depth and ways of trying to simplify it.

# Finding Memory Leaks with MAT

---

The Eclipse Memory Analyzer (MAT) is your #1 tool for identifying memory leaks and the culprits behind running out of heap space. Particularly when used with Honeycomb or newer versions of Android, MAT can identify:

1. Who are the major sources of memory consumption, both directly (e.g., bitmaps) or indirectly (e.g., leaked activities holding onto lots of widgets)
2. What is keeping objects in memory unexpectedly, defying standard garbage collection — the way that you leak memory in a managed runtime environment like Dalvik

This chapter will identify how to collect heap data for use with MAT and how to use MAT to make sense of what the heap is trying to tell us about what is going on inside of your app.

## Prerequisites

Understanding this chapter requires that you have read the core chapters and understand how Android apps are set up and operate, particularly the [chapter on Android's process model](#). Reading [the introductory chapter to this trail](#) might be nice.

## Setting Up MAT

MAT is an official Eclipse project, [hosted on the Eclipse Web site](#). It comes in two flavors:

## FINDING MEMORY LEAKS WITH MAT

---

1. A plug-in for Eclipse itself, providing a new “Memory Analysis” perspective and related tools
2. A standalone version, running in the Eclipse RCP framework

Some developers may prefer the standalone version, because they run into problems when their Eclipse workspaces have too many plugins. Some developers may prefer the integrated version, because two Eclipse-based apps would consume too much RAM. With MAT, you have your choice.

There is a traditional [download link](#) to get the standalone edition. As with other Eclipse plug-ins, you will need to add the MAT update site to Eclipse — for example, in Eclipse Galileo:

1. Choose Help|Install New Software... from the main menu
2. Click the Add... button in the upper-right corner of the dialog, fill in `http://download.eclipse.org/mat/1.1/update-site/` as the Location and whatever name you want, then click OK
3. Choose Memory Analyzer for Eclipse IDE and complete the rest of the new-software wizard

## Getting Heap Dumps

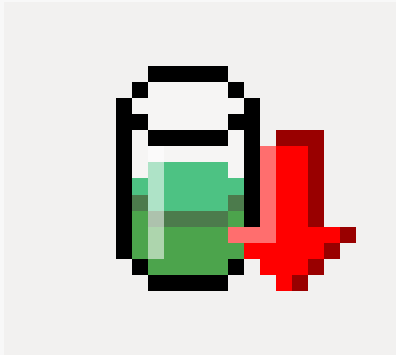
The first step to analyzing what is in your heap is to actually get your hands on what is in your heap. This is referred to as creating a “heap dump” — what amounts to a log file containing all your objects and who points to what.

There are multiple ways of obtaining a heap dump, depending on your tools and use cases. Note that you will find some blog post and the like indicating you can create a heap dump via the `adb shell kill` command, but this has been disabled in newer versions of Android.

### From DDMS

You can get a heap dump any time you want from DDMS, using either the DDMS perspective or the standalone DDMS utility.

In the device-and-process tree (the Devices tool in Eclipse), you will find a toolbar button that looks like a half-empty can with a downward-pointing arrow:



*Figure 491: The icon used for the “Dump HPROF File” toolbar button*

Clicking this — after choosing your desired process — DDMS will create a heap dump for you. However, the process varies at this point, depending on whether you are using the DDMS perspective in Eclipse or standalone DDMS.

### **DDMS Perspective**

Once you click the toolbar button for the heap dump, DDMS will create the dump for you, in a file generated in your development machine’s temporary-files directory (e.g., /tmp). If you wish to save this dump for some reason, you will want to rename it and move it to some other location.

### **Standalone DDMS**

Once you click the toolbar button for the heap dump, DDMS will create the dump for you, in a file chosen by you via your platform’s standard file-save dialog.

Then, however, you will need to run the `hprof-conv` utility, from the `tools/` directory of your SDK, to convert the heap dump into the format that MAT will use. This is automatic if you use the DDMS perspective in Eclipse.

### **From Code**

Another possibility is to trigger the heap dump yourself from code. The `dumpHprofData()` static method on the `Debug` class (in the `android.os` package) will write out a heap dump to the file you indicate. Since these files can be big, and since you will need to transfer them off the device or emulator, it will be best to specify a path to a file on external storage, which means that your project will need the `WRITE_EXTERNAL_STORAGE` permission.

## FINDING MEMORY LEAKS WITH MAT

---

To view the results in MAT, you will need to transfer the file to your development machine (e.g., DDMS File Manager, `adb pull`, using MTP-mounted external storage on Android 3.0+).

### Automating Heap Dumps in Testing

One problem with using `dumpHprofData()` is that there is no logical reason to have that code in your production app. Fortunately, you can use it from a JUnit test suite that uses the Android instrumentation framework. However, the main project, not the test project, is the one that needs `WRITE_EXTERNAL_STORAGE` — with luck, your app needs this permission anyway.

The problem then becomes a matter of figuring out where in the JUnit test suite to call `dumpHprofData()`. One strategy is simply to add it to specific test methods or test cases, if you want to have a dump at specific points. If, however, you want a dump at the end of the complete battery of tests, you will need to create your own test runner.

For example, in the [MAT/Spinners](#) sample project, you will find a near-identical clone of the same project from elsewhere in this book. It simply runs through a pathetic little test suite for an app that displays contact data in a `ListView`, driven by a `Spinner` to select what data you want to see.

The augmented version of this project adds an `HprofTestRunner` that will dump the heap at the end of the run:

```
package com.commonware.android.contacts.spinners;

import java.io.File;
import java.io.IOException;
import android.os.Bundle;
import android.os.Debug;
import android.os.Environment;
import android.test.InstrumentationTestRunner;

public class HprofTestRunner extends InstrumentationTestRunner {
    @Override
    public void finish(int resultCode, Bundle results) {
        try {
            Debug.dumpHprofData(new File(Environment.getExternalStorageDirectory(),
                "hprof.dmp").getAbsolutePath());
        }
        catch (IOException e) {
            e.printStackTrace();
        }
    }
}
```

## FINDING MEMORY LEAKS WITH MAT

---

```
    super.finish(resultCode, results);
  }
}
```

To add code at the end of a test run, simply override the `finish()` method, do your work, then chain to the superclass. Here, we create an `hprof.dmp` file out in the root of external storage. Note that the runner does not log to LogCat, which is why this code uses the classic `printStackTrace()` to dump any exceptions to the test runner's own error log.

To use the `HprofTestRunner`, you need to update the `android:name` attribute in the `<instrumentation>` element in your manifest to reference this runner class:

```
<?xml version="1.0" encoding="utf-8"?>
<!-- package name must be unique so suffix with "tests" so package loader
doesn't ignore us -->
<manifest xmlns:android="http://schemas.android.com/apk/res/android"
    package="com.commonware.android.contacts.spinners.tests"
    android:versionCode="1"
    android:versionName="1.0">
    <!-- We add an application tag here just so that we can indicate that
    this package needs to link against the android.test library,
    which is needed when building test cases. -->
    <application>
        <uses-library android:name="android.test.runner" />
    </application>
    <!--
    This declares that this application uses the instrumentation test runner
    targeting
    the package of com.commonware.android.contacts.spinners. To run the tests
    use the command:
    "adb shell am instrument -w com.commonware.android.contacts.spinners.tests/
    android.test.InstrumentationTestRunner"
    -->
    <instrumentation
    android:name="com.commonware.android.contacts.spinners.HprofTestRunner"

    android:targetPackage="com.commonware.android.contacts.spinners"
        android:label="Tests for
    com.commonware.android.contacts.spinners"/>
</manifest>
```

Also, in your `build.xml` file for Ant, you will need to add the `test.runner` property, identifying the same class, before the `<setup/>` tag:

```
<?xml version="1.0" encoding="UTF-8"?>
<project name="SpinnersTests" default="help">

    <!-- The local.properties file is created and updated by the 'android' tool.
    It contains the path to the SDK. It should *NOT* be checked into
```

## FINDING MEMORY LEAKS WITH MAT

---

```
Version Control Systems. -->
<property file="local.properties" />

<!-- The ant.properties file can be created by you. It is only edited by the
'android' tool to add properties to it.
This is the place to change some Ant specific build properties.
Here are some properties you may want to change/update:

source.dir
    The name of the source directory. Default is 'src'.
out.dir
    The name of the output directory. Default is 'bin'.

For other overridable properties, look at the beginning of the rules
files in the SDK, at tools/ant/build.xml

Properties related to the SDK location or the project target should
be updated using the 'android' tool with the 'update' action.

This file is an integral part of the build system for your
application and should be checked into Version Control Systems.

-->
<property file="ant.properties" />

<!-- if sdk.dir was not set from one of the property file, then
get it from the ANDROID_HOME env var.
This must be done before we load project.properties since
the proguard config can use sdk.dir -->
<property environment="env" />
<condition property="sdk.dir" value="${env.ANDROID_HOME}">
    <isset property="env.ANDROID_HOME" />
</condition>

<!-- The project.properties file is created and updated by the 'android'
tool, as well as ADT.

This contains project specific properties such as project target, and
dependencies. Lower level build properties are stored in ant.properties
(or in .classpath for Eclipse projects).

This file is an integral part of the build system for your
application and should be checked into Version Control Systems. -->
library <loadproperties srcFile="project.properties" />

<!-- quick check on sdk.dir -->
<fail
    message="sdk.dir is missing. Make sure to generate local.properties
using 'android update project' or to inject it through the ANDROID_HOME
environment variable."
    unless="sdk.dir"
/>
```

## FINDING MEMORY LEAKS WITH MAT

---

```
<!--
  Import per project custom build rules if present at the root of the
  project.
  This is the place to put custom intermediary targets such as:
    -pre-build
    -pre-compile
    -post-compile (This is typically used for code obfuscation.
                   Compiled code location: ${out.classes.absolute.dir}
                   If this is not done in place, override
${out.dex.input.absolute.dir})
    -post-package
    -post-build
    -pre-clean
-->
<import file="custom_rules.xml" optional="true" />

<!-- Import the actual build file.

  To customize existing targets, there are two options:
  - Customize only one target:
    - copy/paste the target into this file, *before* the
      <import> task.
    - customize it to your needs.
  - Customize the whole content of build.xml
    - copy/paste the content of the rules files (minus the top node)
      into this file, replacing the <import> task.
    - customize to your needs.

  *****
  ***** IMPORTANT *****
  *****
  In all cases you must update the value of version-tag below to read
  'custom' instead of an integer,
  in order to avoid having your file be overridden by tools such as
  "android update project"
-->
<!-- version-tag: custom -->
<property name="test.runner"
value="com.commonware.android.contacts.spinners.HprofTestRunner" />
<import file="${sdk.dir}/tools/ant/build.xml" />

</project>
```

Then, running the tests via `ant debug install test` will use your runner and will dump the HPROF file at the end of the run. You could also elect to automate retrieving the HPROF file by adding an Ant task that will use `adb pull` to retrieve the file from where it is stored.

If you wish to run your tests through Eclipse, you will need to change the Instrumentation property of your test projects to point to your custom InstrumentationTestRunner subclass.



### Basic MAT Operation

Once you have MAT installed and you have obtained a heap dump, you can start doing some analysis.

### Loading Your Dump

If you used the DDMS perspective in Eclipse to create the heap dump, it should automatically pop you into MAT:

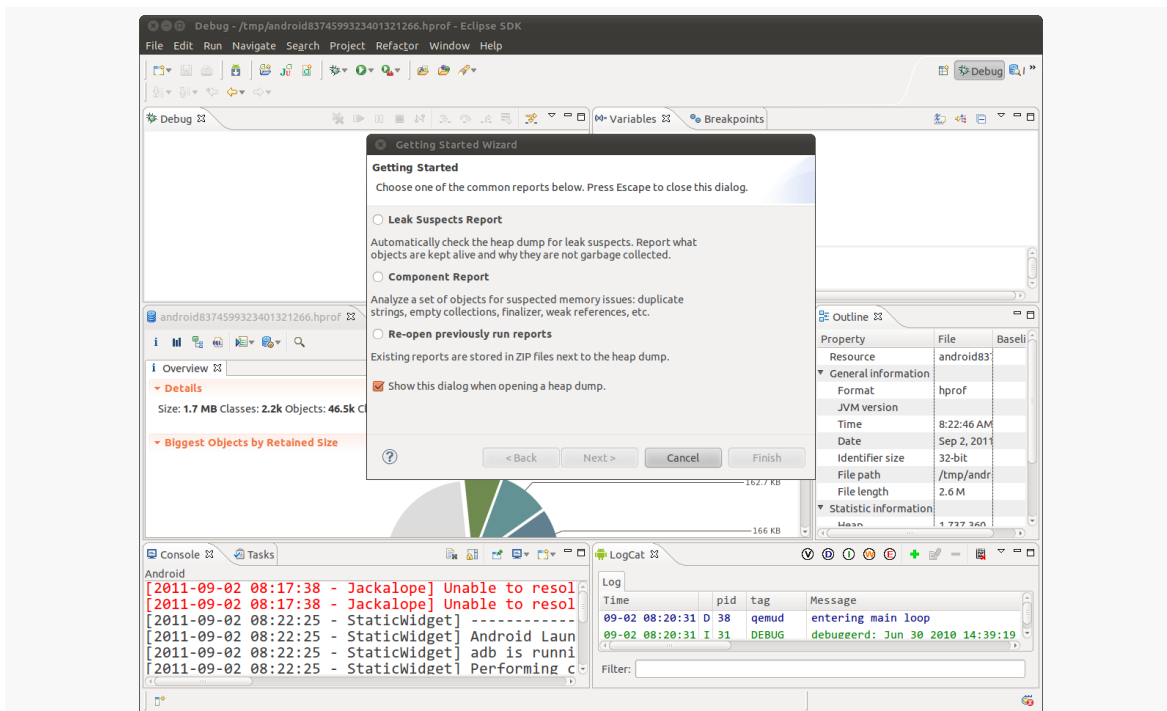


Figure 492: The MAT Eclipse perspective, as initially opened

If you used standalone DDMS or the code-based way of getting a heap dump, after using `hprof-conv` to create a MAT-compatible version of your dump, you can open it using the `File|Open Heap Dump...` menu from the Eclipse (or standalone MAT) main menu.

The first time you run MAT, you will be presented with the “Getting Started Wizard” (see above screenshot), which you can use or dismiss as you see fit.

The Overview tool gives you, well, an overview of the contents of the heap dump:

## FINDING MEMORY LEAKS WITH MAT

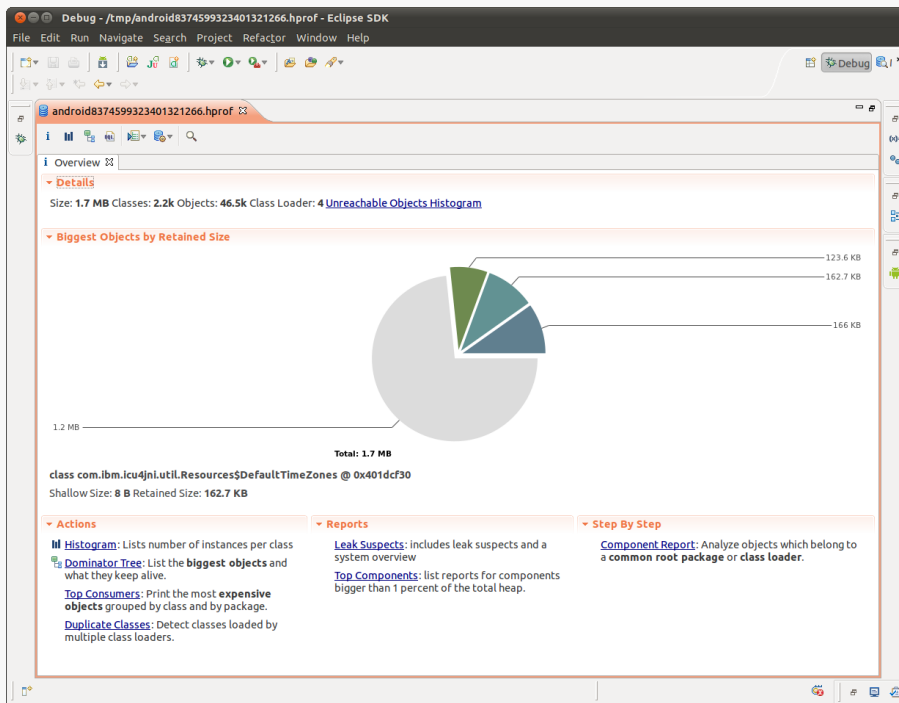


Figure 493: The Overview tool inside the MAT Eclipse perspective

The Overview tool also has links and toolbar buttons to get you to the other major functional areas within MAT.

### Finding Your Objects

If you want to see if instances of your own classes are being kept in memory despite garbage collection, you can search for objects based upon a regular expression on the fully-qualified class name.

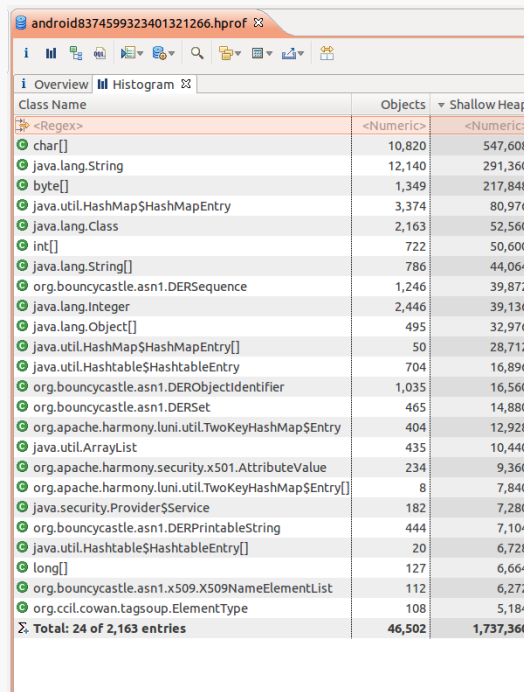
One way to access this is via the Histogram, reachable via a link in the Overview's Actions area or via a toolbar button:

## FINDING MEMORY LEAKS WITH MAT



Figure 494: The icon used for the Histogram toolbar button

The histogram initially displays the top culprits in terms of “shallow heap” — the amount of memory those objects hold onto directly:



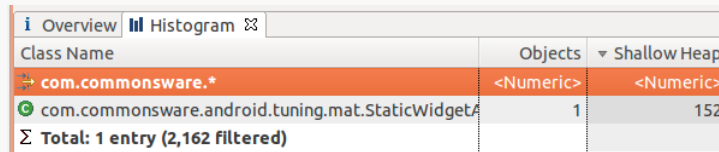
Class Name	Objects	Shallow Heap
<Regex>	<Numeric>	<Numeric>
char[]	10,820	547,608
java.lang.String	12,140	291,360
byte[]	1,349	217,848
java.util.HashMap\$HashMapEntry	3,374	80,976
java.lang.Class	2,163	52,560
int[]	722	50,600
java.lang.String[]	786	44,064
org.bouncycastle.asn1.DERSequence	1,246	39,872
java.lang.Integer	2,446	39,136
java.lang.Object[]	495	32,976
java.util.HashMap\$HashMapEntry[]	50	28,712
java.util.Hashtable\$HashtableEntry	704	16,896
org.bouncycastle.asn1.DERObjectIdentifier	1,035	16,560
org.bouncycastle.asn1.DERSet	465	14,880
org.apache.harmony.luni.util.TwoKeyHashMap\$Entry	404	12,928
java.util.ArrayList	435	10,440
org.apache.harmony.security.x501.AttributeValue	234	9,360
org.apache.harmony.luni.util.TwoKeyHashMap\$Entry[]	8	7,840
java.security.Provider\$Service	182	7,280
org.bouncycastle.asn1.DERPrintableString	444	7,104
java.util.Hashtable\$HashtableEntry[]	20	6,728
long[]	127	6,664
org.bouncycastle.asn1.x509.X509NameElementList	112	6,272
org.ccil.cowan.tagsoup.ElementType	108	5,184
<b>Total: 24 of 2,163 entries</b>	<b>46,502</b>	<b>1,737,360</b>

Figure 495: The Histogram tab inside the MAT Eclipse perspective

To see what objects of yours might still be in the heap, you can type in a regular expression (e.g., `com.commonsware.*`) in the Regex row at the top of the table, then press [Enter] to view a filtered list of objects based upon that regular expression:

## FINDING MEMORY LEAKS WITH MAT

---



Class Name	Objects	Shallow Heap
com.commonsware.*	<Numeric>	<Numeric>
com.commonsware.android.tuning.mat.StaticWidgetA	1	152
Σ Total: 1 entry (2,162 filtered)		

Figure 496: A filtered histogram, showing `com.commonsware.*` objects

Here, we see one instance of a `com.commonsware` class is still lurking around a heap dump.

### Getting Back to Your Roots

However, just because we see an object in MAT does not necessarily mean that it has been leaked. For example, this is an activity – just looking at the above screenshot does not indicate whether that activity was in the foreground, was in the background for normal reasons, or is actually leaked.

To help determine what is keeping the object in memory, you will need to trace back to the “GC roots” — the objects that are preventing our activity from being garbage collected.

To do this, you will right-click over the object in question and choose the “GC Roots” context menu choice (in the Histogram, it is “Merge Shortest Paths to GC Roots”). This will usually bring up a flyout sub-menu where you can further constrain what is reported as a root:

## FINDING MEMORY LEAKS WITH MAT

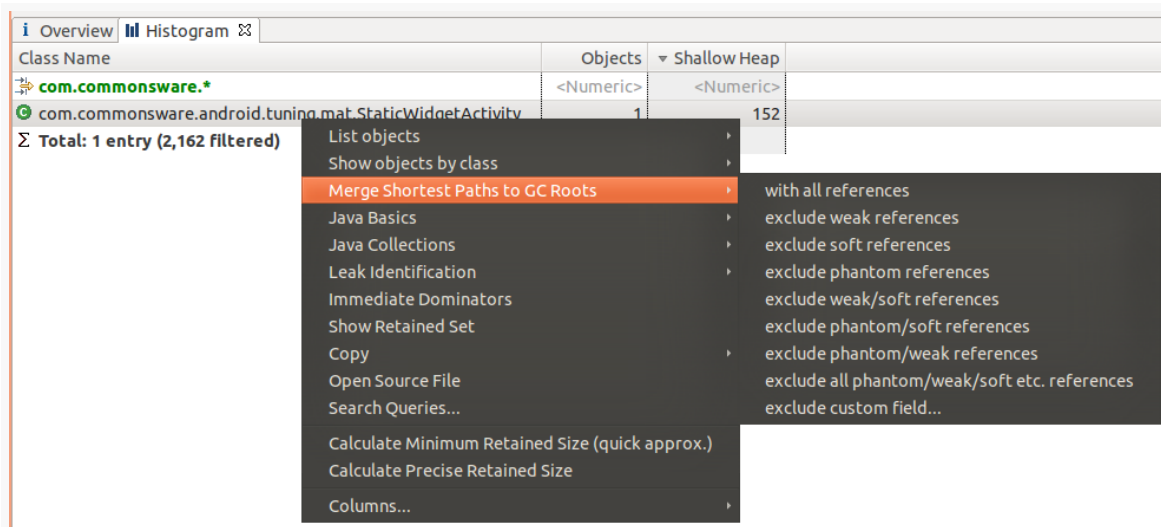


Figure 497: A filtered histogram, showing `com.commonware.*` objects

The big filters are for “soft references” and “weak references”. These refer to the `SoftReference` and `WeakReference` classes in Java, respectively. Both are ways to hold onto an object yet still allow it to be garbage collected when needed. The big difference is that an object only referenced by `WeakReference` objects can be garbage collected immediately, while an object referenced only by `SoftReference` objects (or a mix of `SoftReference` and `WeakReference` objects) should be kept around until the Dalvik VM is low on memory. Usually, you can ignore weak references, as those just indicate objects that the garbage collector has not quite detected are eligible for reclamation. Whether you want to also filter out soft references would depend a bit on the objects in question — for example, if you are using `SoftReference` with a cache, you might filter out soft references as well to confirm that nothing *other than* your cache is holding onto these objects.

Filtering out weak references (or whatever) brings up another tab containing the GC roots preventing our activity from being garbage collected:

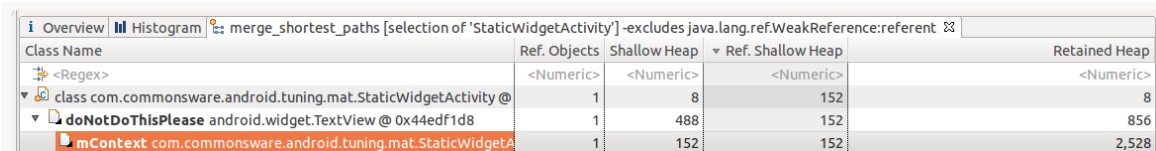


Figure 498: The GC roots holding onto an activity

## FINDING MEMORY LEAKS WITH MAT

---

This is showing that the *class* for our activity has a data member (`doNotDoThisPlease`) that has a *View*, and that in turn is holding onto our activity via an *mContext* data member. Static data members (i.e., data members of class objects) are classic sources of memory leaks in Java. The Retained Heap column on the far right shows how much memory that individual object (and everything it points to) is keeping around — in this case, about 2.5KB.

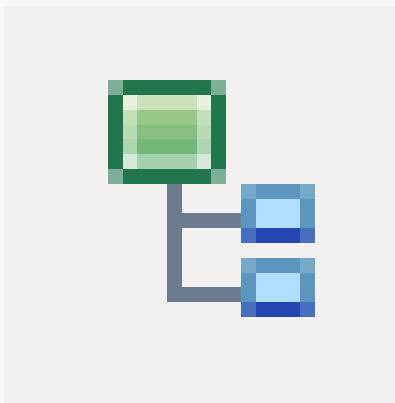
### Identifying What Else is Floating Around

This helps us find where your own objects are being leaked. What happens if you are leaking other things, though?

One possibility is to examine the rest of the Histogram tab, as it will point out the classes (and primitives) that have the most outstanding instances or hold the most aggregate shallow heap. If you applied a regular expression, you can click on the regular expression and delete it to return to the non-filtered roster. The Histogram tends to report a lot of primitives (e.g., `char[]`), and it will take some experience to learn what is standard Android application “noise” and what might represent problems.

Another way to find leaks is to examine the “dominator tree”. The term “dominator tree” comes from graph theory — object A “dominates” object B if the only paths to get to B go through A. In MAT, the dominator tree will bubble up those objects whose retained heap — the total memory the object is responsible for, including objects it links to — are high. Or, as MAT describes it, it lists “the biggest objects”.

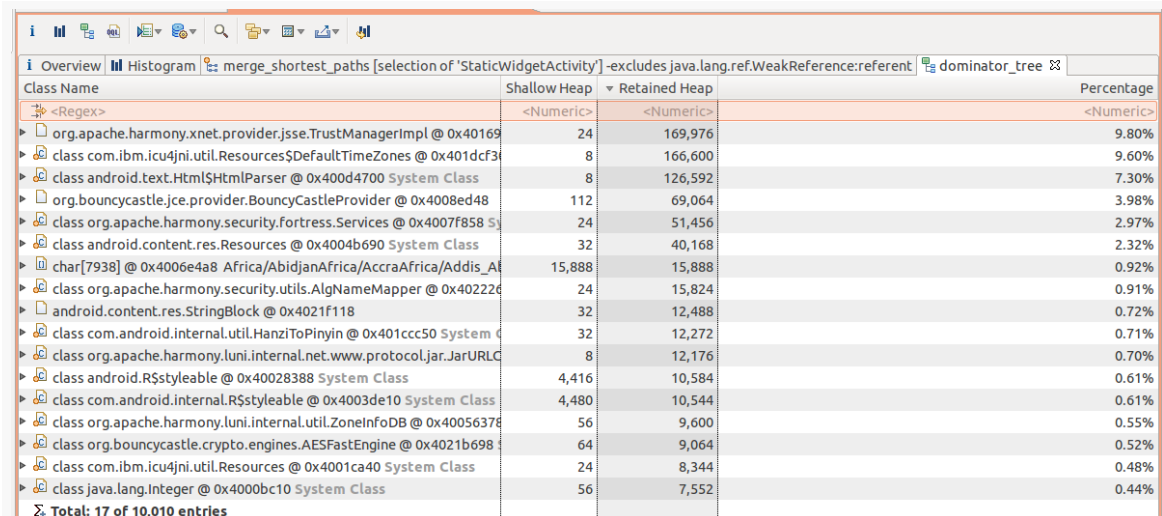
To get to the dominator tree, you can click its link on the Overview tab, or you can click the corresponding toolbar button:



*Figure 499: The icon used for the Dominator Tree toolbar button*

## FINDING MEMORY LEAKS WITH MAT

This will open up another tab in the same tool, showing “the biggest objects” by retained heap:



The screenshot shows the MAT Dominator Tree tab. The table lists various classes and their memory usage. The columns are Class Name, Shallow Heap, Retained Heap, and Percentage. The total memory usage is 10,010 entries.

Class Name	Shallow Heap	Retained Heap	Percentage
<Regex>	<Numeric>	<Numeric>	<Numeric>
org.apache.harmony.xnet.provider.jsse.TrustManagerImpl @ 0x40169...	24	169,976	9.80%
class com.ibm.icu4jni.util.Resources\$DefaultTimeZones @ 0x401dcf3...	8	166,600	9.60%
class android.text.Html\$HtmlParser @ 0x400d4700 System Class	8	126,592	7.30%
org.bouncycastle.jce.provider.BouncyCastleProvider @ 0x4008ed48	112	69,064	3.98%
class org.apache.harmony.security.fortress.Services @ 0x4007f858 Sy	24	51,456	2.97%
class android.content.res.Resources @ 0x4004b690 System Class	32	40,168	2.32%
char[7938] @ 0x4006e4a8 Africa/AbidjanAfrica/AccraAfrica/Addis_A	15,888	15,888	0.92%
class org.apache.harmony.security.utils.AlgNameMapper @ 0x40222e...	24	15,824	0.91%
android.content.res.StringBlock @ 0x4021f118	32	12,488	0.72%
class com.android.internal.util.HanziToPinyin @ 0x401ccc50 System C	32	12,272	0.71%
class org.apache.harmony.luni.internal.net.www.protocol.jar.JarURLC	8	12,176	0.70%
class android.R\$styleable @ 0x40028388 System Class	4,416	10,584	0.61%
class com.android.internal.R\$styleable @ 0x4003de10 System Class	4,480	10,544	0.61%
class org.apache.harmony.luni.internal.util.ZoneInfoDB @ 0x40056378	56	9,600	0.55%
class org.bouncycastle.crypto.engines.AESFastEngine @ 0x4021b698	64	9,064	0.52%
class com.ibm.icu4jni.util.Resources @ 0x4001ca40 System Class	24	8,344	0.48%
class java.lang.Integer @ 0x4000bc10 System Class	56	7,552	0.44%
Σ Total: 17 of 10,010 entries			

Figure 500: The MAT Dominator Tree tab

You can display more by right-clicking over the Total row at the bottom and choosing “Next 25”.

Here too, the roster will mostly be system objects (e.g., `org.bouncycastle` for the `javax.crypto` implementation). What you would be looking for are objects that you might be interacting with more directly that perhaps you are leaking, such as a `Bitmap`.

If you find something of interest, right-clicking over the object and choosing “Path to GC Roots” or “Merge Shortest Paths to GC Roots” will help you track down what is holding onto the object, akin to the similar feature in the Histogram.

## Some Leaks and Their MAT Analysis

Let’s now take a look at some common leak scenarios in Android and see how we find out whether we have a leak and what is causing it. All of the projects demonstrated below are in the MAT directory of the book’s source code.

### Widget in Static Data Member

The screen shots from above are mostly taken from the [MAT/StaticWidget](#) sample project, where we do something naughty:

```
package com.commonware.android.tuning.mat;

import android.app.Activity;
import android.os.Bundle;
import android.view.View;

public class StaticWidgetActivity extends Activity {
    @SuppressWarnings("unused")
    static private View doNotDoThisPlease;

    @Override
    public void onCreate(Bundle savedInstanceState) {
        super.onCreate(savedInstanceState);
        setContentView(R.layout.main);

        doNotDoThisPlease=findViewById(R.id.make_me_static);
    }
}
```

We take a widget (specifically the auto-generated `TextView`) and put it in a static data member, and never replace it with `null`.

As a result, even if the user presses `BACK` to get out of the activity, the static data member holds onto `TextView`, which itself has a reference back to our `Activity`.

Usually, you will pick this sort of leak up by scanning on your own application's package, as your activity will appear in there. If you are using multiple packages in your application (e.g., yours and a third-party activity), you might need to also check the third-party package to see if any of its objects are being leaked. Whether those leaks are the fault of your code or the third party's own code will vary, of course.

### Leaked Thread

You can see similar results when you leak a thread, such as in the [MAT/LeakedThread](#) sample project:

```
package com.commonware.android.tuning.mat;

import android.app.Activity;
import android.os.Bundle;
import android.os.SystemClock;
```

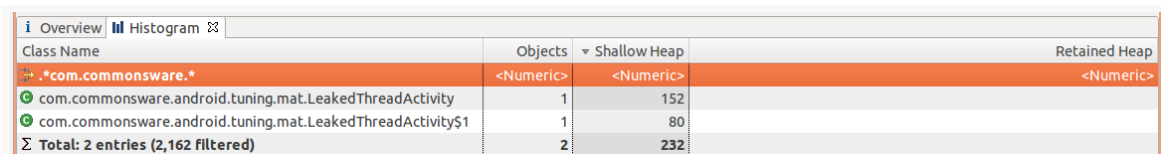


## FINDING MEMORY LEAKS WITH MAT

```
public class LeakedThreadActivity extends Activity {
    @Override
    public void onCreate(Bundle savedInstanceState) {
        super.onCreate(savedInstanceState);
        setContentView(R.layout.main);

        new Thread() {
            public void run() {
                while(true) {
                    SystemClock.sleep(100);
                }
            }
        }.start();
    }
}
```

Here, if we filter on `com.commonsware` in the Histogram, we see two entries:

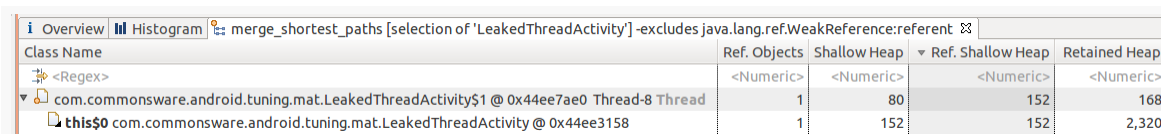


Class Name	Objects	Shallow Heap	Retained Heap
.*com.commonsware.*	<Numeric>	<Numeric>	<Numeric>
com.commonsware.android.tuning.mat.LeakedThreadActivity	1	152	
com.commonsware.android.tuning.mat.LeakedThreadActivity\$1	1	80	
Σ Total: 2 entries (2,162 filtered)	2	232	

Figure 501: The `LeakedThreadActivity` Histogram

As with other places in Java (e.g., stack traces), the `$` syntax in a class name refers to an inner class, and `$1` refers to the first anonymous inner class.

If we look at the GC roots for the activity, we see:



Class Name	Ref. Objects	Shallow Heap	Ref. Shallow Heap	Retained Heap
<Regex>	<Numeric>	<Numeric>	<Numeric>	<Numeric>
com.commonsware.android.tuning.mat.LeakedThreadActivity\$1 @ 0x44ee7ae0 Thread-8 Thread	1	80	152	168
this\$0 com.commonsware.android.tuning.mat.LeakedThreadActivity @ 0x44ee3158	1	152	152	2,320

Figure 502: The GC roots for `LeakedThreadActivity`

The root is a thread, as denoted by the “Thread” annotation on the end of the root entry. We see that the Thread object itself is our `$1` inner class instance, and it holds onto the activity via the implicit reference every non-static inner class has to its outer class instance (`this$0`).

Any running thread will cause anything it can reach to remain in the heap and not get garbage collected. An inner class implementation of the Thread — which most code examples will use, in one form or fashion — will leak the outer class instance. Hence, the lessons to be learned here are:

## FINDING MEMORY LEAKS WITH MAT

1. Leaking threads leaks memory
2. Consider using static inner classes, or separate classes, rather than non-static inner classes, so you do not cause objects to be held onto unnecessarily and unexpectedly

### All Sorts of Bugs

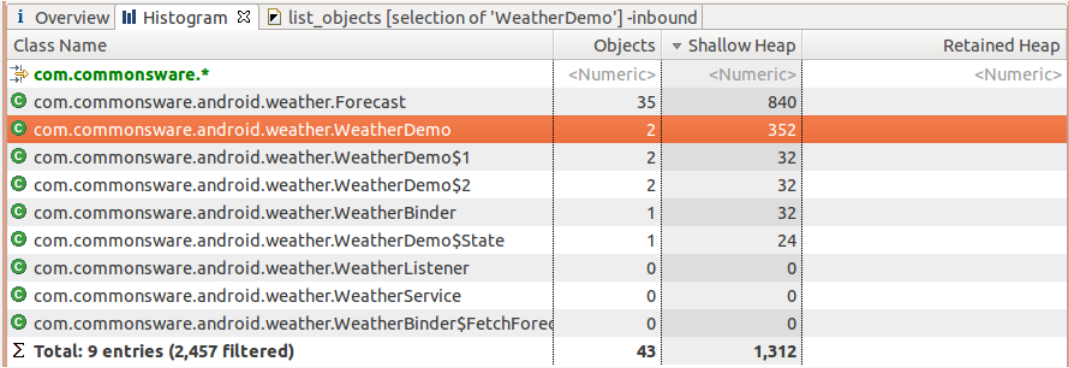
Let's now examine the [MAT/RandomAppOfCrap](#) sample application. This is a variation on an example from elsewhere in this book, showing using a bound service that connects to a Web service — in this case, the US National Weather Service. In this modified version, a number of leak-related bugs were introduced.

### Leaks Via Configuration Changes

The WeatherDemo activity implements `onRetainNonConfigurationInstance()`, returning a State object. State is an inner class of WeatherDemo, but not a static inner class.

This is not a good idea.

When you search the Histogram for `com.commonsware` after loading a weather forecast (e.g., run the app and use DDMS to push over a location fix) and rotating the screen, you see that there are two instances of WeatherDemo floating around the heap:



Class Name	Objects	Shallow Heap	Retained Heap
<b>com.commonsware.*</b>	<Numeric>	<Numeric>	<Numeric>
com.commonsware.android.weather.Forecast	35	840	
<b>com.commonsware.android.weather.WeatherDemo</b>	<b>2</b>	<b>352</b>	
com.commonsware.android.weather.WeatherDemo\$1	2	32	
com.commonsware.android.weather.WeatherDemo\$2	2	32	
com.commonsware.android.weather.WeatherBinder	1	32	
com.commonsware.android.weather.WeatherDemo\$State	1	24	
com.commonsware.android.weather.WeatherListener	0	0	
com.commonsware.android.weather.WeatherService	0	0	
com.commonsware.android.weather.WeatherBinder\$FetchFore	0	0	
<b>Σ Total: 9 entries (2,457 filtered)</b>	<b>43</b>	<b>1,312</b>	

*Figure 503: The com.commonsware objects in the RandomAppOfCrap heap*

To figure out what those objects are, you can right-click over a class in the Histogram and choose “List Objects” from the context menu. The fly-out sub-menu will let you choose to show incoming references (who points to these objects) or

## FINDING MEMORY LEAKS WITH MAT

outgoing references (what these objects point to). In this case, showing incoming references will bring up the following:

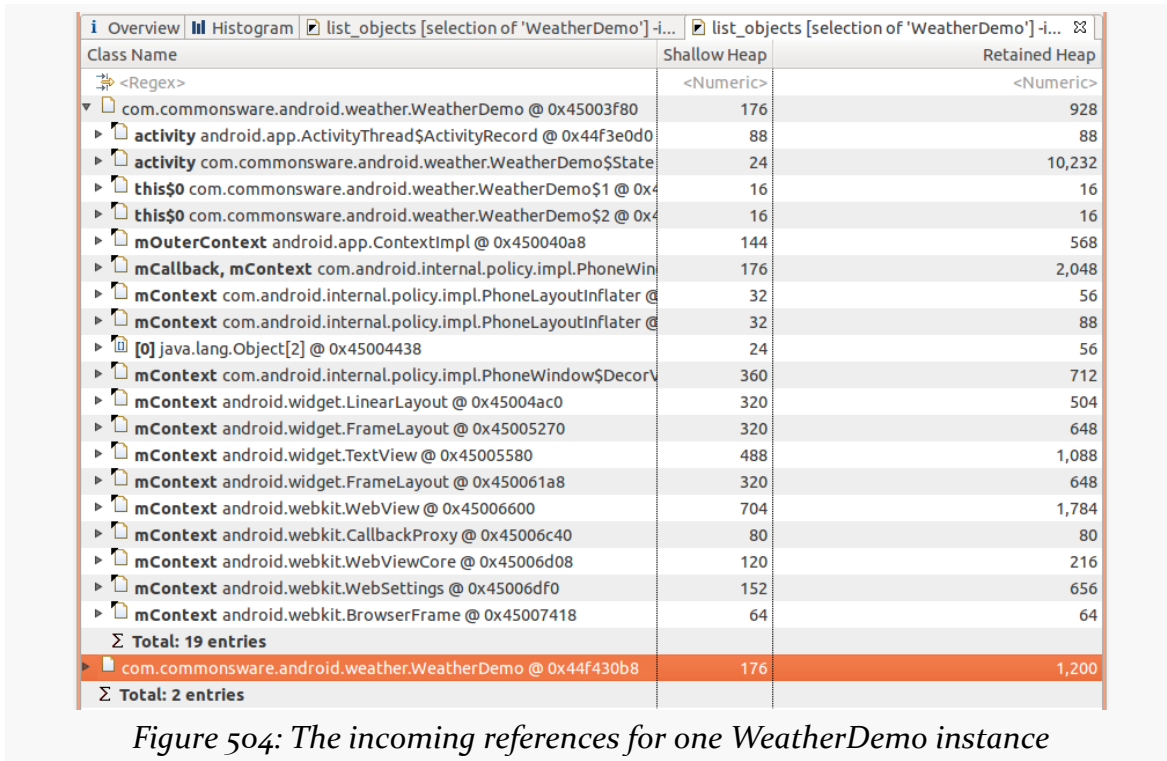


Figure 504: The incoming references for one WeatherDemo instance

## FINDING MEMORY LEAKS WITH MAT

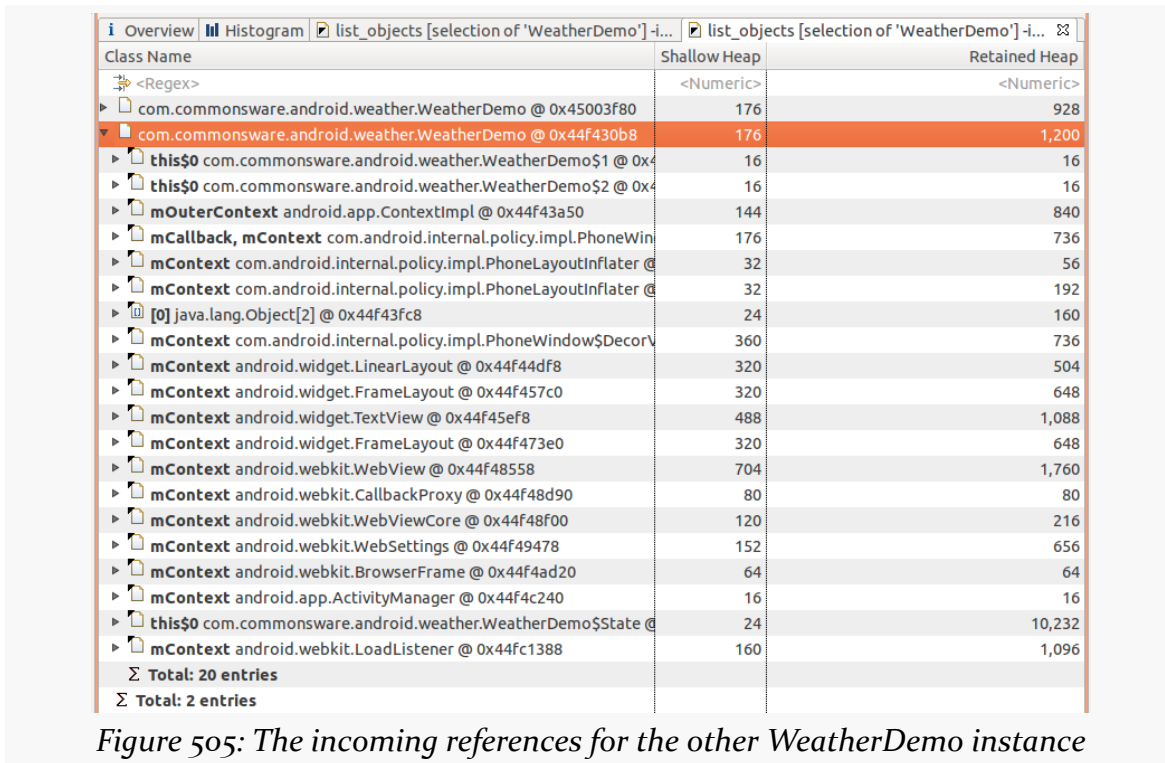


Figure 505: The incoming references for the other WeatherDemo instance

The eight-digit hex numbers shown after the @ sign are the object identifiers for each of the referred-to objects. You can use this to distinguish which objects are the same.

What you will notice is that both WeatherDemo instances are pointed to by the State object. In one, it is referred to by the activity data member. In the other, it is referred to by this\$0 — the implicit reference an inner class instance has on the outer class instance. Since both WeatherDemo instances hold onto the State via the state data member, this means that one WeatherDemo instance (the foreground one) is holding an indirect reference, via the State, to the other now-destroyed WeatherDemo instance. This is a leak.

The solution for this would be to use a static inner class for State, eliminating the implicit reference and breaking this connection.

### Leaks from Unregistered System Listeners

We also see from our filtered Histogram that we have two retained instances of the \$1 inner class. Displaying incoming references to those objects shows us that those are the LocationListener objects we are using to get our GPS fixes:

## FINDING MEMORY LEAKS WITH MAT

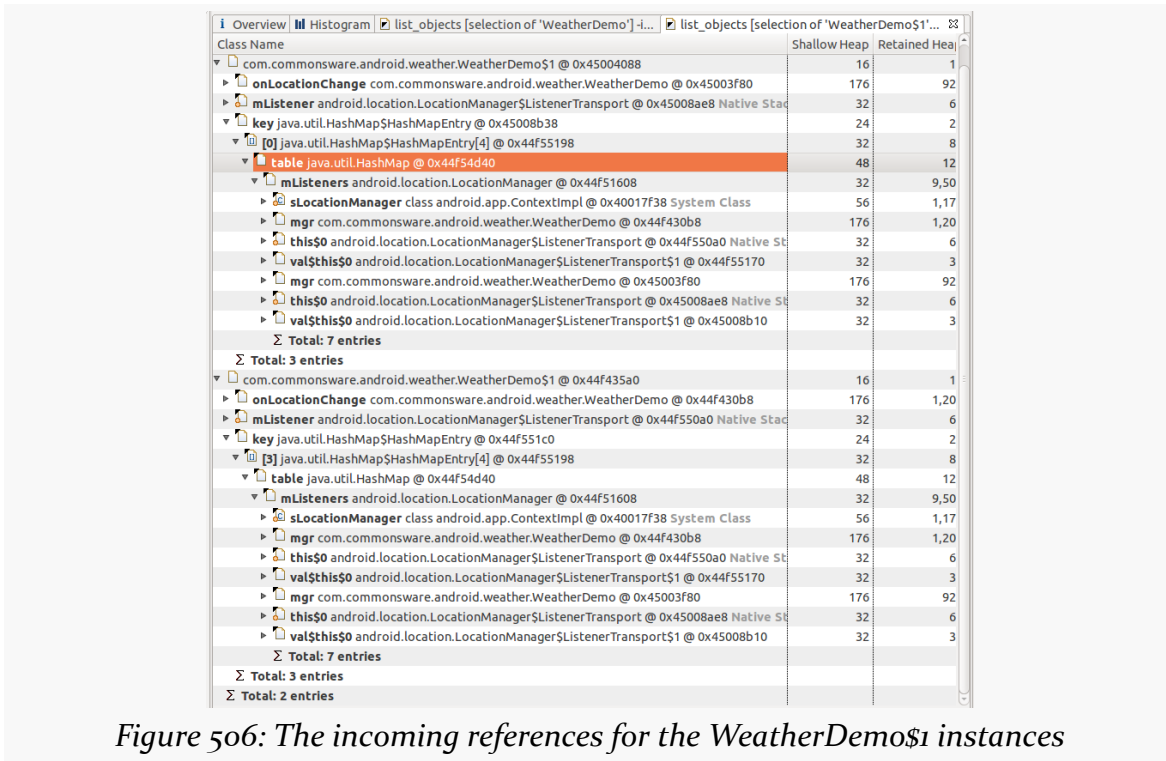


Figure 506: The incoming references for the WeatherDemo\$1 instances

Tracing through the incoming references, we see that the ContextImpl class holds a static reference to the LocationManager system service in our process, and LocationManager has an mListeners data member which is a list of all registered LocationListener instances.

Alas, in WeatherDemo, we are registering a LocationListener and never unregistering it. Since our LocationListener is an inner class, not only is the LocationListener itself leaked, but it prevents our destroyed WeatherDemo object from being garbage collected.

This same pattern can be seen for many of the system services — if you register a listener, you must ensure that you unregister it to prevent leaks.

### What MAT Won't Tell You

MAT is not a universal solution. It may not tell you of all possible leaks.

For example, if you bind to a service, the ServiceConnection object you create is held onto, indirectly, by the OS itself. That is how you can use the ServiceConnection to unbind from the service later on. However, if you examine

## FINDING MEMORY LEAKS WITH MAT

---

MAT, you will see no evidence of this, as MAT is limited to examining *your own* process and cannot report about references that are triggered by other processes.

MAT also will not report anything that is part of the native heap (i.e., what you get with a C `malloc()` call) — it only reports on the Dalvik heap. Hence, MAT will not reflect the actual memory consumption of bitmap images on Gingerbread and earlier environments. You may wish to do some testing of your app on Honeycomb, not just for any tablet support you may offer, but to get more complete results from MAT.



# Issues with Battery Life

---

Most Android devices are powered by batteries — Google TV is the biggest class of device that is not. Batteries are wonderful gizmos with one major problem: they are *always* running out of power.

Hence, users are very sensitive to battery consumption. Their ability to use their phones as actual *phones*, let alone for Android apps, depends on having enough battery power. The more apps drain the battery, the more frequently the user has to find a way to recharge the phone, and the more frequently the user fails and their phone shuts down.

The catch is that you may not notice the battery issues in your day-to-day development. The Android emulator's emulated battery does not drain based on you running your app. Your devices are often connected to your development machine via USB for testing and debugging, meaning they are perpetually being charged. Unless you are a regular user of your own app, you might not notice any increased power drain.

This part of the book is focused on helping you understand what is draining power and what you can do to be kinder and gentler on your users' batteries.

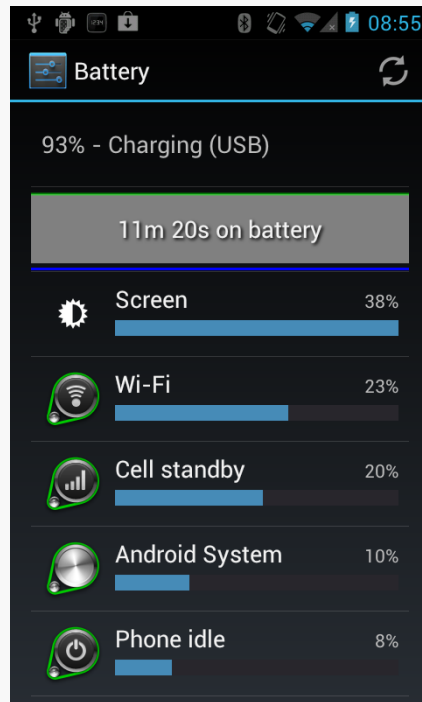
## Prerequisites

Understanding this chapter requires that you have read the core chapters and understand how Android apps are set up and operate.



## You're Getting Blamed

Users, for better or worse, have limited ability to determine what is responsible for draining the battery of their phone. Their #1 tool for this is the “Power Usage Summary” screen in the Settings app, sometimes referred to as the “battery blame screen”.



*Figure 507: Battery Screen from Settings App*

This lists both device features (e.g., the display) and applications. Android incrementally improves the accuracy of this screen with each passing release, trying to make sure the user understands what specifically is consuming the power.

If your application starts appearing on this screen, and the user does not feel that it is justified, the user is likely to become irritated with you.

Now, your appearance on this list might be perfectly reasonable. If you have written a video player app, and the user has just watched a few hours' worth of video, it is very likely that you will appear on this list and will be justified in your battery consumption.

However, anything that you can do to not appear on this screen, or appear lower in the list, will help with user acceptance of your app.

This part of the book will show you how to measure your power usage and ways of trying to use less of it.

### **Stretching Out the Last mWh**

Sometimes, what the user wants your app to do in one case is not what the user wants your app to do in other cases. Serious power-draining might be reserved for when the device is plugged in, or when the device has at least such-and-so power remaining. The user may value the last milliwatt-hours (mWh) more than others and want your application to use less power in those circumstances.

Hence, if your application polls the Internet, you might offer a feature to poll less frequently, or perhaps not at all, when power is low. If your application uses GPS to find a location (e.g., automatic “check-ins” to social networks like Foursquare), you might offer to skip such actions when the battery is low. You might want to signal to the user when the battery gets low during playback of a video, or during the game they are in. And so on.

This part of the book will help you identify when the battery is low and strategies for making use of that information.



# Focus On: MDP and Trepn

---

You can measure power drain in one of two ways:

1. Rip open a device enough to hook up a multi-tester to the proper leads to measure physically on the device how much power is being drained from the battery. You will need to either get a very sophisticated recording multi-tester, or perhaps cross-train a court stenographer to be able to record the power levels consumed as fast as possible.
2. You find a device that can do this sort of recording automatically.

Since recording multi-testers and court stenographers are expensive, you might head in the latter direction. Fortunately, Qualcomm makes a series of devices — the Mobile Development Platform, or MDP – that can record real-time power consumption. Qualcomm also makes a tool that can interpret this information, called Trepn.

In this chapter, we will examine the MDP and Trepn in greater detail, so you can determine what sorts of information this device can give you.

## Prerequisites

Understanding this chapter requires that you have read the core chapters, particularly the chapter on [working with the Internet](#).

## What Are You Talking About?

It is very likely that even seasoned Android developers will have never heard of MDP or Trepn. You will not find an MDP in your local electronics store. You will not even

find them on eBay (most of the time). And since Trepn is largely useless without access to an MDP's power recordings, only those who have run across an MDP are likely to have also heard of Trepn.

Of course, since you are reading this book, it is clear that you are an exemplary Android developer, one thirsting for knowledge and who therefore might be interested in learning more about these hidden gems.

### What's an MDP?

The Qualcomm MDP is a mobile phone, but not one designed for consumer use. Rather, it is a reference platform for a Qualcomm mobile CPU. There are two MDP models, one each for two Qualcomm processors: the MSM8660 and the MSM8655.

As a reference platform, this device is not necessarily designed to be regularly used. Instead, it is designed to show off a number of advanced hardware capabilities and allow developers to test on them. For example, the MDP for the MSM8660 has:

1. Dual cores (1.5GHz each)
2. 1080p video recording and playback
3. 3D output via HDMI
4. a 13 megapixel main camera

These are all at or above most mainstream devices, as of the device's release in late spring 2011.

The MDP also has additional instrumentation designed to assist with testing applications, and that is where Trepn comes in.

### What's a Trepn?

The MDP has specialized hooks in the firmware to monitor power consumption by various components: CPU, radios, display, etc. Trepn is an application, built into the MDP, that can collect, record, and display that data and related information. Developers can use Trepn to determine how much power their application uses while it runs through a test suite, for example.

Trepn runs on the device itself, though it does save its results as CSV files for possible offline analysis. Trepn, therefore, is not something that you run on your development machine or in your Web browser, but on the MDP itself.

## The Big Problem: Cost

The MDP MSM8660, at the time of this writing, runs nearly \$1,400. This means that few Android application developers will have direct hands-on access to the MDP.

A previous version of the MDP also had issues with the purchase agreement you had to abide by when obtaining an MDP from BSQUARE (Qualcomm's retailer/front-line support firm for the MDP). For example, the purchase agreement would have forbidden this chapter from being published, as it includes results from running tests on the MDP. However, the purchase agreement for the MSM8660 MDP is more reasonable.

## Running Trepn Tests

Measuring your power consumption using Trepn is fairly straightforward, particularly for simple cases... with one big limitation.

First, you will need to get your app on the MDP. You may even wish to run the app once on the MDP — if your concerns are power consumption over the long haul, getting all of your app initialization logic done before you start measuring power is probably a good move.

Next, run the “Trepn Profiler” application on the MDP, found in the launcher like any other activity.

(NOTE: Due to limitations in the MDP hardware, screenshots of Trepn are not available)

Then, click the “Begin Profiling” button. This will bring up a dialog box where you can select an application on the MDP that Trepn should launch and monitor.

Note that this means you cannot readily use Trepn to measure the power consumed by a unit test suite or other form of instrumentation. You may wish to organize your code into an Android library project with a separate project for the UI front end, with additional projects for testing various power consumption scenarios that you use with Trepn.

Once you choose an application and click the Start button in the dialog, Trepn will gather a few seconds of “warmup” data, then run your app. You are welcome to interact with your application at this point, if your app is interactive and you have

not otherwise automated the testing. When you are done, return to the Trepn Profiler activity (e.g., through the Notification in the status bar) and click the “Stop Profiling” button. You will be prompted for the name of a directory in which to save the data.

And that’s it!

## Recording Application States

The problem is, Trepn does not intrinsically know much about your application. It is simply recording power usage while your application is running. Trepn has no way of knowing when certain features of your app are used or certain calculations are run.

Unless you tell it.

You can send a broadcast Intent that Trepn will pick up, indicating what “application state” your app is now in. Here, an “application state” is simply some integer — it will be up to you to map integers to various portions of your application logic (e.g., 1 is normal, 2 is during your data download, 3 is during your data export process). If you tell Trepn the states of your application, it will not only record the overall results but the “splits” for each one of your states.

For example, the [Power/Downloader](#) sample application is a modified version of one from an earlier edition [of this book](#). The earlier sample app had a large button — clicking the button would kick off a download of a PDF file in a background thread via an IntentService. This book’s version of the sample skips the button — launching the activity will introduce a five-second pause, then the download will begin automatically. The activity will be finished once the download is complete.

Along the way, we let Trepn know when the download work begins:

```
@Override
public void onHandleIntent(Intent i) {
    Intent trepn=new Intent("com.quicinc.Trepn.UpdateAppState");

    trepn.putExtra("com.quicinc.Trepn.UpdateAppState.Value",
                  1337);
    sendBroadcast(trepn);

    // rest of method here
}
```

You need to create an Intent for the `com.quicinc.Trepn.UpdateAppState` action, add an extra with your integer keyed as `com.quicinc.Trepn.UpdateAppState.Value`, then send the broadcast.

The fact that Trepn uses broadcasts here means you will want your application states to be fairly coarse-grained. You cannot realistically update the state more than once every couple of seconds, and the asynchronous nature of sending broadcasts means that your work might begin before the state itself is recorded.

## Examining Trepn Results

You have two ways to look at the data that Trepn collects. There is an on-device UI, integrated as part of the Trepn application. Or, you can grab the raw data and perform your own offline analysis using your choice of tools.

### On-Device

Either before stopping profiling, or by reloading the Trepn session via the “View Saved Sessions” button, you can view a graph of power consumption, or click “View Stats” for a tabular rendition of the data.

By default, Trepn will record a handful of values, such as the power consumed overall and by the two CPU cores. In the Trepn settings activity, though, you can toggle on or off any number of other values to record, plus indicate if they should be displayed in the resulting graph.

Both the graph and the table will show your application states. On the graph, the changes in your application state value will be graphed along with everything else. The table will show how much time and power was consumed in each of your states — probably a more valuable means of interpreting the results.

### Off-Device

If you browse the external storage of the MDP, you will find a `trepn` directory that contains the saved sessions from your tests:



## FOCUS ON: MDP AND TREPn

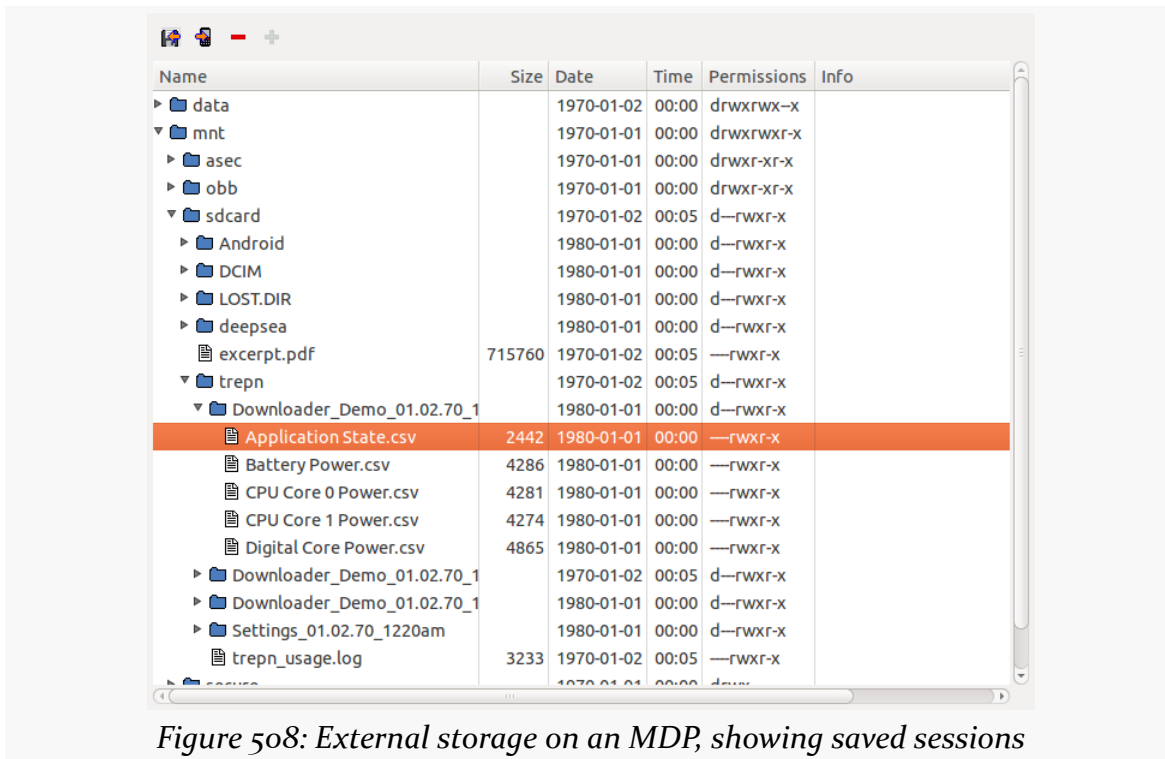


Figure 508: External storage on an MDP, showing saved sessions

For each collected statistic for each saved session, there will be a CSV file containing the raw data. The columns for the CSV file will vary by statistic, though all will have a time offset column to indicate when the value was recorded.

For example, here is an extract from the Battery Power .csv file from one Trepn run with ellipses added to show where portions of the file were removed for brevity:

```
Time (ms),Battery Power (uA),Battery Power (uW)
-4914,2600,10784
-4814,2600,10784
-4714,2600,10784
...
-104,2600,10784
-2,2600,10784
99,2600,10784
198,2600,10784
299,2600,10784
...
5024,2600,10784
5125,2600,10784
5224,2600,10784
5325,2600,10784
5427,2600,10784
5525,2600,10784
```

## FOCUS ON: MDP AND TREP

---

```
5630,2600,10784
5732,2600,10784
5833,2600,10784
5931,39800,165090
6031,3000,12443
6134,2600,10784
6234,2600,10784
...
```

Time values less than 0 represent the “warmup” period before Trepn actually runs your application. In this case, the battery power is shown both in micro-amps (uA) and micro-watts (uW).

To correlate these events with your application states, you will also need to examine the Application State.csv file:

```
Time (ms),Application State
-4950,0
-4849,0
-4749,0
...
-134,0
-34,0
66,0
167,0
267,0
367,0
...
5092,0
5136,1337
5193,1337
5293,1337
5393,1337
5494,1337
5594,1337
5694,1337
5794,1337
5895,1337
5996,1337
6096,1337
6196,1337
6297,1337
...
```

The time offsets will not line up precisely (for whatever reason), but will show the saved application state value at the specific offsets. So, between 5.092 and 5.136 seconds after the actual test began, our application state shifted from the default to 1337, corresponding to the value we sent over in the broadcast Intent extra. All power levels after that point would be related to the download operation.

## **FOCUS ON: MDP AND TREP**

---

In principle, one could import these into a spreadsheet or craft tools to parse the CSV data and create other visual representations, particularly in ways that can be used without the MDP being around.

# Other Power Measurement Options

---

Given the sheer expense of the Qualcomm MDP, few developers will have direct access to one, despite the detailed power statistics one can glean from Trepn. There are free alternatives, but they all have substantial limits when compared to the combination of the MDP and Trepn.

## Prerequisites

Understanding this chapter requires that you have read the core chapters and understand how Android apps are set up and operate.

## PowerTutor

Perhaps the best-known third-party power analyzer is [PowerTutor](#). PowerTutor is the outcome of a research project from the University of Michigan, with a bit of assistance from Google. In principle, PowerTutor is capable of letting you know power consumption on a device, much along the lines of what Trepn can record on a Qualcomm MDP. In practice, PowerTutor is significantly less powerful and sophisticated.

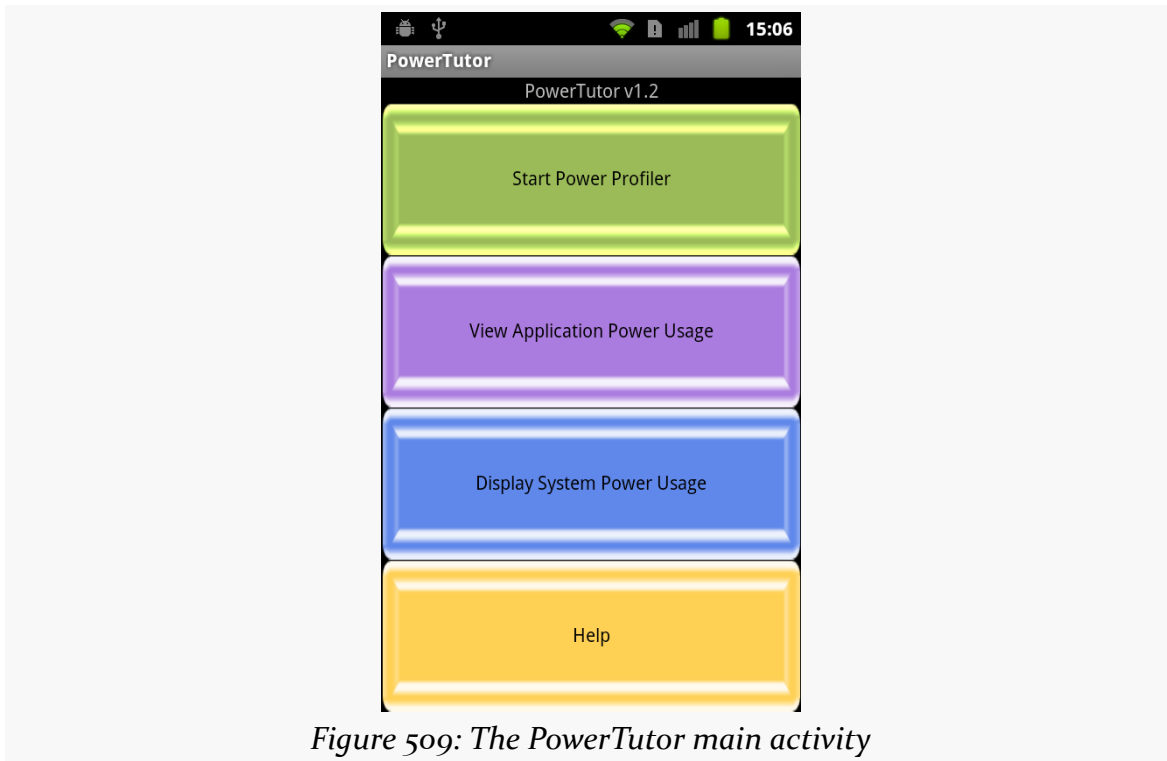
PowerTutor was created with the HTC Dream (T-Mobile G1), HTC Magic (T-Mobile G2), and Nexus One in mind. Its power output values will be as accurate as they could make it for those devices. If you run PowerTutor on other hardware, the results will be less accurate.

You can obtain PowerTutor from the Play Store, or from the PowerTutor Web site, or you can [compile it from source](#).

## OTHER POWER MEASUREMENT OPTIONS

---

PowerTutor is not tied to testing a particular application. As such, you can simply run PowerTutor whenever you want from its launcher icon, then press “Start Power Profiler” in the main activity:

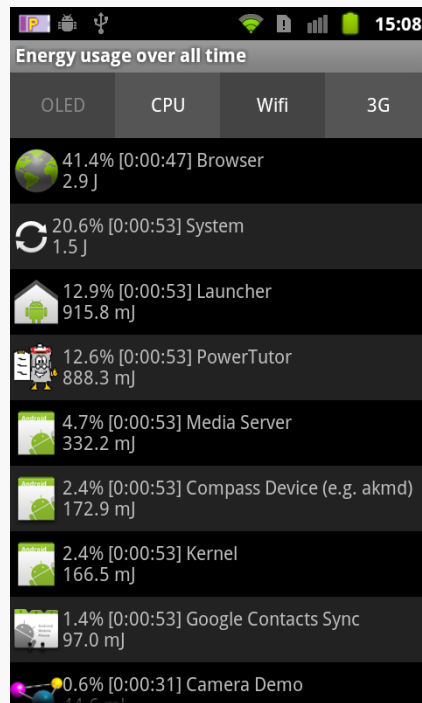


*Figure 509: The PowerTutor main activity*

At this point, you can start playing with your application, or running your unit test suite, or whatever. When you want to get an idea of how much power you have been consuming, you can switch back to the PowerTutor activity and choose “View Application Power Usage”. This brings up a list of processes and toggle buttons to show various power consumption values for each:

## OTHER POWER MEASUREMENT OPTIONS

---

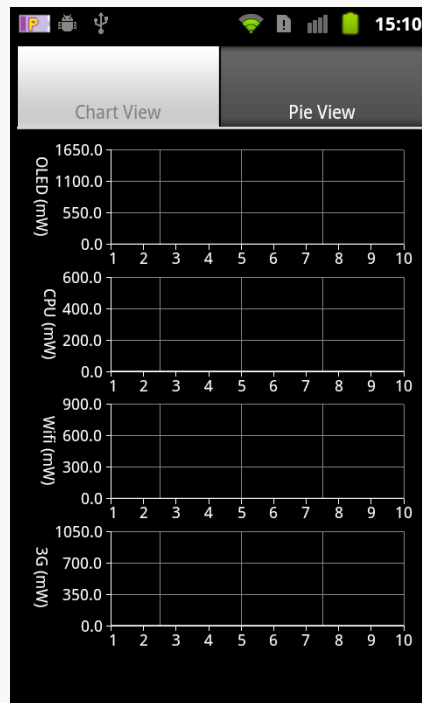


*Figure 510: The PowerTutor application roster*

Tapping the list entry brings up a graph for that particular process, though since this information is only available while PowerTutor is recording new data, the graph is usually empty unless you have logic running in the background:

## OTHER POWER MEASUREMENT OPTIONS

---

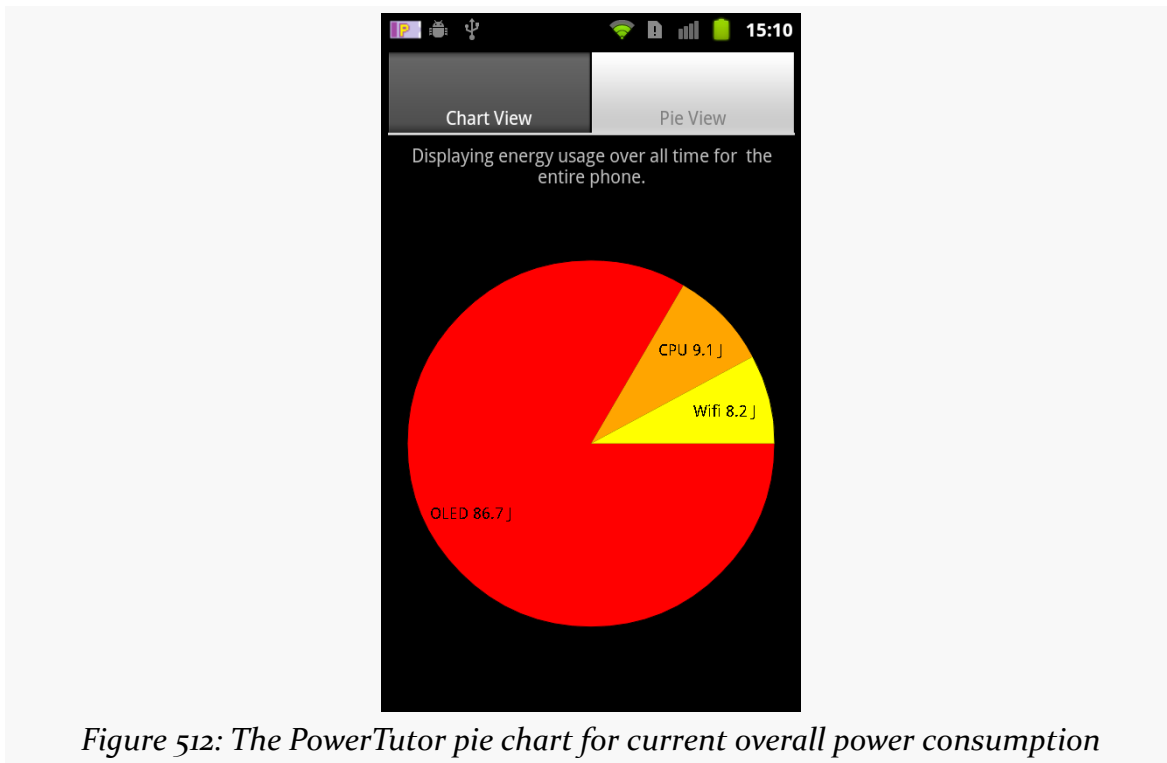


*Figure 511: The PowerTutor live charts for a single process current power consumption*

You can also bring up a charts showing what portion of your power consumption came from various sources for the whole device, such as a pie chart of current consumption:

## OTHER POWER MEASUREMENT OPTIONS

---



Given that the source code is available, one might augment PowerTutor to:

1. Saving results, both as data files for offline analysis (akin to Trepn's CSV files) or for viewing charts and tables on the device when data is not being actively collected
2. Allowing one to record application states, akin to Trepn, to better correlate application functionality to saved power results

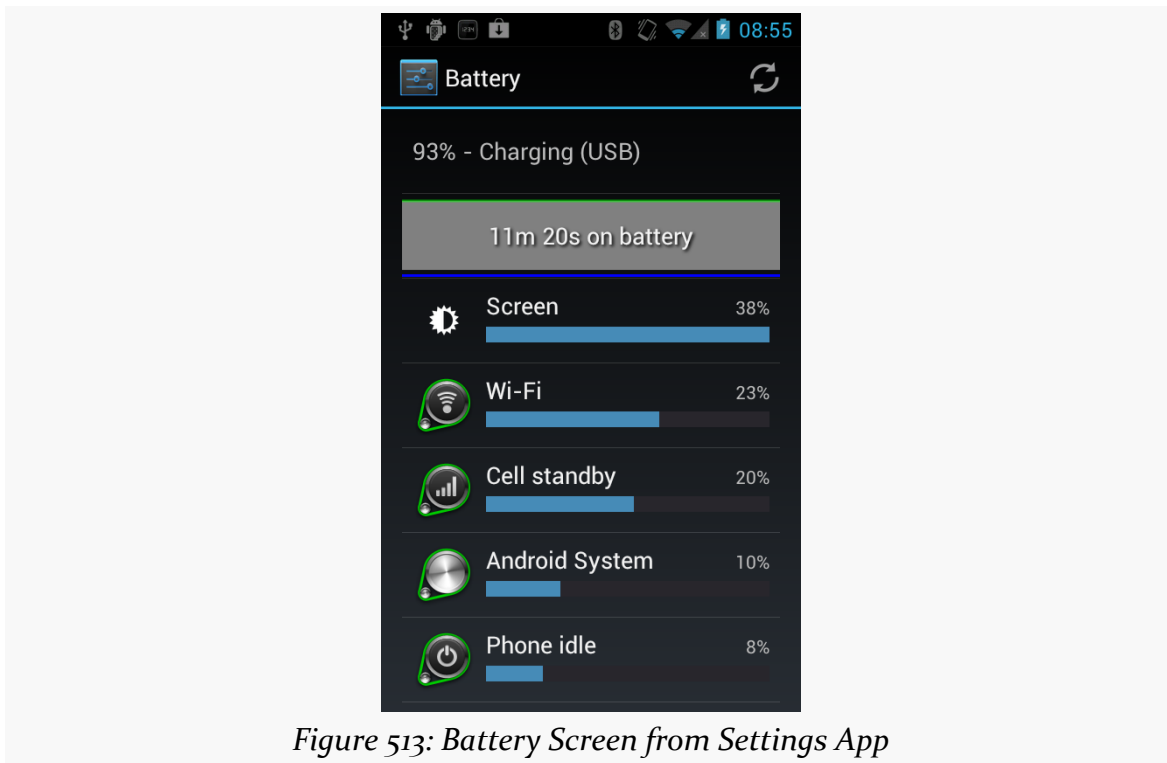
## Battery Screen in Settings Application

Of course, what developers tend to focus on most with power is the battery consumption screen in the Settings application, as shown in [a previous chapter](#):



## OTHER POWER MEASUREMENT OPTIONS

---



*Figure 513: Battery Screen from Settings App*

After all, this is what users will tend to focus on — anything showing up in here is a source of blame for whatever power woes the user believes she is experiencing. Conversely, if your application does not show up in this screen during normal operation, then there is no compelling reason for you to do further analysis, as users will tend to be oblivious to your actual power consumption.

If you do show up in the list, tapping on your entry can give you some more details of what power you consumed and why:

## OTHER POWER MEASUREMENT OPTIONS

---

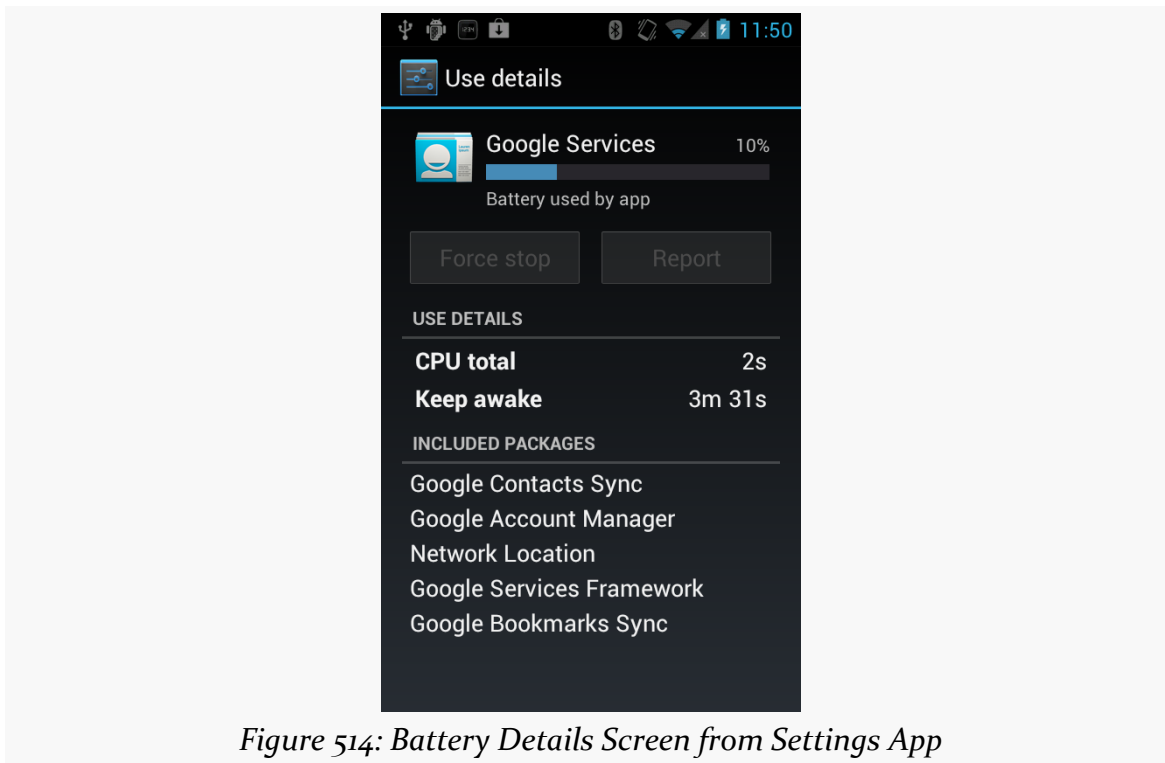


Figure 514: Battery Details Screen from Settings App

## BatteryInfo Dump

Yet another possibility is to use the `adb shell dumpsys batteryinfo` command from your command prompt or terminal on your development workstation. This will emit a fair amount of data that probably means something to somebody, such as general device information:

```
Battery History:
-1h00m56s463ms 096 20030002 status=discharging health=good
plug=none temp=191 volt=4060 +screen +wake_lock +sensor
brightness=medium
-1h00m52s490ms 096 22030302 +wifi phone_state=off
-1h00m51s844ms 096 2703d102 +phone_scanning +wifi_running
phone_state=out data_conn=other
-1h00m49s303ms 096 2743d102 +wifi_scan_lock
-57m48s766ms 095 2743d102
-53m24s627ms 095 2743d100 brightness=dark
-53m17s620ms 095 0741d100 -screen -wake_lock
-53m17s107ms 095 0740d100 -sensor
-38m17s007ms 095 0642d100 -wifi_running +wake_lock
-38m08s998ms 095 0640d100 -wake_lock
-54s781ms 095 4640d100 status=full plug=usb temp=193
volt=4084 +plugged
```

## OTHER POWER MEASUREMENT OPTIONS

---

### Per-PID Stats:

```
PID 96 wake time: +12s75ms
PID 177 wake time: +1s13ms
PID 458 wake time: +1s898ms
PID 326 wake time: +3s925ms
PID 205 wake time: +2s107ms
PID 415 wake time: +843ms
PID 96 wake time: +281ms
```

### Statistics since last charge:

```
System starts: 0, currently on battery: false
Time on battery: 1h 0m 1s 682ms (0.3%) realtime, 8m 21s 883ms
(0.0%) uptime
Total run time: 16d 11h 13m 34s 654ms realtime, 2h 9m 37s 404ms
uptime,
Screen on: 7m 37s 868ms (12.7%), Input events: 0, Active phone
call: 0ms (0.0%)
Screen brightnesses: dark 7s 7ms (1.5%), medium 7m 30s 861ms (98.5%)
Kernel Wake lock "SMD_DS": 2s 368ms (3 times) realtime
Kernel Wake lock "mmc_delayed_work": 1s 210ms (1 times) realtime
Kernel Wake lock "SMD_RPCCALL": 56ms (435 times) realtime
Kernel Wake lock "power-supply": 575ms (4 times) realtime
Kernel Wake lock "radio-interface": 3s 1ms (3 times) realtime
Kernel Wake lock "ApmCommandThread": 4ms (10 times) realtime
Kernel Wake lock "ds2784-battery": 2s 6ms (21 times) realtime
Kernel Wake lock "msmfb_idle_lock": 14ms (2273 times) realtime
Kernel Wake lock "kgs1": 51s 482ms (613 times) realtime
Kernel Wake lock "rpc_read": 164ms (272 times) realtime
Kernel Wake lock "main": 7m 39s 708ms (0 times) realtime
Total received: 0B, Total sent: 0B
Total full wakelock time: 149ms , Total partial wakelock time: 31s
14ms
Signal levels: none 59m 57s 63ms (99.9%) 1x
Signal scanning time: 59m 57s 63ms
Radio types: none 641ms (0.0%) 1x, other 59m 56s 973ms (99.9%) 1x
Radio data uptime when unplugged: 0 ms
Wifi on: 59m 57s 709ms (99.9%), Wifi running: 22m 35s 424ms
(37.6%), Bluetooth on: 0ms (0.0%)
```

### Device battery use since last full charge

```
Amount discharged (lower bound): 0
Amount discharged (upper bound): 1
Amount discharged while screen on: 1
Amount discharged while screen off: 0
```

(... and lots more...)

and per-process information (here, showing power used by PowerTutor itself):

### #10058:

```
Wake lock window: 5s 71ms window (1 times) realtime
Proc edu.umich.PowerTutor:
```

## OTHER POWER MEASUREMENT OPTIONS

---

```
CPU: 11s 750ms usr + 4s 530ms krn
1 proc starts
Apk edu.umich.PowerTutor:
Service edu.umich.PowerTutor.service.UMLoggerService:
  Created for: 4m 4s 750ms uptime
  Starts: 1, launches: 1
```

In principle, one might create tools that use this output — or perhaps steal a peek at the data used by the Settings application – to create something a bit more developer-friendly.



# **The Role of Alternative Environments**

You might think that Android is all about Java. The official Android Software Development Kit (SDK) is for Java development, the build tools are for Java development, the discussion groups and blog posts and, yes, most books are for Java development. Heck, most of this book is about Java.

However (and with apologies to William Goldman), it just so happens that Android is only mostly Java. There's a big difference between mostly Java and all Java. Mostly Java is slightly not Java.

So, while Android's "sweet spot" will remain Java-based applications for the near term, you can still create applications using other technologies. This part of the book will take a peek at some of those alternatives.

This chapter starts with an examination of the [pros](#) and [cons](#) of Android's Java-centric strategy. It then enumerates some [reasons](#) why you might want to use something else for your Android applications. The downsides of alternative Android application environments – [lack of support](#) and [technical challenges](#) – are also discussed.

## **Prerequisites**

Understanding this chapter requires that you have read the core chapters and understand how Android apps are set up and operate.

## In the Beginning, There Was Java...

The core Android team made a fairly reasonable choice of language when they chose Java. It is a very popular language, and in the mobile community it had a clear predecessor in Java Micro Edition ([J2ME](#)). Lacking direct access to memory addresses (so-called “pointers”), a Java-based application will be less prone to developer errors leading to buffer overruns, resulting in possible hacks. And there is a fairly robust ecosystem around Java, in terms of educational materials, existing code bases, integrated development environments (IDEs), and so on.

However, while you can program Android in the Java language, an Android device does not run a Java application. Instead, your Java code is converted into something that runs on the “Dalvik virtual machine”. This is akin to the technology used for regular Java applications, but Dalvik is specifically tuned for Android’s environment. Moreover, it limits the dependency of Android on Java itself to a handful of programming tools, important as Java’s stewardship moves from Sun to Oracle to wherever.

That Dalvik virtual machine is also capable of running code from other programming languages, a feature that makes possible much of what this book covers.

## ... And It Was OK

No mobile development environment is perfect, and so the combination of Java and Android has its issues.

Java uses garbage collection to save people from having to keep track of all of their memory allocations. That works for the most part, and it is generally a boon to developer productivity. However, it is not a cure-all for every memory and resource allocation problem. You can still have what amounts to “memory leaks” in Java, even if the precise mechanics of those leaks differ from the classic leaks you get in C, C++, etc.

Most importantly, though, not everybody likes Java. It could be because they lack experience with it, or perhaps they have experience with it and did not enjoy that experience. Certainly, Java is slowly being considered as a language for big enterprise systems and, therefore, is not necessarily “cool”. Advocates of different languages will have their own pet peeves with Java as well (e.g., to a Ruby developer, Java is really verbose).

So, while Java was not a bad choice for Android, it was not perfect, either.

### Bucking the Trend

However, just because Java is the dominant way to build apps for Android, that does not mean it is the only way, and for you, it may not even be the best way.

Perhaps Java is not in your existing skill set. You might be a Web developer, more comfortable with HTML, CSS, and JavaScript. There are frameworks to help you with that. Or, maybe you cut your teeth on server-side scripting languages like Perl or Python — there are ways to sling that code on Android as well. Or perhaps you already have a bunch of code in C/C++, such as game physics algorithms, that would be painful to rewrite in Java — you should be able to reuse that code too.

Even if you would be willing to learn Java, it may be that your inexperience with Java and the Android APIs will just slow you down. You might be able to get something built much more quickly with another framework, even if you wind up replacing it with a Java-based implementation in the future. Rapid development and prototyping is frequently important, to get early feedback with minimal investment in time.

And, of course, you might just find Java programming to be irritating. You would not be the first, nor the last, to have that sentiment. Particularly if you are getting into Android as a hobby, rather than as part of your “day job”, having fun will be important to you, and you might not find Java to be much fun.

### Support, Structure

However, “friendly” and “fully supported” are two different things.

Some alternatives to Java-based development are officially supported by the core Android team, such as C/C++ development via the Native Development Kit (NDK) and Web-style development via HTML5.

Some alternatives to Java-based development are supported by companies. Adobe supports AIR, Nitobi supports PhoneGap, Rhomobile supports Rhodes, and so on. Other alternatives are supported by standards bodies, like the World Wide Web Consortium (W3C) supporting HTML5. Still others are just tiny projects with only the backing of a couple of developers.



You will need to make the decision for yourself which of these levels of support will meet your requirements. For many things, support is not much of an issue, but there will always be cases where support becomes paramount (e.g., enterprise application development).

### **Caveat Developer**

Of course, going outside the traditional Java environment for Android development has its issues, beyond just how much support might be available.

Some may be less efficient, in terms of processor time, memory, or battery life, than will development in Java. C/C++, on the whole, is probably better than Java, but HTML5 may be worse, for example. Depending on what you are writing and how heavily it will be used will determine how critical that inefficiency will be.

Some may not be available on all devices. Right now, Flash is the best example of this — some devices offer some amount of Flash support, while other devices have no Flash at all. Similarly, HTML5 support was only added to Android in Android 2.0, so devices running older versions of Android do not have HTML5 as a built-in option.

Every layer between you and officially supported environments makes it that much more difficult for you to ensure compatibility with new versions of Android, when they arise. For example, if you create an application using PhoneGap, and a new Android version becomes available, there may be incompatibilities that only the PhoneGap team can address. While they will probably address those quickly — and they may provide some measure of insulation to you from those incompatibilities — the response time is outside of your control. In some cases, that is not a problem, but in other cases, that might be bad for your project.

Hence, just because you are developing outside of Java does not mean everything is perfect. You simply have to trade off between these problems and the ones Java-based development might cause you. Where the balance lies is up to each individual developer or firm.

Prior to the current wave of interest in mobile applications, the technology *du jour* was Web applications. A lot of attention was paid to AJAX, Ruby on Rails, and other techniques and technologies that made Web applications climb close to the experience of a desktop application, and sometimes superior.

The explosion of Web applications eventually drove the next round of enhancements to Web standards, collectively called HTML5. Android 2.0 added the first round of support for these HTML5 enhancements. Notably, Android supports offline applications and Web storage, meaning that HTML5 becomes a relevant technique for creating Android applications, without dealing with Java.

## Prerequisites

Understanding this chapter requires that you have read the core chapters and understand how Android apps are set up and operate. Reading the [chapter on WebView](#) would be a good idea, as would reading the [introduction to this trail](#).

## Offline Applications

The linchpin for using HTML5 for offline applications — on Android or elsewhere — is the ability for those applications to be used when there is no connectivity, either due to problems on the client side (e.g., on an airplane sans WiFi) or on the server side (e.g., Web server maintenance).

### What Does It Mean?

Historically, Web applications have had this annoying tendency to require Web servers. This led to all sorts of workarounds for offline use, up to and including shipping a Web server and deploying it to the desktop.

HTML5 solves this problem by allowing Web pages to specify their own caching rules. A Web app can publish a “cache manifest”, describing which resources:

1. Can be safely cached, such that if the Web server is unavailable, the browser will just use the cached copy
2. Cannot be safely cached, such that if the Web server is unavailable, the browser should fail like it normally does
3. Have a “fallback” resource, such that if the Web server is unavailable, the cached fallback resource should be used instead

For mobile devices, this means that a fully HTML5-capable browser should be able to load all its assets up front and keep them cached. If the user loses connectivity, the application will still run. In this respect, the Web app behaves almost identically to a regular app.

### How Do You Use It?

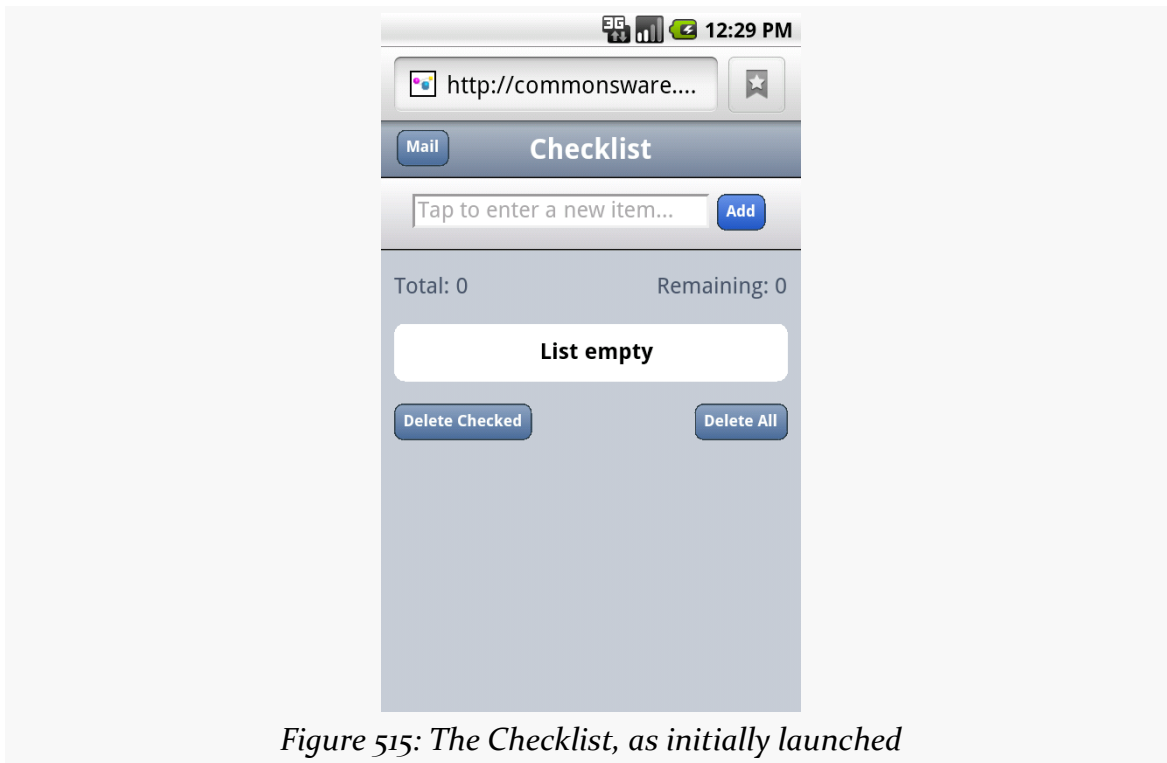
For this chapter, we will use the Checklist “mini app” created by Alex Gibson. While the most up-to-date version of this app can be found at the [MiniApps Web site](#), this chapter will review the copy found in [HTML5/Checklist](#). This copy is also hosted online on the [CommonsWare site](#), or via a shortened URL: <http://bit.ly/cw-html5>.

### About the Sample App

Checklist is, as the name suggests, a simple checklist application. When you first launch it, the list will be empty:

## HTML5

---

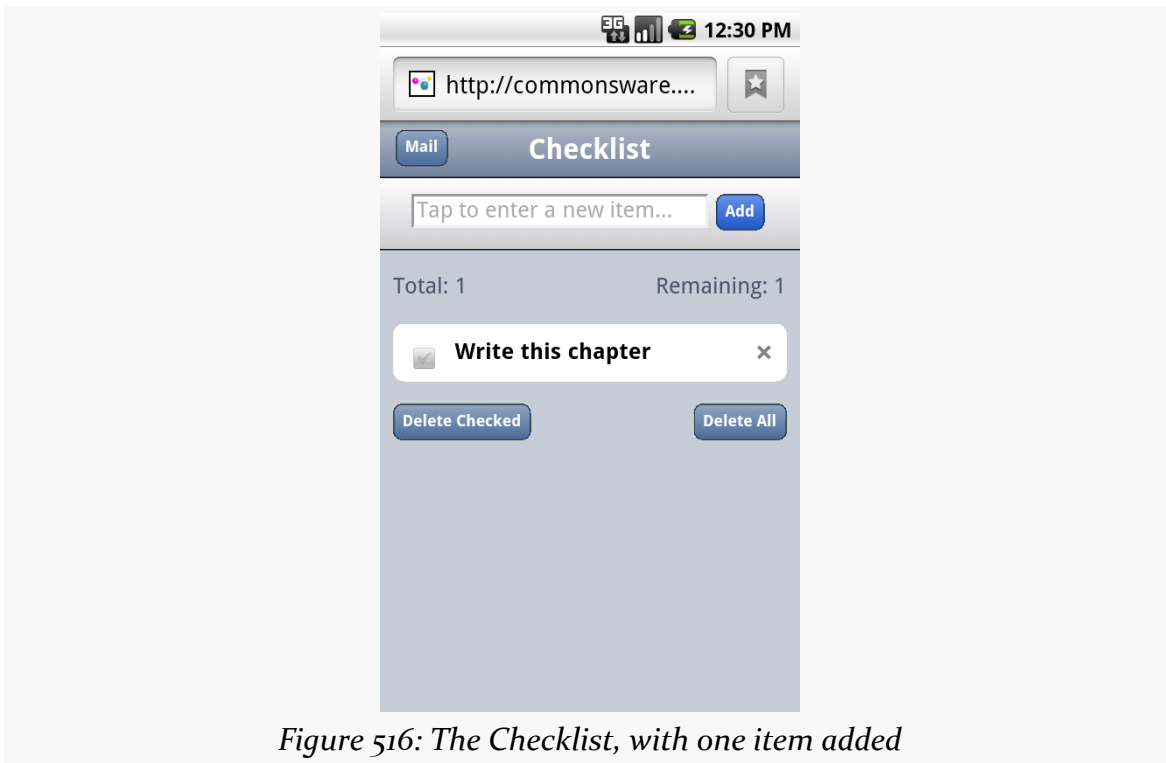


*Figure 515: The Checklist, as initially launched*

You can enter some text in the top field and click the Add button to add it to the list:

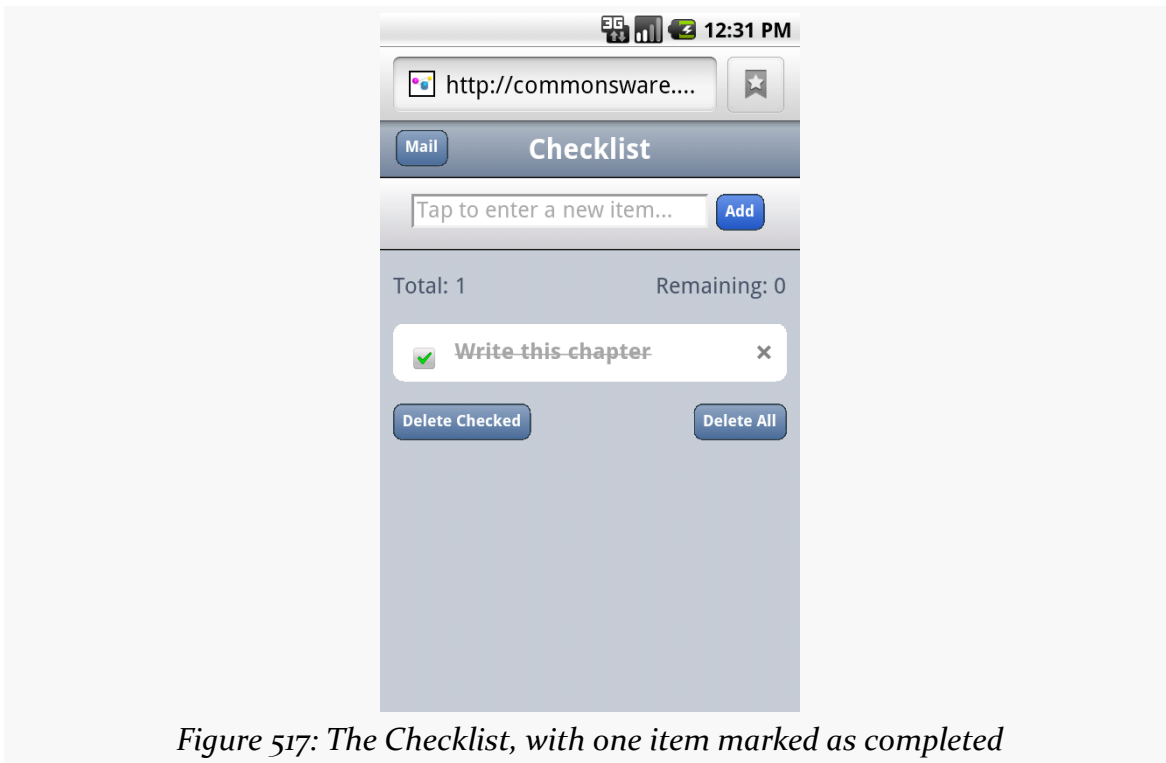
## HTML5

---



*Figure 516: The Checklist, with one item added*

You can “check off” individual items, which are then displayed in strike-through:



*Figure 517: The Checklist, with one item marked as completed*

You can also delete the checked entries (via the Delete Checked button) or all entries (via the Delete All button), which will pop up a confirmation dialog before proceeding:

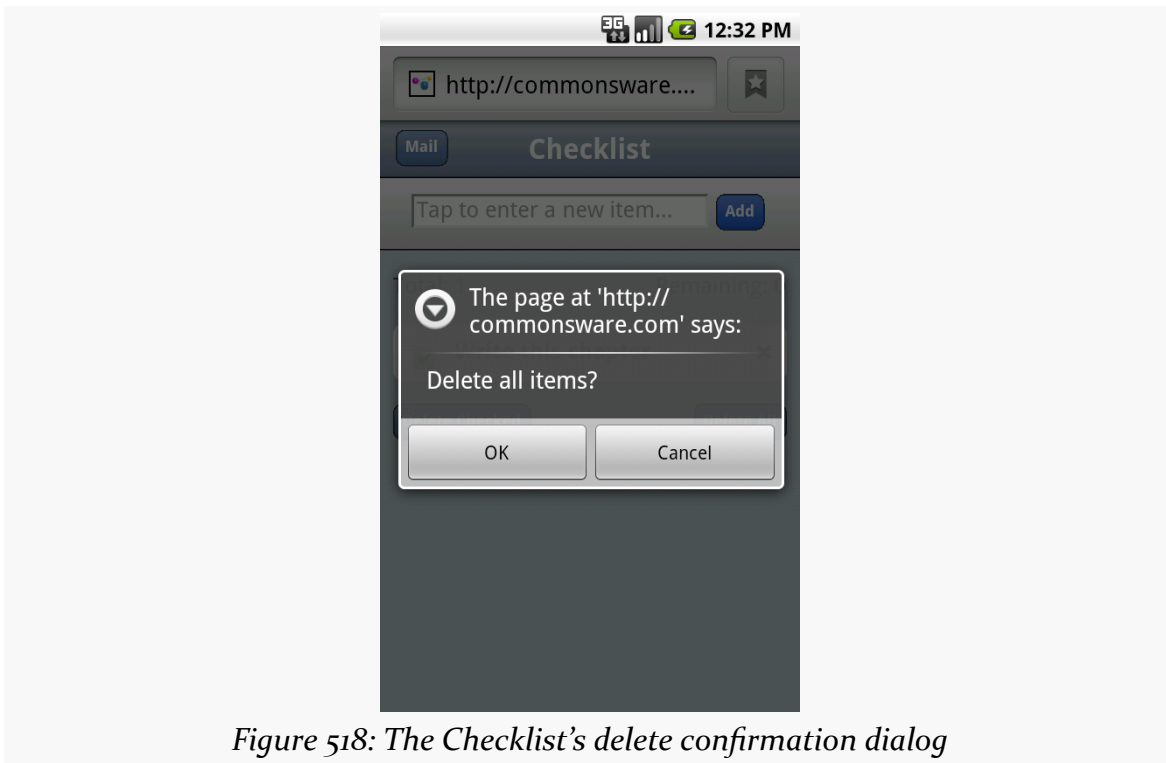


Figure 518: The Checklist's delete confirmation dialog

### “Installing” Checklist on Your Phone

To access Checklist on your Android device, visit one of the URLs above for the hosted edition using the Browser application — the shortened one may be easiest to enter into the browser on the device. You can then add a bookmark for it (More > Add bookmark from the browser's options menu) to come back to it later.

You can even set up a shortcut for the bookmark on your home screen, if you so choose — just long-tap on the background, choose Bookmark, then choose the Checklist bookmark you set up before.

### Examining the HTML

All of that is accomplished using just a handful of lines of HTML:

```
<!DOCTYPE html>
<html lang="en" manifest="checklist.manifest">
<head>
<meta http-equiv="Content-Type" content="text/html; charset=utf-8" />
<title>Checklist</title>
<meta name="viewport"
```

## HTML5

```
    content="width=device-width; initial-scale=1.0; maximum-scale=1.0;
user-scalable=0;" />
<meta name="apple-mobile-web-app-capable" content="yes" />
<meta name="apple-mobile-web-app-status-bar-style" />
<link rel="apple-touch-startup-image" href="splashscreen.png" />
<link rel="stylesheet" href="styles.css" />
<link rel="apple-touch-icon-precomposed"
      href="apple-touch-icon-precomposed.png" />
</head>
<body>
<section>
  <header>
    <button type="button" id="sendmail">Mail</button>
    <h1>Checklist</h1>
  </header>
  <article>
    <form id="inputarea" onsubmit="addNewItem()">
      <input type="text" name="name" id="name" maxlength="75"
        autocorrect placeholder="Tap to enter a new item&hellip;" />
      <button type="button" id="add">Add</button>
    </form>
    <ul id="maillist">
      <li class="empty"><a href="" id="maillink">Mail remaining items</a></li>
    </ul>
    <p id="totals"><span id="tally1">Total: <span id="total">0</span></span>
      <span id="tally2">Remaining: <span id="remaining">0</span></span></p>
    <ul id="checklist">
      <li class="empty">Loading&hellip;</li>
    </ul>
  </article>
  <fieldset>
    <button type="button" id="deletechecked">Delete Checked</button>
    <button type="button" id="deleteall">Delete All</button>
  </fieldset>
</section>
<script src="main.js"></script>
</body>
</html>
```

For the purposes of offline applications, though, the key is the manifest attribute of our html element. Here, we specify the relative path to a manifest file, indicating what the rules are for caching various portions of this application offline.

### Examining the Manifest

So, since the manifest is where all the fun is, here is what Checklist's manifest looks like:

```
CACHE MANIFEST
#version 54
styles.css
```



## HTML5

---

```
main.js  
splashscreen.png
```

The HTML5 manifest format is extremely simple. It starts with a `CACHE MANIFEST` line, followed by a list of files (technically, relative URLs) that should be cached. It also supports comments, which are lines beginning with `#`.

The manifest can also have a `NETWORK:` line, followed by relative URLs that should never be cached. Similarly, the manifest can have a `FALLBACK:` line, followed by pairs of relative URLs: the URL to try to fetch off the network, followed by the URL of a cached resource to use if the network is not available.

In principle, the manifest should request caching for everything that the application needs to run, though the page that requested the caching (`index.html` in this case) is also cached.

## Web Storage

Caching the HTML5 application's assets for offline use is all well and good, but that will be rather limiting on its own. In an offline situation, the application would not be able to use AJAX techniques to interact with a Web service. So, if the application is going to be able to store information, it will need to do so on the browser itself.

Google Gears and related tools pioneered this concept and blazed the trail for what is now variously called "Web Storage" or "DOM Storage" for HTML5 applications. An HTML5 app can store data persistently on the client, within client-imposed limits. That, in conjunction with offline asset caching, means an HTML5 application can deliver far more value when it lacks an Internet connection, or for data that just does not make sense to store "in the cloud".

Note that, technically, Web Storage is not part of HTML5, but is a related specification. However, it tends to get "lumped in with" HTML5 in common conversation.

## What Does It Mean?

On a Web Storage-enabled browser, your JavaScript code will have access to a `localStorage` object, representing your application's data. More accurately, each "origin" (i.e., domain) will have a distinct `localStorage` object on the browser.

The `localStorage` object is an “associative array”, meaning you can work with it either via numerical indexes or string-based keys at your discretion. Values typically are strings. You can:

1. Find out how many entries are in the array via `length()`
2. Get and set items by key via `getItem()` and `setItem()`
3. Get the key for a numerical index via `key()`
4. Remove individual entries via `removeItem()` or remove all items via `clear()`

This means you do not have the full richness of a SQL database, like you might have with SQLite in a native Android application. But, for many applications, this should suffice.

### How Do You Use It?

Checklist stores the list items as keys in the associative array, with a value of 0 for a regular item and 1 for a deleted item. Here, we see the code for putting a new item into the checklist:

```
try {
    localStorage.setItem(strippedString, data);
}
catch (e) {
    if (e == QUOTA_EXCEEDED_ERR) {
        alert('Quota exceeded!');
    }
}
```

Here is the code where those items are pulled back out of storage and put into an array for sorting and, later, display as DOM elements on the Web page itself:

```
/*get all items from localStorage and push them one by one into an
array.*/
for (i = 0; i <= listlength; i++) {
    var item = localStorage.key(i);
    myArray.push(item);
}

/*sort the array into alphabetical order.*/
myArray.sort();
```

When the user checks the checkmark next to an item, the storage is updated to toggle the checked setting persistently:

## HTML5

---

```
/*toggle the check flag.*/
if (target.previousSibling.checked) {
  data = 0;
}
else {
  data = 1;
}
/*save item in localStorage.*/
try {
  localStorage.setItem(name, data);
} catch (e) {

  if (e == QUOTA_EXCEEDED_ERR) {
    alert('Quota exceeded!');
  }
}
}
```

Checklist also has code to delete items from storage, either all those marked as checked:

```
/*remove every item from localStorage that has the data flag checked.*/
while (i <= localStorage.length-1) {

  var key = localStorage.key(i);
  if (localStorage.getItem(key) === '1') {
    localStorage.removeItem(key);
  }
  else { i++; }
}
}
```

... or all items:

```
/*deletes all items in the list.*/
deleteAll: function() {

  /*ask for user confirmation.*/
  var answer = confirm("Delete all items?");

  /*if yes.*/
  if (answer) {

    /*remove all items from localStorage.*/
    localStorage.clear();
    /*update view.*/
    checklistApp.getAllItems();
  }
  /*clear up.*/
  delete checklistApp.deleteAll;
},
```

### Web SQL Database

Android's built-in browser also supports a “Web SQL Database” option, one where you can use SQLite-style databases from JavaScript. This adds a lot more power than basic Web Storage, albeit at a complexity cost. It is also not part of an active standard — the [WHATWG team](#) working on this standard has set it aside for the time being.

You might consider evaluating [Lawnchair](#), which is a JavaScript API that allows you to store arbitrary JSON-encoded objects. It will use whatever storage options are available, and therefore will help you deal with cross-platform variety. In particular, it supports the Google Gears facility found in some older versions of Android.

### Going To Production

Creating a little test application requires nothing magical. Presumably, though, you are interested in others using your application – perhaps many others. Classic Java-based Android applications have to deal with testing, having the application digitally signed for production, distribution through various channels (such as the Android Market), and updates to the application by one means or another. Those issues do not all magically vanish because HTML5 is used as the application environment. However, HTML5 does change things significantly from what Java developers have to do.

### Testing

Since HTML5 works in other browsers, testing your business logic could easily take advantage of any number of HTML and JavaScript testing tools, from [Selenium](#) to [JUnit](#) to [Jasmine](#).

For testing on Android proper — to ensure there are no issues related to Android's browser implementation — you can use Selenium's [Android Driver](#) or [Remote Control](#) modes.

### Signing and Distribution

Unlike native Android applications, you do not need to worry about signing your HTML5 applications.

## HTML5

---

The downside of this is that there is no support for distribution of HTML5 applications through the Play Store, which today only supports native Android apps. Users will have to find your application by one means or another, visit it in the browser, bookmark the page, and possibly create a home screen shortcut to that bookmark.

### Updates

Unlike native Android applications, which by default must be updated manually, HTML5 applications will be transparently updated the next time they run the app while connected to the Internet. The offline caching protocol will check the Web server for new editions of files before falling back to the cached copies. Hence, there is nothing more for you to do other than publish the latest Web app assets.

### Issues You May Encounter

Unfortunately, nothing is perfect. While HTML5 may make many things easier, it is not a panacea for all Android development problems.

This section covers some potential areas of concern you will want to consider as you move forward with HTML5 applications for Android.

#### Android Device Versions

Not all Android devices support HTML5 — only those running Android 2.x or higher. Ideally, therefore, you do a bit of “user-agent sniffing” on your Web server and redirect older Android users to some other page explaining the limitations in their device.

Here is the user-agent string for a Nexus One device running Android 2.1:

```
Mozilla/5.0 (Linux; U; Android 2.1-update1; en-us; Nexus One  
Build/ERE27) AppleWebKit/530.17 (KHTML, like Gecko) Version/4.0 Mobile  
Safari/530.17
```

As you can see, it is formatted like a typical modern user-agent string, meaning it is quite a mess. It does indicate it is running Android 2.1-update1.

Eventually, somebody will create a database of user-agent strings for different device models, and from there we can derive appropriate regular expressions or similar algorithms to determine whether a given device can support HTML5 applications.

### Screen Sizes and Densities

HTML5 applications can be run on a wide range of screen sizes, from QVGA Android devices to 1080p LCDs and beyond. Similarly, screen densities may vary quite a bit, so while a 48x48 pixel image on a smartphone may be an appropriate size, it may be too big for a 1080p television, let alone a 24" LCD desktop monitor.

Other than increasing the possible options on the low end of screen sizes, none of this is unique to Android. You will need to determine how best to design your HTML and CSS to work on a range of sizes and densities, even if Android were not part of the picture.

### Limited Platform Integration

HTML5, while offering more platform integration than ever before, does not come close to covering everything an Android application might want to be able to do. For example, an ordinary HTML5 application cannot:

1. Launch another application
2. Work with the contacts database
3. Raise a notification
4. Do work truly in the background (though “Web workers” may alleviate this somewhat someday)
5. Interact with Bluetooth devices
6. Record audio or video
7. Use the standard Android preference system
8. Use speech recognition or text-to-speech
9. And so on

Many applications will not need these capabilities, of course. And, one can expect that other application environments, like [PhoneGap](#), will evolve into “HTML5 Plus” for Android. That way, you could create a stock application that works across all devices and an enhanced Android application that leverages greater platform integration, at the cost of some additional amount of programming.

### Performance and Battery

There has been a nagging concern for some time that HTML-based user interfaces are inefficient compared to native Android UIs, in terms of processor time, memory,

and battery. For example, one of the stated reasons for avoiding [BONDI](#)-style Web widgets for the Android home screen is performance.

Certainly, it is possible to design HTML5 applications that will suck down the battery. For example, if you have a hunk of JavaScript code running every second indefinitely, that is going to consume a fair amount of processor time. However, outside of that, it seems unlikely that an ordinary application would be used so heavily as to materially impact battery life. Certainly, more testing will need to be done in this area.

Also, an HTML5 application may be a bit slower to start up than are other applications, if the Browser has not been used in a while, or if the network connection is there but has minimal bandwidth to your server.

### **Look and Feel**

HTML5 applications can certainly look very slick and professional – after all, they are built with Web technologies, and Web apps can look very slick and professional.

However, HTML5 applications will not necessarily look like standard Android applications, at least not initially. Some enterprising developers will, no doubt, create some reusable CSS, JavaScript, and images that will, for example, mirror an Android native Spinner widget (a type of drop-down control). Similarly, HTML5 applications will tend to lack options menus, notifications, or other UI features that a native Android application may well use.

This is not necessarily bad. Considering the difficulty in creating a very slick-looking Android application, HTML5 applications may tend to look better than their Android counterparts. After all, there are many more people skilled in creating slick Web apps than are skilled in creating slick Android apps.

However, some users may complain about the look-and-feel disparity, just because it is different.

### **Distribution**

HTML5 applications can be trivially added to a user's device — browse, bookmark, and add a shortcut to the home screen.

## HTML5

---

However, HTML5 applications will not show up in the Play Store, so users trained to look at the Market for available applications will not find HTML5 applications, even ones that may be better than their native counterparts.

It is conceivable that, someday, the Play Store will support HTML5 applications. It is also conceivable that, someday, Android users will tend to find their apps by means other than searching the Android Market, and will be able to get their HTML5 apps that way. However, until one of those becomes true, HTML5 applications may be less “discoverable” than their native equivalents.

### HTML5: The Baseline

HTML5 is likely to become rather popular for conventional application development. It gives Web developers a route to the desktop. It may be the only option for Google’s Chrome OS. And, with ever-improving support on popular mobile devices — Android among them — developers will certainly be enticed by another round of “write once, run anywhere” promises.

It is fairly likely that, over time, HTML5 will be the #2 option for Android application development, after the conventional Java application written to the Android SDK. That will make HTML5 the baseline for comparing alternative Android development options — not only will those options be compared to using the SDK, they will be compared to using HTML5.





# PhoneGap

---

PhoneGap is perhaps the original alternative application framework for Android, arriving on the scene in early 2009. PhoneGap is open source, backed by Adobe, who in 2011 acquired Nitobi, the firm founded by PhoneGap's creators.

## Prerequisites

Understanding this chapter requires that you have read the [chapter on WebView](#) and the [chapter on HTML5](#).

## What Is PhoneGap?

As the [PhoneGap About page](#) puts it:

Mobile development is a mess. Building applications for each device — iOS, Android, Windows Phone and more — requires different frameworks and languages. One day, the big players in mobile may decide to work together and unify third-party app development processes. Until then, PhoneGap will use standards-based web technologies to bridge web applications and mobile devices. Plus, because PhoneGap apps are standards compliant, they're future-proofed to work with browsers as they evolve.

PhoneGap, today, focuses on bridging the gap between Web technologies and native mobile development, with access to more features than [HTML5 applications](#) have.

## What Do You Write In?

A PhoneGap application is made up of HTML, CSS, and JavaScript, no different than a mobile Web site or HTML5 application, except that the Web assets are packaged with the application, rather than downloaded on the fly.

A pre-installed PhoneGap application, therefore, can contain comparatively large assets, such as complex JavaScript libraries, that might be too slow to download over slower EDGE connections. However, PhoneGap will still be limited by the speed of mobile devices and how quickly WebKit can load and process those assets.

Also, development for WebKit-for-mobile has its differences over development for WebKit-for-desktops, particularly with respect to touch versus mouse events. You may want to develop using mobile layers of JavaScript frameworks (e.g., [jqTouch](#) versus plain [jQuery](#)) where practical.

## What Features Do You Get?

As with an HTML5 application, you get the basic capabilities of a Web browser, including AJAX support. Beyond that, PhoneGap adds a number of JavaScript APIs to allow you to get at the underlying features of the Android platform. At the time of this writing, that includes:

1. Accelerometer access, for detecting movement of the device
2. Audio recording
3. Camera access, for taking still pictures
4. Database access, both to databases of your creation (SQLite) or others built into Android (e.g., contacts)
5. File system access, such as to the SD card or other external storage
6. Geolocation, for determining where the device is
7. Vibration, for shaking the phone (e.g., force-feedback)

Since some of these are part of the HTML5 specification (e.g., geolocation), you have your choice of APIs. Also, this list changes over time, so you may have access to more than what is described here.

## What Do Apps Look Like?

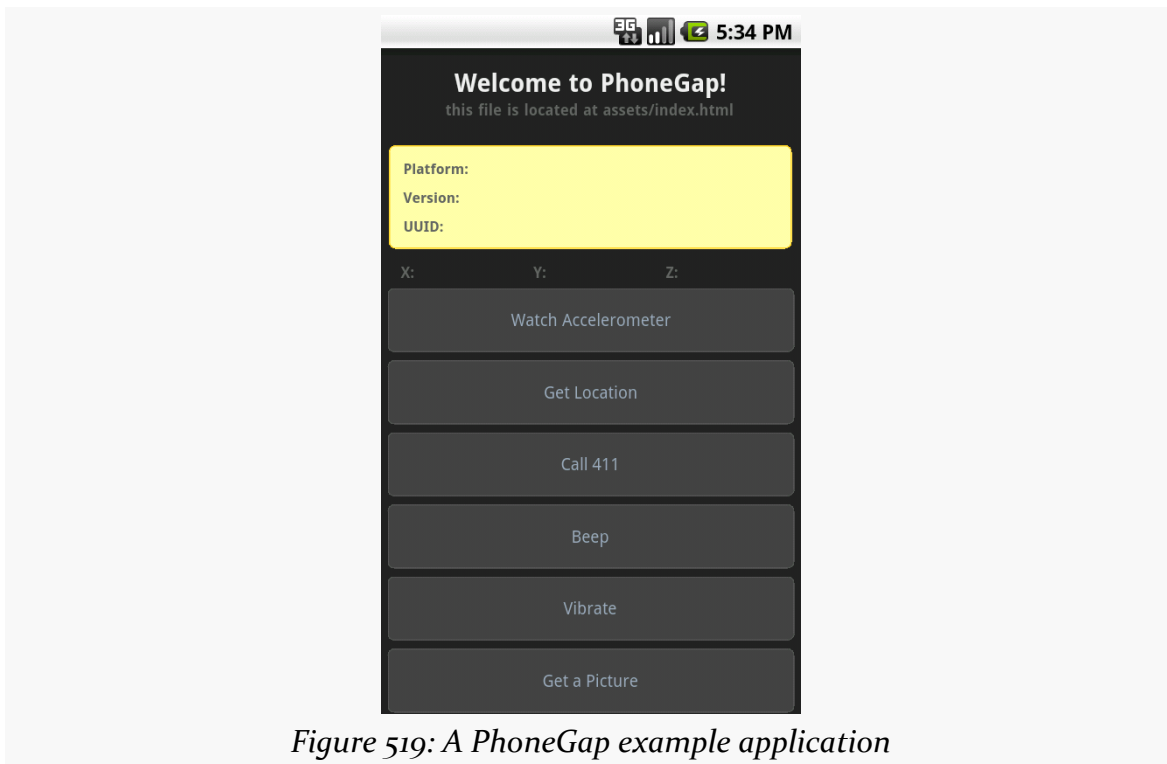
They will look like Web pages, more so than native Android apps. You can use CSS and images to mimic the Android look and feel to some extent, but only for those

## PHONEGAP

---

sorts of widgets that are readily able to be created in both Android and HTML. For example, the Android Spinner widget — which resembles a drop-down list — may be difficult to mimic in HTML.

Here is a screenshot of a PhoneGap example application:



*Figure 519: A PhoneGap example application*

### How Does Distribution Work?

Distributing a PhoneGap application is pretty much identical to distributing any other standard Android application. After testing, you will create a standard APK file with the Android build tools, from an Android project generated for you by PhoneGap. This project will contain the Java, XML, and other necessary bits to wrap around your HTML, CSS, and JavaScript to make up your application. Then, you digitally sign the application and upload it to the Play Store or any other distribution mechanism you wish to use.

### What About Other Platforms?

PhoneGap is not just for Android. You can create PhoneGap applications for iOS, Blackberry, some flavors of Symbian, and more. In theory, at least, you can create

one application using HTML, CSS, JavaScript, and the PhoneGap JavaScript APIs, and have it run across many devices.

There are a couple of limitations that will hamper your progress to that goal:

- The Web browsing component used by PhoneGap across all those platforms is not identical. Even multiple platforms using WebKit will have different WebKit releases, based upon what was available when WebKit was integrated into a given device's firmware. Hence, you will want to test and ensure your CSS, in particular, works as you would expect on as many devices as possible.
- Not all PhoneGap JavaScript APIs are available on all devices as yet, due to a variety of factors (e.g., not exposed in the platform's native APIs, lack of engineering time to hoist the capability into the PhoneGap APIs). There is a [table on the PhoneGap site](#) that will keep you apprised of what works and what does not across the devices. You will want to restrict your feature use to match your desired platforms, or restrict your platforms to match your desired features.

### How Is It Licensed?

PhoneGap is available under the Apache Software License 2.0. In 2011, Nitobi contributed PhoneGap to the Apache Software Foundation (ASF) for independent management, just prior to being acquired by Adobe. This has now turned into [Apache Cordova](#).

### Using PhoneGap

Now, let's look at more of the mechanics for using PhoneGap.

PhoneGap's installation and usage, as of the time of this writing, normally requires an expert in Java-based Android development. You need to install a whole bunch of tools, edit configuration files by hand, and so forth. If you want to do all of that, documentation is available on the PhoneGap site.

If you are reading this chapter, there's a decent chance that you would rather skip all of that. Hence, for many, the best answer is the [PhoneGap/Build](#) service.

### Installation

The PhoneGap Web site will allow you to download the latest PhoneGap tools as a ZIP archive. You can unpack those wherever it makes sense for your development machine and platform.

For Android development, that is all of the PhoneGap-specific installation you will need. However, you will need the Android SDK and related tools (e.g., Eclipse, if you wish to use Eclipse) for setting up the project.

### Creating and Installing Your Project

A PhoneGap Android project is, at its core, a regular Android project, which you can create following the instructions outlined [earlier in this book](#). To convert the standard generated “Hello, World” application into a PhoneGap project, you need to do the following:

- From the `Android/` directory of wherever you unZIPped the PhoneGap ZIP file, copy the PhoneGap JAR file to the `libs/` directory of your project. If you are using Eclipse, you will also need to add it to your build path.
- Create an `assets/www/` directory in your project. Then, copy over the PhoneGap JS file from the `Android/` directory of wherever you unZIPped the PhoneGap ZIP file.
- Adjust the standard “Hello, World” activity to inherit from `DroidGap` instead of `Activity`. This will require you to import `com.phonegap.DroidGap`.
- In your activity’s `onCreate()` method, replace `setContentView()` with `super.loadUrl("file:///android_asset/www/index.html");`
- In your manifest, add all of the permissions that PhoneGap requests, listed [later in this chapter](#).
- Also in your manifest, add a suitable `<supports-screens>` element based upon what screen sizes you are willing to test and support.
- Also in your manifest, add `android:configChanges="orientation|keyboardHidden"` to your `<activity>` element, as `DroidGap` handles orientation-related configuration changes

At this point, you can create an `assets/www/index.html` file in your project and start creating your PhoneGap application using HTML, CSS, and JavaScript. You will need to have a reference to the PhoneGap JavaScript file (e.g., `<script type="text/javascript" charset="utf-8"`

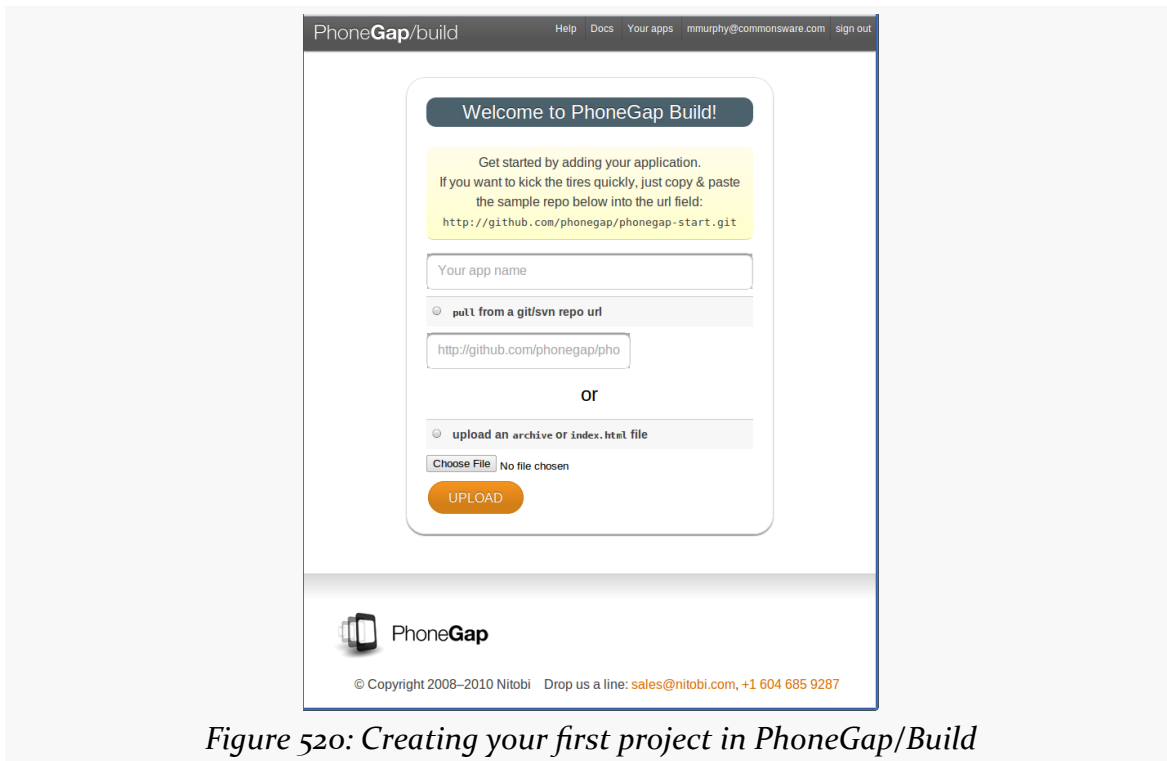
`src="phonegap.0.9.4.js" />). When you want to test the application, you can build and install it like any other Android application (e.g., ant clean debug install if you are using the command line build process).`

For somebody experienced in Android SDK development, setting this up is not a big challenge.

### PhoneGap/Build

PhoneGap/Build is a Tools-as-a-Service (TaaS) hosted approach to creating PhoneGap projects. This way, all of the Android build process is handled for you by PhoneGap-supplied servers. You just focus on creating your HTML, CSS, and JavaScript as you see fit.

When you log into PhoneGap/Build, you are first prompted to create your initial project, by supplying a name and the Web assets to go into the app:



You will be able to add new projects later on via a New App button, which gives you the same set of options.

## PHONEGAP

---

Your choices for the assets are to upload a ZIP file containing all of them, or to specify the URL to a public GitHub repository that PhoneGap/Build can pull from. The latter tends to be more convenient, if you are used to using Git for version control, and if your project is open source (and therefore has a public repository).

Once you click the Upload button, the PhoneGap/Build server will immediately start building your application for Android, plus Blackberry, Symbian, and WebOS:



*Figure 521: Building your first project in PhoneGap/Build*

Each of the targets has its own file extension (e.g., apk for Android). Clicking that link will let you download that file. Or, click on the name of the project, and you get QR codes to enable downloads straight to your test device:



# PHONEGAP

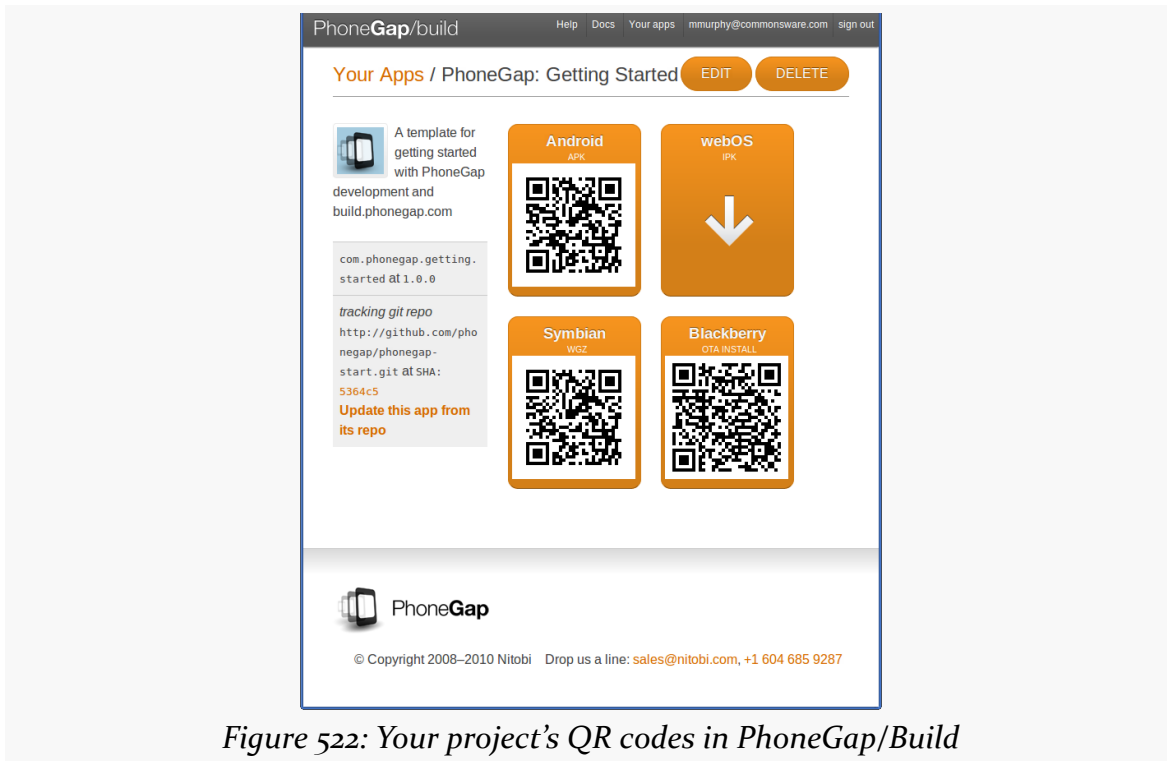


Figure 522: Your project's QR codes in PhoneGap/Build

This page also gives you a link to update the app from its GitHub repo (if you chose that option). Or, click Edit to specify more options, such as the version of your application or its launcher icon:

## PHONEGAP

---

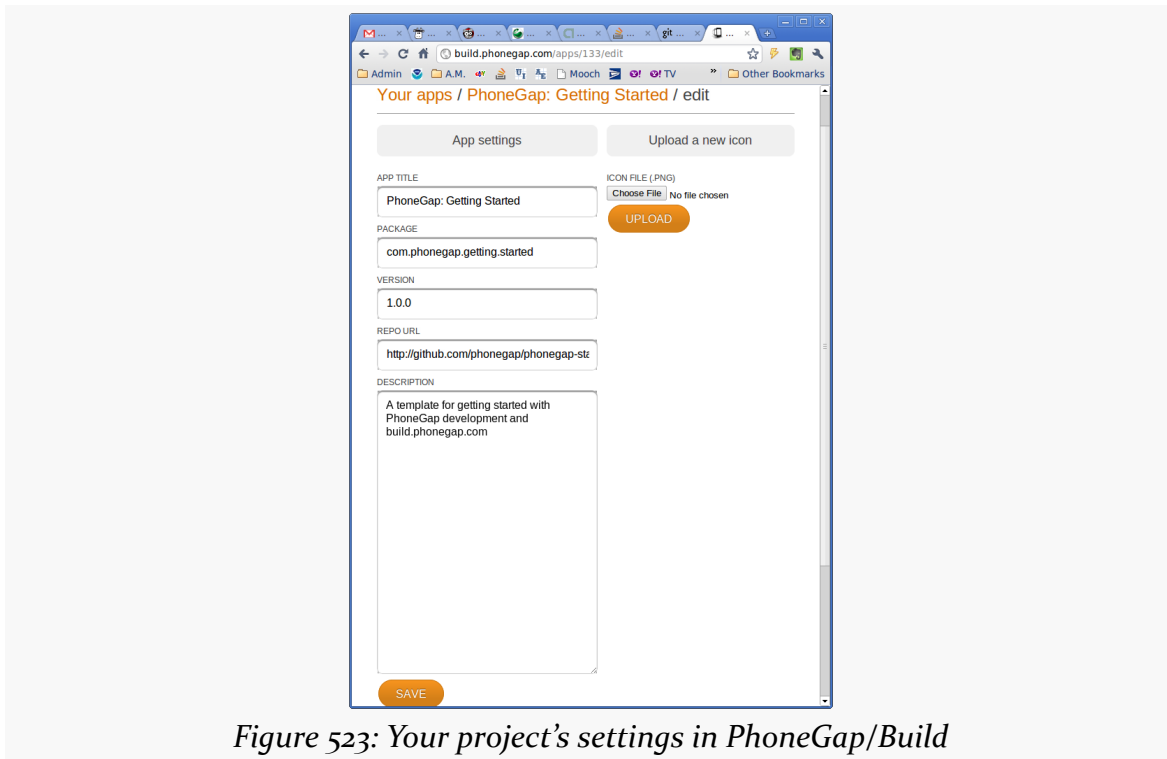


Figure 523: Your project's settings in PhoneGap/Build

All in all, if you do not otherwise need the Android SDK and related tools on your development machine, PhoneGap/Build certainly simplifies the PhoneGap building process.

PhoneGap/Build is free for open source (public) projects, but there are fees associated with private use beyond a single app.

## PhoneGap and the Checklist Sample

The beauty of PhoneGap is that it wraps around HTML, CSS, and JavaScript. In other words, you do not have to do much of anything PhoneGap-specific to be able to take advantage of PhoneGap delivering to you an APK suitable for installation on an Android device. That being said, PhoneGap does expose more stuff to you than you can get from the standards, if you need them and are willing to use proprietary PhoneGap APIs for them.

### Sticking to the Standards

Given an existing HTML5 application, all you need to do to make it be an installable APK is wrap it in PhoneGap.

For example, to convert the HTML5 version of Checklist into an APK file, you need to:

- Follow the steps to create an empty PhoneGap project outlined [earlier in this chapter](#)
- Copy the HTML, CSS, JavaScript, and images from the HTML5 project into the `assets/www/` directory of the PhoneGap project (note that you do not need things unique to HTML5, such as the cache manifest)
- Make sure that your HTML entry point filename matches the path you used with the `loadUrl()` call in your activity (e.g., `index.html`)
- Add a reference to the PhoneGap JavaScript file from your HTML
- Build and install the project

Here is the DroidGap activity for our app, from the PhoneGap/Checklist project:

```
package com.commonware.pg.checklist;

import android.app.Activity;
import android.os.Bundle;
import com.phonegap.DroidGap;

public class Checklist extends DroidGap {
    @Override
    public void onCreate(Bundle savedInstanceState) {
        super.onCreate(savedInstanceState);
        super.loadUrl("file:///android_asset/www/index.html");
    }
}
```

Here is the manifest, with all of the PhoneGap-requested settings added:

```
<?xml version="1.0" encoding="utf-8"?>
<manifest android:versionCode="1"
    android:versionName="1.0"
    package="com.commonware.pg.checklist"
    xmlns:android="http://schemas.android.com/apk/res/android">

    <application android:icon="@drawable/cw"
        android:label="@string/app_name">
        <activity android:configChanges="orientation|keyboardHidden"
            android:label="@string/app_name"
            android:name="Checklist">
```

## PHONEGAP

---

```
<intent-filter>
  <action android:name="android.intent.action.MAIN" />
  <category android:name="android.intent.category.LAUNCHER" />
</intent-filter>
</activity>
</application>
<supports-screens android:anyDensity="true"
  android:largeScreens="true"
  android:normalScreens="true"
  android:resizeable="true"
  android:smallScreens="true" />
<uses-permission android:name="android.permission.CAMERA" />
<uses-permission android:name="android.permission.VIBRATE" />
<uses-permission android:name="android.permission.ACCESS_COARSE_LOCATION" />
<uses-permission android:name="android.permission.ACCESS_FINE_LOCATION" />
<uses-permission
android:name="android.permission.ACCESS_LOCATION_EXTRA_COMMANDS" />
<uses-permission android:name="android.permission.READ_PHONE_STATE" />
<uses-permission android:name="android.permission.INTERNET" />
<uses-permission android:name="android.permission.RECEIVE_SMS" />
<uses-permission android:name="android.permission.RECORD_AUDIO" />
<uses-permission android:name="android.permission.MODIFY_AUDIO_SETTINGS" />
<uses-permission android:name="android.permission.READ_CONTACTS" />
<uses-permission android:name="android.permission.WRITE_CONTACTS" />
<uses-permission android:name="android.permission.WRITE_EXTERNAL_STORAGE" />
<uses-permission android:name="android.permission.ACCESS_NETWORK_STATE" />
</manifest>
```

And here is the HTML — almost identical to the HTML5 original, removing some HTML5 offline stuff (e.g., iOS icons) and adding in the reference to PhoneGap's JavaScript file:

```
<!DOCTYPE html>
<html lang="en" manifest="checklist.manifest">
<head>
  <meta http-equiv="Content-Type" content="text/html; charset=utf-8" />
  <title>Checklist</title>
  <meta name="viewport"
    content="width=device-width; initial-scale=1.0; maximum-scale=1.0;
user-scalable=0;" />
  <link rel="stylesheet" href="styles.css" />
  <script type="text/javascript" charset="utf-8"
src="phonegap.0.9.4.js"></script>
</head>
<body>
  <section>
    <header>
      <button type="button" id="sendmail">Mail</button>
      <h1>Checklist</h1>
    </header>
    <article>
      <form id="inputarea" onsubmit="addNewItem()">
        <input type="text" name="name" id="name" maxLength="75"
```

```
                                autocorrect placeholder="Tap to enter a new item&hellip;";"
/>
    <button type="button" id="add">Add</button>
  </form>
  <ul id="maillist">
    <li class="empty"><a href="" id="maillink">Mail remaining
items</a></li>
  </ul>
  <p id="totals"><span id="tally1">Total: <span
id="total">0</span></span>
  <span id="tally2">Remaining: <span
id="remaining">0</span></span></p>
  <ul id="checklist">
    <li class="empty">Loading&hellip;</li>
  </ul>
</article>
<fieldset>
  <button type="button" id="deletechecked">Delete Checked</button>
  <button type="button" id="deleteall">Delete All</button>
</fieldset>
</section>
<script src="main.js"></script>
</body>
</html>
```

For many applications, this is all you will need — you are simply looking at PhoneGap to give you something you can distribute on the Play Store, on the iOS App Store, and so on.

## Adding PhoneGap APIs

If you want to take advantage of more device capabilities, you can augment your HTML5 application to use PhoneGap-specific APIs. These run the gamut from telling you the device's model to letting you get compass readings. Hence, their complexity will vary. For the purposes of this chapter, we will look at some of the simpler ones.

### Set up Device-Ready Event Handler

For various reasons, PhoneGap will not be ready to respond to all of its APIs right away when your page is loaded. Instead, there is a `deviceready` event that you will need to watch for in order to know when it is safe to use PhoneGap-specific JavaScript globals. The typical recipe is:

- Add an `onload` attribute to your `<body>` tag, referencing a global JavaScript function (e.g., `onLoad()`)

## PHONEGAP

---

- In `onLoad()`, use `addEventListener()` to register another global JavaScript function (e.g., `onDeviceReady()`) for the `deviceready` event
- In `onDeviceReady()`, start using the PhoneGap APIs

### Use What PhoneGap Gives You

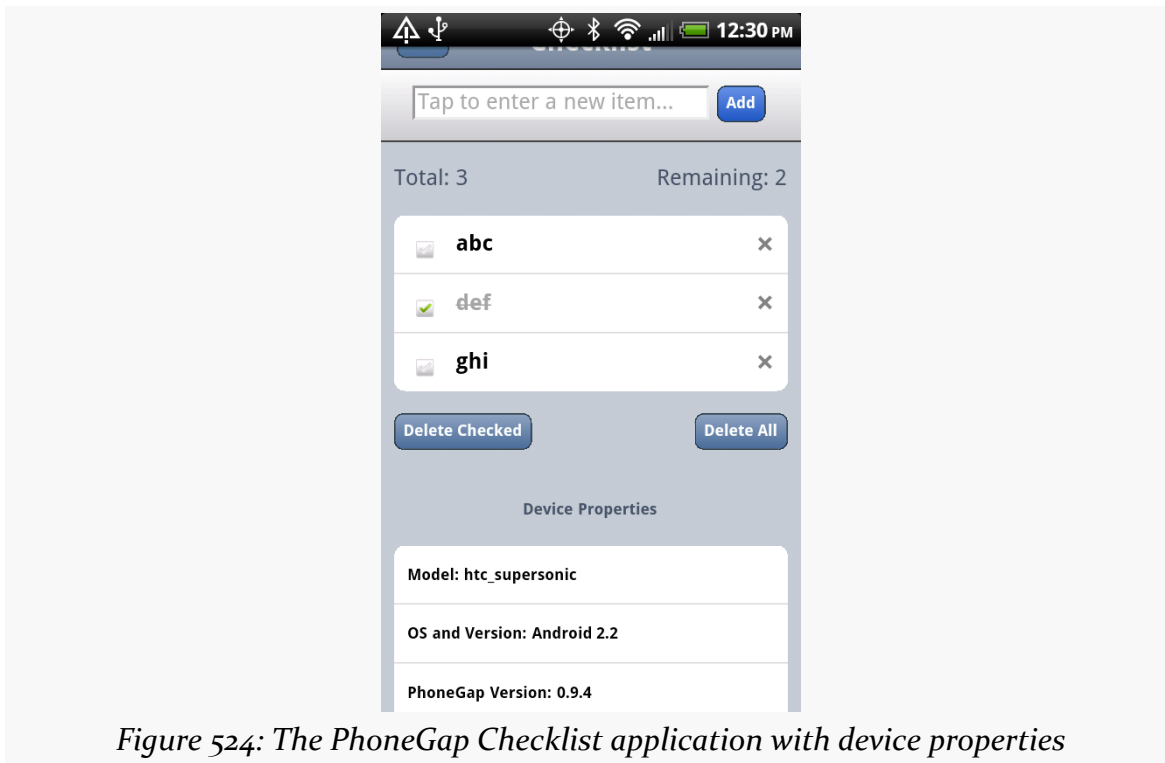
PhoneGap makes a number of methods available to you through a series of virtual JavaScript objects. Here, “virtual” means that you cannot check to see if the objects exist, but you can call methods and read properties on them. So, for example, there is a `device` object that has a handful of useful properties, such as `phonegap` to return the PhoneGap version and `version` to return the OS version. These virtual objects are ready for use in or after the `deviceready` event.

For example, here is a JavaScript file (`props.js` from the PhoneGap/ChecklistEx project) that implements an `onLoad()` function (to register for `deviceready`) and an `onDeviceReady()` function (to use the `device` object’s properties):

```
// PhoneGap's APIs are not immediately ready, so set up an  
// event handler to find out when they are ready  
  
function onLoad() {  
    document.addEventListener("deviceready", onDeviceReady, false);  
}  
  
// Now PhoneGap's APIs are ready  
  
function onDeviceReady() {  
    var element=document.getElementById('props');  
  
    element.innerHTML='<li>Model: '+device.name+'</li>' +  
                    '<li>OS and Version: '+device.platform +  
'+device.version+'</li>' +  
                    '<li>PhoneGap Version: '+device.phonegap+'</li>';  
}
```

The `onDeviceReady()` function needs a list element with an id of `props`.

The resulting app looks like:



*Figure 524: The PhoneGap Checklist application with device properties*

Obviously, reading a handful of properties is far simpler than, say, taking a picture with the device's camera. However, the difference in complexity is mostly in what PhoneGap's virtual JavaScript objects give you and how you can use them, more so than anything peculiar to Android.

## Issues You May Encounter

PhoneGap is a fine choice for creating cross-platform applications. However, it is not without its issues. Some of these issues may be resolved in time; some may be endemic to the nature of PhoneGap.

### Security

Android applications use a permission system to request access to certain system features, such as making Internet requests or reading the user's contacts. Applications must request these permissions at install time, so the user can elect to abandon the installation if the requested permissions seem suspect.

A general rule of thumb is that you should request as few permissions as possible, and make sure that you can justify why you are requesting the remaining permissions.

PhoneGap, for a new project, requests quite a few permissions:

1. CAMERA
2. VIBRATE
3. ACCESS\_COARSE\_LOCATION
4. ACCESS\_FINE\_LOCATION
5. ACCESS\_LOCATION\_EXTRA\_COMMANDS
6. READ\_PHONE\_STATE
7. INTERNET
8. RECEIVE\_SMS
9. RECORD\_AUDIO
10. MODIFY\_AUDIO\_SETTINGS
11. READ\_CONTACTS
12. WRITE\_CONTACTS
13. WRITE\_EXTERNAL\_STORAGE
14. ACCESS\_NETWORK\_STATE

Leaving this roster intact will give you an application that can use every API PhoneGap makes available to your JavaScript... and an application that will scare away many users. After all, it is unlikely that your application will be able to use, let alone justify, all of these permissions.

It is certainly possible for you to trim down this list, by modifying the `AndroidManifest.xml` file in the root of your PhoneGap project. However, you will then need to thoroughly test your application to make sure you did not get rid of a permission that you actually need. Also, it may be unclear to you which permissions you can safely remove.

Eventually, the PhoneGap project may have tools to help guide you in the choice of permissions, perhaps by statically analyzing your JavaScript code to see which PhoneGap APIs you are using. In the meantime, though, getting the proper set of permissions will involve a lot of trial and error.

### Screen Sizes and Densities

Normal Web applications primarily focus on screen resolution and window sizes as their primary variables. However, mobile Web applications will not have to worry



about window sizes, as browsers and apps typically run full-screen. Mobile Web applications will need to deal with physical size and density, though — issues that are “off the radar” for traditional Web development.

Netbooks can have screens that are 10” or smaller. Desktops can have screens that are 24” or larger. On the surface, therefore, physical screen size would seem to be something Web developers would need to address. However, generally, screen resolution (in pixels) tracks well with physical size in the netbook/notebook/desktop realm. That is because screen density is fairly consistent across their LCDs, and that density is fairly low.

Smartphones, on the other hand, have several different densities, causing the connection between resolution and size to be broken. Some low-end phones, particularly with small (e.g., 3”) LCDs, have densities on par with nice monitors. Mid-range phones have twice the density (240dpi versus 120dpi). Apple’s iPhone 4 has even higher density, and there are some Android devices with similar densities. Hence, an 800x480 resolution could be on a screen ranging anywhere from 4” to 7”, for example. Tablets add even more possible sizes to the mix.

This is compounded by the problems caused by touchscreens. A mouse can get pixel-level precision in its clicks. Fingers are much less precise. Hence, you tend to need to make your buttons and such that much bigger on a touchscreen, so it can be “finger-friendly”.

This causes some problems with scaling of assets, particularly images. What might be “finger-friendly” on a low-density 3” device might be entirely too small for a high-density 4” device.

Native Android applications have built-in logic for dealing with this issue, in the form of multiple sets of “resources” (e.g., images) that can be swapped in based upon device characteristics. Eventually, PhoneGap and similar tools will need to provide relevant advice for their users for how to create applications that can similarly adapt to circumstances.

### **Look and Feel**

A Web app never quite looks like a native one. This is not necessarily a bad thing. However, some users may find it disconcerting, particularly since they will not understand why their newly-installed app (made with PhoneGap, for example) would necessarily look substantially different than any other similar app they may already have.

As HTML5 applications become more prominent on Android, this issue should decline in importance. However, it is something to keep in mind for the next year or two.

### For More Information

At the moment, the best information on PhoneGap can be found on [the PhoneGap site](#), including their API documentation.



# Other Alternative Environments

---

The alternative application environments described in the preceding chapters are but the tip of the iceberg. Here, we will take a look at a few other alternative application environments, from the growing flood of such technologies.

Note that this area changes rapidly, and so the material in this chapter may be somewhat out of date relative to the progress each of these technologies has made.

## Prerequisites

Understanding this chapter requires that you have read the core chapters and understand how Android apps are set up and operate. Reading the [introduction to this trail](#) might not be a bad idea.

## Rhodes

Spiritually, Rhodes is similar to [PhoneGap](#), in that you develop an Android application whose user interface is defined via HTML, CSS, and JavaScript. The difference is that Rhodes bakes in a full Ruby environment, with a Rails-esque framework. Your Ruby code generates HTML and such to be “served” to an activity via a WebView widget, much like a server-side Ruby Web app would generate HTML to be served to a standalone Web browser.

Similar to PhoneGap, you can either build the project on your development machine or use their hosted build process. The latter is recommended, partly because the requirements for local builds are higher than those for PhoneGap — notably, Rhodes requires the Native Development Kit (NDK) for building and linking the Ruby interpreter to your application.

Rhodes winds up creating larger applications than does PhoneGap, due to the overhead of the Ruby interpreter (~1.5MB). However, if you are used to server-side Web development, Rhodes may be easier for you to pick up than would PhoneGap.

## Flash, Flex, and AIR

Adobe has been hard at work extending their Flash, Flex, and AIR technologies to the mobile space. You can use Flex (the “Hero” edition) and Flash Builder (the “Burrito” edition... raising the question of whether the “hero” is hungry) to create Android APK files that can be distributed on the Play Store and deployed to Android devices. Those devices will need to have the AIR runtime installed — this is free, but a large download, and it only works on Android 2.2+ devices. The same projects can be repackaged for iOS and the Blackberry Playbook tablet, and possibly future devices down the road.

AIR does not have quite as tight of integration to the platform as does PhoneGap (e.g., no access to the device’s contacts), though one imagines that this is an area on which Adobe will devote more resources over time. And, Adobe is a large firm, with a large ecosystem behind it and many existing Flash, Flex, and AIR developer resources to tap into.

Note, though, that Adobe is officially discontinuing the Flash plug-in for Android after the Android 4.0 (Ice Cream Sandwich) release, which casts some doubt as to their long-term plans in the Flash/AIR space on mobile.

## JRuby and Ruboto

One of the most popular languages designed to run on the JVM — besides Java itself — is JRuby. JRuby was quickly ported to run on Android, but with some optimizations disabled, since JRuby is really running on the Dalvik virtual machine that underlies the Android environment, not a classic Java VM.

However, JRuby alone cannot create Android applications. As a scripting language, there is no way for it to define an activity or other component — those need to be registered in the application’s manifest as regular Java class files.

This is where Ruboto comes in.

Ruboto is a framework for a generic JRuby/Android application. It provides skeletal activities via a code generator and allows JRuby scripts to define handlers for all of

the lifecycle methods (e.g., `onCreate()`), plus define user interfaces using JRuby code, etc. The result can be packaged up as an APK file using supplied Rake script. The results can be uploaded to the Play Store or distributed however else you desire.

## Mono for Android

Mono is a re-implementation of C# and .NET for non-Windows environments. Mono has had its fair share of controversies, mostly stemming from Microsoft, such as whether Microsoft will someday squash Mono over patent considerations.

Mono for Android (previously known as MonoDroid) has been in the works for some time. This would allow Mono developers to target Android for their apps. In principle, one could develop C# applications for Android this way.

While Mono itself is an open source project, “Mono for Android is a commercial product... licensed on a per-developer basis”, according to the Mono project. This may come as a bit of a shock to those expecting Mono-on-Android to remain open source.

## App Inventor

App Inventor is an Android application development tool originally made available by Google, but outside of the normal Android developer site. App Inventor was originally developed for use in education, but they have been inviting others into their closed beta.

App Inventor is theoretically a Web-based development tool. Here, “theoretically” means that, in practice, users have to do a fair amount of work outside of the browser to get everything set up:

1. Have Java installed and functioning in the browser, capable of running Java Web Start (.jnlp) applications
2. Download and install a large (~55MB) client-side set of tools
3. Have a phone and have it configured to work with App Inventor and the Android SDK

Once set up, App Inventor gives you a drag-and-drop GUI editor:

## OTHER ALTERNATIVE ENVIRONMENTS

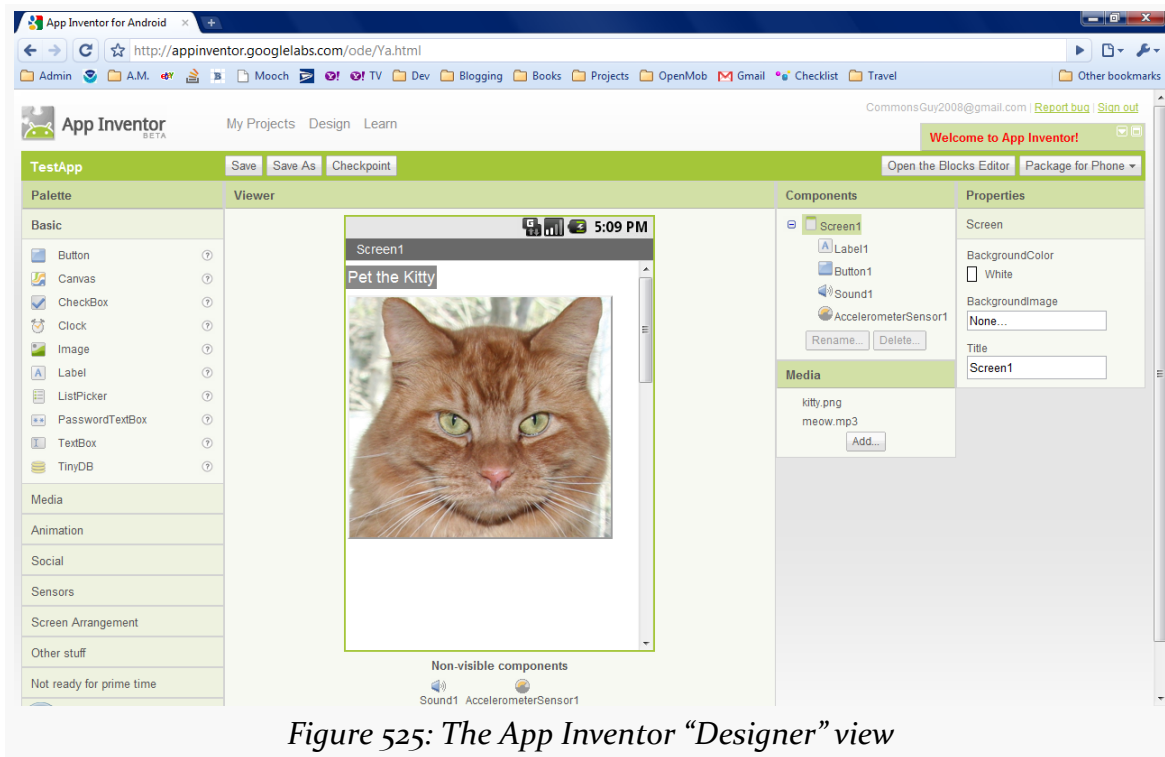


Figure 525: The App Inventor “Designer” view

... and a “blocks” editor, where you attach behaviors to events (e.g., button clicks) by snapping together various “blocks” representing events, methods, and properties:

## OTHER ALTERNATIVE ENVIRONMENTS

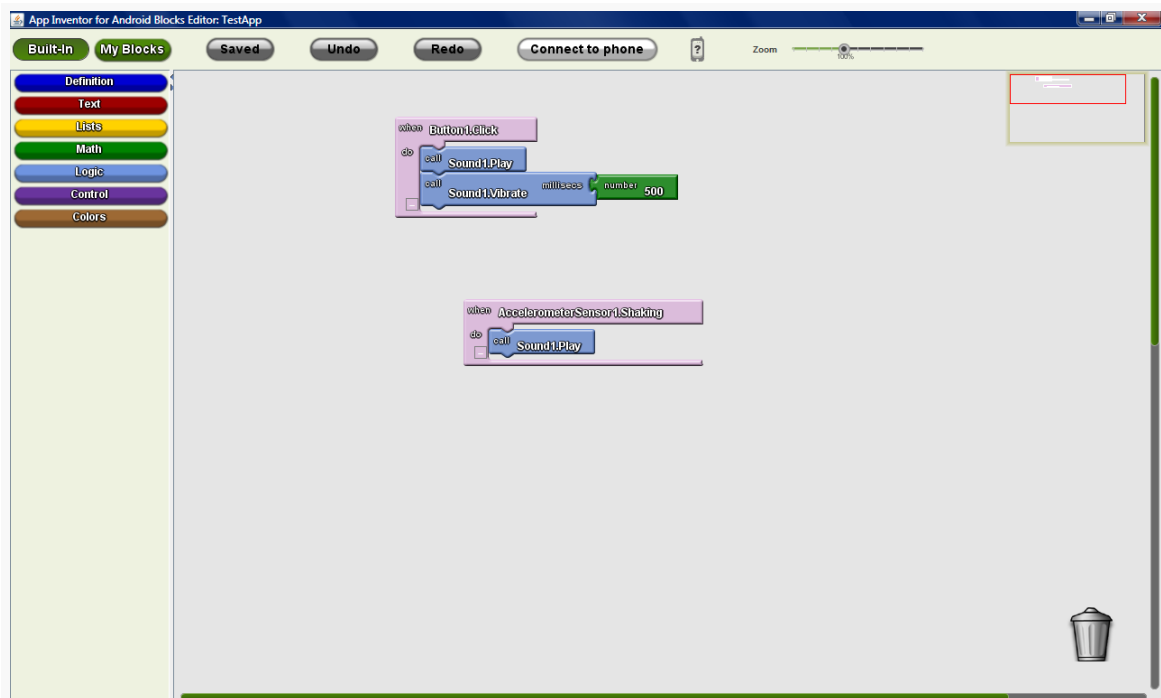


Figure 526: The App Inventor “Blocks” view

While working in the GUI editor, you see what you are building live on an attached phone and can be tested in real time. Later, when you are ready, you can package the application into a standard APK file.

However, App Inventor is not really set up for production application use today:

1. You cannot distribute App Inventor apps on the Play Store
2. It has more components aimed at “sizzle” (e.g., Twitter integration) and fewer delivering capabilities that a typical modern app might need (e.g., relational databases, lists)
3. Only one developer at a time can work on a project

In 2011, Google discontinued direct support for App Inventor, electing to transfer the project to MIT’s Media Lab for ongoing development.

## Titanium Mobile

Titanium Mobile’s claim to fame is using JavaScript to completely define the user interface, eschewing HTML entirely. Rather, their JavaScript library — in addition to



providing access to databases and platform capabilities — also lets you declare user interface widgets. Its layout capabilities, for positioning said widgets, leaves a bit to be desired.

As of the time of this writing, Appcelerator — the creators of Titanium Mobile — does not offer a cloud-based set of tools. Their Titanium tool has a very slick-looking UI, but it still requires the Java SDK and Android SDK in order to be able to build Android applications, making the setup a bit daunting for some.

As of the time of this writing, Titanium Mobile supports development for Android and iOS, with Blackberry support in a private beta.

## Other JVM Compiled Languages

If your issue is less with regular Android development, but you just do not like Java, any language that can generate compatible JVM bytecode should work with Android. You would have to modify the build chain for that other language to do the rest of the Android build process (e.g., generate R.java from the resources, create the APK file in the end).

Scala and Clojure are two such languages, for which their respective communities have put together instructions for using their languages for Android development.

# Anti-Patterns

---

Much of this book has been focused on what you should do. In contrast, this chapter is focused on what you should *not* do.

All platforms have their anti-patterns: things that are technically possible but are not in the best interests of the users of that platform. Android is no exception. Some anti-patterns are simply annoying to users, while other anti-patterns can significantly infringe upon a user's use of their Android device, or even the user's freedom.

Much as the Hippocratic Oath directs doctors to “first, do no harm”, Android application developers owe it to the users of their apps to avoid these anti-patterns to the greatest extent possible.

## Prerequisites

This chapter assumes that you have read much of the book, particularly the core chapters.

## Leak Threads... Or Things Attached to Threads

Leaking a thread means that you start a thread and never cause it to stop. For example, you might start a thread that runs in an infinite loop, doing some work and then sleeping for a while. The problem with infinite loops is that “infinite” is an awfully long time.

All threads should clean up, in a timely fashion, when the component (e.g., activity, service) that started the thread is destroyed — or, in the case of an activity, perhaps just moved into the background.

*How* you ensure that the thread gets cleaned up is up to you. For threads doing transactional work, such as literally running a database transaction, it may be fine to just let them run to completion and shut down of their own accord. For “infinite” loops, there should be some way to tell the thread that it is no longer needed, such as via an `AtomicBoolean` flag, or using something more structured than a plain timing loop, such as a `ScheduledExecutorService`.

Also, bear in mind that you are responsible for threads that are created, on your behalf, by other things that you do. The most common leak scenario here comes with listeners associated with system services, like `LocationManager` and `SensorManager`. If you register a `LocationListener` via `requestLocationUpdates()` and fail to unregister that listener, you will not only be leaking the listener, but the component associated with that listener, and every system resource tied to that listener, such as any background threads.

### The Costs

Threads are intrinsically static in scope. Hence, any object they can reach, directly or indirectly, cannot be garbage-collected while the thread is still running. Hence, if an activity forks a thread, it might do so using an anonymous inner class:

```
new Thread() {  
    public void run() {  
        // do something  
    }  
}.start();
```

Instances of an inner class — anonymous or otherwise — have an implicit reference back to the object that created them. Hence, the `Thread` would hold onto the `Activity` that created the thread, which in turn would hold onto all of its widgets and so forth. None of that can be garbage-collected until after the thread terminates, even if the activity is destroyed.

### The Counter-Arguments

**I want the thread to keep running even after the activity is destroyed**

In this case, the thread should be created and managed by a service, not simply leaked. Not only does this give you an opportunity to clean up the thread when needed, but it also alerts Android that you are still trying to do some work, so Android will not necessarily terminate your process very quickly.

However, be careful about assuming that you can have a thread — even one managed by a service — run forever, as you will see in the next couple of sections.

### **I do not know when the thread is no longer needed**

Then you have a serious design problem.

A common variation on this theme is:

### **The thread is needed so long as I have an activity in the foreground**

This is a bit tricky, as Android does not really expose the concept of *applications* being in the foreground, just activities.

The safest course of action is to have the thread be managed by a service, then keep track of whether or not you have an activity in the foreground. For example, in `onPause()` of each activity, use `postDelayed()` to return control to you after a short delay, and in `onResume()`, update a timestamp of your last return to the foreground (held in a static data member). When the `Runnable` for `postDelayed()` executes, check that timestamp — if it is too old, you know that none of your activities are in the foreground, and you can stop the service, having it stop your thread.

## **Use Large Heap Unnecessarily**

Encountering an `OutOfMemoryError` certainly sucks. These are caused either by a memory leak or by trying to use more memory than is practical given the device. For example, loading up lots of bitmaps can easily chew up your available heap space.

To some, therefore, `android:largeHeap` seems to be the perfect solution.

Added in API Level 11, `android:largeHeap` tells Android to give you a much larger heap size than is normally given to a process. So, instead of having 32MB or 48MB or so of heap, you might have 256MB of heap.

The right solution, in most cases, is to fix the underlying memory problem, not to mask it by requesting an over-sized heap.

### The Costs

To you, having hundreds of megabytes of extra heap may be a blessing. To the user, it may be a curse. That memory has to come from somewhere, and the “somewhere” is from other processes. Your app will force other apps’ processes to be terminated far more quickly than normal, which may slow the user down when she tries to switch between your app and others. Your app may even materially harm the functionality of other apps, who have their processes terminated before they can finish their work, just to satisfy your memory craving.

Bear in mind that Android does not employ swap space (the Linux equivalent of a Windows pagefile). Hence, whereas Windows can allocate lots of memory and slows down as it goes, Android is far more limited, in accordance with its mobile roots.

Furthermore, in many cases, adding more heap space does not eliminate the problem, any more than spraying air freshener gets rid of the dead cat in your living room that is causing the odor. With a memory leak, for example, all the larger heap does is increase the time before you eventually run out of memory.

### The Counter-Arguments

#### **I really need to be able to manipulate large chunks of memory**

There are certainly apps for which `android:largeHeap` is justified, such as complex data editors, such as image editors, video editors, etc.

Hence, in practice, the real anti-pattern is not using `android:largeHeap`, but rather in doing so for apps where the user would not feel that the resulting effects are justified. For example, neither a Twitter client, nor a banking app, should need a large heap, even if the developer is running into memory management issues.

#### **Android makes it too hard to manage memory, so I need a large heap**

There is no question that developing mobile applications is challenging, particularly when it comes to memory management. That is not unique to Android — embedded systems developers are used to writing apps where the heap size is better measured in KB instead of MB, for example.

Outside of bitmaps and massive data sets, though, it is a bit difficult to actually run out of memory. While a `TextView` may take up 1KB of heap space, it takes a *lot* of `TextView` widgets to chew through a 48MB heap.

The reason why bitmaps tend to trip up developers is that Android makes using them *too easy*. For example, it is simple to set a bitmap as a background of some container like a `LinearLayout`, where developers then blindly ignore the fact that if the bitmap is not *precisely* the size of the container, Android will need to scale the image, consuming more heap space.

## Misuse the MENU Button

The MENU button on Android devices is designed to display either the options menu (on Android 1.x/2.x devices that are not using something like `ActionBarSherlock`) or the action bar overflow menu.

The MENU button is *not* designed for any other purpose. Some developers have taken to using it for arbitrary aims, and that is a mistake.

## The Costs

The MENU button does not exist on many Android devices. In particular, devices designed for Android 3.0 and higher do not *need* a MENU button. Some will have them, but most will not. Hence, anything that requires the MENU button will simply be unavailable on those devices.

## The Counter-Arguments

**Well, if I keep `targetSdkVersion` below 11, I can have a soft MENU button**

This is true, insofar as a menu affordance will be added to the system bar or navigation bar on devices that lack a dedicated MENU button.

Whether the *user* is expecting to use this button is another thing entirely.

As more and more users run Android 3.0+ devices, they will use more and more apps that have `android:targetSdkVersion` set to 11 or higher. The remaining handful of apps that do not will be “weird”. In particular, they may not notice the menu affordance, as they are not looking for one, or they may not know what it does, as they are not used to needing it.

Moreover, eventually, other things will drive you to want an `android:targetSdkVersion` higher than 10, as the menu affordance is not the only feature driven by this value. The sooner you can remove your dependence on a

menu affordance, the sooner you can upgrade your `android:targetSdkVersion` to solve other problems that you are encountering.

### **I think the action bar is ugly, a waste of space, or otherwise bad**

That's nice. It does not mean that you need a menu affordance and a tie to a MENU button.

For example, well-written games will have a menu integrated into the game UI itself. This was often done even before Android 3.0, since the options menu UI would not look much like the game's UI, and the developer wanted a consistent look-and-feel.

So long as the user recognizes how to reach the menu (e.g., a three-dots or three-bars icon), the menu does not have to be driven by Android, but instead could be handled by your app directly. You can see this in the Google Navigation app, which avoids an action bar but still displays its own menu from its own on-screen menu affordance.

## **Interfere with Navigation**

Some developers try to take over the device. They attempt to block the use of anything not related to their app: the HOME key, the recent tasks list, the notification drawer, etc.

Android treats such behavior as malware. Android is designed to keep control of the device in the hands of the user and tries very hard to prevent apps from stealing that control.

### **The Costs**

While there are certain cases where blocking navigation outside the app may seem justified (see the counter-arguments, below), there is simply too much opportunity for malfeasance. Users tend to want to use their devices on their terms, not necessarily the terms of some random developer. Malware authors, in particular, love to learn about script-kiddie hacks that allow them to control a device, and by extension, control the users.

### **The Counter-Arguments**

**I am writing a lock screen**

No, you are not. You are writing something that you *think* is a lock screen. Really what you are writing is something that weakens device security... if the app in question is designed to be downloaded and run on arbitrary devices.

Android devices can be rebooted into “safe mode”. Much like the Windows boot option that bears the same name, “safe mode” only runs apps that are part of the system firmware, not any third-party apps.

So, let’s assume that the user installs your “lock screen”. Inevitably, part of the setup of a third-party “lock screen” is to disable any sort of security that is part of the native lock screen, so the user does not have to unlock things twice. Even though your lock screen may implement all sorts of security, all somebody else has to do is reboot the device in safe mode, and they now have complete access to the device, including the ability to uninstall your lock screen. By contrast, the native lock screen is in force even if the device reboots in safe mode.

### **I am writing a parental control app**

Rebooting in safe mode is within the motor-control skills of your average three-year-old child. Hence, the primary limitation is whether or not the child knows *how* reboot the device in safe mode, which they can learn from the Internet, friends, etc. And, if the device is really an adult’s device, where the “lock screen” allows access to a subset of child-friendly apps, the real risk is not from the child rebooting the device in safe mode, but from the crook who steals the device rebooting in safe mode.

### **I am writing a lock screen designed to run on whole-disk-encrypted devices**

While whole disk encryption — available on Android 4.0+ — does solve the issue of rebooting in safe mode, bear in mind that users then cannot disable the required password security on the native lock screen, as that is tied into the whole disk encryption process.

### **I am writing a kiosk app**

Here, the term “kiosk app” refers to an app that represents the functionality of a single-purpose device. For example, a restaurant might want to distribute menus to customers in the form of a tablet app; the menu app would be the “kiosk app”.



In this case, the owner of the device is the one trying to lock it down to be single-purpose. That is completely reasonable... except that it runs counter to the behavior of standard consumer builds of Android.

The right solution, in this case, is to create custom firmware for the single-purpose devices. This firmware can set up the kiosk app to be the home screen (thereby blunting the effectiveness of HOME, BACK, etc.), and modifications to the firmware can apply access controls to other aspects of the device (e.g., notifications). Unfortunately, there are few (if any) businesses set up to help create such single-purpose firmware for single-purpose devices.

## Use `android:sharedUserId`

If you are creating more than one application, where those applications should be sharing data, you may be tempted to use `android:sharedUserId`. This attribute, applied to the root `<manifest>` element in your manifest, allows two or more apps to share a Linux user account. That will allow these apps full access to the other apps' files. The limitations are that you must use the same value for `sharedUserId` and that all such apps must be signed with the same signing key.

However, this is a fairly crude and somewhat risky approach to sharing information between apps. In most cases, you will be better served using any of the structured IPC options within Android, such as remote services and content providers.

## The Costs

First, you must make the decision to use `android:sharedUserId` before you ever ship your app in production. Should you change the `sharedUserId` value — or switch from no value to a new value — when your change is installed, the new version of your app will have no rights to access the old version of your app's files. This is unlikely to turn out well.

Second, it will be up to you to maintain data integrity of these files in the face of simultaneous access from multiple apps. SQLite should handle this for you for your databases, as it is set up to use process-level locking — this is why SQLite can be used as the out-of-the-box database solution for Web frameworks like Rails. However, any other sort of file, including `SharedPreferences`, will lack that coordination, unless you somehow arrange to do it yourself. And even the SQLite-level coordination has its limits, as one app has no way to know about another app's changes to the data, except by re-querying the database.

Third, using `android:sharedUserId` limits your flexibility. You cannot use it with third-party apps. You cannot readily sell one of your apps in your suite, as then it becomes a third-party app and can no longer be signed by the same signing key as are the rest of your apps. Basically, `sharedUserId` causes multiple separate APKs to behave, in some respects, as one larger APK.

### The Counter-Arguments

#### I need to ensure only my apps can share the data, not others

Use a signature-level permission. This gives you the same level of security as does `android:sharedUserId` without most of the risks.

#### Writing IPC code is tedious

So is writing cross-process data integrity code.

### Implement a “Quit” Button

Perhaps the most contentious question and answer on StackOverflow’s `android` tag is [“Quitting an application - is that frowned upon?”](#). This exchange is nearly three years old (as of the time of this writing), yet the answer receives both upvotes (and a few downvotes) with some regularity.

Other Android experts, such as Reto Meier, have weighed in on the issue and have [offered similar recommendations](#) – that is, do not have a “quit” or “exit” button in your app.

(here, “button” is shorthand for any command-style interface, and includes menu options, action bar items, and the like by extension)

The reason is simple: whatever your “quit” or “exit” button does *should be happening in other conditions as well*, and handling those other conditions should eliminate the need for the button.

If the app moves into the background *for any reason*, you need to treat the user and her device with respect. This means stopping background threads that are not needed, releasing system resources like the GPS radio (immediately or after a modest delay), and the like. The user should not need to “quit” your app to

accomplish this, because your app will move to the background for other reasons, such as incoming phone calls, or the user pressing the HOME button.

### The Costs

You might think “well, what’s the harm in having the ‘quit’ button that, say, just calls `finish()`?”

First, rarely is it that simple. Calling `finish()` will return the user to the previous activity, and so for any multi-activity app, there will be scenarios where `finish()` is not really “quit”. The only simple thing you can universally do is have “quit” bring up the home screen, in which case all you have done is waste screen real estate duplicating the HOME button functionality. Worse, the developer might say “oh, well, I will just terminate my process when they press ‘quit’”, and *that* anti-pattern [is coming up next in this chapter](#).

Second, the user will start to think that they *need* to press “quit”, or else bad things might happen. They will see an explicit “quit” option and start to wonder “well, gee, when am I supposed to press that, and what happens if I do not?” This, in turn, will lead to the user going out of their way to make sure to press your “quit” button, even if doing so does not actually change anything about the behavior of your app, courtesy of [the placebo effect](#).

### The Counter-Arguments

#### **I need to let the user log out of the app, so I need a “quit” button**

No, you need a “logout” button that clears your cached authentication credentials (e.g., sets a static data member to `null`), then brings up the login activity using `FLAG_ACTIVITY_SINGLE_TOP` and `FLAG_ACTIVITY_CLEAR_TOP` to wipe out all other activities in your process. And, probably, you need to have some sort of inactivity-based “timeout” that also logs out the user (e.g., sets that static data member to `null`).

#### **I am running stuff in the background, so I need a “quit” button**

No, you need a “stop that background stuff” button, preferably with a shorter, more specific label. And, you need that to also be available from the Notification that you are using with your foreground service, where applicable.

## Terminate Your Process

Closely related to the above anti-pattern is to forcibly stop your process, such as via `System.exit()`, `Runtime.exit()`, `Process#killProcess()`, and so forth. These are often used in concert with [an in-app “quit” button](#), or sometimes for other reasons (e.g., could not figure out how to handle an exception gracefully).

### The Costs

Simply put, Google has warned, repeatedly, that there may be side effects from terminating your own process, rather than having Android do proper cleanup first.

- “You should really think about not exiting the application. This is not how Android apps usually work.” ([Romain Guy](#))
- “To be clear: using `System.exit()` is strongly recommended against, and can cause some poor interactions with the system. Please don’t design your app to need it.” ([Dianne Hackborn](#))
- “There is no reason or need to call `[exit()]`” ([Dianne Hackborn](#))
- “Nobody has said anything about `Process.kill()` not doing anything. You want to kill your *own* process and cause the user to experience your *own* application having weird behavior at times due to it? Have at it. I just want to be clear that this is not what we recommend doing... and you are likely to cause bad behavior in your app at least at times due to it... There is no API to quit an application, because there is no such concept on Android, and trying to implement such a thing is going to result in fighting against how Android works.” ([Dianne Hackborn](#))

### The Counter-Arguments

#### **I am using a C library that is buggy, so I need to terminate my process**

Fix the bugs in the library. For example, C libraries that rely too heavily on global variables may need to be adjusted to use session handles that get passed around.

#### **Well, it is not my C library, but one from a third party, so I need to terminate my process**

Find a library that is Android-compatible, then. It is likely that you will encounter other problems with this library, if it is not designed to work on Android (e.g., not set up to work properly on ARM CPUs).

### **There is a bug in Android for which I have found no workaround short of terminating my process**

This is one of the few legitimate reasons for terminating a process, but it is so rare that it is difficult to find a citation of a place where such a bug (and workaround) exists.

### **I need to do *something* from my top-level exception handler!**

Set relevant static data members to null, then start up your launcher activity, using `FLAG_ACTIVITY_SINGLE_TOP` and `FLAG_ACTIVITY_CLEAR_TOP` to wipe out all other activities in your task. This should reset you to your original state, as if the user had launched the app.

## **Try to Hide from the User**

Some developers view the user as the enemy. These developers try to insulate their app from the user, to make data inaccessible to the user, to make the app “unkillable” by the user, etc. In many cases, this is as the behest of some enterprise, wanting to exert control over the user’s use of the app or even the device.

Android is a consumer operating system. It is designed to put power in the hands of whoever is holding the device and can authenticate themselves to the device (e.g., via a password on the lock screen). Enterprises and malware authors have much the same interests: they wish to take control away from the user and give the control to somebody else. Android defends against malware; enterprises get caught in the crossfire.

Inevitably, the right solution here will be an enterprise remix of Android, designed to be loaded on enterprise-supplied devices, that put the control in the hands of the enterprise.

## **The Costs**

Simply put, you are wasting your time, which could be better spent on other pursuits.

With respect to data, if your app can access that data, by definition, a sufficiently talented user can get at the data:

- If you put it on internal storage, the user can root the device
- If you further encrypt the data, the user can find the encryption algorithm and key in your app, then decrypt the data
- If you try obfuscation or other techniques to mask the encryption algorithm and key, the user will use cracking tools to find this information anyway, or will transfer your app to a ROM mod that contains a modified version of the Android framework that can collect this information when you go to decrypt the data
- And so on

With respect to the process, the user can force-stop anything installed app via the Settings app. And, even if you use script-kiddie tricks to try to prevent access to Settings, the user can nuke your app from orbit via the command line, using the full Android SDK or third-party tools.

### The Counter-Arguments

#### **I am creating an app for an enterprise, and we need to control the app**

Then you further need to control the device, which leads to the “enterprise flavor of Android” solution mentioned earlier in this section.

#### **I am creating a lock screen/parental control app/kiosk app**

Please see the counter-arguments for “Interfering with Navigation” from [earlier in this chapter](#).

### Use Multiple Processes

Some Android professionals recommend the use of `android:process` to have components run in separate processes from the main one for an application. For example, you might have all of your activities in the main process but isolate a service in a separate process. Or, you might have some memory-intensive activity (e.g., an image editor) run in a separate process.

As with most of these anti-patterns, while the `android:process` feature is valid, it is rarely necessary. To some extent, developers get caught up in process isolation from its use on servers and forget that mobile devices typically have fewer resources — RAM and CPU — than do their server counterparts. Few of Google’s apps use `android:process`; even complex apps like Gmail or the original Browser avoid it.

### The Costs

Each process gets its own heap space, cutting into the heap available for other applications. As with the large-heap anti-pattern [discussed above](#), this will tend to force other apps to be ejected from memory sooner than normal, with commensurate impacts on user experience.

Inter-process communication (IPC) is not cheap, compared with normal method invocation within a process. Hence, tightly-coupled processes will chew through more CPU than their single-process counterparts. While it is unlikely that you will see major performance implications (unless you are doing a preposterous amount of IPC), this will consume more battery than is otherwise warranted.

### The Counter-Arguments

**I am using a C library that is buggy, and you told me not to terminate my process**

As noted earlier, fix the bugs in the library.

**Hello? It is not my C library, but one from a third party!**

Find a library that is Android-compatible, then.

**I need more heap space**

On Android 3.0 and higher, `android:largeHeap` is available, though its misuse is [another anti-pattern, discussed above](#). However, prior to Android 3.0, `android:largeHeap` was not an option. One workaround used by some apps is to fork several processes, thereby getting several “small” heap allocations (e.g., 32MB) instead of just one.

In cases where `android:largeHeap` is indeed justified, using multiple processes as a workaround on older Android versions is justified as well. However, bear in mind that IPC overhead is non-trivial, so have a plan to dump the multiple processes and use `android:largeHeap` once you drop support for Android 1.x/2.x.

**I want my UI not to freeze when doing background work**

Use threads, not processes, for this.

## Do Not Hog System Resources

Some of these anti-patterns, like the multiple-process one just now, are really concrete sub-types of a more general anti-pattern: assuming yours is the only app running on the device. While your app may be the only one running in the foreground (assuming that you actually *are* in the foreground), there are other apps in the background, and ones that soon will come to the foreground. You need to “play nice” and ensure that these other apps will have their fair share of system resources.

One example is open files on external storage. For some devices — but not all — there is a limit of 1,024 simultaneously open files. In principle, that should be plenty. However, if some app — maybe yours? — opens a whole bunch of files, it is possible that other apps trying to access external storage at that point will crash because the limit was hit.

### The Counter-Arguments

**Um, well, I’m just more important than those other developers**

::facepalm::





# Widget Catalog: AdapterViewFlipper

---

A [regular ViewPager](#) shows only one child widget or container at a time. So does an AdapterViewFlipper. The difference is where the children come from. With a regular ViewPager, you add children much like you would any other standard container class, such as defining the children in your layout XML resource. With AdapterViewFlipper, the children come from an Adapter.

While AdapterViewFlipper does not inherit from ViewPager (or vice versa, for that matter), their public API is largely the same:

- You can control which child is visible, either by index or via `showNext()/showPrevious()` methods to rotate between them.
- You can set up [animated effects](#) to control how a child leaves and the next one enters, such as applying a sliding effect.
- You can set up AdapterViewFlipper to automatically flip between children on a specified period.

There are two key advantages for AdapterViewFlipper:

1. Since it uses an Adapter model, it can be more memory efficient for lots of children, through child view recycling
2. It is available for use in an [app widget](#)

However, AdapterViewFlipper is new to API Level 11 and is unavailable on older versions of Android. It is not included in the Android Support package backport.

## Key Usage Tips

All of the usage tips from [ViewPager](#) are relevant for AdapterViewFlipper.

### A Sample Usage

The sample project can be found in [WidgetCatalog/AdapterViewFlipper](#).

Layout:

```
<?xml version="1.0" encoding="utf-8"?>
<AdapterViewFlipper xmlns:android="http://schemas.android.com/apk/res/android"
    android:id="@+id/details"
    android:layout_width="fill_parent"
    android:layout_height="fill_parent"/>
```

Activity:

```
package com.commonware.android.avflip;

import android.app.Activity;
import android.os.Bundle;
import android.widget.AdapterViewFlipper;
import android.widget.ArrayAdapter;

public class FlipperDemo2 extends Activity {
    static String[] items= { "lorem", "ipsum", "dolor", "sit", "amet",
        "consectetuer", "adipiscing", "elit", "morbi", "vel", "ligula",
        "vitae", "arcu", "aliquet", "mollis", "etiam", "vel", "erat",
        "placerat", "ante", "porttitor", "sodales", "pellentesque",
        "augue", "purus" };
    AdapterViewFlipper flipper;

    @Override
    public void onCreate(Bundle icle) {
        super.onCreate(icle);
        setContentView(R.layout.main);

        flipper=(AdapterViewFlipper)findViewById(R.id.details);
        flipper.setAdapter(new ArrayAdapter<String>(this, R.layout.big_button,
items));
        flipper.setFlipInterval(2000);
        flipper.startFlipping();
    }
}
```

### Visual Representation

There is no visual representation of an AdapterViewFlipper itself, as it renders no pixels on its own. Rather, it simply shows the current child.

# Widget Catalog: DatePicker

---

DatePicker, as the name might suggest, allows the user to pick a date. You supply a starting date, which the user then manipulates, triggering event listeners whenever the date is changed.

## Key Usage Tips

If you do nothing, the DatePicker will start with today's date. However, if you want to set up an `OnDateSetListener` to find out when the date changes, you will need to call `init()` to do so, in which you also need to set the date.

DatePicker works well with `Calendar` and `GregorianCalendar`, in terms of setting and getting the year/month/day-of-month from the DatePicker and converting it into something you can use in your code.

API Level 11 introduced an optional `CalendarView` adjunct to the DatePicker, determined via `setCalendarViewShown()` or `android:calendarViewShown`. This works well on `-normal` screens in landscape and on `-large/-xlarge` screens. On `-normal` screens in portrait, the year portion of the picker may be chopped off to save room. Using the `CalendarView` option on `-small` screens is probably not a good idea.

## A Sample Usage

The sample project can be found in [WidgetCatalog/DatePicker](#).

Layout:

## WIDGET CATALOG: DATEPICKER

---

```
<LinearLayout xmlns:android="http://schemas.android.com/apk/res/android"
    android:layout_width="match_parent"
    android:layout_height="match_parent"
    android:orientation="vertical"
    android:gravity="center_horizontal">

    <DatePicker
        android:id="@+id/picker"
        android:layout_width="match_parent"
        android:layout_height="0dip"
        android:layout_weight="1"
        android:calendarViewShown="true"/>

    <CheckBox
        android:id="@+id/showCalendar"
        android:layout_width="wrap_content"
        android:layout_height="wrap_content"
        android:checked="true"
        android:text="@string/calendar"/>

</LinearLayout>
```

Activity:

```
package com.commonware.android.wc.datepick;

import android.app.Activity;
import android.os.Build;
import android.os.Bundle;
import android.view.View;
import android.widget.CheckBox;
import android.widget.CompoundButton;
import android.widget.CompoundButton.OnCheckedChangeListener;
import android.widget.DatePicker;
import android.widget.DatePicker.OnDateChangeListener;
import android.widget.Toast;
import java.util.Calendar;
import java.util.GregorianCalendar;

public class DatePickerDemoActivity extends Activity implements
    OnCheckedChangeListener, OnDateChangeListener {
    DatePicker picker=null;

    @Override
    public void onCreate(Bundle savedInstanceState) {
        super.onCreate(savedInstanceState);
        setContentView(R.layout.main);

        CheckBox cb=(CheckBox)findViewById(R.id.showCalendar);

        if (Build.VERSION.SDK_INT>=Build.VERSION_CODES.HONEYCOMB) {
            cb.setOnCheckedChangeListener(this);
        }
    }
}
```

```
else {
    cb.setVisibility(View.GONE);
}

GregorianCalendar now=new GregorianCalendar();

picker=(DatePicker)findViewById(R.id.picker);
picker.init(now.get(Calendar.YEAR), now.get(Calendar.MONTH),
            now.get(Calendar.DAY_OF_MONTH), this);
}

@Override
public void onCheckedChanged(CompoundButton buttonView,
                             boolean isChecked) {
    picker.setCalendarViewShown(isChecked);
}

@Override
public void onChanged(DatePicker view, int year, int monthOfYear,
                     int dayOfMonth) {
    Calendar then=new GregorianCalendar(year, monthOfYear, dayOfMonth);

    Toast.makeText(this, then.getTime().toString(), Toast.LENGTH_LONG)
        .show();
}
}
```

The CheckBox is tied to the visibility of the CalendarView. Since this is only available on API Level 11 and higher, we simply remove the CheckBox on earlier versions of Android, so we do not have to worry about whether or not the CheckBox gets unchecked by the user.

## Visual Representation

This is what a DatePicker looks like in a few different Android versions and configurations, based upon the sample app shown above.

## WIDGET CATALOG: DATEPICKER

---

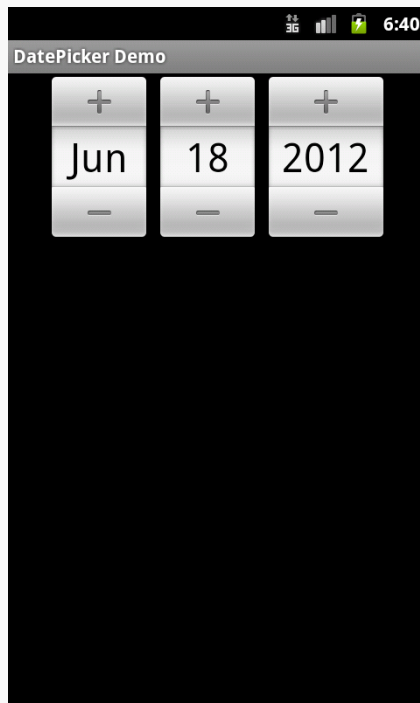


Figure 527: Android 2.3.3

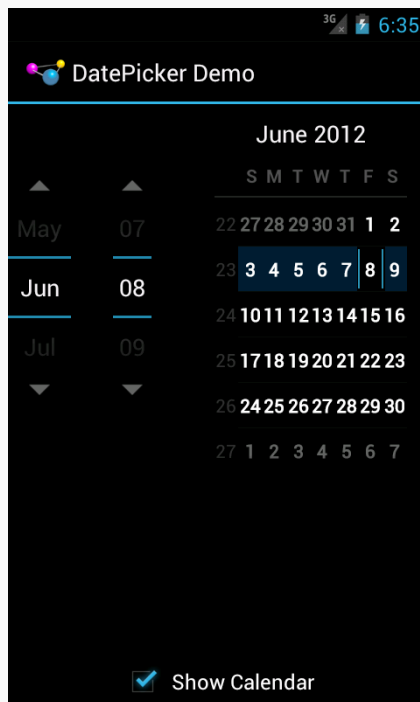


Figure 528: Android 4.0.3, with CalendarView, Portrait

## WIDGET CATALOG: DATEPICKER

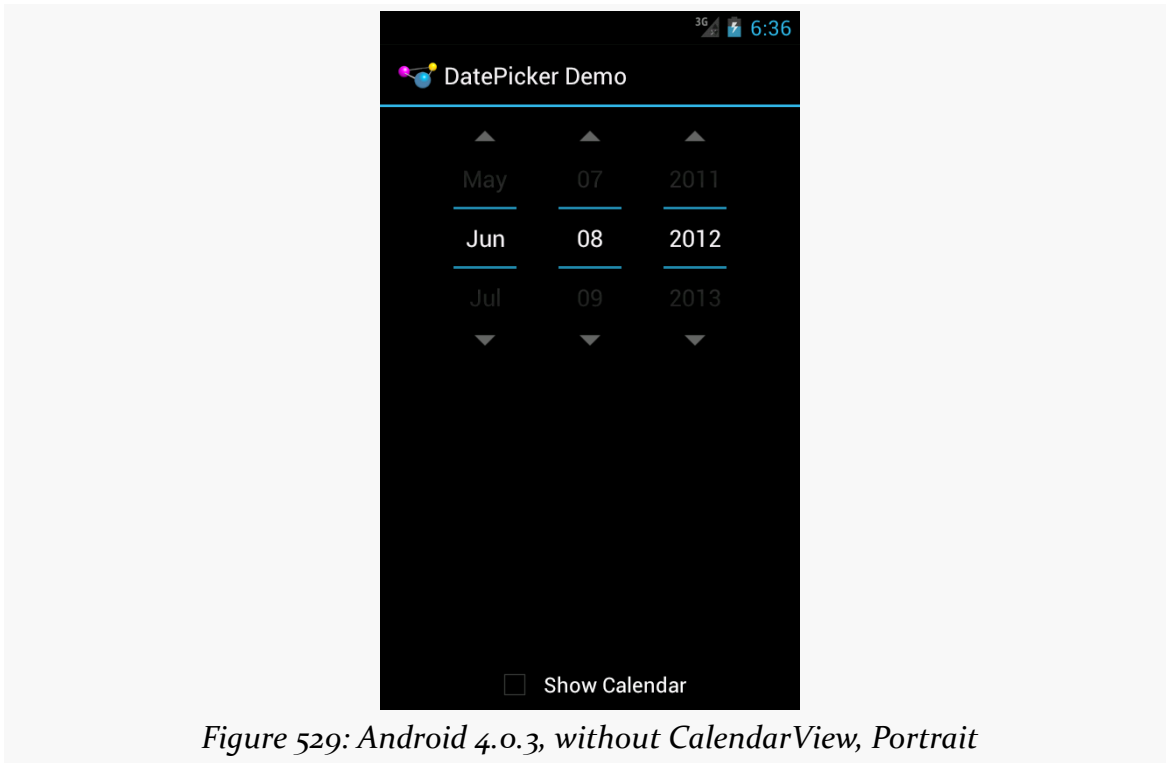


Figure 529: Android 4.0.3, without CalendarView, Portrait

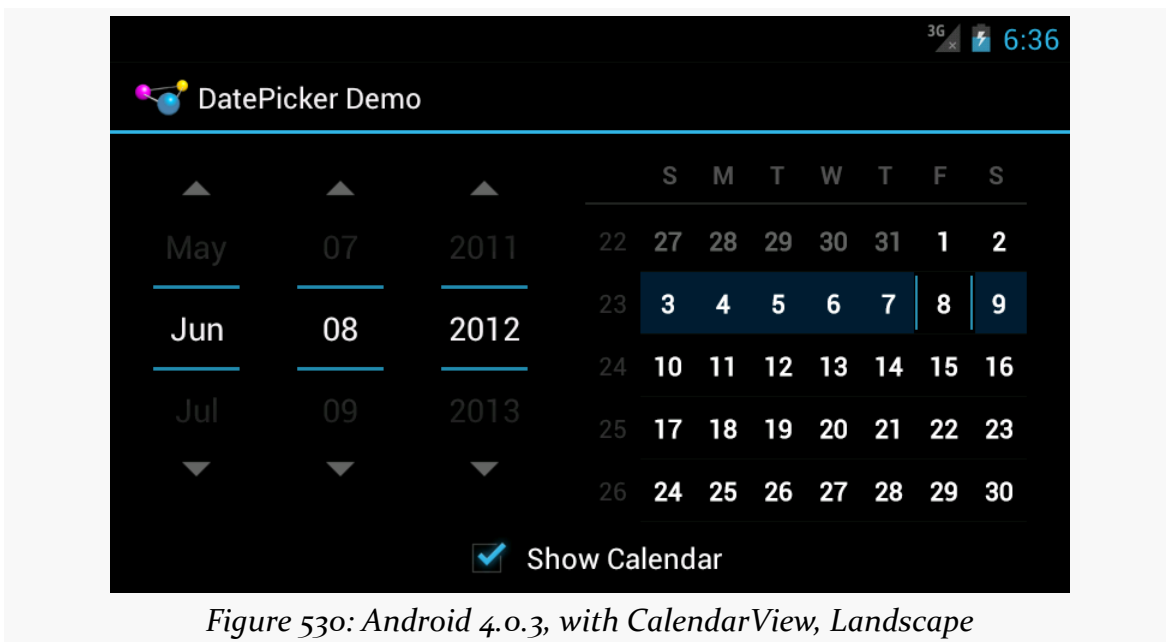


Figure 530: Android 4.0.3, with CalendarView, Landscape





# **Widget Catalog: ExpandableListView**

---

Android does not have a “tree” widget, allowing users to navigate an arbitrary hierarchy of stuff. In large part, that is because such trees are difficult to navigate on small touchscreens with comparatively large fingers.

Android *does* have `ExpandableListView`, a subclass of `ListView` that supports a two-layer hierarchy: groups and children. Groups can be expanded to show their children or collapsed to hide them, and you can get control on various events for the groups or the children.

## **Key Usage Tips**

Android offers an `ExpandableListActivity` as a counterpart to its `ListActivity`. However, it does not offer an `ExpandableListFragment`. This is not a major issue, as you can work with an `ExpandableListView` inside a regular `Fragment` yourself, just as you would for most other widgets not named `ListView`.

Rather than use a `ListAdapter` with `ExpandableListView`, you will use an `ExpandableListAdapter`, where you can control separate details for groups and children. These include:

- `SimpleExpandableListAdapter`, roughly analogous to `ArrayAdapter`, where your data resides in a `List` of `Map` objects for groups, and a `List` of a `List` of `Map` objects for the children
- `CursorTreeAdapter` and `SimpleCursorTreeAdapter`, roughly analogous to `CursorAdapter` and `SimpleCursorAdapter`, for mapping data in a `Cursor` to rows and columns

In many cases, though, the complexity of managing groups and children will steer you down the path of extending `BaseExpandableListAdapter` and handling all of the view construction yourself. There are many methods that you will need to implement:

- `getGroupCount()`, to return the number of groups
- `getGroup()` and `getGroupId()`, to return an `Object` and unique `int` ID for a group given its position
- `getGroupView()`, to return the `View` that should be used to render the group, perhaps using the built-in `android.R.layout.simple_expandable_list_item_1` that is set up for such groups and handles rendering the expanded and collapsed states
- `getChildrenCount()`, to return the number of children for a given group
- `getChild()` and `getChildId()`, to return an `Object` and unique `int` ID for a child given its position (and its group's position)
- `getChildView()`, to return the `View` that should be used to render the child, given its position and its group's position
- `isChildSelectable()`, to indicate if the user can select a given child, given its position and its group's position
- `hasStableIds()`, to indicate if the ID values you returned from `getGroupId()` and `getChildId()` will remain constant for the life of this adapter

There are four major events that you will be able to respond to with respect to the user's interaction with an `ExpandableListView`:

- Clicks on a child (`setOnChildClickListener()`)
- Clicks on a group (`setOnGroupClickListener()`)
- When groups expand (`setOnGroupExpandListener()`) or collapse (`setOnGroupCollapseListener()`)

If you use `setOnGroupClickListener()` to be notified about clicks on a group, be sure to return `false` from your implementation of the `onGroupClick()` method required by the `OnGroupClickListener` interface. If you return `true`, you consume the click event, which prevents `ExpandableListView` from using that event to expand or collapse the group.

## A Sample Usage

The sample project can be found in [WidgetCatalog/ExpandableListView](#).

## WIDGET CATALOG: EXPANDABLELISTVIEW

---

Layout:

```
<ExpandableListView xmlns:android="http://schemas.android.com/apk/res/android"
    android:id="@+id/elv"
    android:layout_width="fill_parent"
    android:layout_height="fill_parent">
</ExpandableListView>
```

JSON data:

```
{
  "Group A": ["Child A1", "Child A2", "Child A3"],
  "Group B": ["Child B1", "Child B2"],
  "Group C": ["Child C1"],
  "Group D": [],
  "Group E": ["Child E1", "Child E2", "Child E3"]
}
```

Activity:

```
package com.commonware.android.wc.elv;

import android.app.Activity;
import android.os.Bundle;
import android.util.Log;
import android.view.View;
import android.widget.ExpandableListAdapter;
import android.widget.ExpandableListView;
import android.widget.ExpandableListView.OnChildClickListener;
import android.widget.ExpandableListView.OnGroupClickListener;
import android.widget.ExpandableListView.OnGroupCollapseListener;
import android.widget.ExpandableListView.OnGroupExpandListener;
import android.widget.Toast;
import java.io.BufferedReader;
import java.io.InputStream;
import java.io.InputStreamReader;
import org.json.JSONObject;

public class MainActivity extends Activity implements
    OnChildClickListener, OnGroupClickListener, OnGroupExpandListener,
    OnGroupCollapseListener {
    private ExpandableListAdapter adapter=null;

    @Override
    public void onCreate(Bundle savedInstanceState) {
        super.onCreate(savedInstanceState);
        setContentView(R.layout.activity_main);

        InputStream raw=getResources().openRawResource(R.raw.sample);
        BufferedReader in=new BufferedReader(new InputStreamReader(raw));
        String str;
```

## WIDGET CATALOG: EXPANDABLELISTVIEW

---

```
StringBuffer buf=new StringBuffer();

try {
    while ((str=in.readLine()) != null) {
        buf.append(str);
        buf.append('\n');
    }

    in.close();

    JSONObject model=new JSONObject(buf.toString());

    ExpandableListView elv=(ExpandableListView)findViewById(R.id.elv);

    adapter=new JSONExpandableListAdapter(getLayoutInflater(), model);
    elv.setAdapter(adapter);

    elv.setOnChildClickListener(this);
    elv.setOnGroupClickListener(this);
    elv.setOnGroupExpandListener(this);
    elv.setOnGroupCollapseListener(this);
}
catch (Exception e) {
    Log.e(getClass().getName(), "Exception reading JSON", e);
}
}

@Override
public boolean onChildClick(ExpandableListView parent, View v,
                            int groupPosition, int childPosition,
                            long id) {
    Toast.makeText(this,
                  adapter.getChild(groupPosition, childPosition)
                    .toString(), Toast.LENGTH_SHORT).show();

    return(false);
}

@Override
public boolean onGroupClick(ExpandableListView parent, View v,
                            int groupPosition, long id) {
    Toast.makeText(this, adapter.getGroup(groupPosition).toString(),
                  Toast.LENGTH_SHORT).show();

    return(false);
}

@Override
public void onGroupExpand(int groupPosition) {
    Toast.makeText(this,
                  "Expanding: "
                    + adapter.getGroup(groupPosition).toString(),
                  Toast.LENGTH_SHORT).show();
}
}
```

```
@Override
public void onGroupCollapse(int groupPosition) {
    Toast.makeText(this,
        "Collapsing: "
            + adapter.getGroup(groupPosition).toString(),
        Toast.LENGTH_SHORT).show();
}
}
```

This activity loads up a JSON file from a raw resource on the main application thread in `onCreate()`, which is not a good idea. It would be better to do that work in a background thread, perhaps an `AsyncTask` managed by a retained fragment. The implementation shown here is designed to keep the sample small, not to demonstrate the best way to load data from a raw resource.

Adapter:

```
package com.commonsware.android.wc.elv;

import android.util.Log;
import android.view.LayoutInflater;
import android.view.View;
import android.view.ViewGroup;
import android.widget.BaseExpandableListAdapter;
import android.widget.TextView;
import java.util.Iterator;
import org.json.JSONArray;
import org.json.JSONException;
import org.json.JSONObject;

public class JSONExpandableListAdapter extends
    BaseExpandableListAdapter {
    LayoutInflater inflater=null;
    JSONObject model=null;

    JSONExpandableListAdapter(LayoutInflater inflater, JSONObject model) {
        this.inflater=inflater;
        this.model=model;
    }

    @Override
    public int getGroupCount() {
        return(model.length());
    }

    @Override
    public Object getGroup(int groupPosition) {
        @SuppressWarnings("rawtypes")
        Iterator i=model.keys();
    }
}
```

## WIDGET CATALOG: EXPANDABLELISTVIEW

---

```
while (groupPosition > 0) {
    i.next();
    groupPosition--;
}

return(i.next());
}

@Override
public long getGroupId(int groupPosition) {
    return(groupPosition);
}

@Override
public View getView(int groupPosition, boolean isExpanded,
                    View convertView, ViewGroup parent) {
    if (convertView == null) {
        convertView=
            inflater.inflate(android.R.layout.simple_expandable_list_item_1,
                            parent, false);
    }

    TextView tv=
        ((TextView)convertView.findViewById(android.R.id.text1));
    tv.setText(getGroup(groupPosition).toString());

    return(convertView);
}

@Override
public int getChildrenCount(int groupPosition) {
    try {
        JSONArray children=getChildren(groupPosition);

        return(children.length());
    }
    catch (JSONException e) {
        // JSONArray is really annoying
        Log.e(getClass().getSimpleName(), "Exception getting children", e);
    }

    return(0);
}

@Override
public Object getChild(int groupPosition, int childPosition) {
    try {
        JSONArray children=getChildren(groupPosition);

        return(children.get(childPosition));
    }
    catch (JSONException e) {
        // JSONArray is really annoying
        Log.e(getClass().getSimpleName(),
```

## WIDGET CATALOG: EXPANDABLELISTVIEW

---

```
        "Exception getting item from JSON array", e);
    }

    return(null);
}

@Override
public long getChildId(int groupPosition, int childPosition) {
    return(groupPosition * 1024 + childPosition);
}

@Override
public View getChildView(int groupPosition, int childPosition,
                        boolean isLastChild, View convertView,
                        ViewGroup parent) {
    if (convertView == null) {
        convertView=
            inflater.inflate(android.R.layout.simple_list_item_1, parent,
                            false);
    }

    TextView tv=(TextView)convertView;
    tv.setText(getChild(groupPosition, childPosition).toString());

    return(convertView);
}

@Override
public boolean isChildSelectable(int groupPosition, int childPosition) {
    return(true);
}

@Override
public boolean hasStableIds() {
    return(true);
}

private JSONArray getChildren(int groupPosition) throws JSONException {
    String key=getGroup(groupPosition).toString();

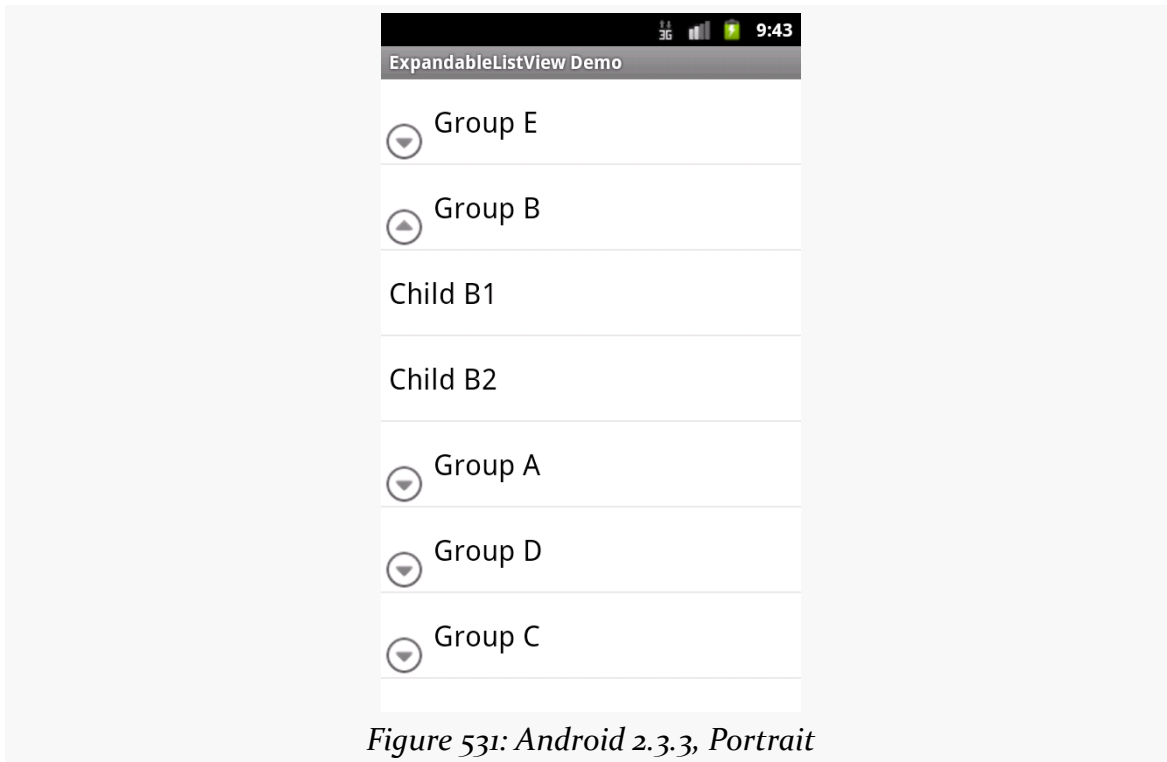
    return(model.getJSONArray(key));
}
}
```

This adapter wraps a `JSONObject` and assumes that the JSON structure is an object, keyed by strings, whose values are arrays of strings. The object returned by `getGroup()` is the key for that group's position; the object returned by `getChild()` is the string at that child's array index for it's group's array. Since the data structure is treated as immutable, and since there are no other better IDs in the data structure itself, the group ID is simply the group's position, and the child's ID is simply a mash-up of the group and child positions.

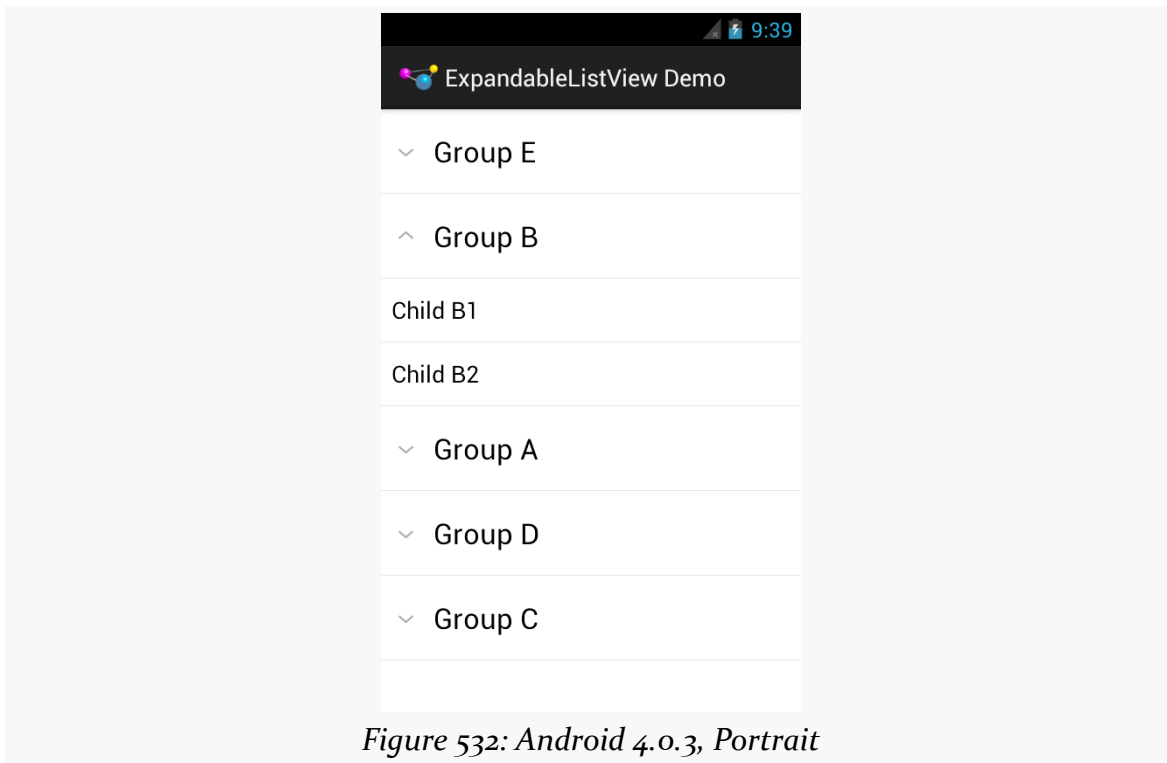


## Visual Representation

This is what an `ExpandableListView` looks like in a few different Android versions and configurations, based upon the sample app shown above.



*Figure 531: Android 2.3.3, Portrait*



*Figure 532: Android 4.0.3, Portrait*

Note that while the data in the JSON file has the groups sorted alphabetically, because `JSONObject` effectively loads its data into a `HashMap`, the sorting gets lost in the data model, which is why the groups appear out of order.

Also note that the visual representation of the “collapsed” and “expanded” states is controlled by the `ExpandableListAdapter` and the view used for the groups. In this sample, we use `android.R.layout.simple_expandable_list_item_1` for the groups, which gives us the caret designation for expanded versus collapsed states in 4.0.3 and the lower-left arrowhead-in-circle icon for 2.3.3. You can create your own rows with your own indicators as you see fit.



# Widget Catalog: SeekBar

---

SeekBar allows the user to choose a value along a continuous range by sliding a “thumb” along a horizontal line. In effect — and in practice, as it turns out — SeekBar is a user-modifiable ProgressBar.

## Key Usage Tips

The value range of a SeekBar runs from 0 to a developer-set maximum value. As with ProgressBar, the default maximum is 100, but that can be changed via an `android:max` attribute or the `setMax()` method. The minimum value is always 0, so if you want a range starting elsewhere, just add your starting value to the actual value (obtained via `getProgress()`) to slide the range as desired.

You can find out about changes in the SeekBar value by attaching an `OnSeekBarChangeListener` implementation. The primary method on that interface is `onProgressChanged()`, where you are notified about changes in the progress value (second parameter) and whether that change was initiated directly by the user interacting with the widget (third parameter). The interface also has `onStartTrackingTouch()` and `onStopTrackingTouch()`, to indicate when the user is attempting to change the position of the thumb via the touchscreen, though these methods are less-commonly used.

## A Sample Usage

The sample project can be found in [WidgetCatalog/SeekBar](#).

Layout:

## WIDGET CATALOG: SEEKBAR

---

```
<LinearLayout xmlns:android="http://schemas.android.com/apk/res/android"
    xmlns:tools="http://schemas.android.com/tools"
    android:layout_width="match_parent"
    android:layout_height="match_parent"
    android:gravity="center_vertical"
    tools:context=".MainActivity">

    <TextView
        android:id="@+id/value"
        android:layout_width="wrap_content"
        android:layout_height="wrap_content"
        android:text="0"
        android:ems="2"
        android:gravity="right|center_vertical"
        android:layout_marginRight="10dp"
        android:textAppearance="@android:style/TextAppearance.Large"/>

    <SeekBar
        android:id="@+id/seek_bar"
        android:layout_width="0dp"
        android:layout_height="wrap_content"
        android:layout_weight="1"
        android:layout_marginRight="10dp"
        android:max="50"/>

</LinearLayout>
```

Activity:

```
package com.commonware.android.wc.seekbar;

import android.app.Activity;
import android.os.Bundle;
import android.widget.SeekBar;
import android.widget.SeekBar.OnSeekBarChangeListener;
import android.widget.TextView;

public class MainActivity extends Activity implements
    OnSeekBarChangeListener {
    TextView value=null;

    @Override
    protected void onCreate(Bundle savedInstanceState) {
        super.onCreate(savedInstanceState);
        setContentView(R.layout.activity_main);

        value=(TextView)findViewById(R.id.value);

        SeekBar seekBar=(SeekBar)findViewById(R.id.seek_bar);

        seekBar.setOnSeekBarChangeListener(this);
    }
}
```

## WIDGET CATALOG: SEEKBAR

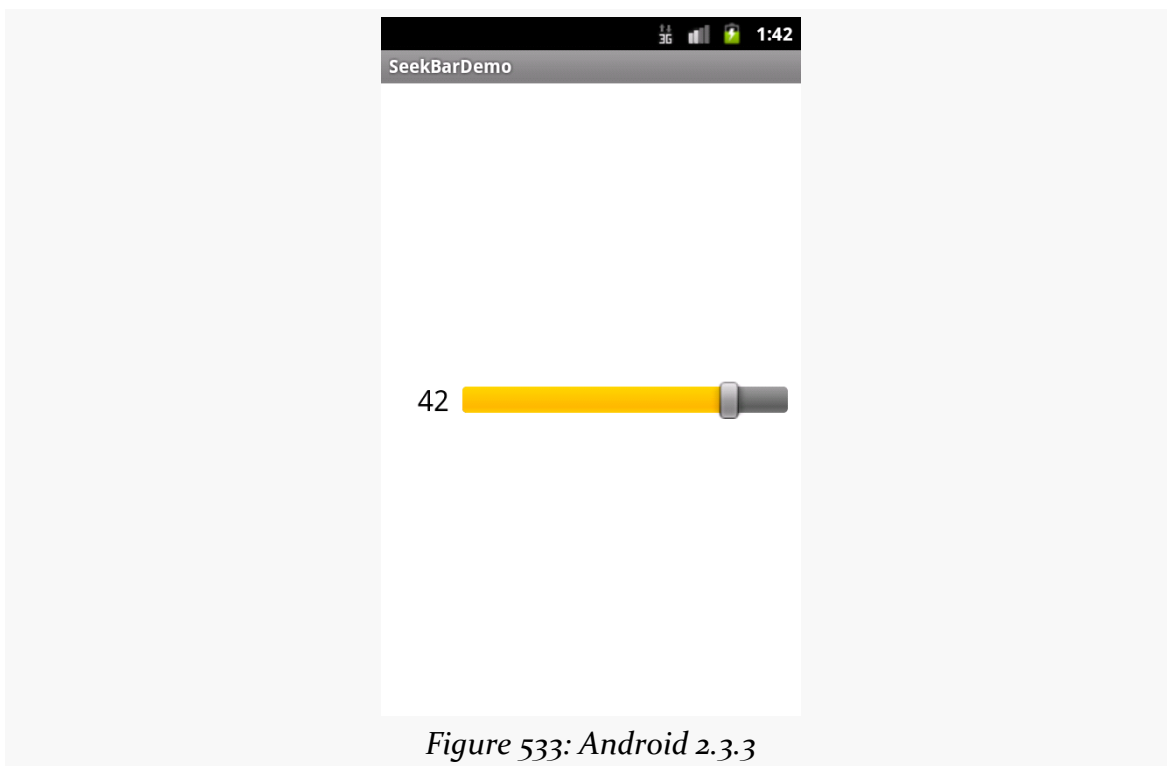
---

```
@Override
public void onProgressChanged(SeekBar seekBar, int progress,
    boolean fromUser) {
    value.setText(String.valueOf(progress));
}

@Override
public void onStartTrackingTouch(SeekBar seekBar) {
    // no-op
}

@Override
public void onStopTrackingTouch(SeekBar seekBar) {
    // no-op
}
}
```

## Visual Representation



*Figure 533: Android 2.3.3*

WIDGET CATALOG: SEEKBAR

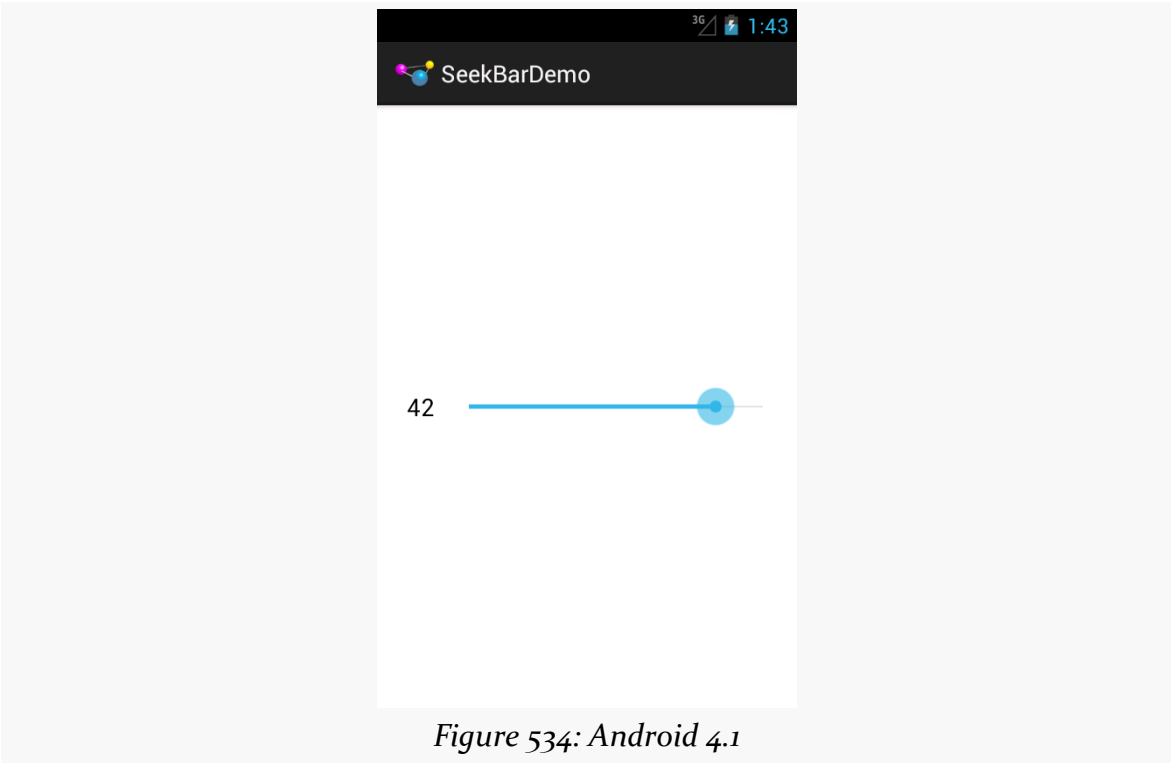


Figure 534: Android 4.1

# Widget Catalog: SlidingDrawer

---

Having some form of means of allowing the user to swipe to show more things is an important visual pattern. We saw this earlier in the book with [the ViewPager container](#). And there are other modern techniques for doing this that you will see in apps like Google+.

SlidingDrawer, while implementing a variation on this pattern, is a bit out of date at present. Mostly, that's a question of its UI: tapping a drawer "handle" to open it is not what you tend to see nowadays. That being said, it works perfectly well, wrapping around a container to make it appear or disappear based on user input, complete with a sliding animation effect.

Note that SlidingDrawer was deprecated in API Level 17 (a.k.a., Android 4.2). This means that Google is steering you in other directions, including forking [the AOSP code for SlidingDrawer](#) and maintaining it yourself. The [animator framework](#) offers other ways of implementing sliding widgets that may be better suited for your UI, anyway.

## Key Usage Tips

The SlidingDrawer itself is transparent, except for the button to trigger the slide and its accompanying horizontal bar. Hence, if you want the drawer contents to completely obscure what is outside of the drawer, you will need to use an appropriate background. Otherwise, the drawer contents and what lies outside the drawer will be alpha-blended based on their own translucency, as is seen in [the screenshots later in this chapter](#).



The `SlidingDrawer` can be horizontal or vertical; it is vertical by default. However, it only slides one way (bottom-to-top for vertical, right-to-left for horizontal). There is no way to reverse the direction of the sliding effect.

You must supply `android:content` and `android:handle` attributes in `SlidingDrawer`, containing references to the widget that forms the content of the drawer and the drawer's handle, respectively. Typically, the drawer's handle is an `ImageView`. Note that you *must* supply a handle — you cannot skip either of these attributes.

## A Sample Usage

The sample project can be found in [WidgetCatalog/SlidingDrawer](#).

Layout:

```
<?xml version="1.0" encoding="utf-8"?>
<RelativeLayout xmlns:android="http://schemas.android.com/apk/res/android"
    android:layout_width="fill_parent"
    android:layout_height="fill_parent">

    <Button
        android:layout_width="fill_parent"
        android:layout_height="fill_parent"
        android:text="@string/drawer_closed"/>

    <SlidingDrawer
        android:id="@+id/drawer"
        android:layout_width="fill_parent"
        android:layout_height="fill_parent"
        android:content="@+id/content"
        android:handle="@+id/handle">

        <ImageView
            android:id="@id/handle"
            android:layout_width="wrap_content"
            android:layout_height="wrap_content"
            android:src="@drawable/tray_handle_normal"/>

        <Button
            android:id="@id/content"
            android:layout_width="fill_parent"
            android:layout_height="fill_parent"
            android:text="@string/drawer_msg"/>
    </SlidingDrawer>
</RelativeLayout>
```

Activity:

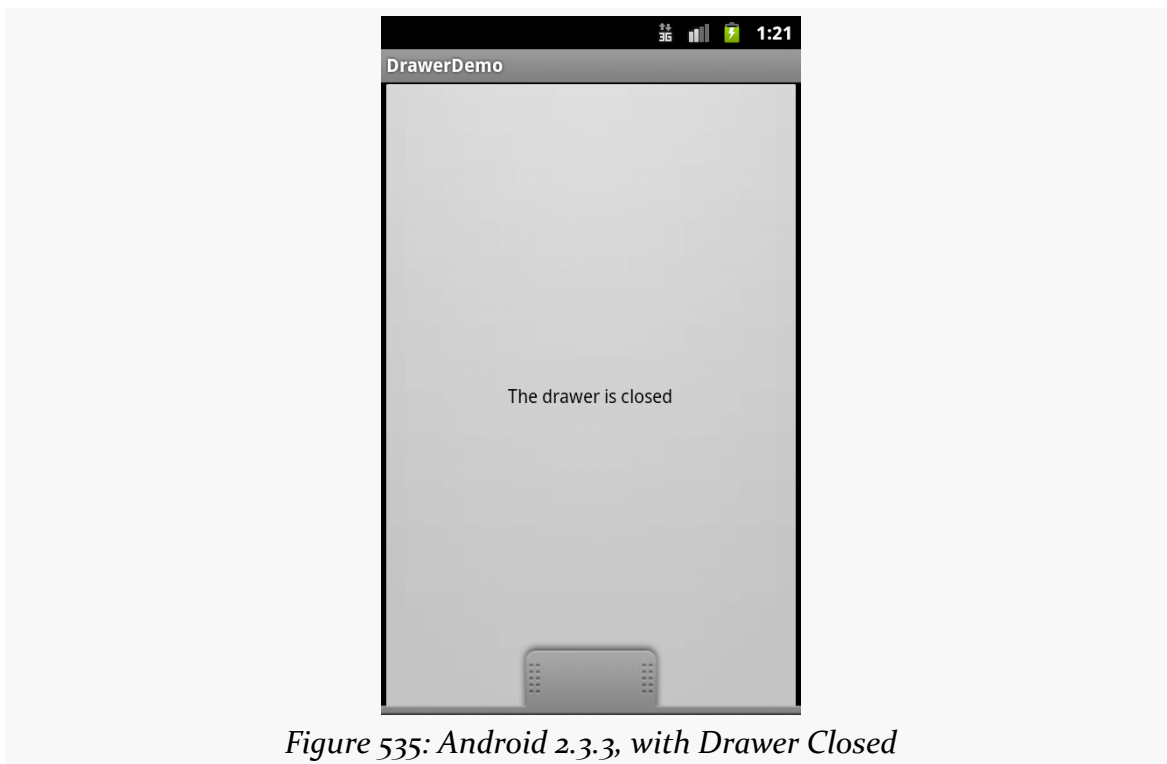
```
package com.commonware.android.drawer;

import android.app.Activity;
import android.os.Bundle;

public class DrawerDemo extends Activity
{
    /** Called when the activity is first created. */
    @Override
    public void onCreate(Bundle savedInstanceState)
    {
        super.onCreate(savedInstanceState);
        setContentView(R.layout.main);
    }
}
```

## Visual Representation

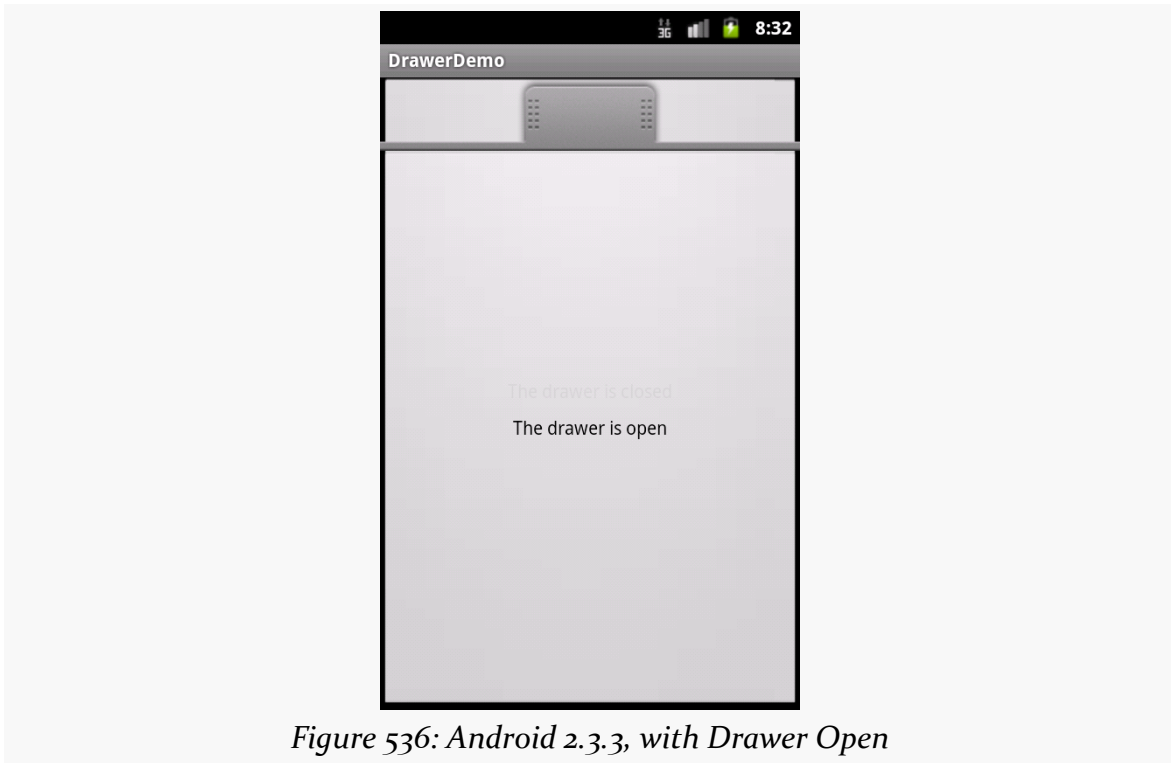
This is what a SlidingDrawer looks like in a few different Android versions and configurations, based upon the sample app shown above.



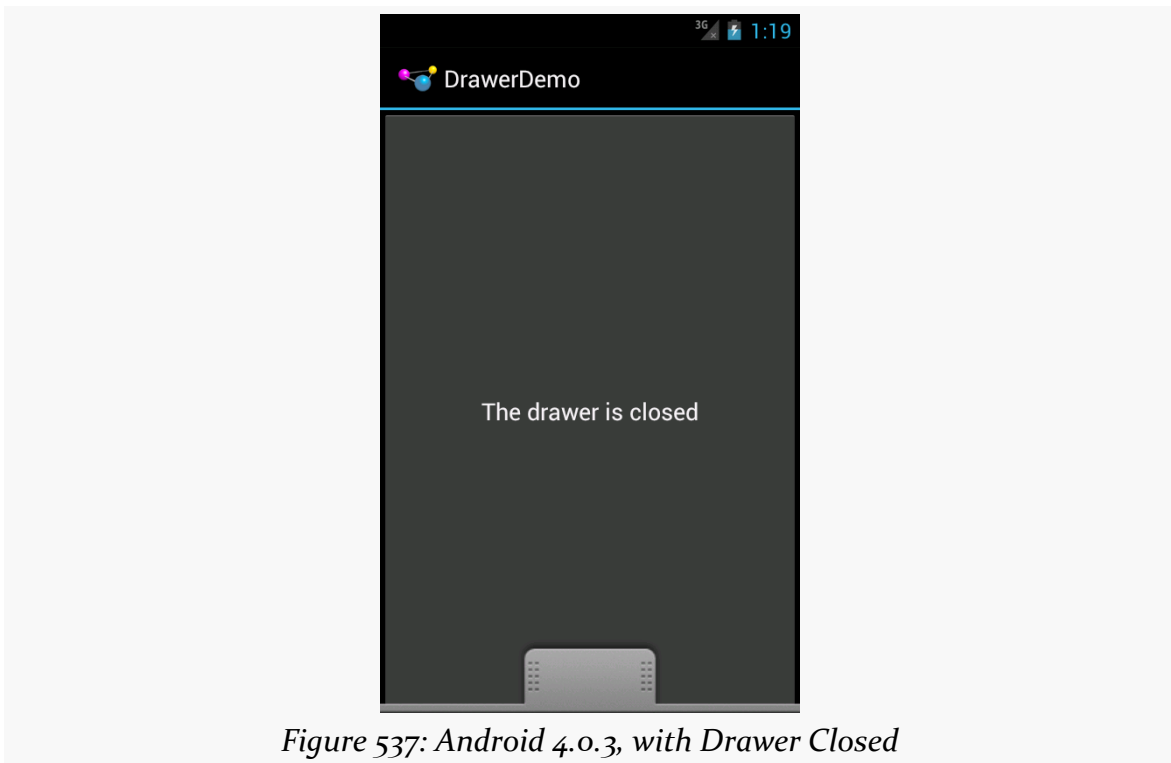
*Figure 535: Android 2.3.3, with Drawer Closed*

## WIDGET CATALOG: SLIDINGDRAWER

---



*Figure 536: Android 2.3.3, with Drawer Open*



*Figure 537: Android 4.0.3, with Drawer Closed*

# Widget Catalog: StackView

---

StackView is an AdapterView. Whereas ListView uses a horizontal scrolling list as its UI metaphor, StackView uses a stack of cards as its metaphor. Just as ListView shows a handful of rows, StackView shows a handful of cards. These cards can be swiped away via a swipe towards the southwest corner of the screen. The top card is fully visible; the edges of a few other cards can be seen but are otherwise obscured by cards “higher in the stack”.

While certainly usable in activities and fragments, StackView was introduced in support of app widgets. App widgets like bookmarks, Google Books covers, and the like use StackView to show an item and allow users to navigate to the rest of the items by flipping these virtual cards.

## Key Usage Tips

Generally speaking, working with StackView is not significantly different than is working with any other AdapterView. You create an Adapter defining the contents (in this case, defining the cards), you attach the Adapter to the StackView, and put the StackView somewhere on the screen.

As the cards overlap, however, transparency becomes an issue. If the top card is not completely opaque, you will see the card beneath it “peeking through” as its contents are blended in via the alpha channel. In some cases, this is a perfectly desirable outcome. However, if that is not what you want, make sure that the backgrounds of your overall container for the card’s contents (e.g., a RelativeLayout) has an opaque background, such as a color with FF for the alpha value.

Also, since the objective is to have the children be visually stacked, the children cannot be the size of the StackView itself (e.g., the children cannot use `match_parent` or `fill_parent` for a dimension). StackView seems to work best with children that have explicit sizes (e.g., values in dp).

## A Sample Usage

The sample project can be found in [WidgetCatalog/StackView](#).

Activity Layout:

```
<?xml version="1.0" encoding="utf-8"?>
<StackView xmlns:android="http://schemas.android.com/apk/res/android"
    android:id="@+id/details"
    android:layout_width="fill_parent"
    android:layout_height="fill_parent"/>
```

Item Layout:

```
<TextView xmlns:android="http://schemas.android.com/apk/res/android"
    android:layout_width="200dp"
    android:layout_height="200dp"
    android:background="#FFFF0000"
    android:gravity="center"
    android:textAppearance="?android:attr/textAppearanceLarge"/>
```

Activity:

```
package com.commonware.android.wc.stack;

import android.app.Activity;
import android.content.Context;
import android.os.Bundle;
import android.view.View;
import android.view.ViewGroup;
import android.widget.AdapterView;
import android.widget.StackView;

public class MainActivity extends Activity {
    static String[] items= { "lorem", "ipsum", "dolor", "sit", "amet",
        "consectetuer", "adipiscing", "elit", "morbi", "vel", "ligula",
        "vitae", "arcu", "aliquet", "mollis", "etiam", "vel", "erat",
        "placerat", "ante", "porttitor", "sodales", "pellentesque",
        "augue", "purus" };
    StackView stack;

    @Override
    public void onCreate(Bundle icle) {
```

## WIDGET CATALOG: STACKVIEW

---

```
super.onCreate( savedInstanceState );
setContentView( R.layout.main );

stack=(StackView)findViewById( R.id.details );
stack.setAdapter( new ItemAdapter( this, R.layout.item, items ) );
}

private static class ItemAdapter extends ArrayAdapter<String> {
    public ItemAdapter( Context context, int textViewResourceId,
        String[] objects ) {
        super( context, textViewResourceId, objects );
    }

    @Override
    public View getView( int position, View convertView, ViewGroup parent ) {
        View result=super.getView( position, convertView, parent );

        result.setBackgroundColor( 0xFF330000 + ( position * 0x0A0A ) );

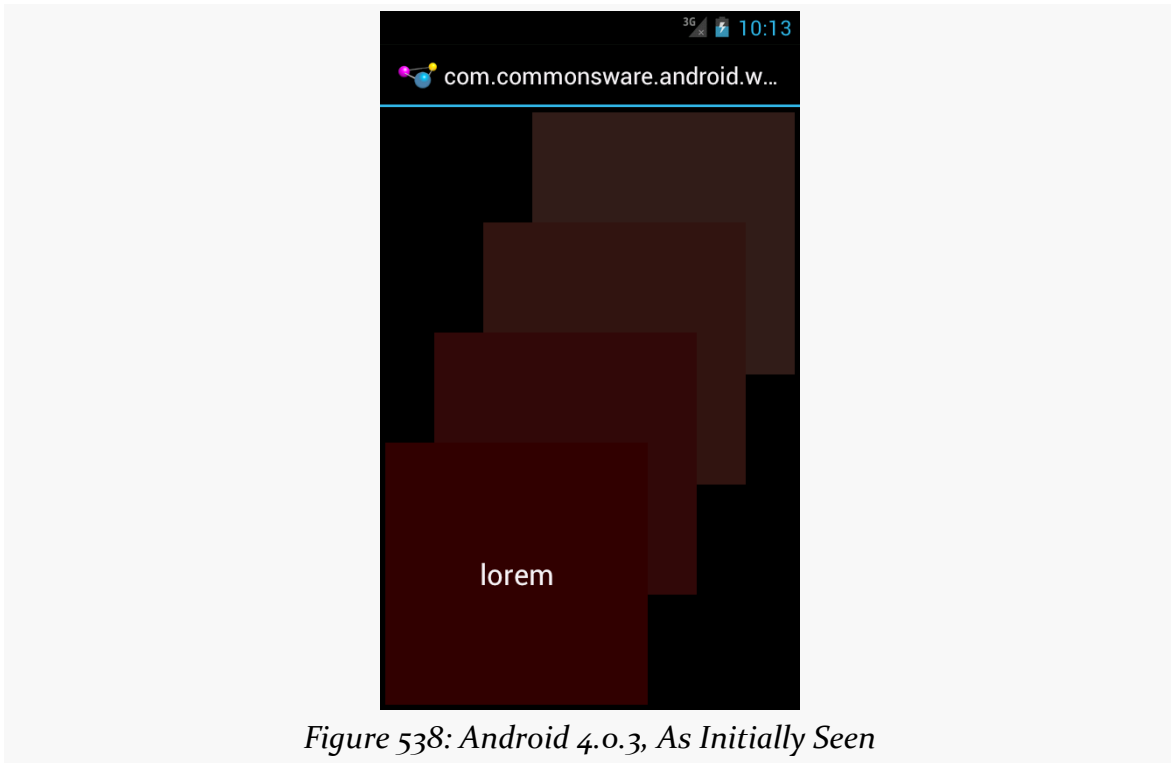
        return( result );
    }
}
}
```

## Visual Representation

This is what a StackView looks like in Android 4.0.3, based upon the sample app shown above:

## WIDGET CATALOG: STACKVIEW

---



# Widget Catalog: TabHost and TabWidget

---

Before we had the action bar and `ViewPager`, we had `TabHost` and `TabWidget` as our means of displaying tabs. Nowadays, in most cases, using [tabs in the action bar](#) would be preferable, or perhaps using [“swipecy tabs” with ViewPager](#). However, there may be cases where the classic tabs are a better solution, or you may have inherited legacy code that still uses `TabHost`.

## Deprecation Notes

Just as `ListActivity` helps one use a `ListView`, `TabActivity` helps one use a `TabHost`. However, `TabActivity` is marked as deprecated. That is largely because its parent class, `ActivityGroup`, is deprecated. While you can still use `TabActivity`, it is no longer recommended. It also is not necessary, as there are ways to use `TabHost` and `TabWidget` without using `TabActivity`, as will be demonstrated later in this chapter.

## Key Usage Tips

There are a few widgets and containers you need to use in order to set up a tabbed portion of a view:

- `TabHost` is the overarching container for the tab buttons and tab contents
- `TabWidget` implements the row of tab buttons, which contain text labels and optionally contain icons
- `FrameLayout` is the container for the tab contents; each tab content is a child of the `FrameLayout`



You load contents into that `FrameLayout` in one of two ways:

1. You can define the contents simply as child widgets (or containers) of the `FrameLayout` in a layout XML file you are using for the whole tab setup
2. You can define the contents at runtime

Curiously, you do not define what goes in the tabs themselves, or how they tie to the content, in the layout XML file. Instead, you must do that in Java, by creating a series of `TabSpec` objects (obtained via `newTabSpec()` on `TabHost`), configuring them, then adding them in sequence to the `TabHost` via `addTab()`.

The two key methods on `TabSpec` are:

- `setContent()`, where you indicate what goes in the tab content for this tab, typically the `android:id` of the view you want shown when this tab is selected
- `setIndicator()`, where you provide the caption for the tab button and, in some flavors of this method, supply a `Drawable` to represent the icon for the tab

Note that tab “indicators” can actually be views in their own right, if you need more control than a simple label and optional icon.

Also note that you must call `setup()` on the `TabHost` before configuring any of these `TabSpec` objects. The call to `setup()` is not needed if you are using the `TabActivity` base class for your activity.

## A Sample Usage

The sample project can be found in [WidgetCatalog/Tab](#).

Layout:

```
<?xml version="1.0" encoding="utf-8"?>
<TabHost xmlns:android="http://schemas.android.com/apk/res/android"
    android:id="@+id/tabhost"
    android:layout_width="fill_parent"
    android:layout_height="fill_parent">
    <LinearLayout
        android:orientation="vertical"
        android:layout_width="fill_parent"
        android:layout_height="fill_parent">
        <TabWidget android:id="@android:id/tabs"
```

## WIDGET CATALOG: TABHOST AND TABWIDGET

---

```
        android:layout_width="fill_parent"
        android:layout_height="wrap_content"
    />
    <FrameLayout android:id="@android:id/tabcontent"
        android:layout_width="fill_parent"
        android:layout_height="fill_parent">
        <AnalogClock android:id="@+id/tab1"
            android:layout_width="fill_parent"
            android:layout_height="fill_parent"
        />
        <Button android:id="@+id/tab2"
            android:layout_width="fill_parent"
            android:layout_height="fill_parent"
            android:text="A semi-random button"
        />
    </FrameLayout>
</LinearLayout>
</TabHost>
```

Activity:

```
package com.commonsware.android.tabhost;

import android.app.Activity;
import android.os.Bundle;
import android.widget.TabHost;

public class TabDemo extends Activity {
    @Override
    public void onCreate(Bundle icle) {
        super.onCreate(icle);
        setContentView(R.layout.main);

        TabHost tabs=(TabHost)findViewById(R.id.tabhost);

        tabs.setup();

        TabHost.TabSpec spec=tabs.newTabSpec("tag1");

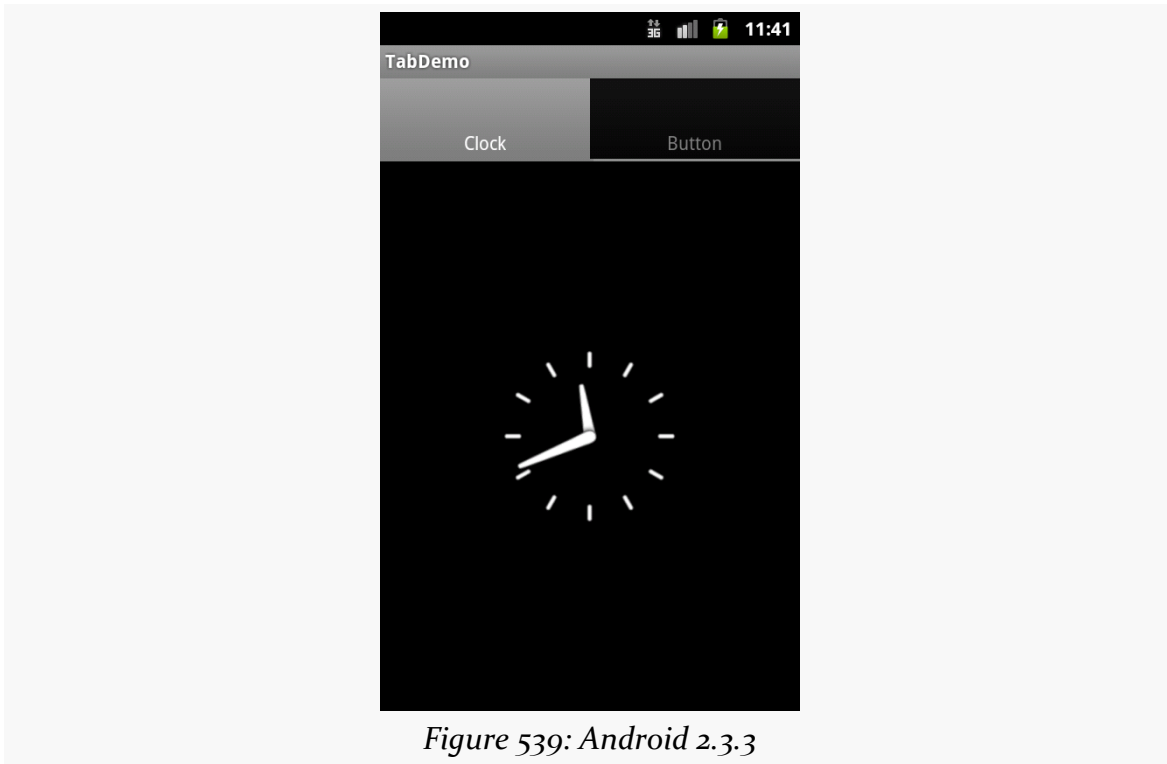
        spec.setContent(R.id.tab1);
        spec.setIndicator("Clock");
        tabs.addTab(spec);

        spec=tabs.newTabSpec("tag2");
        spec.setContent(R.id.tab2);
        spec.setIndicator("Button");
        tabs.addTab(spec);
    }
}
```

Note that ordinarily you would use icons with your tabs, and so the second parameter to `setIndicator()` would be a reference to a drawable resource. This particular sample skips the icons.

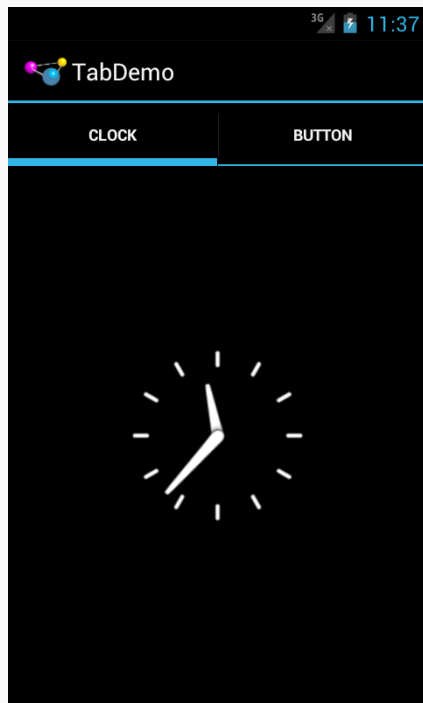
### Visual Representation

This is what a `TabHost` and `TabWidget` look like in a few different Android versions and configurations, based upon the sample app shown above.



## WIDGET CATALOG: TABHOST AND TABWIDGET

---



*Figure 540: Android 4.0.3*



# Widget Catalog: TimePicker

---

Just as [DatePicker](#) allows the user to pick a date, TimePicker allows the user to pick a time. This widget is a bit simpler to use, insofar as you do not have the option of the integrated CalendarView as you do with DatePicker. In other respects, TimePicker follows the patterns established by DatePicker.

Note that TimePicker only supports hours and minutes, not seconds or finer granularity.

## Key Usage Tips

With DatePicker, the act of supplying an `OnDateSetListener` also required you to supply the year/month/day to use as a starting point. TimePicker is more intelligently designed: setting the `OnTimeSetListener` is independent from adjusting the hour or minute.

As with DatePicker, TimePicker works well with Calendar and GregorianCalendar, in terms of setting and getting the hour/minute/second from the TimePicker and converting it into something you can use in your code.

There is [a bug in Android 4.0/4.0.3](#) in which your `OnTimeSetListener` is not invoked when the user changes between AM and PM when viewing the TimePicker in 12-hour display mode.

## A Sample Usage

The sample project can be found in [WidgetCatalog/TimePicker](#).

## WIDGET CATALOG: TIMEPICKER

---

### Layout:

```
<?xml version="1.0" encoding="utf-8"?>
<LinearLayout xmlns:android="http://schemas.android.com/apk/res/android"
    android:layout_width="fill_parent"
    android:layout_height="fill_parent"
    android:orientation="vertical"
    android:gravity="center_vertical">

    <TimePicker
        android:id="@+id/picker"
        android:layout_width="fill_parent"
        android:layout_height="wrap_content"/>

</LinearLayout>
```

### Activity:

```
package com.commonware.android.wc.timepick;

import android.app.Activity;
import android.os.Bundle;
import android.widget.TimePicker;
import android.widget.TimePicker.OnTimeChangedListener;
import android.widget.Toast;
import java.util.Calendar;

public class TimePickerDemoActivity extends Activity implements
    OnTimeChangedListener {
    @Override
    public void onCreate(Bundle savedInstanceState) {
        super.onCreate(savedInstanceState);
        setContentView(R.layout.main);

        TimePicker picker=(TimePicker)findViewById(R.id.picker);

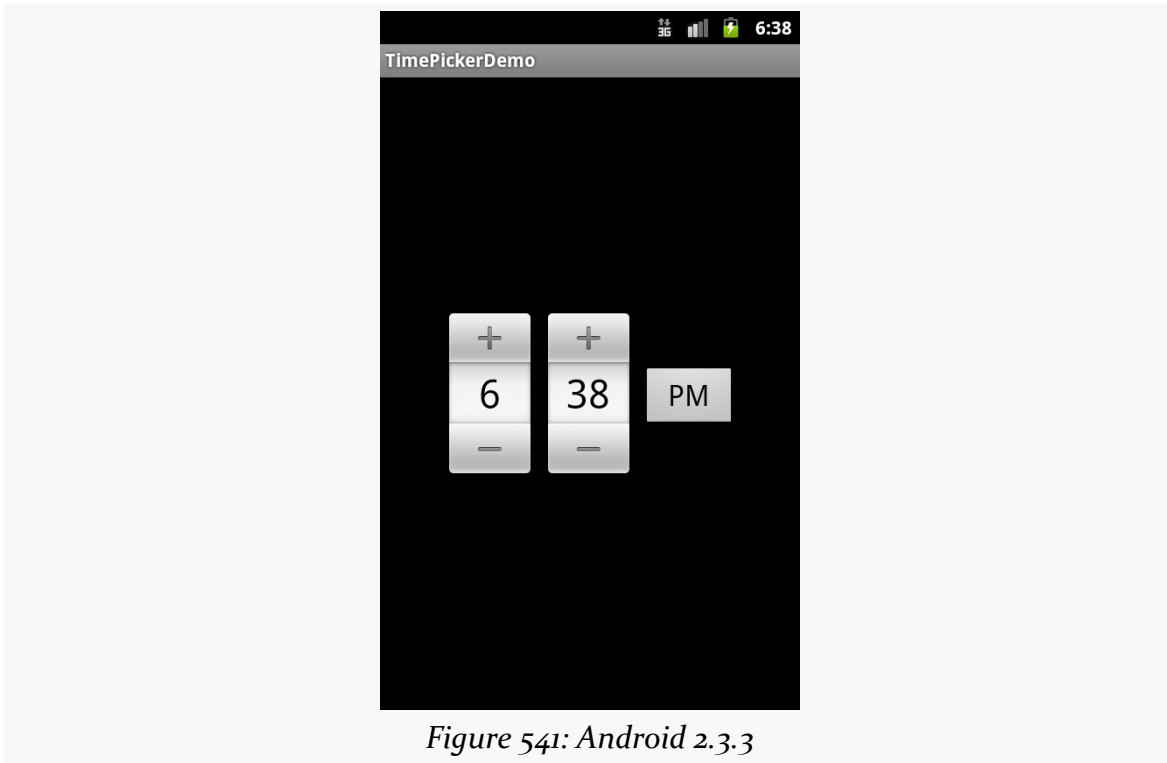
        picker.setOnTimeChangedListener(this);
    }

    @Override
    public void onTimeChanged(TimePicker view, int hourOfDay, int minute) {
        Calendar then=Calendar.getInstance();

        then.set(Calendar.HOUR_OF_DAY, hourOfDay);
        then.set(Calendar.MINUTE, minute);
        then.set(Calendar.SECOND, 0);

        Toast.makeText(this, then.getTime().toString(), Toast.LENGTH_SHORT)
            .show();
    }
}
```

## Visual Representation

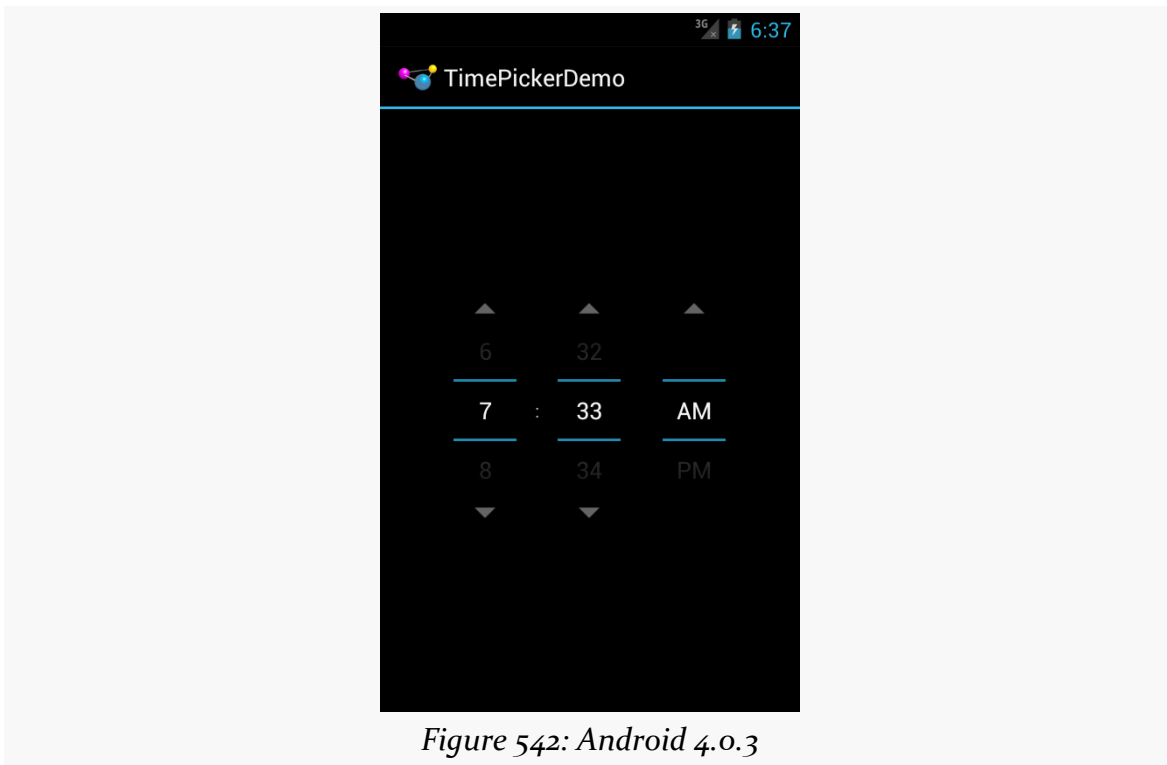


*Figure 541: Android 2.3.3*



## WIDGET CATALOG: TIMEPICKER

---



# Widget Catalog: ViewFlipper

---

A ViewFlipper behaves a bit like a FrameLayout that is set up such that only one child can be visible at a time. You can control which of those children is visible, either by index or via `showNext()`/`showPrevious()` methods to rotate between them.

You can also set up [animated effects](#) to control how a child leaves and the next one enters, such as applying a sliding effect.

And, you can set up ViewFlipper to automatically flip between children on a specified period, without further developer involvement. This, coupled with the animation, can be used for news tickers, ad banner rotations, or the like where light animations (e.g., fade out and fade in) can be used positively.

## Key Usage Tips

ViewFlipper can have as many children as needed (within memory constraints), though you will want at least two for it to be meaningful.

By default, the transition between children is an immediate “smash cut” — the old one vanishes and the new one appears instantaneously. You can call `setInAnimation()` and/or `setOutAnimation()` to supply [an Animation object or resource](#) to use for the transitions instead.

By default, the ViewFlipper will show its first child and stay there. You can manually flip children via `showNext()`, `showPrevious()`, and `setDisplayChild()`, the latter of which taking a position index of which child to display. You can also have automatic flipping, by one of two means:

1. In your layout, `android:flipInterval` will set up the amount of time to display each child before moving to the next, and `android:autoStart` will indicate if the automated flipping should begin immediately or not
2. In Java, `setFlipInterval()` serves the same role as `android:flipInterval`, and you can control when flipping is enabled via `startFlipping()` and `stopFlipping()`

## A Sample Usage

The sample project can be found in [WidgetCatalog/ViewFlipper](#).

Layout:

```
<?xml version="1.0" encoding="utf-8"?>
<LinearLayout xmlns:android="http://schemas.android.com/apk/res/android"
    android:orientation="vertical"
    android:layout_width="fill_parent"
    android:layout_height="fill_parent"
    >
    <ViewFlipper android:id="@+id/details"
        android:layout_width="fill_parent"
        android:layout_height="fill_parent"
        >
    </ViewFlipper>
</LinearLayout>
```

Activity:

```
package com.commonsware.android.flipper2;

import android.app.Activity;
import android.os.Bundle;
import android.view.ViewGroup;
import android.widget.Button;
import android.widget.ViewFlipper;

public class FlipperDemo2 extends Activity {
    static String[] items={"lorem", "ipsum", "dolor", "sit", "amet",
        "consectetuer", "adipiscing", "elit",
        "morbi", "vel", "ligula", "vitae",
        "arcu", "aliquet", "mollis", "etiam",
        "vel", "erat", "placerat", "ante",
        "porttitor", "sodales", "pellentesque",
        "augue", "purus"};

    ViewFlipper flipper;

    @Override
    public void onCreate(Bundle icle) {
```

```
super.onCreate(ifecycle);
setContentViews(R.layout.main);

flipper=(ViewFlipper)findViewById(R.id.details);

for (String item : items) {
    Button btn=new Button(this);

    btn.setText(item);

    flipper.addView(btn,
        new ViewGroup.LayoutParams(
            ViewGroup.LayoutParams.FILL_PARENT,
            ViewGroup.LayoutParams.FILL_PARENT));
}

flipper.setFlipInterval(2000);
flipper.startFlipping();
}
```

## Visual Representation

There is no visual representation of a ViewFlipper itself, as it renders no pixels on its own. Rather, it simply shows the current child.



# Device Catalog: Google TV

---

As Android increases in popularity, we are seeing a few devices (or device categories) that become popular but are outside the mainstream, defined here as phones and tablets that legitimately have the Play Store on them. Of course, there are lots of devices that fall outside the mainstream that are not popular — most likely, you do not care about these unless you have a specific need to have your app run on one (e.g., particular device bought by your firm for its field staff). But the devices profiled in this part of the book are popular enough that you might want to consider addressing them, despite the additional “fragmentation” they introduce.

The first such device category is Google TV. At the time of this writing, it has been about 18 months since Google TV was announced (at the 2010 Google I/O conference) and over a year since devices started shipping. However, only recently have we been able to create apps for Google TV devices, let alone users be able to install them. This chapter outlines what you will need to consider if you want your apps to be on Google TV... or perhaps if you do not want your apps to be on Google TV.

At the time of this writing, Google TV runs Android 3.1. Hence, it supports things like fragments natively, without necessarily having the need for the Android Support package. Of course, you may be using the Android Support package for other devices (e.g., Android 2.x phones), and that works perfectly fine on Google TV.

## Prerequisites

Understanding this chapter requires that you have read the core chapters of this book.

## What Features and Configurations Does It Use?

Android has built into the SDK a fair bit of device flexibility. Most of this comes in the form of configurations (things that affect resources) and features (other stuff). If your application can handle a range of configurations and features, or can advertise that they need certain configurations or features, they can handle Google TV or arrange to not be available for Google TV on the Market.

### Screen Size and Density

Google TV devices are always categorized as large screen size. Hence, you will tend to put your layouts in `res/layout-large/`, or possibly `res/layout-large-land/` (since Google TV presumably will always consider itself to be landscape).

Densities, however, are a bit more complicated.

Google TV is for use with HDTV, whether Google TV is integrated into the television or it comes as an external set-top box. There are two predominant HDTV resolutions, known as 720p (1280x720) and 1080p (1920x1080). A 1080p television will be categorized as an `xhdpi` density device. A 720p television will be categorized as a `tvdpi` device, where `tvdpi` was a new resource set qualifier added in API Level 13. `tvdpi` is for devices around 213dpi, in between `mdpi` and `hdpi`. In practice, you might elect to skip `tvdpi` for your drawable resources, allowing Android to resample your `mdpi`, `hdpi`, or `xhdpi` drawables as needed.

### Input Devices

Google TV is not considered to be a touchscreen device. As such, from a resource standpoint, you can use `-notouch` to isolate resources that should be used on Google TV (or, potentially, other future non-touchscreen devices, should they arise). Hence, if you want a different UI for Google TV than a tablet — to address navigational differences, for example — you can use `res/layout-large-land-notouch` for Google TV and `res/layout-large/` and `res/layout-large-land/` for other types of large-screen devices.

### Other Hardware

Google TV has no sensors, no camera, no Bluetooth, no microphone, and no telephony features. As such, any application requiring such features will not run on Google TV and will not even show up in the Play Store for such devices. [The Google](#)

[TV developer documentation](#) has the roster of specific <uses-feature> names that must not be referenced.

Bear in mind that some of these will be driven by permissions. If you ask for the SEND\_SMS permission, Android will assume you need android.hardware.telephony unless you specifically state otherwise, via a <uses-feature> element for android.hardware.telephony with android:required="false".

## What Is Really Different?

Beyond the features and configurations, there are other things about Google TV that will depart from what you might expect for an Android environment, due to the nature of the TV set-top box platform and the Android implementation upon it.

### The Emulator

The Google TV add-on for the Android SDK offers an emulator. However, it does not work like the emulator for standard Android. Instead of using a qemu-based emulator, the Google TV emulator uses KVM, a virtualization environment used by Linux servers. While you can get KVM to run on a Linux desktop — perhaps with some tweaking — it is not available for Windows or OS X development machines. Moreover, KVM cannot itself run in a virtualized environment, so you cannot use VirtualBox or similar solutions to have a Windows or OS X machine run a copy of Linux that, in turn, would run a copy of the Google TV emulator.

For Linux developers, the headaches are modest. For Windows and OS X developers, the options are far from ideal:

1. Use a spare PC that you happen to have lying around for a Linux environment, bearing in mind that not all CPUs and BIOSes support the virtualization extensions required by KVM
2. Attempt to create a bootable USB key that contains Linux and the Android SDK with the emulator, so you can test your app on your existing PC
3. Buy a Google TV device and test exclusively on hardware (downside: unless you have two televisions, you will not be able to test both 720p and 1080p display sizes)
4. Switch to Linux for your development needs



### CPU and NDK

Google TV devices will be built on both ARM and Intel chipsets. The devices that shipped in 2010 and most of 2011 were based on Intel Atom chips, but future Google TV devices may use ARM as well.

This should not matter much for you right now, simply because you cannot use the Native Development Kit (NDK) with Google TV at this time. With luck, support for this will be added in the not-too-distant future, particularly for game development.

### Overscan

Television standards have been with us for several decades. Television sets from the dawn of television had significantly lower and more variable quality than today's devices. The delivery of the signal at the outset had significantly lower and more variable quality than today's over-the-air HDTV or cable connections. As a result of these two characteristics, the engineers devising television standards made some decisions that, while necessary at the time, add some complexity to delivering apps to televisions, in the form of overscan.

Simply put, not all televisions show exactly the same picture. Depending on device and signal, a television may show up to 12% less of the picture, as measured horizontally and vertically. Hence, the theoretical ideal screen size (e.g., 720p = 1280 x 720 pixels) may be achieved in some cases, but you may get less (e.g., 1128 x 634 pixels) in other cases.

Google TV, as part of setup, will determine the safe viewing size for the television, by having the user calibrate the device based on test images. Hence, Google TV will not attempt to display something that the television is incapable of displaying (assuming proper setup). However, this does mean that while you will be thinking of 720p or 1080p resolution, you may not get all that space, and so you need to design your app to accommodate this.

One common problem encountered here is a background image. Developers have already been schooled to avoid full-screen backgrounds due to the wide range of resolutions available on handheld Android devices. Google TV just adds to the mix, where there are thousands upon thousands of possible actual resolutions, all minute changes from one another based upon what a particular television can handle. You will need to take this into account (e.g., put the background image on top of a solid field of color, where that solid color matches the dominant color from the edges of

the image, then keep the background image at a fixed resolution and allow the solid fills on the edges take care of the overscan area).

### Ethernet

While Google TV devices will generally be connected to the Internet, it may not be via WiFi. Since Google TV devices generally are not portable, some will have Ethernet jacks, and hence some users will elect to wire in their Google TV as opposed to using WiFi.

The upshot is that you should not assume that `WifiManager` will necessarily give you useful results. Also, `ConnectivityManager` should report wired Ethernet as `TYPE_ETHERNET`, added in API Level 13, when you call methods like `getActiveNetworkInfo()`.

### Location

Generally speaking, Google TV devices will tend not to move, earthquakes and large dogs notwithstanding.

As such, Google TV devices do not have GPS receivers. Rather, location is determined in an approximate fashion via address-based lookups, using a postal code. Hence, asking Android for a GPS fix on a Google TV device will be ineffective.

You can get the approximate location of a Google TV device by using the "static" location provider (e.g., `getLastKnownLocation("static")`). Unfortunately, there is no SDK-defined static data member for "static" at this time.

However, since users of Google TV devices tend not to be moving much at the time, it is a bit more likely than normal that they will want information about some location other than where they are. If your app is exclusively tied to providing information about their current location, you may wish to consider how you could extend your app to help users get information about other places that they may be interested in.

### Media Keys

Handheld Android devices have few buttons, with the number of buttons decreasing as time goes along. The only ones related to media are volume rockers, and perhaps a CAMERA button.

Google TV devices will be manipulated by remote controls. Many of these remotes will have lots and lots of buttons, akin to the remotes people are already used to. In addition to perhaps having a QWERTY keyboard, these remotes will have media-specific buttons for play, pause, etc.

The `KeyEvent` class has had support for some media buttons since API Level 3, mostly for use with wired headsets. API Level 11 added a bunch more media buttons. Your Google TV application may wish to respond to these, via `onKeyDown()` in a `View` or `Activity`. In particular, a Google TV application should not be using on-screen controls for play, pause, etc., as they take up screen space that probably could be put to better use. Rather, use layouts that offer such controls for touchscreen devices (e.g., phones and tablets) but rely on the media buttons for non-touchscreen devices.

### Channels and Listings

Unlike most handheld Android devices, Google TV is optimized to accompany some sort of television signal, whether that be cable, satellite, over-the-air HDTV, or something else. Not surprisingly, Google TV offers some TV-specific capabilities that you can elect to employ if it makes sense for your app.

Google TV has a `ContentProvider` for the device's channel lineup, so you can present a list of the available channels in a `ListView`, `Spinner`, etc. You can query on `content://com.google.android.tv.provider/channel_listing` and get back columns like the `channel_name` and `channel_number`. Note that you will need to hold the `com.google.android.tv.permission.READ_CHANNELS` permission for this to work.

Another column you can retrieve from the `ContentProvider` is `channel_uri`. This is a `Uri` within that `ContentProvider`, representing a specific channel. You can create an `ACTION_VIEW` `Intent` on that `Uri` and call `startActivity()` on it to switch to live TV and change the channel to that channel. This requires sufficient integration between the user's Google TV device and the source of the signal (e.g., using an "IR blaster" to control an external cable box to change channels), and so this may not work for all users.

### User Base

As Android has evolved, so has the way its devices get used. Phones are still frequently considered to be very personal, private devices. However, tablets are

becoming more shared — witness the XOOM Family Edition from Motorola Mobility. Televisions, of course, are also usually shared among household members. However, Android does not have a system-wide concept of separate user environments, though there are some enterprise add-ons that are making inroads in this area.

Depending on the nature of your app, you may wish to consider setting up your own concept of separate “accounts” for different users of the same device, so they can keep their content and settings separate. If needed, you might consider adding authentication of one form or another, to minimize the odds of one person getting into another person’s stuff.

## Getting Your Development Environment Established

If you want to develop for Google TV, you will need to do a bit of work to extend your development environment, as is outlined in this section.

### Installing the SDK Add-On

In the Android SDK Manager, in the “Android 3.1 (API 12)” section, you will find a “Google TV Addon by Google Inc.” entry, which you will need to install:

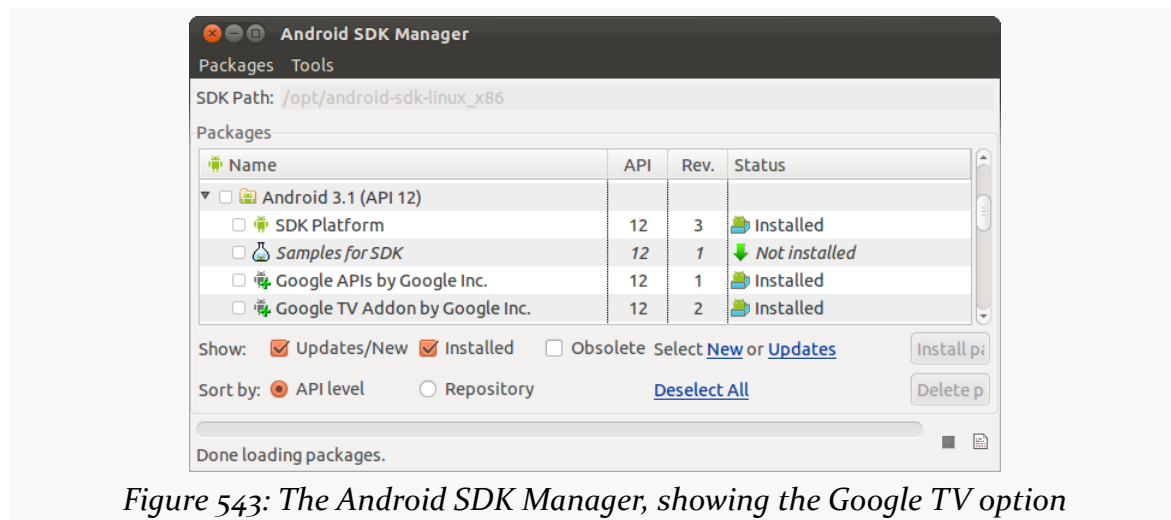


Figure 543: The Android SDK Manager, showing the Google TV option

## Getting KVM Set Up

Details of installing KVM will vary by Linux distro. For example, to install KVM on Ubuntu 10.04 or later, you would need to install a few packages:

```
sudo apt-get install qemu-kvm libvirt-bin bridge-utils
```

You will also need to log out and log back in, so a change in your account's group membership takes effect.

Full Ubuntu KVM installation instructions can be found on [the Ubuntu Web site](#) — similar instructions are (hopefully) available for whatever distro you are running.

Note that tools related to managing KVM virtual machines (e.g., Ubuntu's `ubuntu-vm-builder` and `virt-viewer` packages) may not be needed, as the Android SDK will be creating your virtual machines for you.

## Creating the Emulator

You will want to create four emulator images. Both should specify "Google TV Addon (Google Inc.) - API Level 12" as the target. The difference between the four will be their skins, dictating their resolutions:

1. 1080p
2. 1080p-overscan (which simulates the loss of available pixels due to overscan effects)
3. 720p
4. 720p-overscan

The rest of the setup should be as normal for your preferred emulator options (e.g., an SD card sufficiently large to hold any test media for external storage).

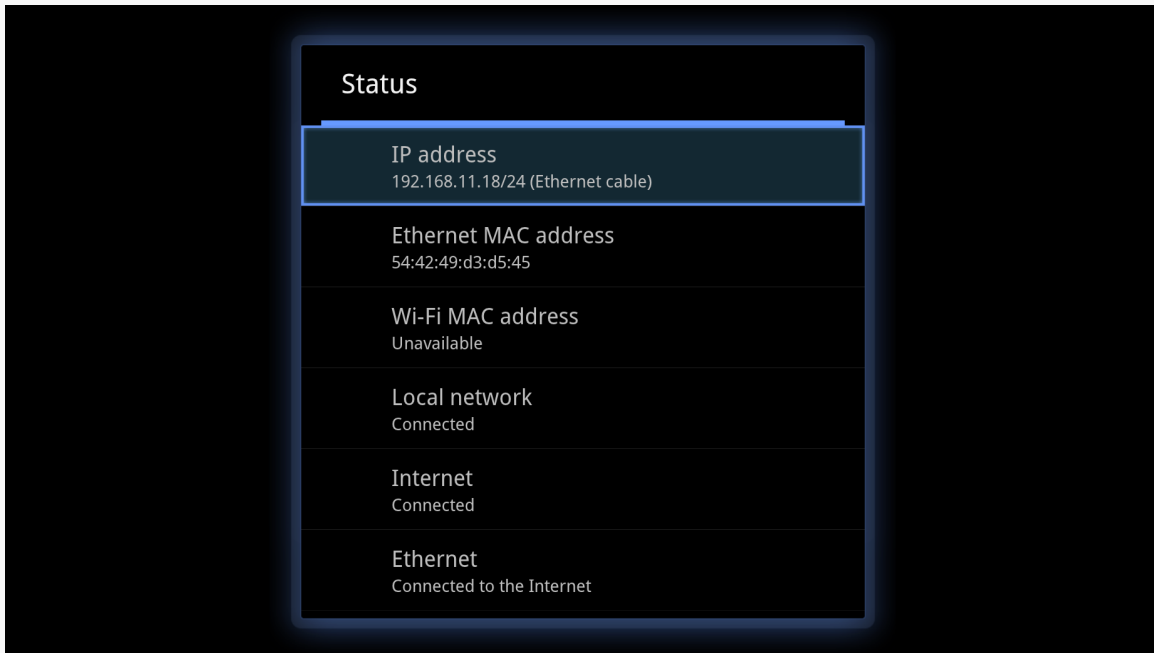
## Connecting to Physical Devices

Normally, when developing using Android hardware, you connect your development machine to the hardware via USB. This is not supported by Google TV, perhaps with an eye towards not requiring Google TV-powered televisions to sport USB ports. Instead, you develop for Google TV by TCP/IP. The tools are mostly ignorant of the difference – only `adb` knows and cares about the USB versus TCP/IP differences.

## DEVICE CATALOG: GOOGLE TV

---

First, you will need the IP address of your Google TV device. You can get this via All Apps > Settings > Network > Status — “IP Address” will be one of the listed pieces of information:



*Figure 544: IP Address on Google TV*

With luck, your network will keep the same IP address assigned to this device, even if you shut down or reboot the device from time to time.

Then, at the command line, run `adb connect`, supplying the IP address of the Google TV device. If the `adb` command is not in your development machine's `PATH`, you will find it in the `platform-tools/` directory of wherever your SDK is installed. At this point, DDMS and `adb devices` should report the Google TV device. Rather than the device ID being a serial number or `emulator-5554`, it will be the IP address plus `:5555`.

At this point, all your normal tools should work, for viewing LogCat and so on. The screenshot shown above, for example, was taken using the DDMS perspective in Eclipse. Note, though, that the screenshots will only be from what Google TV is generating, not any underlying picture being supplied by your television signal input.

To disconnect, simply run `adb disconnect` with the IP address of the Google TV device.

## How Does Distribution Work?

Your app probably falls in one of three buckets: you want it on Google TV (along with other devices), it *only* supports Google TV, or it will not work on Google TV. Whichever of those buckets best fits your device will determine the manifest settings you will want to ensure that the Play Store (and perhaps other third-party markets in the future) will honor your request.

## Getting Your App on Google TV

The first criterion for getting your app visible to Google TV devices on the Play Store is to add a `<uses-feature>` element to your manifest, indicating that you do not require the `android.hardware.touchscreen` feature:

```
<uses-feature android:name="android.hardware.touchscreen"
android:required="false"/>
```

By default, Android assumes that you need a touchscreen, and so without this clarification in your manifest, you will not appear in the Play Store.

Also, add similar `<uses-feature>` elements for any hardware that you might like to use where available but do not absolutely need, particularly hardware that Google TV may lack. The [Google TV developer documentation](#) has the full roster of unsupported features.

Also:

1. If you have any `<uses-configuration>` elements in the manifest, double-check to make sure that they will be possible on Google TV devices. The configurations that Google TV does *not* support are ones where you need the touchscreen (`android:reqTouchScreen="stylus"` or `"finger"`).
2. Do not have any activities with `android:screenOrientation` set to `portrait`, as Google TV devices always display in `landscape`.
3. Apparently not all OpenGL textures are supported, so if you are using `<supports-gl-texture>` elements in your manifest, you will need to ensure that such textures work on Google TV, presumably via testing.

### Supporting Only Google TV

If your app only supports Google TV, in addition to the above requirements, you should also add one more [uses-feature](#) element to your manifest:

```
<uses-feature android:name="com.google.android.tv" android:required="true"/>
```

This will filter you out of the Market for all non-Google TV environments.

### Avoiding Google TV

If your app specifically is untested on Google TV, you need to have something in the manifest that will keep you *off* Google TV devices' views of the Play Store. The easiest is to say that you need a touchscreen:

```
<uses-feature android:name="android.hardware.touchscreen"
android:required="true"/>
```

### Dealing with Other Televisions

There are other devices that support Android on televisions. While few of these exist as of the summer of 2012, many are in the works, such as the oft-cited, crowd-funded [OUYA console](#).

Android 4.1 (a.k.a., Jelly Bean) added a separate feature for televisions: `android.hardware.type.television`. Requiring this would limit your application to devices that are to be displayed on televisions.

However, as of the time of this writing, it is unclear which, if any, devices or markets honor this particular `<uses-feature>` element.

### Getting Help

The [Google TV Developer site](#) has a lot of information on creating Google TV apps, in terms of design and implementation details.

The primary place to get your questions answered regarding Google TV development is [StackOverflow's google-tv tag](#).





# Device Catalog: Kindle Fire

---

Perhaps the most anticipated device of late 2011 was the Kindle Fire, Amazon's first foray into Android devices. Positioned by Amazon as an extension of their existing line of Kindle digital readers, the Kindle Fire is a 7" 1024x600 Android 2.3 device that, while running Android, looks little like any Android device that came before it. Amazon replaced much of the stock user interface with their own, with apps tailored for selling and consuming Amazon content. That being said, app developers can write apps for the Kindle Fire and distribute them, primarily via the Amazon AppStore.

This chapter will outline what you should expect as you start working on apps for the Kindle Fire.

## Prerequisites

Understanding this chapter requires that you have read the core chapters of this book.

## What Features and Configurations Does It Use?

Any time you are looking at a device that is known to be a significant departure from conventional Android devices, you need to consider what capabilities the device has and how that relates to your code and graphic assets. Android's flexibility means that, in many cases, you can work within the limits of the SDK to craft something that will look well on unusual devices. However, you will need to understand what is and is not possible for the device in question, in this case the Kindle Fire.

### Screen Size and Density

The Kindle Fire uses `-large`, `-mdpi` resources. On the surface, this would not be terribly surprising, as the 7" display works out to around 169dpi, and 7" displays are definitely in the `-large` resource bucket.

However, bear in mind that Android 2.3 did not fully support tablets. The only Google-endorsed tablet that shipped with Android 2.x was the original Samsung Galaxy Tab, and that technically was a really large phone that, er, could not place phone calls.

As such, Android 2.3 did not consider a 1024x600 display to be `-large`. It considered such a display to be `-xlarge`. This was corrected in Android 3.1, in preparation for a new line of ~7" Honeycomb tablets.

In general, this should not pose an issue when testing your app on hardware. In practice, it will pose a problem for your emulator, as will be explained [later in this chapter](#).

### Hardware Features

The Kindle Fire supports:

1. An accelerometer, both for direct use and for detecting screen orientation changes
2. Multitouch, but only for two fingers (e.g., pinch-to-zoom)
3. WiFi
4. The USB accessory interface
5. A light/proximity sensor

This leaves out a lot, such as:

1. Camera
2. GPS and network-based location
3. Bluetooth
4. Microphone
5. Telephony (voice or SMS)

If your application truly needs any of those missing capabilities, you are out of luck.

If your application could use some of those capabilities but can get by without them, be sure to add the appropriate `<uses-feature>` elements to your manifest with `android:required="false"` (e.g., `<uses-feature android:name="android.hardware.camera" android:required="false" />`). Otherwise, your app will not be available for the Kindle Fire if Android thinks that you really do need the capability (e.g., you have requested the CAMERA permission).

## What Is Really Different?

All of the devices profiled in this part of the book are clearly different than what you are used to from an Android development standpoint. Some things, like availability of Bluetooth, will fit within the Android SDK's framework for optional capabilities. Other things will represent where a device manufacturer has meandered farther from the Android device norm, in ways that may not be completely obvious to you, let alone your code.

### The Menu Bar

As was noted previously in this chapter, the Kindle Fire runs Android 2.3, a version of Android not designed for tablets. Moreover, Android 2.3 was designed for devices that had dedicated off-screen options for HOME, BACK, and MENU buttons. However, Amazon apparently wanted to avoid such buttons, yet they lacked source code access to Honeycomb, where support for the system bar was added.

So, they faked it.

The Kindle Fire supports what Amazon refers to as the “menu bar”. This is akin to the system bar found on tablets running Android 3.0+, insofar as:

1. It appears at the bottom of the screen
2. It contains the HOME, BACK, and MENU buttons, along with a search button

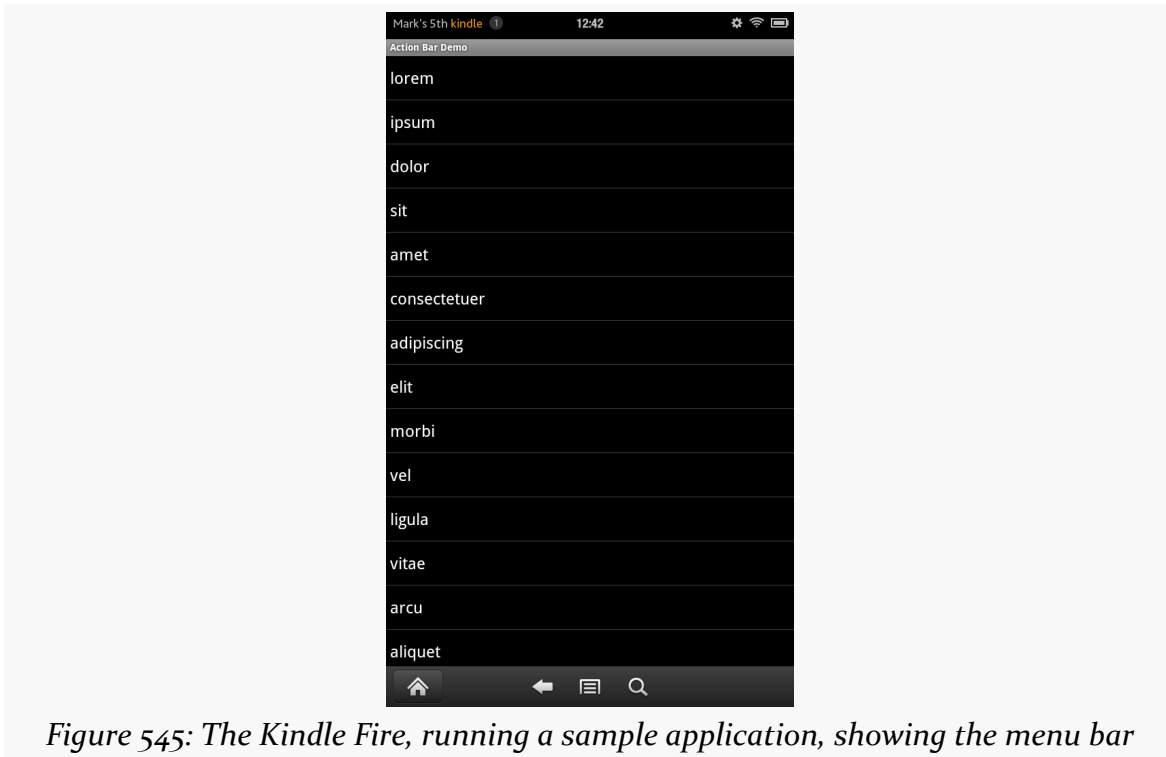
However, unlike the system bar:

1. The menu bar disappears when not in use, in some cases
2. There is still a status bar at the top containing signal strength, battery level, time, etc.

## DEVICE CATALOG: KINDLE FIRE

---

Here, for example, is an application running on the Kindle Fire:



In this case, this is a normal activity, and the menu bar is always visible.

However, here is the same activity with `android:theme="@android:style/Theme.NoTitleBar.Fullscreen"` in the manifest:



*Figure 546: The Kindle Fire, running a sample application, with the menu bar collapsed*

Hence, if you set your activity to be full-screen, the status bar at the top goes away, and the menu bar shrinks to a smaller bar. Tapping on that bar brings back the menu bar, but this time overlaying the bottom portion of your activity.

### **Nothing Googly**

The Kindle Fire lacks Google Maps, both the app and the library used for things like MapView.

The Kindle Fire lacks the Play Store and anything that depends upon it, such as [C2DM](#).

The Kindle Fire lacks Gmail.

The Kindle Fire lacks anything from Google that is not part of the Android Open Source Project.

If your application depends on one or more of these, your app will not work well on a Kindle Fire without adjustments. For example, you might switch to [OSMDroid](#) for your maps.

### Sideloaded Limitations

If you enable the standard Android setting, you can install apps on the Kindle Fire from alternative sources, such as sideloading via USB. This is how the development tools deploy apps to a device when you are working on your app, and anyone can use this technique so long as they have the Android SDK (or at least enough to provide adb access).

However, there is one notable limitation of sideloading: icon quality.

When you submit your app for distribution through the Amazon AppStore, you will upload what they refer to as the “thumbnail” image. This is a 512x512 pixel rendition of your icon and is independent from any icons you may have put as resources in the APK file itself. When your app is installed from the Amazon AppStore, your thumbnail is downloaded as well and is used for the home screen carousel, among other things:

## DEVICE CATALOG: KINDLE FIRE

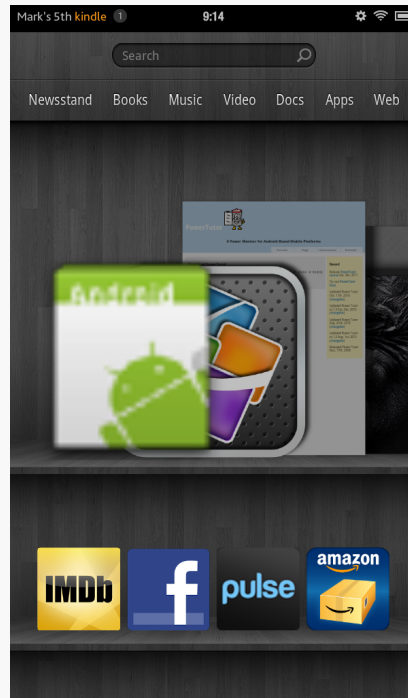
---



*Figure 547: The Kindle Fire home screen, with a high-resolution version of the QuickOffice icon*

However, when you sideload an app, or install it off the Web, there is no “thumbnail”. The Kindle Fire will use your in-APK icon, no different than any other home screen. However, when it blows up your, say, 72x72 pixel icon to the large shelf in the carousel, it does not look very pretty:





*Figure 548: The Kindle Fire home screen, with a not-so-high-resolution version of the stock Android launcher icon*

One can only hope that the Kindle Fire will provide some in-APK way of offering the high-resolution thumbnail.

## Getting Your Development Environment Established

Developing for the Kindle Fire is best accomplished using an actual Kindle Fire device. For example, there is no good way to simulate the behavior of the Kindle Fire menu bar using the standard Android emulator. That being said, having an emulator that at least resembles the Kindle Fire will be useful for debugging purposes, since you can do more with an emulator (e.g., run Hierarchy View) than you can with production devices.

### Emulator Configuration

Originally, Amazon did not distribute an emulator image for the Fire, meaning that developers would have to fake it as best they could using a stock emulator. This was fairly limiting, as the Fire does not look much like a standard Android emulator.

## DEVICE CATALOG: KINDLE FIRE

---

Fortunately, Amazon is now distributing an SDK add-on that supplies an emulator image you can use. Full information about this SDK add-on can be found on the [Amazon developer site](#).

To install it:

- Start the SDK Manager, such as via the toolbar button in Eclipse
- Choose Tools > Manage Add-on Sites from the SDK Manager main menu
- Click on the User Defined Sites tab, and click the New... button
- Fill in `http://kindle-sdk.s3.amazonaws.com/addon.xml` as the URL in the field in the “Add Add-on Site URL” dialog, then click OK (to close up that dialog), then click Close (to close up the Manage Add-on Sites dialog)
- Wait for the progress bar at the bottom of the SDK Manager to finish (pro tip: this is a fine time to get a cup of coffee)
- In the “Android 2.3.3 (API 10)” portion of the SDK Manager, you will find a new “Kindle Fire” entry — check that, then click the “Install 1 package...” button (note: number may vary, if there are other updates that the SDK Manager would like to install)

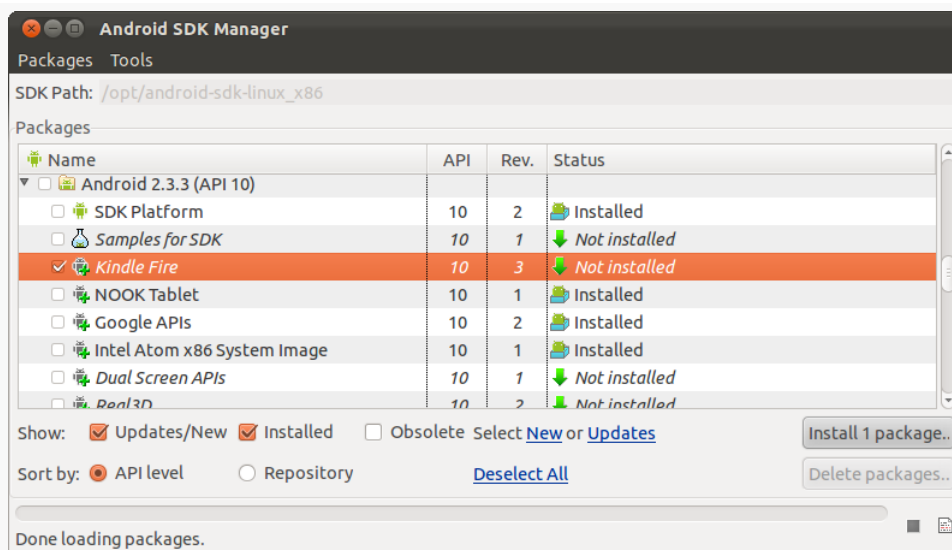
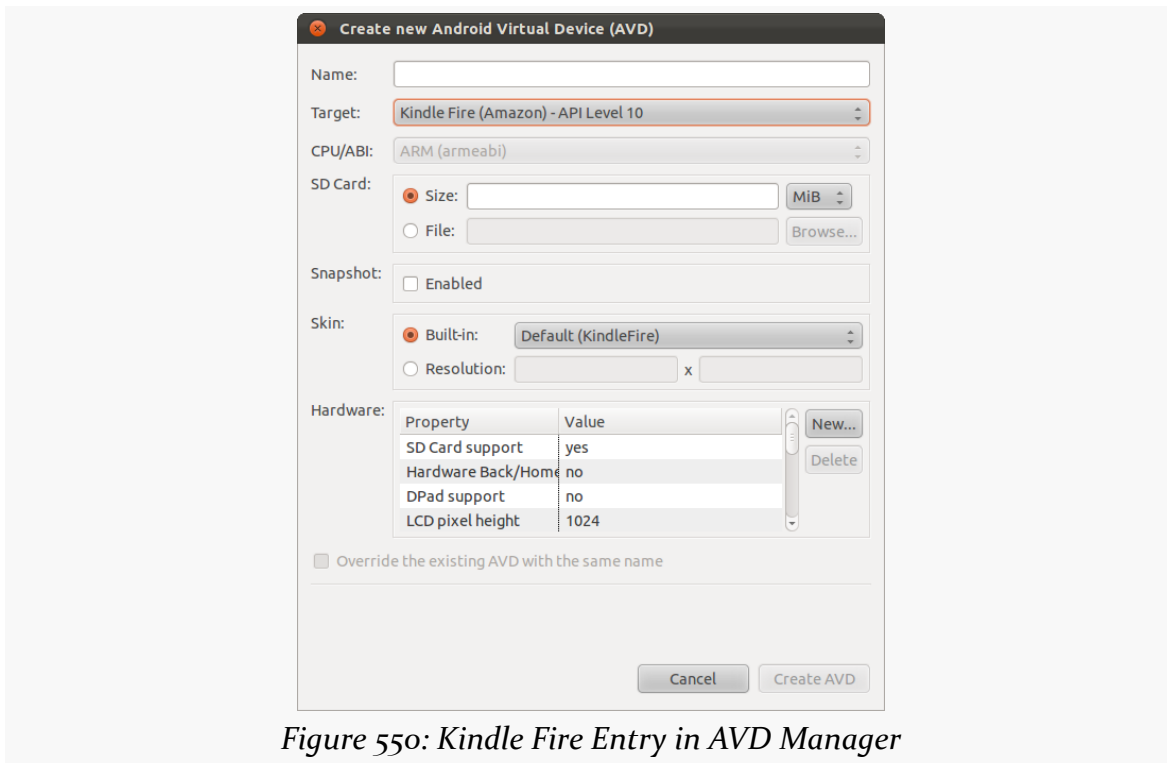


Figure 549: Kindle Fire Entry in SDK Manager

This will give you a new available target in the AVD Manager, named "Kindle Fire (Amazon) - API Level 10":

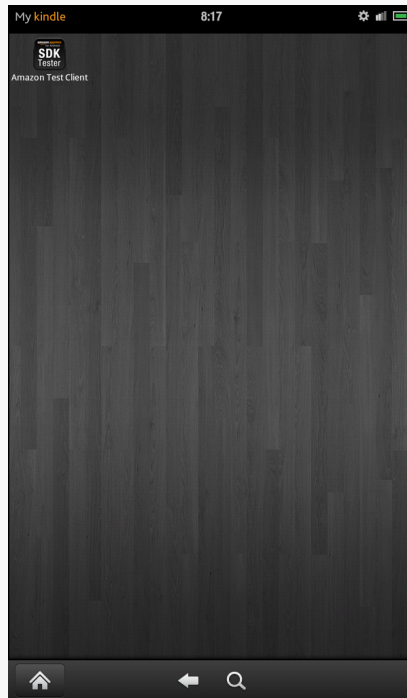
## DEVICE CATALOG: KINDLE FIRE

---



*Figure 550: Kindle Fire Entry in AVD Manager*

This will give you an emulator that reasonably approximates the behavior of a real Kindle Fire device. Note that 7” emulators in portrait mode get a bit tall, in terms of pixels, so be sure to use the scaling option in the AVD Manager to scale down the emulator so that it will fit your development machine’s monitor.



*Figure 551: Kindle Fire Emulator*

The official Kindle Fire emulator image also overcomes a limitation in the standard Android emulator image. As mentioned earlier in this chapter, Gingerbread did not support tablets. More importantly, it had a snippet of code that assumes that devices running with the Kindle Fire's resolution must be `-xlarge`. In reality, the Kindle Fire (and other 7" tablets) should use a `-large` configuration. However, the standard Android emulator will use `-xlarge`. However, the official Kindle Fire emulator will correctly report the emulator as `-large`, matching the device.

### Developing on Hardware

The Kindle Fire is ready for use with your development tools, once you teach your development machine how to have `adb` connect to the fire.

Linux and OS X users simply need to add two lines to the bottom of `~/.android/adb_usb.ini`:

```
0x1949
0x0006
```

On Windows, you need to do that too, but you also have to manually hack into USB driver files, so Windows will recognize your Kindle Fire and install the ADB driver. Details for doing that can be found in [a PDF file](#) published by Amazon.

Note that the Kindle Fire automatically switches into USB Mass Storage mode when you plug it into a PC using the USB cable. This means that apps on the Kindle Fire do not have access to external storage. You will need to unmount the Kindle from your development machine's OS and click the Disconnect button on the Kindle Fire's "You can now transfer files from your computer to Kindle" screen to be both connected via USB *and* allow apps access to external storage.

## How Does Distribution Work?

Unlike the vast majority of Android devices, the Kindle Fire lacks the Play Store. It is quite likely the most popular device ever shipped that does not include the Play Store, though it is far from the first. Hence, if you want your app to be available to Kindle Fire users, you will need to explore other ways of promoting and delivering the app.

### Amazon AppStore

The primary way to reach Kindle Fire users is through the Amazon AppStore. This is Amazon's equivalent to the Play Store. And, unlike the Play Store, which is only available pre-installed on devices, any Android device can download an app client for the Amazon AppStore. That, coupled with Amazon's promotions like the "free app of the day", means that your app on the Amazon AppStore has reach beyond just the Kindle Fire and future Amazon Android devices.

At a high level, publishing on the Amazon AppStore is not significantly different than publishing on the Play Store: you supply the APK and descriptive material to Amazon, and it gets listed. However, the devil, as they say, is in the details:

1. Your app will be reviewed by Amazon before publishing, and it may be rejected for the same sorts of reasons why apps are rejected from the iOS App Store, for anything from content concerns to poor programming practices
2. If you are trying to sell a paid app, Amazon holds final pricing decisions, and your prices on the Amazon AppStore cannot be higher than on other venues

3. Your app will be wrapped in Amazon-supplied code and re-signed by Amazon, so that if a non-Kindle Fire user uninstalls the Amazon AppStore client, your app will no longer run
4. And so on

This is not to say that distributing through the Amazon AppStore is intrinsically a bad idea. Because of some of these hurdles, plus the AppStore's much smaller user base, many developers are skipping it. This results in less competition and greater visibility for your app. However, you need to review all the Amazon AppStore developer rules and make decisions for yourself as to whether it makes sense for you and what you are trying to accomplish with the app.

### Alternatives

Because Amazon did not license the Play Store or other commercial components from Google, you cannot reach Kindle Fire users through the Market (except for those who install pirated versions of the Play Store client on their devices).

However, all other distribution vectors should work as they would on any other device. In addition to sideloading via USB, users can install apps off of the Web by visiting a URL in the device's browser (by default, Amazon Silk) and tapping on the link to the APK. This will trigger a download of the app — users can then tap on the Notification for the download to trigger an install. Similarly, one would imagine that other apps whose job is to download and install apps (e.g., enterprise app “markets”) should work normally as well.

Note, though, that all off-AppStore installs will have rough icons, so you will want to supply your icons in all densities, in hopes that the Kindle Fire will choose a higher-quality rendition of the icon.



# Device Catalog: Barnes & Noble NOOK Tablet

---

While Amazon's Kindle Fire is all the rage in the 7" Android-based tablet space, it certainly was not the first such tablet.

It was not even the first such tablet sold by a firm known originally for selling printed books.

Barnes & Noble, a large American bookstore chain, released the NOOK Color in November 2010 and followed that up with the NOOK Tablet in November 2011. Like the Kindle Fire, the NOOK series are based on Android but have a substantially replaced home screen and other built-in apps. Also, like the Kindle Fire, the NOOK series eschews the Play Store (and any other Google apps) in favor of its own distribution channel.

This chapter will explore developing for the NOOK series, focusing on the newer NOOK Tablet.

## Prerequisites

Understanding this chapter requires that you have read the core chapters of this book.



## What Features and Configurations Does It Use?

In some respects, the NOOK series is closer in spirit to traditional Android devices than is, say, the Kindle Fire. That being said, there are certainly departures from what you would expect, in many cases to keep the parts count and price low.

### Screen Size and Density

Both the NOOK Color and the NOOK Tablet have 1024x600 displays, categorized correctly as `-mdpi` from a screen density standpoint. The NOOK Color is correctly categorized as a `-large` screen, given its 7" diagonal display.

The NOOK Tablet, on the other hand, claims to be `-xlarge`, despite the fact that it too has a 7" diagonal display. This will be a problem if your `-xlarge` resources (e.g., layouts) are really designed for 10" tablets and will not work especially well on a 7" tablet.

### Hardware Features

The NOOK series does not support:

1. Any form of location tracking via `LocationManager`
2. Recording via a microphone
3. Anything involving a camera
4. Anything involving Bluetooth
5. Gyroscope sensors

In addition, the NOOK devices are not phones and so lack any telephony capability, including SMS/MMS.

## What Is Really Different?

Beyond the mis-categorizing of the NOOK Tablet as an `-xlarge` device, there are other places where the NOOK series has departed from standard Android conventions, even within the flexibility supported by the Android OS.

## Status/System Bar and Navigation Norms

If you play around with a NOOK Tablet, you will discover that there are no obvious BACK and MENU buttons anywhere on the screen. Most of the built-in applications eschew BACK and MENU, though, preferring iOS-style on-screen backwards navigation, albeit with inconsistent styling.

If you try your own apps, they should cause BACK and MENU buttons to appear, very small, in the status bar that exists at the bottom of the screen. Most of the time, this status bar simply shows the time, battery charge, etc.

Similarly, there is no HOME button. The raised “horseshoe” button towards the bottom of the device, when pressed, brings up a menu of places to navigate to, one of which is the home screen. Note that this behavior only appears on hardware; the NOOK Tablet emulator seems to completely ignore that button and offers no obvious means of getting back to the home screen directly from your app.

## Nothing Googly

As with the Kindle Fire, the NOOK series of devices lack any of the Google apps. This includes Google Play for installing other apps, Google Maps (and the Maps SDK add-on), and so on. You will need to find alternatives as needed.

## No Side-loading

As will be discussed in greater detail [later in this chapter](#), side-loading of apps is limited at best on the NOOK series.

## Toasts to the Top

Whereas in standard Android, the default positioning of a Toast is towards the bottom of the screen, on the NOOK Tablet, it is positioned towards the top.

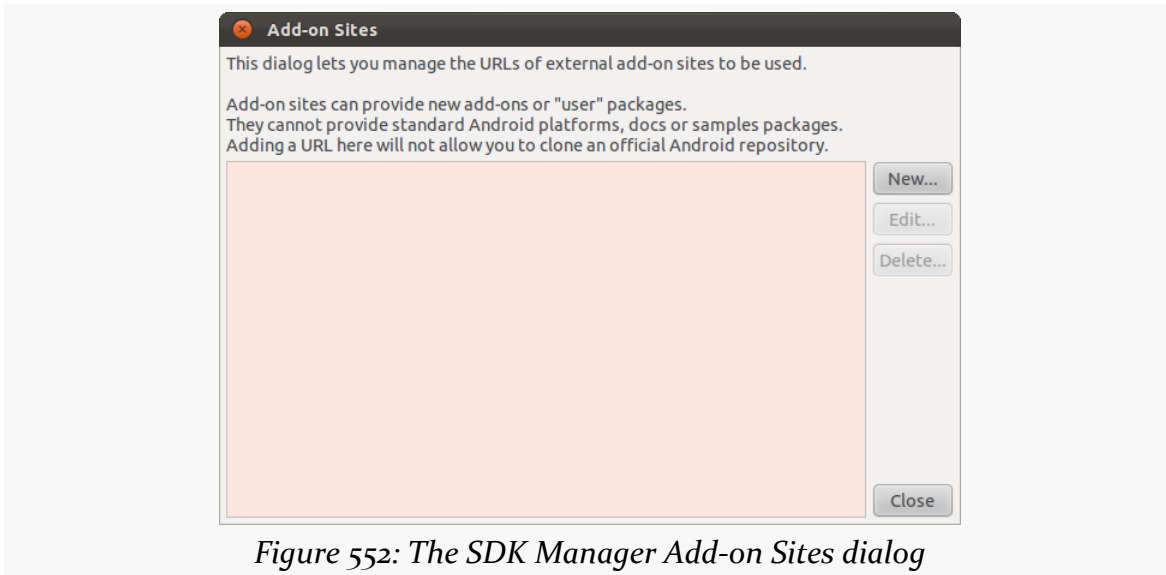
## Unsupported APIs

The NOOK devices do not support home screen app widgets or text-to-speech.

## Getting Your Development Environment Established

The [NOOK Developer site](#) offers its own SDK for NOOK development. The NOOK SDK is an add-on for the Android SDK environment, so you will need to start with the standard Android SDK tools and such before proceeding.

From the Android SDK Manager, choose Tools | Manage Add-on Sites... This will bring up a dialog box that you can use for adding vendor-supplied add-ons that are not part of Google's central add-on registry:



*Figure 552: The SDK Manager Add-on Sites dialog*

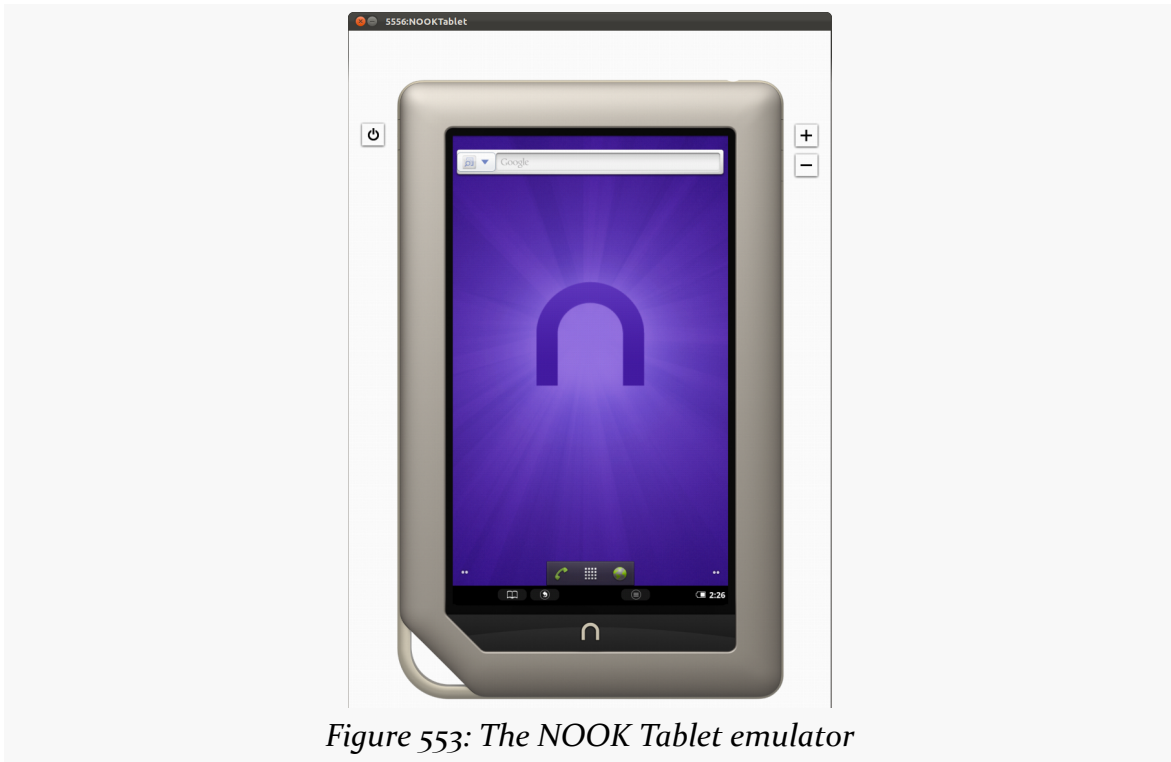
Note that you might need to resize the dialog for the buttons on the right to appear.

In that dialog, click New... and fill in `http://su.barnesandnoble.com/nook/sdk/addon.xml` as the URL. Then click OK to close the dialog, and Close to close the Add-on Sites dialog. You should find a new NOOKcolor entry in the Android 2.2 section of your SDK Manager, which you can then check and install. You can repeat the process with `http://su.barnesandnoble.com/nook/sdk/Nook_Tablet_addon.xml` for installing the NOOK Tablet add-on, which will appear in the 2.3.3 section of your SDK Manager.

## Emulator Configuration

The primary reason for installing those SDK add-ons is to get access to official NOOK emulator images. With the add-ons installed, your AVD Manager will allow you to create NOOK Color and NOOK Tablet emulators, just as you would create emulators for various Android API levels.

Note that the NOOK emulator has a lot of space-consuming chrome around the actual display:



*Figure 553: The NOOK Tablet emulator*

As a result, you may need to scale the emulator down smaller than the physical 7" of the actual device, simply because the emulator image is too tall.

Also note that the NOOK emulator does not correctly report an OS version to Eclipse, so you may find that when you try to run your app, Android launches some other emulator. Right click on the project and choose Run As > Run Configurations, and change the project to Manual deployment target selection on the Target tab of the Run Configurations dialog.

## Developing on Hardware

The NOOK people make it very annoying to attempt to develop on NOOK hardware, for unknown reasons.

Officially, you need to file paperwork to become a “qualified NOOK App Developer”. This is not possible except for US residents (or firms with a US tax ID from a small list of other supported countries). You also already have to have a production app released elsewhere, and your request has to be approved by the NOOK team.

While there used to be procedures for getting past this restriction, recent firmware updates for the NOOK Tablet have blocked those procedures. At the time of this writing, short of fully rooting the device (and potentially replacing the firmware), development on the NOOK Tablet does not appear possible short of going through the official mechanism.

## How Does Distribution Work?

Short of rooting and modding, app distribution for the NOOK series is purely through the Barnes & Noble Storefront. There is no fee to become a “qualified NOOK App Developer” to submit your apps to the Storefront, and you get 70% of the list price of paid apps, on par with similar distribution mechanisms.

The limited distribution options for the NOOK series make it an unsuitable device for use with private apps (e.g., enterprise development), short of rooting and modding.

# Device Catalog: RIM Blackberry Playbook

---

Research In Motion (RIM) are known around the world for their Blackberry line of phones and messaging services. In 2011, they leapt into the tablet arena with the Blackberry Playbook. The 2.0 version of the Playbook OS supports running carefully repackaged Android applications, and you can distribute these applications through a RIM-supplied marketplace if you so choose.

## What Features and Configurations Does It Use?

Android offers a reasonable amount of flexibility to device manufacturers, while simultaneously allowing developers to dynamically adapt to different device capabilities. This section outlines what you should expect from the Playbook.

### Screen Size and Density

The Playbook has a 7" 1024x600 screen. It correctly advertises itself as a -large -mdpi device and will try to pull its resources from those sets.

### Hardware Features

The Playbook, like most tablets, is not a phone, and so it does not support any telephony capability, including SMS/MMS.

Beyond that, Android apps on the Playbook cannot access:

1. Some sensors, notably proximity, ambient light, and barometer
2. Bluetooth

3. miscellaneous other ill-supported technologies (e.g., NFC)

Also, like most tablets, the Playbook does not have any sort of navigation input besides the touchscreen — no D-pad, trackball, arrow keys, etc. Hence, if you have <uses-configuration> elements that require one of these, your app will not work on the Playbook.

## What Is Really Different?

The Playbook is different in part because it is not truly an Android device, but a Blackberry device that happens to have a “runtime” for Android, much like a Web browser might have a runtime for Flash. As such, there are going to be a number of things that will depart from the Android norm that your application might expect.

### Navigation

Like most Android tablets, the Playbook offers little in the way of physical or off-screen navigation buttons. For example, there is no BACK button. However, a navigation bar will contain a BACK soft button for users. If your app takes over the full screen, this bar will not be there all the time, but a swipe down from the top of the screen should expose it. Users can also learn the BACK gesture – a diagonal swipe from southeast to northwest.

Similarly, your menu will not be accessed via a MENU key, but rather via a downward swipe to expose the menu. This also means that any special MENU-button logic of yours may not work.

### Nothing Googly

By definition, a non-standard Android device lacks the Google apps, such as Google Play, Google Maps, and so on. The Playbook does support `geo:` as a scheme for an Intent when used with `startActivity()`, but you cannot directly integrate Google Maps into your application using `MapView` and `MapActivity`. RIM recommends using `WebView` and the Google Maps Web-based APIs instead.

### BARs as Packages

One of the biggest differences, compared to other Android-based devices, is the application file format. You are used to distributing APK files, whether via Google Play or by other means. The Playbook, instead, plays BAR files. You will need to go

through a process to “repackage” your APK into a BAR file for local testing or uploading to Blackberry App World. Fortunately, RIM provides a number of means for doing this, described [later in this chapter](#).

## Unsupported APIs

In addition to the Google app limitations, the Playbook does not support:

1. Home screen app widgets
2. Any app with more than one launcher activity
3. SIP
4. Native code via the NDK
5. Text-to-speech
6. Task management APIs, notably those protected by `GET_TASKS` and `KILL_BACKGROUND_PROCESSES`
7. Some methods on `AudioManager` and `MediaPlayer`, mostly targeting Bluetooth devices and vibration motors
8. The `Camera` class (though accessing the camera via `ACTION_GET_CONTENT` should work)

In addition, the Playbook does not support some media types normally supported by Android, including Ogg Vorbis, AMR, FLAC, MIDI, H.263, and VP8.

## Package Name Length

The Playbook Android runtime only supports package names of 29 characters or less. The build tools will truncate your package name as needed, though you may need to give it some assistance to determine how best to do that (e.g., use the first 29 characters? the last 29 characters?).

## Getting Your Development Environment Established

Developing for the Playbook is significantly different than is developing for other Android devices, simply because the Playbook is not really an Android device. It is a Blackberry device that happens to have an Android runtime environment in it.



## Checking and Repackaging Your App

You need to convert your APK into a BAR file for test it on the Playbook Simulator or on an actual Playbook. There are three ways to go about this: use an Eclipse plug-in, use an online packager, or use some command-line tools.

### Eclipse Plugin

RIM publishes an Eclipse plugin that will handle most of the chores for you: test your app for compatibility, convert it into a BAR, apply signing keys, etc. This plugin is certified for use on Windows and OS X; RIM does not mention support for Linux. This plugin also supports the creation of run configurations to deploy your app to a device or simulator, including supporting IP-based debugging.

### Online Repackager

For lightweight use, RIM supplies a [Web-based version of the same tools](#), minus the Eclipse integration and debugging. This too, though, only supports Windows and OS X, despite being browser-based. It relies on a Java applet, so your browser will need to have that enabled as well.

### Command-Line Tools

The only option available for Linux are the command-line tools (though these also support Windows and OS X). There are separate commands for the major steps in the process:

1. `apk2barVerifier` runs a validation check to see if you obviously use or do something that makes your app incompatible (e.g., require API Level 11, as the Playbook runs API Level 10)
2. `apk2bar` creates a BAR file out of the APK file (optionally running `apk2barVerifier` first, to save you running that separately)
3. `batchbar-deploy` will upload one or more BAR files to a device or running copy of the simulator
4. etc.

### Playbook Simulator

RIM offers a Playbook simulator in the form of a VMWare image. Because of the nature of their Android runtime for the Playbook, RIM does not support the

standard Android emulation environment. And, given the extensive modifications to their edition of Android, you are probably better served either trying to use their VMWare image or developing on actual Playbook hardware. This image is certified for use on Windows and OS X, though RIM does not mention support for Linux (even though there is a VMWare player for Linux).

The VMWare image will have its own IP address, which you can obtain from the Playbook simulator running in the image. You can then deploy your BAR to it using the Eclipse plugin or the command-line `blackberry-deploy` tool.

### Developing on Hardware

The Playbook can run either signed or unsigned BAR files. Unsigned BAR files, though, require a one-time upload of a “debug token”, the creation of which requires the same credentials as you would use to sign the BAR in the first place. Signing credentials are [available from RIM through a Web form](#), though they require agreeing to a fairly lengthy [SDK License Agreement](#).

## How Does Distribution Work?

RIM is expecting apps to be distributed to the Playbook primarily through their App World site, which also has Playbook apps that are native to the device (vs. running in the Android runtime).

### Blackberry App World

Compared to marketplaces for apps for some non-standard Android devices, Blackberry App World is full-featured and extensive. It not only supports the Playbook but all app-capable Blackberry devices. At the present time, App World does not take a percentage of each sale.

### Alternatives

Side-loading is possible, using the techniques from development. However, there is no indication that over-the-air installation is possible other than through Blackberry App World.



# Accessory Catalog: SONY SmartWatch

---

The preceding chapters in this trail are focused on odd hardware that runs Android natively on the hardware itself. There is a second set of hardware of particular interest to Android developers: accessories. These are devices that can connect to an Android device (e.g., via Bluetooth), but do not run Android themselves. Rather, the accessories are designed to interoperate with Android apps running on the connected Android device.

The first of these that we will examine is [the SONY SmartWatch™](#).

## Prerequisites

Understanding this chapter requires that you have read the core chapters, particularly the chapters on [broadcast Intents](#) and [services](#). The sample app shown in this chapter uses the [device administration APIs](#), so reading that chapter will help you make sense of the business logic of the sample.

## What Can This Thing Really Do?

Well, technically, the SONY SmartWatch does not do much on its own:

- It can display content on its 128x128 pixel display... sort of
- It can respond to touch events, including two-finger touch and swipe gestures... sort of
- It can vibrate upon request... sort of

- It can detect motion via an accelerometer and respond to that motion... sort of

The “sort of” is because the SmartWatch itself does not do any of this by itself. It is an input/output device, but it does not run apps directly. The SmartWatch must be paired with a suitable Android device over Bluetooth, and SONY-supplied SmartWatch software will deliver content, dispatch touch and accelerometer events, etc.

## What Are You Really Writing?

You are writing an Android application that will run on an Android phone. That application can have whatever functionality it desires. It can *also* expose some interfaces designed to hook into the SmartWatch management software, whereby your app can be the one to define the content displayed on the SmartWatch and can be the one to respond to touch events.

Since your app will run on a regular Android device, you will have the full range of device capabilities to tie into, from the Internet to GPS to data already resident on that device, like contacts or calendar events.

However, interacting with the SmartWatch departs from the norms of writing activities. It is a bit reminiscent of writing [app widgets](#), to the point where it might have been nice if SONY had simply adopted that pattern and had you publish app widgets designed for 128x128 bits of screen real estate. As with app widgets, your SmartWatch business logic will be in `BroadcastReceivers` and `Services`. Unlike app widgets, your API for interacting with the SmartWatch is very low-level: you push over a `Bitmap` and receive raw touch data akin to `MotionEvent`s delivered to `onTouchEvent()` in an activity.

There are several types of functionality you can tie into the SmartWatch:

- You can push stuff to the watch via a notification API (e.g., for incoming SMS messages)
- You can take over the full screen, through what is known as the “control API”
- You can take over part of the screen, through what is known as the “widget API”

There are also APIs for dealing with the vibration motor and accelerometer (“sensor API”) and APIs for dealing with the SmartWatch environment overall, though the latter are largely handled for you by the SmartWatch SDK.

Note that while this chapter will focus on the control API and the SmartWatch, not only can you use the other APIs, but there are other SONY accessories that will work using the same SDK. At present, there is a Bluetooth-powered headset with some limited display capability that you can use. It is also well within reason that SONY will come up with other such accessories in the future, whether they be next-generation editions of these form factors or are something totally new.

## Getting Your Development Environment Established

SONY has an SDK for their “Smart Extras™” devices, like the SmartWatch, for creating compatible apps (a.k.a., “Smart Extensions”). You can download that SDK [from the SONY Developer site](#).

This SDK includes:

- Documentation
- A Smart Extension emulator, so you can test your apps without hardware (though, as with all unusual hardware, having actual hardware is largely essential if you plan on shipping the app)
- A pair of Android library projects that you will need, curiously hidden in a “Code\_examples” directory of the Smart Extension SDK ZIP file (as of the time of this writing)

Of the two library projects (SmartExtensionAPI and SmartExtensionUtils), the SmartExtensionUtils library project depends upon the SmartExtensionAPI project, so by adding SmartExtensionUtils as a library project in your own app, you will have both libraries available to you.

If you plan on testing on an actual SmartWatch, you will need to get that SmartWatch set up with your device first before trying to run your own applications on it. That involves, among other things, downloading and installing the LiveWare™ manager application from the Play Store.

## How Does Distribution Work?

You can distribute your SmartWatch applications by any means at your disposal, whether through a formal market (e.g., Google Play Store) or directly (e.g., download from a Web site). The SmartWatch software (e.g., LiveWare manager) will monitor for new extensions and will connect them to the device on the fly.

This also means that you can choose your desired payment model. For example, you might distribute the app for free, but only enable the SmartWatch integration based on an in-app purchase.

## Example: WatchAuth

The sample app that we will examine in this chapter is [SmartWatch/WatchAuth](#). This combines a Smart Extension with the [device administration APIs](#) to add something a bit like two-factor authentication to an Android device. When the user unlocks their device, they also have to launch and tap on an extension app on their SmartWatch within a certain period of time. Otherwise, the device will re-lock automatically.

**NOTE:** Any actual improved security supplied by this sample app is purely coincidental. WatchAuth should not be used to secure nuclear power plants, heart monitors, or nuclear-powered heart monitors.

This chapter will focus on the SmartWatch-specific logic, more so than the device administration portions, which are already covered elsewhere. And, this chapter is designed to give you an idea of how to build SmartWatch extensions and by no means is a complete reference on the subject.

Note that if you wish to use this project from the GitHub repo, you will have to adjust it to refer to your own copy of the SONY SmartExtensionUtils Android library project.

## The ExtensionReceiver

The primary entry point into your control extension is a BroadcastReceiver. This receiver needs to be set up to listen to a bunch of different broadcasts sent out by the LiveWare manager:

```
<receiver android:name="AuthExtensionReceiver">  
  <intent-filter>
```

```
<action
android:name="com.sonyericsson.extras.liveware.aef.registration.EXTENSION_REGISTER_REQUEST"/>
  <action
android:name="com.sonyericsson.extras.liveware.aef.registration.ACCESSORY_CONNECTION"/>
    <action android:name="android.intent.action.LOCALE_CHANGED"/>
    <action android:name="com.sonyericsson.extras.aef.control.START"/>
    <action android:name="com.sonyericsson.extras.aef.control.STOP"/>
    <action android:name="com.sonyericsson.extras.aef.control.PAUSE"/>
    <action android:name="com.sonyericsson.extras.aef.control.RESUME"/>
    <action android:name="com.sonyericsson.extras.aef.control.ERROR"/>
    <action android:name="com.sonyericsson.extras.aef.control.KEY_EVENT"/>
    <action android:name="com.sonyericsson.extras.aef.control.TOUCH_EVENT"/>
    <action android:name="com.sonyericsson.extras.aef.control.SWIPE_EVENT"/>
  </intent-filter>
</receiver>
```

All that BroadcastReceiver needs to do, though, is to pass the received Intent along to an ExtensionService implementation, in our case known as AuthExtensionService:

```
package com.commonware.watchauth;

import android.content.BroadcastReceiver;
import android.content.Context;
import android.content.Intent;

public class AuthExtensionReceiver extends BroadcastReceiver {
    @Override
    public void onReceive(final Context ctxt, final Intent i) {
        i.setClass(ctxt, AuthExtensionService.class);
        ctxt.startService(i);
    }
}
```

## The ExtensionService

The ExtensionService base class is supplied by the SONY SDK's library projects. You need to create a subclass of it and supply four methods:

- the constructor, where you supply a name of your service for use in logging
- getRegistrationInformation(), where you return a RegistrationInformation object containing details about your extension (described in greater detail below)
- keepRunningWhenConnected(), indicating whether you need your components to stay in memory or not in between interactions with the SmartWatch
- createControlExtension(), where you will see if the displays available on this particular accessory happen to match your requirements and, if so, you



## ACCESSORY CATALOG: SONY SMARTWATCH

---

return a ControlExtension object describing your specific “control API” application (described in greater detail below)

```
package com.commonware.watchauth;

import com.sonyericsson.extras.liveware.extension.util.ExtensionService;
import com.sonyericsson.extras.liveware.extension.util.control.ControlExtension;
import com.sonyericsson.extras.liveware.extension.util.registration.DeviceInfo;
import com.sonyericsson.extras.liveware.extension.util.registration.DisplayInfo;
import com.sonyericsson.extras.liveware.extension.util.registration.RegistrationAdapter;
import com.sonyericsson.extras.liveware.extension.util.registration.RegistrationInformation;

public class AuthExtensionService extends ExtensionService {
    public static final String EXTENSION_KEY=
        "com.commonware.watchauth.key";

    public AuthExtensionService() {
        super(EXTENSION_KEY);
    }

    @Override
    protected RegistrationInformation getRegistrationInformation() {
        return(new AuthRegistrationInformation(this));
    }

    @Override
    protected boolean keepRunningWhenConnected() {
        return(false);
    }

    @Override
    public ControlExtension createControlExtension(String hostAppPackageName) {
        final int w=AuthSmartWatch.getSupportedControlWidth(this);
        final int h=AuthSmartWatch.getSupportedControlHeight(this);

        for (DeviceInfo device : RegistrationAdapter.getHostApplication(this,
hostAppPackageName)
                .getDevices()) {
            for (DisplayInfo display : device.getDisplays()) {
                if (display.sizeEquals(w, h)) {
                    return(new AuthSmartWatch(hostAppPackageName, this));
                }
            }
        }

        throw new IllegalArgumentException("No properly-sized control for: "+
hostAppPackageName);
    }
}
```

### The RegistrationInformation

Your RegistrationInformation object supplies information about your extension application, such as what APIs you need (e.g., return 1 from `getRequiredControlApiVersion()` for a control app, but if you are not using sensors, return 0 from `getRequiredSensorApiVersion()`). You also populate a lightly-documented ContentValues of text and icons, such as the name of your extension and the icons that should be used on the watch (for the user to tap on to run your app) and in the LiveWare manager. You also need to implement an `isDisplaySizeSupported()` method that will confirm that, indeed, your control will fit in the display space provided by this particular accessory.

So, for example, the AuthRegistrationInformation class used by WatchAuth looks like this:

```
package com.commonware.watchauth;

import com.sonyericsson.extras.liveware.aef.registration.Registration;
import com.sonyericsson.extras.liveware.extension.util.ExtensionUtils;
import com.sonyericsson.extras.liveware.extension.util.registration.RegistrationInformation;
import android.content.ContentValues;
import android.content.Context;

public class AuthRegistrationInformation extends
    RegistrationInformation {
    final Context ctxt;

    protected AuthRegistrationInformation(Context ctxt) {
        this.ctxt=ctxt;
    }

    @Override
    public int getRequiredControlApiVersion() {
        return(1);
    }

    @Override
    public int getRequiredSensorApiVersion() {
        return(0);
    }

    @Override
    public int getRequiredNotificationApiVersion() {
        return(0);
    }

    @Override
    public int getRequiredWidgetApiVersion() {
```

```
        return(0);
    }

    @Override
    public ContentValues getExtensionRegistrationConfiguration() {
        ContentValues values=new ContentValues();

        values.put(Registration.ExtensionColumns.CONFIGURATION_ACTIVITY,
            AuthPreferenceActivity.class.getName());
        values.put(Registration.ExtensionColumns.CONFIGURATION_TEXT,
            ctxt.getString(R.string.configuration_text));
        values.put(Registration.ExtensionColumns.NAME,
            ctxt.getString(R.string.extension_name));
        values.put(Registration.ExtensionColumns.EXTENSION_KEY,
            AuthExtensionService.EXTENSION_KEY);
        values.put(Registration.ExtensionColumns.HOST_APP_ICON_URI,
            ExtensionUtils.getUriString(ctxt, R.drawable.ic_launcher));
        values.put(Registration.ExtensionColumns.EXTENSION_ICON_URI,
            ExtensionUtils.getUriString(ctxt,
                R.drawable.ic_extension));
        values.put(Registration.ExtensionColumns.NOTIFICATION_API_VERSION,
            getRequiredNotificationApiVersion());
        values.put(Registration.ExtensionColumns.PACKAGE_NAME,
            ctxt.getPackageName());

        return(values);
    }

    @Override
    public boolean isDisplaySizeSupported(int width, int height) {
        return((width == AuthSmartWatch.getSupportedControlWidth(ctxt)) && (height
            == AuthSmartWatch.getSupportedControlHeight(ctxt)));
    }
}
```

### The ControlExtension

The heart of any extension app that implements the control API is the ControlExtension. Like an Activity, this has lifecycle methods letting you know when the control is visible or not. This is also where you will receive touch events from the watch and where you will push bitmaps up to the watch that represent your user interface.

The WatchAuth implementation of ControlExtension is AuthSmartWatch and has the logic outlined in these next few sections.

### Getting the Size

We need to make sure that we are sizing our contents appropriately, since the watch will not do that for us. The SmartExtensionUtils library project defines a pair of dimension resources for SmartWatch control apps:

R.dimen.smart\_watch\_control\_width and R.dimen.smart\_watch\_control\_height. We return those from static data members for use elsewhere (e.g., in the ExtensionService), plus hold onto those values for our use in rendering the UI:

```
AuthSmartWatch(final String hostAppPackageName, final Context context) {
    super(context, hostAppPackageName);
    width=getSupportedControlWidth(context);
    height=getSupportedControlHeight(context);
}

public static int getSupportedControlWidth(Context context) {
    return context.getResources()
        .getDimensionPixelSize(R.dimen.smart_watch_control_width);
}

public static int getSupportedControlHeight(Context context) {
    return context.getResources()
        .getDimensionPixelSize(R.dimen.smart_watch_control_height);
}
```

### Rendering the UI

A likely time to display your control's initial contents is in onResume(). Here, you build up a Bitmap of whatever you want to display on the 128x128 screen and deliver that to the watch via a showBitmap() method you can call on your ControlExtension superclass.

*How you create that Bitmap is up to you. It could be just about anything:*

- A drawable resource
- A local image file you load in via BitmapFactory
- Something you draw to a Bitmap-backed Canvas using the 2D drawing API
- The contents of a layout file that you in turn render into a Bitmap-backed Canvas

That latter approach is what AuthSmartWatch does, using res/layout/main.xml:

```
<?xml version="1.0" encoding="utf-8"?>
<com.sonyericsson.extras.liveware.extension.util.AefTextView
xmlns:android="http://schemas.android.com/apk/res/android"
```

```
android:id="@+id/confirm"  
android:layout_width="@dimen/smart_watch_control_width"  
android:layout_height="@dimen/smart_watch_control_height"  
android:gravity="center_vertical"  
android:text="@string/confirm"  
android:textColor="@color/smart_watch_text_color_orange"  
android:textSize="35px"  
android:textStyle="bold"/>
```

In `onResume()`, if we do not already have our layout, we create a root `LinearLayout` element, set to the proper size, then inflate `R.layout.main` into it using a `LayoutInflater`. Normally, Android will handle calls to `measure()` and `layout()` as part of rendering an activity, but in this case we have no activity, so we need to call those as well. Plus, we register ourselves as the `OnClickListener` for the `TextView`.

```
@Override  
public void onResume() {  
    if (content == null) {  
        LinearLayout root=new LinearLayout(mContext);  
        root.setLayoutParams(new LayoutParams(width, height));  
  
        content=  
            (ViewGroup)LayoutInflater.from(mContext)  
                .inflate(R.layout.main, root);  
        content.measure(width, height);  
        content.layout(0, 0, content.getMeasuredWidth(),  
            content.getMeasuredHeight());  
        content.findViewById(R.id.confirm).setOnClickListener(this);  
    }  
  
    Bitmap mBackground=  
        Bitmap.createBitmap(width, height, BITMAP_CONFIG);  
  
    mBackground.setDensity(DisplayMetrics.DENSITY_DEFAULT);  
  
    Canvas canvas=new Canvas(mBackground);  
    content.draw(canvas);  
  
    showBitmap(mBackground);  
}
```

Once we have the UI inflated and laid out, we can create a `Bitmap` to serve as the background on which our layout will be rendered. We create a `Canvas` object backed by that `Bitmap`, then tell the `LinearLayout` to draw itself onto that `Canvas`, which in turn updates the `Bitmap` backing store. That resulting `Bitmap` is passed to `showBitmap()`, which in turn will deliver the image to the watch for display.

`WatchAuth` is a tiny app from a UI standpoint, so this is all we are doing in terms of pushing images to the watch. You could update the watch on a regular basis, or

based on other events (e.g., touches). However, do bear in mind that these images are being delivered over Bluetooth, which will limit how frequently you can update the watchface.

### Responding to Touch Events

When the user taps on the watch with our control in the foreground, `onTouch()` will be called on our `ControlExtension`, and we can override that to get the touch event and do useful stuff. `onTouch()` works a bit like `onTouchEvent()` on a `View` or `Activity`, except that instead of a standard `MotionEvent`, we get a `ControlTouchEvent` with a similar, but not identical, set of values.

In our case, `onTouch()` in `AuthSmartWatch` will wait for the user to lift their finger off the screen (`TOUCH_ACTION_RELEASE`), then find the widget in the UI that the user touched upon and perform the standard click event upon it:

```
@Override
public void onTouch(final ControlTouchEvent event) {
    if (event.getAction() == Control.Intents.TOUCH_ACTION_RELEASE) {
        View match=
            findBestTouchMatch(content, event.getX(), event.getY());

        if (match != content) {
            match.performClick();
        }
    }
}
```

The `findBestTouchMatch()` method is a recursive method, hunting through the widget hierarchy of our layout, looking for whatever best matches what the user tapped upon, based on the touch event's X/Y coordinates:

```
static View findBestTouchMatch(ViewGroup parent, int x, int y) {
    Rect r=new Rect();

    for (int i=0; i < parent.getChildCount(); i++) {
        View child=parent.getChildAt(i);

        child.getHitRect(r);

        if (r.contains(x, y)) {
            if (child instanceof ViewGroup) {
                return(findBestTouchMatch((ViewGroup)child,
                    x - child.getLeft(),
                    y - child.getTop()));
            }
            else {
```

```
        return(child);
    }
}

return(parent);
}
```

Our `onClick()` implementation for our `TextView` sends a command to an `IntentService` named `AuthDetectionService`, letting us know that the user tapped on the `TextView` and therefore the device should remain unlocked:

```
@Override
public void onClick(View v) {
    if (v.getId() == R.id.confirm) {
        Intent i=new Intent(v.getContext(), AuthDetectionService.class);

        i.setAction(AuthDetectionService.CMD_VALIDATE);
        v.getContext().startService(i);
    }
}
```

Again, `AuthSmartWatch` is a fairly trivial `ControlExtension`. A 128x128 implementation of Rovio's `Angry Birds` would result in a much more complex `ControlExtension` (not to mention be very difficult to play on a watch-sized display).

### The Permission

To be able to interoperate with the `LiveWare` manager, we need to request a SONY-supplied permission in our manifest:

```
<uses-permission
android:name="com.sonyericsson.extras.liveware.aef.EXTENSION_PERMISSION"/>
```

### Highlights of the Business Logic

One of the bits of information supplied by means of the `RegistrationInformation` object is the name of a `PreferenceActivity` that you implement to configure the app. The `LiveWare` manager will allow the user to go in and access that activity from your extension's entry in the list of installed extensions.

There are two pieces of information that we want to collect in the preferences: whether or not to enable the authentication logic, and how long the user has between unlocking the device and tapping on our extension on the watch, before we

automatically lock the device. These are handled by a `CheckboxPreference` and `ListPreference`, respectively.

However, we have some work to do if the user taps the `CheckboxPreference`. For starters, if the user has not yet approved us for our device administration role, we need to prompt them to do that. That is handled by `onPreferenceChange()` in our `PreferenceFragment`:

```
@Override
public boolean onPreferenceChange(Preference pref, Object newValue) {
    if (KEY_ENABLED.equals(pref.getKey())) {
        boolean value=((Boolean)newValue).booleanValue();

        if (value) {
            Intent intent=
                new Intent(DevicePolicyManager.ACTION_ADD_DEVICE_ADMIN);
            intent.putExtra(DevicePolicyManager.EXTRA_DEVICE_ADMIN, cn);
            intent.putExtra(DevicePolicyManager.EXTRA_ADD_EXPLANATION,
                getString(R.string.device_admin_explanation));
            startActivity(intent);
        }
        else {
            mgr.removeActiveAdmin(cn);
        }
    }

    return(true);
}
```

To find out when the user unlocks the device, we implement a `BroadcastReceiver`, named `UnlockReceiver`, that is registered in the manifest to listen for `android.intent.action.USER_PRESENT` broadcasts. Initially, that receiver is disabled, though — we will only enable it when the user approves our device administrator, so our `DeviceAdminReceiver` implements `onEnabled()` and `onDisabled()` (and registers for the corresponding actions in the manifest) and enables or disables `UnlockReceiver` as needed:

```
package com.commonware.watchauth;

import android.app.admin.DeviceAdminReceiver;
import android.content.ComponentName;
import android.content.Context;
import android.content.Intent;
import android.content.pm.PackageManager;

public class AuthAdminReceiver extends DeviceAdminReceiver {
    @Override
    public void onEnabled(Context ctxt, Intent intent) {
        controlUnlockReceiver(ctxt, true);
    }
}
```



## ACCESSORY CATALOG: SONY SMARTWATCH

---

```
}

@Override
public void onDisabled(Context ctxt, Intent intent) {
    controlUnlockReceiver(ctxt, false);
}

private void controlUnlockReceiver(Context ctxt, boolean enabled) {
    PackageManager mgr=ctxt.getPackageManager();
    int state=
        enabled ? PackageManager.COMPONENT_ENABLED_STATE_ENABLED
            : PackageManager.COMPONENT_ENABLED_STATE_DISABLED;

    mgr.setComponentEnabledSetting(new ComponentName(
                                    ctxt,
                                    UnlockReceiver.class),
                                   state, PackageManager.DONT_KILL_APP);
}
}
```

UnlockReceiver simply forwards the request along to AuthDetectionService:

```
package com.commonware.watchauth;

import android.content.BroadcastReceiver;
import android.content.Context;
import android.content.Intent;

public class UnlockReceiver extends BroadcastReceiver {
    @Override
    public void onReceive(Context ctxt, Intent intent) {
        Intent i=new Intent(ctxt, AuthDetectionService.class);

        i.setAction(AuthDetectionService.CMD_UNLOCK);

        ctxt.startService(i);
    }
}
```

AuthDetectionService, therefore, needs to do the following:

- When the user unlocks the device, start a background thread to wait for the user-specified timeout period
- If the timeout occurs, and the user has not tapped on the extension in the SmartWatch, use the DevicePolicyManager to lock the device
- If the user does tap on the extension before the timeout elapses, stop the timeout thread

And, it should stop itself when it is no longer needed (via `stopSelf()`), plus do all of this without screwing up the threading too badly.

## ACCESSORY CATALOG: SONY SMARTWATCH

---

```
package com.commonware.watchauth;

import android.app.Service;
import android.app.admin.DevicePolicyManager;
import android.content.Intent;
import android.content.SharedPreferences;
import android.os.IBinder;
import android.os.SystemClock;
import android.preference.PreferenceManager;

public class AuthDetectionService extends Service {
    static final String CMD_UNLOCK="com.commonware.watchauth.CMD_UNLOCK";
    static final String CMD_VALIDATE=
        "com.commonware.watchauth.CMD_VALIDATE";
    private Timeout timeout=null;
    private int timeoutSeconds=0;

    @Override
    public void onCreate() {
        super.onCreate();

        SharedPreferences prefs=
            PreferenceManager.getDefaultSharedPreferences(this);
        timeoutSeconds=Integer.parseInt(prefs.getString("timeout", "60"));
    }

    @Override
    public int onStartCommand(Intent intent, int flags, int startId) {
        if (CMD_UNLOCK.equals(intent.getAction())) {
            timeout=new Timeout();
            timeout.start();
        }
        else if (CMD_VALIDATE.equals(intent.getAction())) {
            synchronized(this) {
                if (timeout != null) {
                    timeout.interrupt();
                }
            }
        }

        return(START_REDELIVER_INTENT);
    }

    @Override
    public IBinder onBind(Intent arg0) {
        return(null);
    }

    class Timeout extends Thread {
        @Override
        public void run() {
            SystemClock.sleep(timeoutSeconds * 1000);

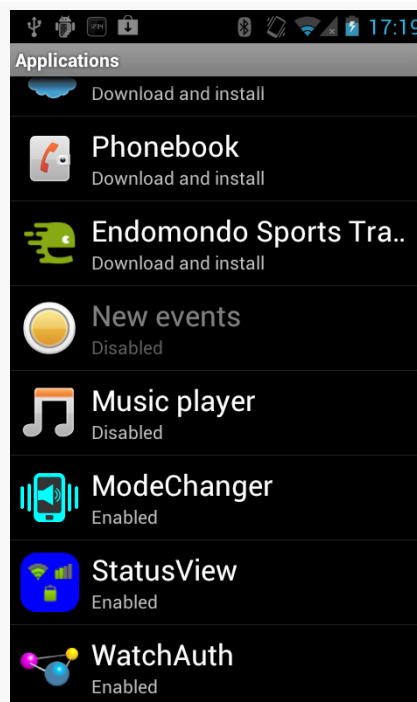
            synchronized(AuthDetectionService.this) {
```

```
if (!isInterrupted()) {
    DevicePolicyManager mgr=
        (DevicePolicyManager) getSystemService(DEVICE_POLICY_SERVICE);

    mgr.lockNow();
    timeout=null;
    stopSelf();
}
}
```

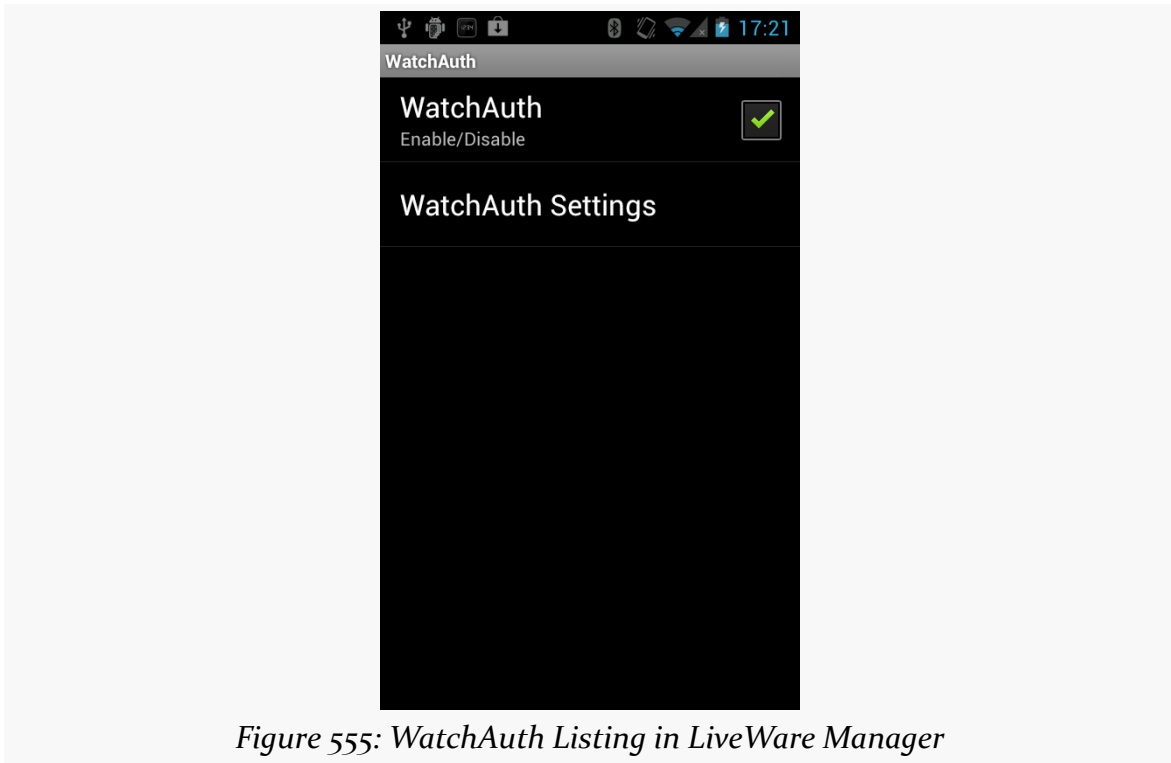
### The Result

If you install the app on a LiveWare-enabled device, you will see WatchAuth appear in the list of installed applications:



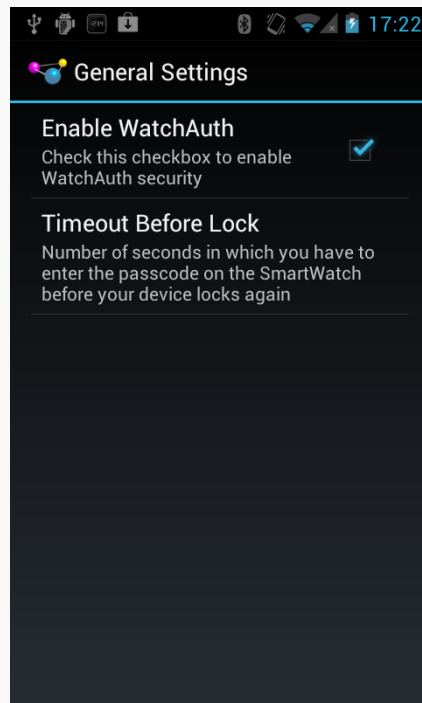
*Figure 554: LiveWare Manager, Showing Installed WatchAuth*

Tapping on the list entry allows you to enable or disable the application, which in the case of WatchAuth only controls whether the app appears on the SmartWatch:



*Figure 555: WatchAuth Listing in LiveWare Manager*

Tapping on “WatchAuth Settings” takes you into a two-tier headers-and-preferences sort of PreferenceActivity, eventually landing you on our PreferenceFragment:



*Figure 556: WatchAuth Preferences*

If the “Enable WatchAuth” checkbox here is checked, then the next time you unlock your device, you will have to go into the SmartWatch, open up the WatchAuth app, and tap on the big orange “Confirm” prompt — otherwise, your device will re-lock automatically after your chosen timeout period.

(in case of development-time emergency, use `adb` to uninstall the app)

## Getting Help

SONY is monitoring [the smartwatch tag on StackOverflow](#), so that is the best place to get your questions answered on SmartWatch development. If you think your question might be more generic to Android, though, be sure to also tag it with the `android` tag.